

# Washington State Register

**AUGUST 5, 1992**

**OLYMPIA, WASHINGTON**

**ISSUE 92-15**



## **IN THIS ISSUE**

Agriculture, Department of  
Asian American Affairs  
Attorney General, Office of the  
Beef Commission  
Bellevue Community College  
Bellingham Technical College  
Building Code Council  
Columbia River Gorge Commission  
Community Development, Department of  
Conservation and Renewable Energy System  
Convention and Trade Center  
Dairy Products Commission  
Eastern Washington University  
Ecology, Department of  
Edmonds Community College  
Education, State Board of  
Egg Commission  
Engineers and Land Surveyors, Board of  
Registration for Professional  
Fisheries, Department of  
Forest Practices Board  
Gambling Commission  
Growth Planning Hearings Boards  
Health, Department of  
Health, State Board of  
Higher Education Coordinating Board  
Highline Community College  
Horse Racing Commission  
Human Rights Commission  
Insurance Commissioner, Office of  
Labor and Industries, Department of

Lake Washington Technical College  
Law Revision Commission  
Legal Foundation of Washington  
Licensing, Department of  
Lottery Commission  
Maritime Commission  
Minority and Women's Business Enterprises,  
Office of  
Natural Resources, Department of  
Parks and Recreation Commission  
Pharmacy, Board of  
Pierce College  
Pilotage Commissioners, Board of  
Public Disclosure Commission  
Public Instruction, Superintendent of  
Psychology, Examining Board of  
Puget Sound Water Quality Authority  
Radiologic Technology Advisory Committee  
Revenue, Department of  
Seattle Community Colleges  
Secretary of State  
Seed Potato Commission  
Social and Health Services, Department of  
South Puget Sound Community College  
Transportation Improvement Board  
University of Washington  
Washington State Patrol  
Whatcom Community College  
Workforce Training and Education Coordinating  
Board

(Subject/Agency index at back of issue)  
This issue contains documents officially  
filed not later than July 22, 1992

## CITATION

Cite all material in the Washington State Register by its issue number and sequence within that issue, preceded by the acronym WSR. Example: the 37th item in the August 5, 1981, Register would be cited as WSR 81-15-037.

## PUBLIC INSPECTION OF DOCUMENTS

A copy of each document filed with the code reviser's office, pursuant to chapter 34.05 RCW, is available for public inspection during normal office hours. The code reviser's office is located on the ground floor of the Legislative Building in Olympia. Office hours are from 8 a.m. to 5 p.m., Monday through Friday, except legal holidays. Telephone inquiries concerning material in the Register or the Washington Administrative Code (WAC) may be made by calling (206) 753-7470 (SCAN 234-7470).

## REPUBLICATION OF OFFICIAL DOCUMENTS

All documents appearing in the Washington State Register are prepared and printed at public expense. There are no restrictions on the republication of official documents appearing in the Washington State Register. All news services are especially encouraged to give wide publicity to all documents printed in the Washington State Register.

## CERTIFICATE

Pursuant to RCW 34.08.040, the publication of rules or other information in this issue of the Washington State Register is hereby certified to be a true and correct copy of such rules or other information, except that headings of public meeting notices have been edited for uniformity of style.

DENNIS W. COOPER  
Code Reviser

---

---

## STATE MAXIMUM INTEREST RATE

(Computed and filed by the State Treasurer under RCW 19.52.025)

The maximum allowable interest rate applicable for the month of August 1992 pursuant to RCW 19.52.020 is twelve point zero percent (12.00%).

NOTICE: FEDERAL LAW PERMITS FEDERALLY INSURED FINANCIAL INSTITUTIONS IN THE STATE TO CHARGE THE HIGHEST RATE OF INTEREST THAT MAY BE CHARGED BY ANY FINANCIAL INSTITUTION IN THE STATE. THE MAXIMUM ALLOWABLE RATE OF INTEREST SET FORTH ABOVE MAY NOT APPLY TO A PARTICULAR TRANSACTION.

---

---

# WASHINGTON STATE REGISTER

(ISSN 0164-6389) is published twice each month by the Statute Law Committee, Office of the Code Reviser, Olympia, WA 98504, pursuant to RCW 34.08.020. Subscription rate is \$161.85 per year, sales tax included, postpaid to points in the United States. Second-class postage paid at Olympia, Washington.

POSTMASTER: SEND ADDRESS CHANGES TO:

WASHINGTON STATE REGISTER  
Code Reviser's Office  
Legislative Building  
Olympia, WA 98504

The Washington State Register is an official publication of the state of Washington. It contains proposed, emergency, and permanently adopted administrative rules, as well as other documents filed with the code reviser's office pursuant to RCW 34.08.020 and 42.30.075. Publication of any material in the Washington State Register is deemed to be official notice of such information.

**Raymond W. Haman**  
*Chairman, Statute Law Committee*

**Dennis W. Cooper**  
*Code Reviser*

**Gary Reid**  
*Chief Assistant Code Reviser*

**Kerry S. Radcliff**  
*Editor*

**Joyce Matzen**  
*Subscription Clerk*

## STYLE AND FORMAT OF THE WASHINGTON STATE REGISTER

### 1. ARRANGEMENT OF THE REGISTER

Documents are arranged within each issue of the Register according to the order in which they are filed in the code reviser's office during the pertinent filing period. The three part number in the heading distinctively identifies each document, and the last part of the number indicates the filing sequence within an issue's material.

### 2. PROPOSED, ADOPTED, AND EMERGENCY RULES OF STATE AGENCIES AND INSTITUTIONS OF HIGHER EDUCATION

The three types of rule-making actions taken under the Administrative Procedure Act (chapter 34.05 RCW) may be distinguished by the size and style of type in which they appear.

- (a) **Proposed rules** are those rules pending permanent adoption by an agency and are set forth in eight point type.
- (b) **Adopted rules** have been permanently adopted and are set forth in ten point type.
- (c) **Emergency rules** have been adopted on an emergency basis and are set forth in ten point oblique type.

### 3. PRINTING STYLE—INDICATION OF NEW OR DELETED MATERIAL

RCW 34.05.395 requires the use of certain marks to indicate amendments to existing agency rules. This style quickly and graphically portrays the current changes to existing rules as follows:

- (a) In amendatory sections—
  - (i) underlined material is new material;
  - (ii) deleted material is (~~lined out and bracketed between double parentheses~~);
- (b) Complete new sections are prefaced by the heading NEW SECTION;
- (c) The repeal of an entire section is shown by listing its WAC section number and caption under the heading REPEALER.

### 4. EXECUTIVE ORDERS, COURT RULES, NOTICES OF PUBLIC MEETINGS

Material contained in the Register other than rule-making actions taken under the APA does not necessarily conform to the style and format conventions described above. The headings of these other types of material have been edited for uniformity of style; otherwise the items are shown as nearly as possible in the form submitted to the code reviser's office.

### 5. EFFECTIVE DATE OF RULES

- (a) Permanently adopted agency rules normally take effect thirty days after the rules and the agency order adopting them are filed with the code reviser's office. This effective date may be delayed or advanced and such an effective date will be noted in the promulgation statement preceding the text of the rule.
- (b) Emergency rules take effect upon filing with the code reviser's office unless a later date is provided by the agency. They remain effective for a maximum of one-hundred-twenty days from the date of filing.
- (c) Rules of the state Supreme Court generally contain an effective date clause in the order adopting the rules.

### 6. EDITORIAL CORRECTIONS

Material inserted by the code reviser's office for purposes of clarification or correction or to show the source or history of a document is enclosed in [brackets].

### 7. INDEX AND TABLES

A combined subject matter and agency index and a table of WAC sections affected may be found at the end of each issue.

1991 - 1992

DATES FOR REGISTER CLOSING, DISTRIBUTION, AND FIRST AGENCY ACTION

Issue No.	Closing Dates <sup>1</sup>			Distribution Date	First Agency Hearing Date <sup>3</sup>
	Non-OTS & 30 p. or more	Non-OTS & 11 to 29 p.	OTS <sup>2</sup> or 10 p. max. Non-OTS	Count 20 days from—	For hearing on or after
For Inclusion in—	File no later than—				
91-16	Jul 10	Jul 24	Aug 7	Aug 21	Sep 10
91-17	Jul 24	Aug 7	Aug 21	Sep 4	Sep 24
91-18	Aug 7	Aug 21	Sep 4	Sep 18	Oct 8
91-19	Aug 21	Sep 4	Sep 18	Oct 2	Oct 22
91-20	Sep 4	Sep 18	Oct 2	Oct 16	Nov 5
91-21	Sep 25	Oct 9	Oct 23	Nov 6	Nov 26
91-22	Oct 9	Oct 23	Nov 6	Nov 20	Dec 10
91-23	Oct 23	Nov 6	Nov 20	Dec 4	Dec 24
91-24	Nov 6	Nov 20	Dec 4	Dec 18	Jan 7, 1992
92-01	Nov 21	Dec 5	Dec 19, 1991	Jan 2, 1992	Jan 22
92-02	Dec 5	Dec 19, 1991	Jan 2, 1992	Jan 15	Feb 4
92-03	Dec 26, 1991	Jan 8, 1992	Jan 22	Feb 5	Feb 25
92-04	Jan 8	Jan 22	Feb 5	Feb 19	Mar 10
92-05	Jan 22	Feb 5	Feb 19	Mar 4	Mar 24
92-06	Feb 5	Feb 19	Mar 4	Mar 18	Apr 7
92-07	Feb 19	Mar 4	Mar 18	Apr 1	Apr 21
92-08	Mar 4	Mar 18	Apr 1	Apr 15	May 5
92-09	Mar 25	Apr 8	Apr 22	May 6	May 26
92-10	Apr 8	Apr 22	May 6	May 20	Jun 9
92-11	Apr 22	May 6	May 20	Jun 3	Jun 23
92-12	May 6	May 20	Jun 3	Jun 17	Jul 7
92-13	May 20	Jun 3	Jun 17	Jul 1	Jul 21
92-14	Jun 3	Jun 17	Jul 1	Jul 15	Aug 4
92-15	Jun 24	Jul 8	Jul 22	Aug 5	Aug 25
92-16	Jul 8	Jul 22	Aug 5	Aug 19	Sep 8
92-17	Jul 22	Aug 5	Aug 19	Sep 2	Sep 22
92-18	Aug 5	Aug 19	Sep 2	Sep 16	Oct 6
92-19	Aug 26	Sep 9	Sep 23	Oct 7	Oct 27
92-20	Sep 9	Sep 23	Oct 7	Oct 21	Nov 10
92-21	Sep 23	Oct 7	Oct 21	Nov 4	Nov 24
92-22	Oct 7	Oct 21	Nov 4	Nov 18	Dec 8
92-23	Oct 21	Nov 4	Nov 18	Dec 2	Dec 22
92-24	Nov 4	Nov 18	Dec 2	Dec 16	Jan 5, 1993

<sup>1</sup>All documents are due at the code reviser's office by 12:00 noon on or before the applicable closing date for inclusion in a particular issue of the Register; see WAC 1-21-040.

<sup>2</sup>A filing of any length will be accepted on the closing dates of this column if it has been prepared and completed by the order typing service (OTS) of the code reviser's office; see WAC 1-21-040. Agency-typed material is subject to a ten page limit for these dates; longer agency-typed material is subject to the earlier non-OTS dates.

<sup>3</sup>At least twenty days before the rule-making hearing, the agency shall cause notice of the hearing to be published in the Register; see RCW 34.05.320(1). These dates represent the twentieth day after the distribution date of the applicable Register.



**WSR 92-13-017**  
**RULES OF COURT**  
**STATE SUPREME COURT**  
 [June 4, 1992]

IN THE MATTER OF THE ADOPTION  
 OF THE AMENDMENTS TO RPC 1.10(a), ORDER  
 (b), APR 3(c), RLD TABLE OF RULES, NO. 25700-A-501  
 RLD 1.1, RLD 2.2, RLD 2.3, RLD  
 2.4, RLD 2.6, RLD 2.7, RLD 2.8,  
 RLD 2.9, RLD 3.1, RLD 3.2, RLD  
 4.1, RLD 4.3, RLD 4.4, RLD 4.6,  
 RLD 4.7, RLD 4.10, RLD 4.10a, RLD  
 4.11, RLD 4.12, RLD 4.13, RLD  
 4.14, RLD 5.2, RLD 5.3, RLD 5.5,  
 RLD 5.5A, RLD 5.6, RLD 5.7, RLD  
 6.1, RLD 6.2, RLD 6.3, RLD 6.5,  
 RLD 6.6, RLD 6.7, RLD 6.8, RLD 7.3,  
 RLD 7.5, RLD 7.6, RLD 9.1, RLD 9.3,  
 RLD 9.4, RLD 9.5, RLD 9.6, RLD  
 10.3, RLD 11.1, RLD 11.1(1), RLD  
 11.2, RLD 12.1, RLD 12.2, RLD 12.8,  
 RLD 12.9, RLD 12.11, RLD 12.13, RLD  
 13.3, RLD 13.5, ER 104(c), (d), ER  
 404, ER 405(b), ER 411, COMMENT TO  
 ER 412, ER 501, COMMENT TO ER 501,  
 COMMENT TO ER 601, ER 602, ER 603,  
 ER 604, COMMENT TO ER 604, ER 606,  
 ER 607, ER 608(b), COMMENT TO ER  
 609(a), ER 610, ER 611(c), ER 612,  
 ER 613, ER 615, ER 701, ER 703, ER  
 705, ER 706(a), ER 801(a), (d), ER  
 803(a), ER 804, ER 806, COMMENT TO  
 ER 807, ER 902(b), (c), (d),  
 COMMENT TO ER 902 (d), ER 1004(c),  
 ER 1007, ER 1101 (c), (d), COMMENT  
 TO ER 1101(d), RAP 16.1(g), NEW  
 RAP 16.18, CR 26(i), CR 37(a),  
 CR 77(h), APR (3)(b), APR 11.2,  
 APR 11.6(a), REGULATIONS 102, 103,  
 109, 114, 115, AND CrRLJ 3.2(m)

The Washington State Bar Association having recom-  
 mended the adoption of the amendments to RPC  
 1.10(a), (b), APR 3(c), RLD Table of Rules, RLD 1.1,  
 RLD 2.2, RLD 2.3, RLD 2.4, RLD 2.6, RLD 2.7, RLD  
 2.8, RLD 2.9, RLD 3.1, RLD 3.2, RLD 4.1, RLD 4.3,  
 RLD 4.4, RLD 4.6, RLD 4.7, RLD 4.10, RLD 4.10A,  
 RLD 4.11, RLD 4.12, RLD 4.13, RLD 4.14, RLD 5.2,  
 RLD 5.3, RLD 5.5, RLD 5.5A, RLD 5.6, RLD 5.7,  
 RLD 6.1, RLD 6.2, RLD 6.3, RLD 6.5, RLD 6.6, RLD  
 6.7, RLD 6.8, RLD 7.3, RLD 7.5, RLD 7.6, RLD 9.1,  
 RLD 9.3, RLD 9.4, RLD 9.5, RLD 9.6, RLD 10.3,  
 RLD 11.1, RLD 11.1(1), RLD 11.2, RLD 12.1, RLD  
 12.2, RLD 12.8, RLD 12.9, RLD 12.11, RLD 12.13,  
 RLD 13.3, RLD 13.5, ER 104(c), (d), ER 404, ER  
 405(b), ER 411, Comment to ER 412, ER 501, Com-  
 ment to ER 501, Comment to ER 601, ER 602, ER 603,  
 ER 604, Comment to ER 604, ER 606, ER 607, ER  
 608(b), Comment to ER 609(a), ER 610, ER 611(c),  
 ER 612, ER 613, ER 615, ER 701, ER 703, ER 705,  
 ER 706(a), ER 801(a), (d), ER 803(a), ER 804, ER  
 806, Comment to ER 807, ER 902(b), (c), (d), Com-  
 ment to ER 902(d), ER 1004(c), ER 1007, ER 1101(c),  
 (d), Comment to ER 1101(d), RAP 16.1(g), New RAP  
 16.18, CR 26(i), CR 37(a), CR 77(h), APR 3(b), APR  
 11.2, APR 11.6(a), Regulations 102, 103, 109, 114  
 AND 115, and CrRLJ 3.2(m), and the Court having

considered the proposed new rule, amendments, regula-  
 tions and comments submitted thereto, and having de-  
 termined that the proposed new rule, amendments and  
 regulations will aid in the prompt and orderly adminis-  
 tration of justice;

Now, therefore, it is hereby

**ORDERED:**

(a) That the proposed new rule, amendments and reg-  
 ulations as attached hereto are adopted;

(b) That the new rule, amendments and regulations  
 will be published in the special rules edition of the  
 Washington Reports in July, 1992, and will become ef-  
 fective September 1, 1992.

DATED at Olympia, Washington this 4th day of  
 June, 1992.

Fred H. Dore

Robert F. Utter

Robert F. Brachtenbach

Durham, J.

Charles Z. Smith

James M. Dolliver

Richard P. Guy

James A. Anderson

Johnson, J.

RPC 1.10(a), (b)

(a) While Except as provided in section (b), while  
 lawyers are associated in a firm, none of them shall  
 knowingly represent a client when any one of them  
 practicing alone would be prohibited from doing so by  
 rules 1.7, 1.8(c), 1.9, or 2.2.

(b) When a lawyer becomes associated with a firm,  
 the firm may not knowingly represent a person in the  
 same or a substantially related matter in which that  
 lawyer ("the personally disqualified lawyer"), or a firm  
 with which the lawyer was associated, had previously  
 represented a client whose interests are materially ad-  
 verse to that person and about whom the lawyer had ac-  
 quired confidences or secrets protected by rules 1.6 and  
 1.9(b) that are material to the matter; provided that the  
prohibition on the firm shall not apply if:

(1) The personally disqualified lawyer is screened by  
effective means from participation in the matter and is  
apportioned no part of the fee therefrom;

(2) The former client of the personally disqualified  
lawyer receives notice of the conflict and the screening  
mechanism used to prohibit dissemination of confidential  
or secret information;

(3) The firm is able to demonstrate by convincing evi-  
dence that no confidences or secrets that are material  
were transmitted by the personally disqualified lawyer  
before implementation of the screening mechanism and  
notice to the former client.

Any presumption that confidences or secrets of the  
former client have been or will be transmitted may be  
rebutted if the personally disqualified lawyer serves on  
his or her former law firm and former client an affidavit  
attesting that the personally disqualified lawyer will not  
participate in the matter and will not discuss the matter  
or the representation with any other lawyer or employee  
of his or her current law firm, and attesting that during

the period of the lawyer's personal disqualification those lawyers or employees who do participate in the matter will be apprised that the personally disqualified lawyer is screened from participating in or discussing the matter. Such affidavit shall describe the procedures being used effectively to screen the personally disqualified lawyer. Upon request of the former client, such affidavit shall be updated periodically to show actual compliance with the screening procedures. The law firm, the personally disqualified lawyer, or the former client may seek judicial review in a court of general jurisdiction of the screening mechanism used, or may seek court supervision to ensure that implementation of the screening procedures has occurred and that effective actual compliance has been achieved.

APR 3(c)

(c) Exceptions. The Board of Governors may, in its discretion, withhold permission for an otherwise qualified person to sit for the bar examination, until completion of an inquiry into the applicant's character and fitness, if the applicant (i) has ever been convicted of a "serious crime" as defined in RLD 3.1(h), or (ii) has ever been disbarred or is presently suspended from the practice of law for disciplinary reasons in any jurisdiction, or (iii) has previously been denied admission to the bar in this or any other jurisdiction for reasons other than failure to pass a bar examination. The Board of Governors may also withhold permission to sit for the bar examination where for any other reason there are serious and substantial questions regarding the present moral character or fitness of the applicant. The Board of Governors may refer such matters to the Character and Fitness Committee for investigation and hearing pursuant to rule 7.

RULES FOR LAWYER DISCIPLINE (RLD)

TABLE OF RULES

TITLE 1  
 GROUNDS AND JURISDICTION

Rule

- 1.1 Grounds for Discipline
- 1.2 Jurisdiction

TITLE 2  
 STRUCTURE AND DUTIES

- 2.1 Supreme Court
- 2.2 Board of Governors
- 2.3 Disciplinary Board
- 2.4 Review Committees
- 2.5 Hearing Officer or Panel
- 2.6 ~~State Bar~~ Disciplinary Counsel
- 2.7 Special District Counsel
- 2.8 Respondent Lawyer
- 2.9 Complainant Grievant

TITLE 3  
 SUSPENSION BEFORE FINAL DISPOSITION

- 3.1 Suspension for Conviction of a Crime
- 3.2 Suspension in Other Circumstances

TITLE 4

HEARING PROCEDURES AND STIPULATIONS

- 4.1 Application of Civil Rules
- 4.2 Appointment of Hearing Officer or Panel
- 4.3 Commencement of Proceedings
- 4.4 Notice To Answer
- 4.5 Answer
- 4.6 Amendment of Formal Complaint
- 4.7 Discovery
- 4.8 Motions
- 4.9 Proceeding Based on Criminal Conviction
- 4.10 Disciplinary Hearing
- 4.10A Default Proceedings
- 4.11 Evidence and Burden of Proof
- 4.12 Prior Disciplinary Record
- 4.13 Decision of Hearing Officer or Panel
- 4.14 Stipulations

TITLE 5

SANCTIONS AND OTHER REMEDIES

- 5.1 Sanctions
- 5.2 Probation
- 5.3 Restitution
- 5.4 Suspension for Cumulative Discipline
- 5.5 Administration of Censure and Reprimand
- 5.5A Admonition
- 5.5B Discipline for Cumulative Admonitions
- 5.6 Advisory Letter
- 5.7 Costs and Expenses

TITLE 6

REVIEW BY BOARD

- 6.1 Decisions Subject to Board Review
- 6.2 Review of Suspension or Disbarment Recommendation
- 6.3 Appeal by Respondent Lawyer or ~~State Bar~~ Disciplinary Counsel
- 6.4 Reference to Record
- 6.5 Request To Reopen Proceedings
- 6.6 Transcript of Hearing
- 6.7 Decision of Board
- 6.8 Chairperson May Modify Requirements

TITLE 7

REVIEW BY SUPREME COURT

- 7.1 Methods of Seeking Review
- 7.2 Appeal
- 7.3 Discretionary Review
- 7.4 Applicability of Rules of Appellate Procedure
- 7.5 Record to Supreme Court
- 7.6 Briefs
- 7.7 Argument
- 7.8 Opinion
- 7.9 Violation of Rules

TITLE 8

PROTECTION OF PUBLIC WHEN LAWYER UNABLE TO ACT

- 8.1 Notice to Clients and Others
- 8.2 Lawyer To Discontinue Practice
- 8.3 Affidavit of Compliance
- 8.4 Public Notice

- 8.5 Lawyer To Keep Records of Compliance  
 8.6 Appointment of Counsel To Protect Clients' Interests

## TITLE 9

## REINSTATEMENT AFTER DISBARMENT

- 9.1 Restrictions Against Petitioning  
 9.2 Reversal of Conviction  
 9.3 ~~Form of Petition~~ Character and Fitness Committee  
 9.4 ~~Investigation~~ Petitions and Investigations  
 9.5 ~~Hearing Before Board of Governors~~ Character and Fitness Committee  
 9.6 ~~Action by Board of Governors~~ Character and Fitness Committee  
 9.7 Action on Supreme Court's Determination

## TITLE 10

## TRANSFER TO DISABILITY INACTIVE STATUS

- 10.1 Automatic Transfer  
 10.2 Discretionary Transfer  
 10.3 Reinstatement to Active Status

## TITLE 11

## ACCESS TO DISCIPLINARY INFORMATION

- 11.1 Pending Investigations and Proceedings  
 11.2 Notice of Discipline

## TITLE 12

## GENERAL PROVISIONS

- 12.1 Service of Papers  
 12.2 Filing; Copy to Hearing Officer; Orders  
 12.3 Papers  
 12.4 Expenses  
 12.5 Restrictions on Representation of Respondent  
 12.6 Reciprocal Discipline  
 12.7 Removal of Appointees  
 12.8 Maintenance of Records  
 12.9 Confidential Sources  
 12.10 Statute of Limitation  
 12.11 Exoneration From Liability  
 12.12 Computation of Time  
 12.13 Stipulation to Extension of Time  
 12.14 Priorities  
 12.15 Definitions  
 12.16 Effect on Pending Proceedings  
 12.17 Lawyers' Assistance Program; Confidentiality

## TITLE 13

## AUDITS AND TRUST ACCOUNT OVERDRAFT NOTIFICATION

- 13.1 Audit and Investigation of Books and Records  
 13.2 Cooperation of Lawyer  
 13.3 Disclosure  
 13.4 Trust Account Overdraft Notification  
 13.5 Declaration or Questionnaire  
 13.6 Regulations

## TITLE 1

## GROUNDS AND JURISDICTION

## RULE 1.1

## GROUNDS FOR DISCIPLINE

A lawyer may be subjected to the disciplinary sanctions or actions set forth in these rules for any of the following:

(a) The commission of any act involving moral turpitude, dishonesty, or corruption, or any unjustified act of assault or other act which reflects disregard for the rule of law, whether the same be committed in the course of his or her conduct as a lawyer, or otherwise, and whether the same constitutes a felony or misdemeanor or not; and if the act constitutes a felony or misdemeanor, conviction thereof in a criminal proceeding shall not be a condition precedent to disciplinary action, nor shall acquittal or dismissal thereof preclude the commencement of a disciplinary proceeding;

(b) Willful disobedience or violation of a court order directing him or her to do or cease doing an act which he or she ought in good faith to do or forbear;

(c) Violation of his or her oath or duties as a lawyer;

(d) Willfully purporting to act as a lawyer for any person without the authority of that person;

(e) Permitting his or her name to be used as a lawyer by another person who is not a lawyer authorized to practice law in the state of Washington;

(f) Misrepresentation or concealment of a material fact made in his or her application for admission to the bar or admission to the bar examination or reinstatement or in support thereof;

(g) Suspension, disbarment or other disciplinary sanction by competent authority in any state, federal or foreign jurisdiction;

(h) Practicing law with or in cooperation with a disbarred or suspended lawyer, or maintaining an office for the practice of law in a room or office occupied or used in whole or in part by a disbarred or suspended lawyer, or permitting a disbarred or suspended lawyer to use his or her name for the practice of law, or practicing law for or on behalf of a disbarred or suspended lawyer, or practicing law under any arrangement or understanding for division of fees or compensation of any kind with a disbarred or suspended lawyer;

(i) Violation of the Rules of Professional Conduct of the profession adopted by the Supreme Court of the State of Washington;

(j) Violation of duties imposed by these rules, including but not limited to violation of rule 2.8, failing to respond to inquiries or requests regarding matters under investigation; rule 4.5, failing to file an answer to a formal complaint; rule 4.6(c), failing to file an answer to an amendment to a formal complaint; rule 4.7(e), failing to cooperate with discovery; rule 4.10(g), failing to attend a hearing or failing to bring materials requested by state bar disciplinary counsel; rule 5.5(b), failing to appear to receive a reprimand; rule 8.1; failing to notify clients and others of inability to act; rule 8.2, failing to discontinue practice; rule 8.3, failing to file an affidavit of compliance; rule 11.1(l), wrongful disclosure; rule 13.2, failing to cooperate with an examination of books and records; rule 13.4(d), failing to notify Association of trust account overdraft; rule 13.5, failing to file a declaration or questionnaire certifying compliance with RPC 1.14;

(k) Violation of the Code of Judicial Conduct;

(l) Engaging in the practice of law while on inactive status, or while suspended from the practice of law for any cause;

(m) Failure to meet conditions of probation imposed pursuant to rule 5.2, or conditions of a stipulation approved pursuant to rule 4.14;

(n) Willful failure to pay restitution where required pursuant to rule 5.3, or to pay costs where required pursuant to rule 2.8(b) or rule 5.7;

(o) Attempting to commit an act, or assisting another in committing or attempting to commit an act, which if completed would be prohibited by this rule;

(p) Conduct demonstrating unfitness to practice law.

#### RULE 1.2 JURISDICTION

A lawyer admitted to the practice of law in this state, and any lawyer specially admitted by a court of this state for a particular case, shall be subject to these Rules for Lawyer Discipline. Jurisdiction shall continue whether or not the lawyer retains the authority to practice law in this state, and regardless of the residence of the lawyer.

### TITLE 2 STRUCTURE AND DUTIES

#### RULE 2.1 SUPREME COURT

The Supreme Court of Washington has exclusive responsibility within the state for the administration of the lawyer discipline and disability system and has inherent power to maintain appropriate standards of professional conduct and to dispose of individual cases of lawyer discipline and disability. Persons carrying out the functions set forth in these rules are acting under the authority of the Supreme Court.

#### RULE 2.2 BOARD OF GOVERNORS

(a) Authority. The Board of Governors of the Association shall have the power and authority to:

(1) Supervise the general functioning of the Disciplinary Board, review committees, ~~state bar~~ disciplinary counsel, bar staff and special district counsel;

(2) Make appointments, remove persons appointed, and fill vacancies as provided in these rules;

(3) Consider petitions for reinstatement after disbarment pursuant to Title 9;

(4) Perform such other functions and take such other actions as provided in these rules or as may be delegated to it by the Supreme Court or as may be necessary and proper to carry out its duties.

(b) Limitation of Authority. The Board of Governors shall have no right or responsibility to review decisions or recommendations of a hearing officer or panel or of the Disciplinary Board in specific cases except as provided in rule 7.3(c).

#### RULE 2.3 DISCIPLINARY BOARD

(a) Membership.

(1) Composition. The Board shall consist of not less than three nonlawyer members, appointed by the Supreme Court, and not less than one lawyer member from each congressional district, appointed by the Board of Governors.

(2) Qualifications. Lawyer members must have been active members of the Association for at least 7 years.

(3) Quorum. A majority of the Board members shall constitute a quorum. Given a quorum, the concurrence of a majority of those present shall constitute action of the Board.

(4) Disqualification. In the event a complaint grievance is ~~made to filed with~~ the Association alleging an act of misconduct by a lawyer member of the Board, such member shall take a leave of absence from the Board until the matter is resolved, unless otherwise directed by the Board of Governors. If a disciplinary sanction is imposed against the member, he or she shall be ineligible to serve further on the Board. The resulting vacancy shall be filled as set forth in section (d).

(5) Voting. Each member, whether nonlawyer or lawyer, shall have one vote.

(b) Terms of Office. The term of office for a member of the Board shall be 3 years. Newly created Board positions may be filled by appointments of less than 3 years, as designated by the court or the Board of Governors, to permit as equal a number of positions as possible to be filled each year. All terms of office begin October 1 and end September 30 or when a successor has been appointed, whichever occurs later. Members may not serve more than one term except as otherwise provided in these rules. Members heretofore appointed shall continue to serve until replaced.

(c) Chairperson. The Board of Governors shall annually designate one lawyer member of the Board to act as chairperson and another as vice-chairperson. The vice-chairperson shall serve in the absence of or at the request of the chairperson.

(d) Vacancies. Vacancies in lawyer membership on the Board and in the office of the chairperson and the vice-chairperson shall be filled by the Board of Governors. Vacancies in nonlawyer membership shall be filled by the Supreme Court. A person appointed to fill a vacancy shall complete the unexpired term of the person he or she replaces, and if that unexpired term is less than 18 months he or she may be reappointed to a consecutive term.

(e) Pro Tempore Members. When a member of the Board is disqualified or unable to function on a case for good cause, the chairperson of the Board may, by written order, designate a member pro tempore to sit with the Board to hear and determine the cause. A member pro tempore may be appointed from among those persons who have previously served as members of the Disciplinary Board, or from among lawyers appointed as alternate Board members by the Board of Governors and nonlawyers appointed as alternate Board members by

the Supreme Court. A lawyer shall be appointed to substitute for a lawyer member of the Board, and a non-lawyer to substitute for a nonlawyer member of the Board.

(f) Authority of Board. The Board shall have the power and authority to:

(1) Review each proceeding in which a recommendation of disbarment, suspension, or transfer to disability inactive status has been made by a hearing officer or panel;

(2) Review each proceeding in which a recommendation other than disbarment or suspension from the practice of law has been made by a hearing officer or panel, including a recommendation of dismissal, upon an appeal filed pursuant to rule 6.1(b);

(3) Review stipulations entered into pursuant to rule 4.14 when such stipulations provide for suspension or disbarment;

(4) Review any prehearing ruling of a hearing officer or panel, upon request for review by either the respondent lawyer or ~~state-bar~~ disciplinary counsel, where the chairperson of the Board determines that such review is necessary and appropriate and will serve the ends of justice;

(5) Review the decision of a review committee dismissing allegations of misconduct by a lawyer when such review is directed by the chairperson of the Board, and upon such review order a hearing on the alleged misconduct, dismiss the matter, issue an advisory letter pursuant to rule 5.6, issue an admonition pursuant to rule 5.5A, or order such further investigation as may appear appropriate;

(6) Perform such other functions and take such other actions as provided in these rules or as may be delegated to it by the Board of Governors or Supreme Court, or as may be necessary and proper to carry out its duties.

(g) Meetings. The Board shall hold meetings at such times and places as it may determine. Where the chairperson of the Board determines that prompt action is necessary for protection of the public, and that circumstances do not permit a full meeting of the Board, the Board may vote on a matter otherwise ready for review without meeting together, through telephone or written communication.

(h) Clerk. The Executive Director of the Association, under the direction of the Board of Governors, may appoint a suitable person or persons to act as clerk to the Board, to assist the Board and the review committees in carrying out their functions under these rules.

#### RULE 2.4 REVIEW COMMITTEES

(a) Membership. The chairperson of the Board shall appoint three or more review committees of three members each from among the members of the Board. Each review committee shall consist of two lawyers and one nonlawyer. The chairperson of the Board may reassign members among the several committees on an interim or permanent basis. The chairperson of the Board shall not serve on a review committee.

(b) Chairperson. The chairperson of the Board shall designate one member of each review committee to act as its chairperson.

(c) Terms of Office. A member of a review committee shall serve until his or her term of office on the Board expires.

(d) Authority of Review Committees. Each review committee shall have the power and authority to:

(1) Review reports on investigations of alleged acts of misconduct by a lawyer, and upon such review order a hearing on the alleged misconduct, issue an admonition, dismiss the matter, issue an advisory letter, or direct such further investigation as may appear appropriate;

(2) Order that an investigation into an alleged act of misconduct by a lawyer be deferred when it appears that the allegations are substantially similar to those in pending civil or criminal litigation, or when the lawyer complained against whom a grievance is filed is physically or mentally unable to respond to the investigation, or for other good cause, where it appears that such deferral will not endanger the public;

(3) Review reports on investigations into allegations that a lawyer is mentally or physically unable to conduct the practice of law, and upon such review order a hearing into the capacity of the lawyer to conduct the practice of law, dismiss the matter, or direct such further investigation as may appear appropriate;

(4) Reconsider complaints grievances conditionally dismissed by ~~state-bar~~ disciplinary counsel, when the complainant grievant has disputed the dismissal and the complaint grievance has not been reopened, and upon such reconsideration affirm the dismissal, order a hearing on the alleged misconduct, issue an advisory letter, or direct such further investigation as may appear appropriate;

(5) Review stipulations entered into pursuant to rule 4.14, other than stipulations for suspension or disbarment, and approve or reject such stipulations;

(6) Make determinations of whether a crime is a "serious crime" under rule 3.1 and authorize proceedings for suspension of a lawyer upon finding of risk to the public pursuant to rule 3.2(a);

(7) Perform such other functions and take such other actions as provided in these rules or as may be delegated to it by the Disciplinary Board or the Board of Governors, or as may be necessary and proper to carry out its duties.

(e) Distribution of Cases. The clerk of the Board if one has been appointed, or ~~state-bar~~ disciplinary counsel, shall have the responsibility of transmitting matters to the several review committees under direction of the chairperson of the Board so as to equalize the case load of the committees to the extent possible.

(f) Meetings. Each review committee shall meet at such times and places as determined by the committee chairperson, under the general direction of the chairperson of the Board. A review committee may also conduct business and take action by conference call or through written communication without meeting together where the chairperson of the committee determines that prompt action is necessary.

RULE 2.5  
HEARING OFFICER OR PANEL

(a) Eligibility. Hearing officers shall be assigned to cases from a list of lawyers maintained by the Board of Governors. The list shall include all lawyer members of the Disciplinary Board, and shall also include as many additional lawyers as the Board of Governors considers necessary to carry out the provisions of these rules effectively and efficiently.

(b) Qualifications. Appointment by the Board of Governors to the hearing officer list shall be made from among lawyers who have been active members of the Association for at least 7 years.

(c) Hearing Panel. When a hearing panel is assigned to hear a matter, the panel shall consist of three persons on the hearing officer list, or two such persons plus a nonlawyer. If the third member of a hearing panel is to be a nonlawyer, he or she shall be assigned from a list of suitable persons willing to serve in that capacity to be maintained by the Board of Governors. Such list may include the nonlawyer members of the Disciplinary Board, at the option of those members.

(d) Terms of Appointment. Appointment by the Board of Governors to the hearing officer list, or to the list of nonlawyers maintained pursuant to section (c), shall be for a period of 3 years and shall be subject to reappointment at the discretion of the Board of Governors. Eligibility of a member of the Disciplinary Board to serve as a hearing officer or panel member shall be concurrent with his or her term on the Board. Notwithstanding the provisions of this rule, a hearing officer or panel member shall have authority to act in any matter assigned to him or her prior to the expiration of his or her appointment or term.

(e) Duty. It shall be the duty of the hearing officer or panel to whom a case has been assigned for hearing to conduct the hearing as hereinafter provided.

RULE 2.6  
~~STATE-BAR~~ DISCIPLINARY COUNSEL

(a) Appointment. The Executive Director of the Association, under the direction of the Board of Governors, shall employ a suitable person or persons from among the members of the Association to act as counsel for the Association with respect to matters under these rules. Special ~~state-bar~~ disciplinary counsel may be appointed whenever necessary to conduct an individual investigation or proceeding.

(b) Duties. It shall be the duty of ~~state-bar~~ disciplinary counsel to:

(1) Take cognizance of any alleged or apparent act of misconduct by a lawyer, whether by complaint grievance or otherwise, and investigate the same or assign the same for investigation to special district counsel;

(2) Assist in investigations conducted by special district counsel;

(3) Report results of investigations, except those conditionally dismissed, to a review committee;

(4) Conduct such additional investigation as a review committee may request;

(5) Act as counsel on behalf of the Association on all matters coming within these rules;

(6) Perform such other duties as shall be required by the Executive Director or the Board of Governors.

(c) Conditional Dismissals. ~~State-bar~~ Disciplinary counsel shall have power conditionally to dismiss allegations of misconduct. A complainant grievant may dispute such a conditional dismissal, in which case ~~state-bar~~ disciplinary counsel may either reopen the matter for investigation, or may refer the case to a review committee for reconsideration of the conditional dismissal.

(d) Discovery Prior to Formal Complaint. Where ~~state-bar~~ disciplinary counsel deems it advisable prior to the filing of a formal complaint to conduct the deposition of a lawyer being investigated or of a witness, or to issue requests for admission to a lawyer being investigated, he or she may do so.

(1) Procedure. Depositions pursuant to this rule shall be conducted in conformity with CR 30 or 31 to the extent possible. Requests for admission shall be governed by CR 36.

(2) Subpoenas for Depositions. A lawyer member of the Board or ~~state-bar~~ disciplinary counsel shall have the power to issue subpoenas to compel the attendance of the lawyer being investigated or of a witness, or the production of books, or documents, or other evidence, at the taking of a deposition. Subpoenas shall be served in the same manner as in civil cases in the superior court.

RULE 2.7  
SPECIAL DISTRICT COUNSEL

(a) Appointment and Term of Office. The Board of Governors shall appoint one or more special district counsel in each congressional district of the state, from among the active members of the Association in good standing practicing in the district. The term of office for each special district counsel shall be 3 years. Special district counsel may be reappointed for consecutive terms.

(b) Duties. It shall be the duty of special district counsel to:

(1) Assist ~~state-bar~~ disciplinary counsel when requested in investigating allegations of misconduct by a lawyer, whether or not the lawyer resides or practices in the same congressional district;

(2) Forward to ~~state-bar~~ disciplinary counsel complaints grievances alleging misconduct by a lawyer;

(3) Investigate at the request of a review committee any complaint grievance of misconduct brought against ~~state-bar~~ disciplinary counsel and report the same directly to the review committee.

(c) Review by ~~State-Bar~~ Disciplinary Counsel. Upon receiving a report of an investigation conducted by a special district counsel, ~~state-bar~~ disciplinary counsel may request additional investigation, may conduct any additional investigation as may appear necessary, and may take any action under rule 2.6 as appears appropriate.

RULE 2.8  
RESPONDENT LAWYER

(a) Duty To Furnish Prompt Response. It is the duty of every lawyer promptly to respond to any inquiry or request made pursuant to these rules for information

relevant to complaints, grievances or matters under investigation concerning conduct of a lawyer. Upon such inquiry or request, every lawyer:

(1) Shall furnish in writing, or orally if requested, a full and complete response to inquiries and questions;

(2) Shall permit inspection and copying of his or her business records, files and accounts;

(3) Shall furnish copies of requested records, files and accounts;

(4) Shall furnish written releases or authorizations where needed to obtain access to documents or information in the possession of third parties, including in the case of inquiries into the physical or mental capacity of a lawyer written releases or authorizations needed to obtain access to medical, psychiatric, psychological or other relevant records and opinions; and

(5) Shall comply with discovery conducted pursuant to rule 2.6.

(b) Failure To Cooperate. When a lawyer has failed to comply with any request made pursuant to section (a) for more than 30 days, state-bar disciplinary counsel may notify the lawyer that failure to so comply within 10 days may necessitate the taking of the deposition of the lawyer pursuant to subpoena.

(1) Any deposition conducted after the expiration of that 10-day period and necessitated by the continued failure to cooperate by the lawyer may be conducted at any place within the state of Washington.

(2) A lawyer whose failure to cooperate has resulted in a subpoena being served for a deposition to be conducted pursuant to the preceding subsection shall be liable for the actual costs of that deposition, including but not limited to service fees, court reporter fees, travel expenses and the cost of transcribing the deposition, if ordered by state-bar disciplinary counsel, regardless of the ultimate disposition of the underlying complaint grievance. In addition, a lawyer whose failure to cooperate has resulted in service of a subpoena for a deposition shall be liable for the expense of a reasonable attorney fee of \$200. Upon application of state-bar disciplinary counsel to a review committee itemizing the costs and expenses and setting forth the reasons necessitating the deposition, and after giving the lawyer 10 days to respond, the review committee shall by order assess such costs and expenses as appear appropriate against the lawyer. Board review of an order assessing costs and expenses under this rule may be conducted in the same manner and under the same terms as review under rule 5.7(e).

(3) Failure of a lawyer to cooperate fully and promptly with an investigation as required by section (a) of this rule shall also constitute grounds for discipline.

(c) Privilege Against Self-Incrimination. The duty of a lawyer to cooperate during the course of an investigation shall be subject to the lawyer's proper exercise of his or her privilege against self-incrimination, where applicable.

(d) Attorney-Client Privilege. A lawyer may not assert the attorney-client privilege or other prohibitions on revealing client confidences or secrets as a ground for refusing to provide information during the course of an investigation, but any information obtained during an

investigation which involves client confidences or secrets shall be kept confidential to the extent possible under these rules unless the client otherwise consents.

(e) Right to Representation. A lawyer may be represented by counsel during any stage of an investigation or proceeding under these rules.

#### RULE 2.9

#### COMPLAINANT GRIEVANT

(a) Rights. Any person filing a complaint grievance with the Association alleging an act of misconduct by a lawyer shall have the right to:

(1) Be advised promptly of the receipt of the complaint grievance, and of the name, address and office phone number of the person assigned to its investigation if such an assignment is made;

(2) Request reconsideration by a review committee of a conditional dismissal of the complaint grievance by state-bar disciplinary counsel or reconsideration by the Board of a dismissal of the complaint grievance by a review committee when the chairperson of the Board so directs;

(3) Have a reasonable opportunity to speak with the investigator assigned to the complaint grievance, by telephone or in person, concerning the substance of the complaint grievance or its status;

(4) Receive a copy of any response submitted by the lawyer ~~complained against~~ against whom a grievance is filed, except when that response makes reference to confidences or secrets of a client of the lawyer to which the complainant grievant is not privy, or contains information of a personal and private nature regarding the lawyer, or when a review committee determines that the interests of justice would better be served if the response is not released;

(5) Submit additional supplemental written information or documentation at any time;

(6) Attend any hearing conducted into the complaint grievance, subject to the applicable rules of evidence and any protective order issued pursuant to rule 11.1(f);

(7) Testify as a witness at any hearing conducted into the complaint grievance, subject to the applicable rules of evidence and any protective order issued pursuant to rule 11.1(f);

(8) Be advised of the disposition of the complaint grievance.

(b) Duties. A person filing a complaint grievance shall have the duty to furnish the person assigned to its investigation with documentary evidence in his or her possession, and the names and addresses of witnesses; to assist in securing evidence in relation to the facts charged; and to appear and testify at any hearing resulting from the complaint grievance. Failure to fulfill these duties may be grounds for dismissal of a complaint grievance.

(c) Consent to Disclosure. The filing of a complaint grievance shall constitute consent to disclose the content of the complaint grievance to the lawyer or to any other person contacted during the investigation of the complaint grievance, unless the complainant grievant specifically withholds such consent. The filing of a complaint grievance shall also constitute consent to disclosure by the lawyer complained against, or by any other lawyer

contacted by the complainant grievant, of any information relevant to the investigation of the complaint grievance, unless the complainant grievant specifically withholds such consent.

(d) Continuation of Complaint Grievance. Neither the unwillingness of a complainant grievant to continue his or her complaint grievance, nor withdrawal of the complaint grievance, nor compromise between the complainant grievant and the lawyer, nor restitution by the lawyer, shall in itself require dismissal of a complaint grievance.

### TITLE 3

## SUSPENSION BEFORE FINAL DISPOSITION

### RULE 3.1

## SUSPENSION FOR CONVICTION OF A CRIME

(a) Court Clerk To Advise Association of Conviction. The clerk of any court of this state in which a lawyer is convicted of a crime shall advise the Association of the conviction, and shall provide the Association upon request with certified copies of any order or other document evidencing the conviction.

(b) Conviction Defined. "Conviction" for the purposes of this rule shall be considered to have occurred upon entry of a plea of guilty, unless the defendant affirmatively shows that the plea was not accepted or was withdrawn, or upon entry of a finding or verdict of guilty, unless the defendant affirmatively shows that judgment was arrested or a new trial granted.

(c) Determination of "Serious Crime." Upon being advised that a lawyer has been convicted of a crime, a review committee shall determine whether the crime constitutes a serious crime as defined by this rule, unless the crime is a felony. If the crime is a felony, or if a review committee determines by order that the crime constitutes a serious crime, state-bar disciplinary counsel shall petition the Supreme Court for an order suspending the lawyer during the pendency of disciplinary proceedings, and shall also proceed to file a formal complaint with regard to the conviction. The petition for suspension may be filed before the formal complaint. If the crime is not a felony and is determined not to be a serious crime, the review committee shall consider the report of the conviction in the same manner as any other report of possible misconduct by a lawyer.

(d) Petition. A petition to the Supreme Court for suspension of a lawyer under this rule shall include a copy of any available document establishing the fact of conviction. When the crime is not a felony, the petition shall also include a copy of the order of the review committee finding that the crime is a serious crime. The petition may also include additional facts, statements, arguments, affidavits, and documents in the discretion of state-bar disciplinary counsel. A copy of the petition shall be personally served upon the respondent lawyer, and proof of service filed with the court.

(e) Immediate Interim Suspension. Upon the filing of a petition for suspension pursuant to this rule, the court shall determine whether the crime constitutes a serious crime as defined herein.

If the crime is a felony, the court shall enter an order immediately suspending the lawyer from the practice of law. If the crime is not a felony, a show cause proceeding shall be conducted as provided in rule 3.2 (d)-(e) to determine whether the crime is a serious crime as defined herein. Suspension under this rule shall occur whether the conviction of the serious crime was under a law of this state or of any other state or was under federal law, and whether the conviction was after a plea of guilty, nolo contendere, not guilty, or otherwise, and regardless of the pendency of an appeal. Upon such suspension the lawyer shall comply with the notice provisions of rule 8.1(a). If the court determines that the crime is not a serious crime, the Association shall be advised and the matter shall be processed in the ordinary manner.

(f) Duration of Suspension. When a lawyer is suspended under this rule, the duration of such suspension shall not exceed final disposition of the disciplinary proceeding commenced against the lawyer. When the disciplinary proceeding is fully completed, after appeal or otherwise, the suspension occurring under this rule shall end.

(g) Termination of Suspension. The Board may, upon petition of the respondent lawyer, recommend to the Supreme Court the termination of a suspension under this rule at any time prior to the final disposition of the disciplinary proceedings. State-bar Disciplinary counsel may file a response to the petition for termination of suspension and may be directed by the chairperson of the Board to conduct such investigation as appears appropriate. Oral argument before the Board on the petition shall be permitted upon the request of either the respondent lawyer or state-bar disciplinary counsel and shall be conducted at such time and place and under such terms as the chairperson of the Board shall direct. A recommendation for termination of suspension may be made only upon an affirmative finding of the Board that there is good cause for terminating the suspension. Upon receipt by the court of a recommendation for termination of suspension, it shall be reviewed under such proceedings as the court may direct. There shall be no right of appeal from a decision of the Board declining to recommend termination of a suspension under this rule.

(h) Notice of Dismissal to Supreme Court. When a petition for suspension has been filed under this rule, and the disciplinary proceedings based on the criminal conviction of the lawyer are dismissed, the Supreme Court shall be provided with a copy of the decision granting dismissal whether or not the lawyer is under suspension at the time of dismissal.

(i) Definition of "Serious Crime." "Serious crime" includes any felony and also includes any other crime a necessary element of which, as determined by the statutory or common law definition of such crime, involves interference with the administration of justice, false swearing, misrepresentation, fraud, deceit, bribery, extortion, misappropriation or theft; or an attempt, or a conspiracy, or solicitation of another, to commit a "serious crime".



RULE 3.2  
SUSPENSION IN OTHER CIRCUMSTANCES

(a) Upon Finding of Risk to Public. At any time when it appears that a continuation of the practice of law by a respondent lawyer during the pendency of any proceeding under these rules, including proceedings under Title 10, will result in substantial harm, loss or damage to the public, the Association, on unanimous recommendation of a review committee, may petition the Supreme Court for an order suspending the respondent lawyer during the pendency of the proceedings.

(b) Upon Board Recommendation for Disbarment. When the Board enters a decision providing for disbarment of a lawyer, state-bar disciplinary counsel shall file a petition under this rule for suspension of the lawyer during the remainder of the proceedings. Suspension under this section shall occur unless a lawyer makes an affirmative showing that his or her continuation of the practice of law will not be detrimental to the integrity and standing of the Bar and the administration of justice, or be contrary to the public interest. If the decision of the Board is not appealed and becomes final, such petition need not be filed, or if filed may be withdrawn.

(c) Petition. A petition to the Supreme Court under this rule shall set forth the acts of the respondent lawyer believed to constitute grounds for such suspension, and if filed pursuant to section (b) shall include a copy of the decision of the Board. The petition may be supported by documents or affidavits. A copy of the petition shall be personally served upon the respondent lawyer.

(d) Show Cause Order. Upon filing of the petition an order to show cause, signed by the Chief Justice of the Supreme Court, shall be issued requiring the respondent lawyer to appear before the court on such date as the Chief Justice may set, and then and there show cause why the petition for suspension should not be granted. A copy of the order to show cause shall be personally served upon the respondent lawyer by the Association at least 5 days before the scheduled show cause hearing.

(e) Answer to Petition. The respondent lawyer may answer the petition. Any such answer may be supported by documents or affidavits. Failure to answer shall not result in default or waive the right to appear at the show cause hearing.

(f) Filing of Answer. A copy of any answer shall be filed with both the Supreme Court and the Association at least 3 days before the scheduled show cause hearing.

(g) Application of Other Rules. If the Supreme Court enters an order suspending the lawyer, the provisions of these rules relating to suspended attorneys, including Title 8, shall apply.

TITLE 4  
HEARING PROCEDURES AND STIPULATIONS

RULE 4.1  
APPLICATION OF CIVIL RULES

(a) General Conformance With Civil Rules. Proceedings pursuant to these rules shall be conducted in general conformance with the civil rules applicable to actions in the superior courts of the State of Washington. Those

rules shall apply directly when indicated, and in all other cases shall serve as guidance.

(b) Meaning of Terms. In applying the civil rules to proceedings pursuant to these rules, terms shall have the following meanings:

(1) "Court" or "judge" as used in the civil rules shall mean the hearing officer or panel chairperson; the hearing panel; or the Board or Board chairperson, as appropriate;

(2) "Parties" as used in the civil rules shall mean the respondent lawyer and state-bar disciplinary counsel.

RULE 4.2  
APPOINTMENT OF HEARING OFFICER OR  
PANEL

(a) Appointment. The chairperson of the Board shall appoint a hearing officer or panel to hear a matter ordered to hearing from among the persons eligible under rule 2.5, except that a member of the review committee which ordered the matter to hearing shall not be appointed on the case. When a panel is appointed the committee shall designate one lawyer member as chairperson. Any vacancy in the position of hearing officer or hearing panel member or chairperson may be filled by the chairperson of the Board.

(b) Disqualification. The respondent attorney may seek the disqualification of the hearing officer or any hearing panel member for cause.

(1) A request for disqualification of a hearing officer or panel member shall be filed in writing within 20 days of service upon the respondent lawyer of the name of the officer or panel member challenged. The request shall set forth in detail the reason for the request.

(2) The unchallenged member or members of the hearing panel, if any, shall rule on the request. In the event the challenge is against a hearing officer or against all members of the panel, or if the remaining members of the panel cannot agree, the chairperson of the Board shall rule on the requested disqualification.

(3) If a request for disqualification is granted, the chairperson of the Board shall fill the vacancy created. The respondent lawyer shall have the right to request the disqualification of any such appointee in the same manner as the original appointee.

(c) Authority. In addition to the powers specifically provided herein, the hearing officer or panel chairperson appointed to hear a matter may make any ruling which appears necessary and appropriate to insure a fair and orderly proceeding.

RULE 4.3  
COMMENCEMENT OF PROCEEDINGS

(a) Formal Complaint. Following a decision that a hearing should be held to determine whether a lawyer has committed an act of misconduct under rule 1.1, state bar disciplinary counsel shall prepare a formal complaint and file it in the office of the Association. State-bar Disciplinary counsel shall additionally send a copy of the formal complaint to the hearing officer or to each member of the hearing panel appointed to hear the matter, upon filing of the formal complaint or as soon thereafter as a hearing officer or panel is appointed.

(b) Content. The formal complaint shall set forth the acts or omissions of the respondent lawyer in sufficient detail to make the lawyer aware of the nature of the allegations of misconduct. It shall be signed by ~~state bar~~ disciplinary counsel, but need not be verified.

(c) Prior Discipline. The record of prior disciplinary proceedings resulting in the imposition of sanctions against the respondent lawyer may be made a separate count of the formal complaint if the lawyer is being charged with conduct demonstrating unfitness to practice law.

(d) Joinder. The body ordering a hearing on alleged misconduct may in its discretion consolidate for hearing two or more charges as to the same lawyer, or may join the charges as to two or more lawyers in one formal complaint.

(e) Filing Commences Proceedings. A disciplinary proceeding shall be deemed commenced when the formal complaint is filed.

(f) Service. After the formal complaint is filed it shall be personally served on the respondent lawyer, together with a notice to answer.

**RULE 4.4  
NOTICE TO ANSWER**

(a) Content. The notice to answer shall be substantially in the following form:

**BEFORE THE DISCIPLINARY BOARD  
OF THE WASHINGTON STATE BAR  
ASSOCIATION**

In re	}	NOTICE TO ANSWER AND NOTICE OF HEARING OFFICER [OR PANEL].
_____, an Attorney at Law.		NOTICE OF DEFAULT PROCEDURE

To: The above named attorney at law:

You are notified that a formal complaint has been filed against you, a copy of which is served upon you with this notice. You are notified that you must file your answer to the complaint within 20 days of the date of service upon you, filing the original and one copy of your answer at the office of the Washington State Bar Association, at the address given below, and by filing one copy [with the hearing officer] [with each member of the hearing panel] at the address[es] given below. Failure to file an answer may result in the imposition of a disciplinary sanction against you and the entry of an order of default pursuant to rule 4.10A of the Rules for Lawyer Discipline. Upon the filing of your answer, or in the case of your failure to answer within 20 days, further proceedings will be had in accordance with the Rules for Lawyer Discipline, and shall become public pursuant to rule 11.1.

**NOTICE OF DEFAULT PROCEDURE: YOUR DEFAULT MAY BE ENTERED FOR FAILURE TO FILE A WRITTEN ANSWER TO THIS FORMAL COMPLAINT WITHIN 20 DAYS AFTER SERVICE AS PRESCRIBED BY RULE 4.10A OF THE RULES FOR LAWYER DISCIPLINE. THE ENTRY OF AN ORDER OF DEFAULT MAY RESULT IN THE CHARGES OF MISCONDUCT SET FORTH IN THE FORMAL COMPLAINT BEING ADMITTED AND DISCIPLINE BEING IMPOSED OR RECOMMENDED BASED ON THE ADMITTED CHARGES OF**

MISCONDUCT. IF AN ORDER OF DEFAULT IS ENTERED, YOU WILL LOSE THE OPPORTUNITY TO PARTICIPATE FURTHER IN THESE PROCEEDINGS UNLESS AND UNTIL THE ORDER OF DEFAULT IS VACATED ON MOTION TIME-LY MADE UNDER RULE 4.10A(c) OF THE RULES FOR LAWYER DISCIPLINE. THE ENTRY OF AN ORDER OF DEFAULT MEANS THAT YOU WILL RECEIVE NO FURTHER NOTICES REGARDING THESE PROCEEDINGS EXCEPT THOSE RE-QUIRED BY RULE 4.10A (b)(2).

You are further notified that the [hearing officer] [hearing panel] assigned to this proceeding is: [insert name, address and telephone number of hearing officer, or name, address and telephone number of each hearing panel member with an indication of the chairperson of the panel].

Dated this \_\_\_\_ day of \_\_\_\_\_, 19\_\_.

WASHINGTON STATE BAR ASSOCIATION

By \_\_\_\_\_  
State Bar Counsel  
Disciplinary Counsel  
Bar #  
Address: \_\_\_\_\_  
\_\_\_\_\_  
Telephone: \_\_\_\_\_

(b) Notice When Hearing Officer or Panel Not Appointed. When at the time a formal complaint is filed no hearing officer or panel has been appointed to conduct the proceeding, the formal complaint and a notice to answer in the form prescribed in section (a), but omitting reference to the hearing officer or panel, shall be served on the respondent lawyer. In such case ~~state bar~~ disciplinary counsel shall serve upon the lawyer a separate notice of hearing officer or panel promptly upon appointment of a hearing officer or panel, and no action shall be taken by ~~state bar~~ disciplinary counsel in the proceeding except action permitted under Title 3 until such notice is given.

**RULE 4.5  
ANSWER**

(a) Content. A respondent lawyer must file and serve an answer containing:

(1) A specific denial of each fact or claim asserted in the formal complaint in accordance with the provisions of CR 8(b);

(2) A statement of any matter or facts constituting a defense, affirmative defense or justification, in ordinary and concise language without repetition; and

(3) An address at which all further pleadings, notices and other documents in relation to the proceeding may be served upon the respondent lawyer.

(b) Filing and Service. The answer shall be filed and served pursuant to rules 12.1 and 12.2. When a hearing panel has been appointed to hear a matter each member shall be sent a copy of the answer.

(c) Time To Answer. The respondent lawyer shall have 20 days from the date of service of the formal complaint and notice to answer to file his or her answer. Failure to file an answer as required may constitute grounds for discipline and for taking of an order of default according to the procedures set out in rule 4.10A.

**RULE 4.6**  
**AMENDMENT OF FORMAL COMPLAINT**

(a) **Right To Amend.** ~~State bar~~ Disciplinary counsel shall have the right to amend a formal complaint at any time to set forth additional facts or to add new charges, where the additional facts or new charges relate to the matters set forth in the complaint grievance to be amended or to the conduct of the lawyer with respect to the pending proceedings. A review committee need not authorize such amendment.

(b) **Amendment With Authorization.** A review committee may authorize an amendment of a formal complaint to add additional facts or new charges in other cases, or may require that the additional facts or charges be made the subject of a separate formal complaint. The chairperson of the Board, with the consent of the respondent lawyer, and after consultation with the hearing officer or panel chairperson on the previously filed matter, may consolidate hearing on such a separate formal complaint with hearing on the other pending formal complaint against the lawyer.

(c) **Service and Answer.** Service of an amendment to a formal complaint shall be made on the respondent lawyer as provided in rule 12.1(a). The respondent lawyer must file an answer to the amendment within 20 days of service, unless the time to answer is shortened upon motion of ~~state bar~~ disciplinary counsel. The answer to an amendment shall be governed by rule 4.5, except that any part of a previous answer may be incorporated therein by reference. Failure to file an answer to an amendment may constitute grounds for discipline and for taking an order of default according to the procedures set out in rule 4.10A.

**RULE 4.7**  
**DISCOVERY**

(a) **Depositions.** The taking of depositions pursuant to either CR 30 or 31 is permitted after the filing of a formal complaint under the following circumstances:

(1) Either ~~state bar~~ disciplinary counsel or the respondent lawyer may take the deposition of a witness living outside the state or county in which the hearing is to be held or who is physically unable to attend the hearing.

(2) The hearing officer or panel chairperson shall have the power to authorize the taking of any other deposition, and to make such further orders relative thereto as will insure a fair and orderly hearing.

(3) Where depositions are to be taken outside of the state of Washington, a commission need not issue, but a copy of the order of the hearing officer or panel chairperson, certified by the officer or chairperson, shall be sufficient authority to authorize the taking of such depositions.

(4) Subpoenas for depositions may be issued pursuant to the provisions of CR 45.

(5) All depositions when taken and transcribed shall be filed in the office of the Association.

(b) **Requests for Admission.** After the filing of a formal complaint, the respondent lawyer and the Association may use requests for admission as set forth in CR 36. Under appropriate circumstances, in the exercise of

his or her discretion, the hearing officer or panel chairperson may apply the sanctions set forth in CR 37(c) for improper denial of requests for admission.

(c) **Other Discovery.** After the filing of a formal complaint, the respondent lawyer and ~~state bar~~ disciplinary counsel shall have the rights given to superior court civil litigants under CR 33, 34, and 35 only upon application and under such terms, and with such limitations, as the hearing officer or panel chairperson deems just.

(d) **Limitations.** In the exercise of his or her discretion, the hearing officer or panel chairperson shall impose such terms or limitations on the exercise of discovery as may appear necessary to prevent undue delay or expense in bringing the matter to hearing and to promote the interests of justice.

(e) **Duty To Cooperate.** It shall be the duty of the lawyer who has been served with a formal complaint to respond to discovery requests and to all lawful orders made by the hearing officer or panel chairperson pursuant to this rule. Failure to so respond may constitute grounds for discipline, and the hearing officer or panel may additionally draw such adverse inferences as appear warranted by the lawyer's failure to respond.

**RULE 4.8**  
**MOTIONS**

(a) **Filing and Service.** Motions made by any party to the hearing officer or panel chairperson, except motions which may be made ex parte or motions made at hearing, shall be in writing and shall be filed and served as required by rules 12.1 and 12.2.

(b) **Response.** The opposing party shall be allowed 5 days from service of a motion on him or her to respond, unless the time is shortened by the hearing officer or panel chairperson for good cause. A request to shorten time for response to a motion may be made ex parte.

(c) **Consideration of Motion.** Upon expiration of the time for response, the hearing officer or panel chairperson shall promptly rule on the motion, with or without argument as may appear appropriate. Argument on a motion may be heard by conference telephone call.

(d) **Ruling.** A ruling on a written motion shall be in writing and filed with the Association.

(e) **Minor Matters.** Alternatively, motions on minor matters may be made in letter form to the hearing officer or panel chairperson, with a copy to the opposing party and to the Association for inclusion in the bar file. The provisions of sections (b) and (c) shall apply to such matters. A ruling on such motion may also be in letter form, directed to each party and with a copy to the Association for inclusion in the bar file.

**RULE 4.9**  
**PROCEEDING BASED ON CRIMINAL  
CONVICTION**

When a formal complaint charges a lawyer with an act of misconduct for which the lawyer has been convicted in a criminal proceeding, the court record setting forth the conviction shall be conclusive evidence at the

ensuing disciplinary hearing of the guilt of the respondent lawyer of the crime for which he or she was convicted and of his or her violation of the statute upon which the conviction was based.

#### RULE 4.10 DISCIPLINARY HEARING

(a) Where Held. All disciplinary hearings shall be held in the state of Washington at a location designated by the hearing officer or panel chairperson, except that if the respondent lawyer is not a resident of the state, or cannot be found in the state, the hearing may be held outside of the state.

(b) Scheduling of Hearing. When possible, ~~state-bar disciplinary~~ counsel and the respondent lawyer should arrange a date, time, and place for the hearing by agreement among themselves and the hearing officer or panel members. Alternatively, at any time after the respondent lawyer has filed his or her answer to the formal complaint, or after the time to file such an answer has expired, either ~~state-bar disciplinary~~ counsel or the respondent lawyer may move the hearing officer or hearing panel chairperson for an order setting a date, time, and place for the hearing. Such a motion shall be made pursuant to rule 4.8 and shall set forth the requested date or dates for the hearing, other dates that are available to the requesting party, the expected length of time the hearing will take, the nature of matters including discovery which are pending or which must be completed prior to the hearing, and the requested time and place for the hearing. A response to such a motion shall contain the same information. The hearing officer or panel chairperson shall rule on the motion as provided in rule 4.8(c) and file a ruling as provided in rule 4.8(d).

(c) Motion for Hearing Within 120 Days. A request by a respondent lawyer, made by motion pursuant to section (b), for a hearing within 120 days shall be granted, unless ~~state-bar disciplinary~~ counsel shows good cause for setting the hearing at a later date.

(d) Notice. Service of a copy of an order or ruling of the hearing officer or panel chairperson setting a date, time, and place for the hearing shall constitute notice of the hearing. The respondent lawyer shall be given at least 10 days' notice of the hearing unless he or she otherwise consents.

(e) Continuance. Either the respondent lawyer or ~~state-bar disciplinary~~ counsel may by motion request a continuance of the hearing date. Such a motion may be granted in the discretion of the hearing officer or panel chairperson for good cause shown.

(f) Representation. The Association shall be represented at the hearing by ~~state-bar disciplinary~~ counsel. The respondent lawyer may be represented by counsel.

(g) Lawyer Must Attend. A respondent lawyer given notice of a hearing must attend the hearing.

(1) The lawyer must bring to the hearing such documents, files, records, or other written materials or things as ~~state-bar disciplinary~~ counsel may request in writing. The written request shall be served on the respondent lawyer at least 3 days before the scheduled hearing.

Failure to attend the hearing or bring requested materials as herein provided, without good cause, may constitute grounds for discipline.

(2) If the respondent lawyer fails to attend the hearing, after proper notice, the hearing officer or panel may draw an adverse inference from the respondent's failure to attend as to any questions which might have been asked the lawyer at the hearing. The hearing officer or panel shall allow evidence and testimony to be submitted through depositions regardless of the availability of the person testifying at the deposition. Affidavits or declarations are also admissible, if the facts stated in the affidavits are within the personal knowledge of the affiant, if the facts are set forth with particularity and if the affidavit to be offered in evidence shows affirmatively that the affiant if sworn as a witness could testify competently to the facts set forth in the affidavit.

(h) Default. A default may be taken against a respondent lawyer according to the procedures set out in rule 4.10A.

(i) Witnesses. Except as provided in section (g)(2) and rule 4.10A, witnesses shall testify under oath. Testimony may also be submitted by deposition under the same terms as permitted by CR 32. Testimony shall be recorded by a court reporter or by tape recording if allowed by the hearing officer or panel chairperson.

(j) Subpoenas. Subpoenas for witnesses or for production of documents or things shall be available to both the respondent lawyer and ~~state-bar disciplinary~~ counsel pursuant to the terms of CR 45.

#### RULE 4.10A DEFAULT PROCEEDINGS

(a) Entry of Default.

(1) Motion. When a respondent lawyer, after being served with a notice to answer as provided in rule 4.4, fails to file the answer required by rule 4.5 within the time provided by these rules, ~~state-bar disciplinary~~ counsel shall serve written notice of a motion for an order of default upon the respondent lawyer.

(2) Notice. The respondent lawyer shall be served with a written notice of motion for an order of default at least 20 days before the date of entry of the order of default. The notice of a motion for an order of default shall include the following:

(i) The date of filing of the notice to answer and formal complaint and the date of service.

(ii) That the respondent attorney has not timely filed an answer as required by rule 4.5.

(iii) That ~~state-bar disciplinary~~ counsel intends to seek an order of default.

(iv) The following notice substantially in the following form:

YOUR DEFAULT WILL BE ENTERED IF NO ANSWER IS FILED WITH THE BAR ASSOCIATION WITHIN 20 DAYS OF SERVICE OF THIS NOTICE OF A MOTION FOR AN ORDER OF DEFAULT. ENTRY OF AN ORDER OF DEFAULT WILL RESULT IN THE ALLEGATIONS SET FORTH IN THE FORMAL COMPLAINT(S) BEING ADMITTED AND DISCIPLINE RECOMMENDED OR IMPOSED BASED ON THOSE ADMITTED ALLEGATIONS. IF THE ORDER OF DEFAULT IS ENTERED, YOU WILL LOSE THE OPPORTUNITY TO PARTICIPATE FURTHER IN THESE PROCEEDINGS UNLESS AND

UNTIL THE ORDER OF DEFAULT IS VACATED ON A TIMELY MOTION SETTING FORTH THE PROPER GROUNDS. SEE SECTION (c). THE ENTRY OF AN ORDER OF DEFAULT MEANS THAT YOU WILL RECEIVE NO FURTHER NOTICES REGARDING THESE PROCEEDINGS EXCEPT THOSE REQUIRED BY SECTION (b)(2).

(3) Service. Service of the motion for an order of default shall be as provided in rule 12.1.

(4) Entry of Order of Default. If the respondent lawyer fails to file a written answer with the Bar Association within 20 days after service of the notice of the motion for entry of an order of default, the hearing officer or panel, shall, upon proof of proper service of the notice of motion for an order of default, enter an order finding the respondent lawyer in default. The order of default shall contain notice substantially in the following form:

AN ORDER OF DEFAULT HAS BEEN ENTERED AGAINST YOU BECAUSE OF YOUR FAILURE TO TIMELY FILE AN ANSWER TO THE FORMAL COMPLAINT(S) FILED IN THIS PROCEEDING. THE ALLEGATIONS SET FORTH IN THE FORMAL COMPLAINT(S) HAVE BEEN DEEMED ADMITTED AND DISCIPLINE MAY BE IMPOSED UPON YOU BASED ON THOSE ADMITTED ALLEGATIONS. YOU MAY NOT PARTICIPATE FURTHER IN THESE DISCIPLINARY PROCEEDINGS UNLESS AND UNTIL THE ORDER OF DEFAULT IS VACATED ON A TIMELY MOTION SETTING FORTH THE PROPER GROUNDS. THIS ORDER OF DEFAULT MEANS THAT YOU WILL RECEIVE NO FURTHER NOTICES REGARDING THESE PROCEEDINGS EXCEPT THOSE REQUIRED BY SECTION (b)(2).

(b) Proceedings After Entry of an Order of Default.

(1) Service of the order of default shall be as provided in rule 12.1.

(2) After entry of an order of default no further notices shall be served upon the respondent lawyer except for copies of the decisions of the hearing panel and the Disciplinary Board.

(3) A formal disciplinary hearing shall occur no later than 60 days after filing of the order of default. The hearing panel officer shall be entitled to rely upon properly served requests for admission served upon the respondent pursuant to rule 4.7(b). Depositions may be used as evidence regardless of the availability of the person testifying at the deposition. Affidavits or declarations are also admissible, if the facts stated in the affidavits are within the personal knowledge of the affiant, if the facts are set forth with particularity and if the affidavit to be offered in evidence shows affirmatively that the affiant if sworn as a witness could testify competently to the facts set forth in the affidavit.

(c) Setting Aside Default.

(1) Motion To Vacate Order of Default. A respondent lawyer may file a motion to vacate the order of default and any decision of the hearing officer or panel or Disciplinary Board arising from the default on the following grounds:

(i) Mistakes, inadvertence, surprise, excusable neglect or irregularity in obtaining the default;

(ii) For erroneous proceedings against a respondent who was, at the time of the default, incapable of conducting a defense;

(iii) Newly discovered evidence which by due diligence could not have been previously discovered;

(iv) Fraud, misrepresentation or other misconduct of an adverse party;

(v) The order of default is void;

(vi) Unavoidable casualty or misfortune preventing the respondent from defending;

(vii) Any other reason justifying relief from the operation of the default.

(2) Time. The motion shall be made within a reasonable time and for reasons (i) and (iii) not more than 1 year after the default was entered. If the respondent's motion is based upon allegations of incapability of conducting a defense, the motion shall be made within 1 year after the disability ceases.

(3) Burden of Proof. The burden of proving the grounds for setting aside the default shall be upon the respondent. If the respondent proves that the default was entered as a result of a disability which made the respondent incapable of conducting a defense, the default shall be set aside.

(4) Service and Contents of Motion. The motion shall be filed and served as provided in rules 12.1 and 12.2. The motion shall be accompanied by a copy of respondent's proposed answer to the formal complaint(s) as to which an order of default has been entered. The proposed answer shall set forth with specificity the respondent's asserted defenses and any facts that respondent asserts as mitigation. The motion to vacate the order of default shall be supported by an affidavit showing (i) the date on which the respondent first learned of the entry of the order of default; (ii) the reasons or grounds for setting aside the order of default; and (iii) an offer of proof of the facts which the respondent expects to show if the order of default is vacated.

(5) Response to Motion. Within 10 days after filing and service of the motion to vacate, ~~state bar~~ disciplinary counsel may file and serve a written response to the motion.

(6) Decision. The motion to vacate the order of default shall be decided by the hearing officer or panel. In the event that the proceedings have been concluded, the chairperson of the Disciplinary Board shall appoint a hearing officer or panel to decide the motion for default. The motion shall be decided on the written record without oral argument. Pending a ruling on the motion the hearing officer or panel may order a stay of proceedings not to exceed 30 days. In granting a motion to vacate an order of default, the hearing officer or panel has discretion to order such conditions as appear proper.

(7) Appeal of Denial of Motion. A decision by the hearing officer or panel denying a motion for an order vacating an order of default may be appealed to the chairperson of the Disciplinary Board if the respondent lawyer files and serves a written notice of appeal which sets forth the arguments against the hearing officer or panel's decision. The notice of appeal must be filed within 10 days of service of the order denying the motion upon the respondent. The appeal shall be decided on the written record without oral argument. Pending a ruling on the appeal the chairperson may order a stay of proceedings not to exceed 30 days. In granting a motion for order vacating an order of default, the chairperson has discretion to order such conditions as appear proper.

(8) Decision To Vacate Is Final. There shall be no appeal from an order setting aside an order of default.

(d) Order of Default Not Authorized in Certain Proceedings. The default proceedings outlined in this rule shall not be used in any proceeding to inquire into a lawyer's competency under Title 10 of the Rules for Lawyer Discipline.

#### RULE 4.11 EVIDENCE AND BURDEN OF PROOF

(a) Proceedings Not Civil or Criminal. In resolving evidentiary and other procedural questions the hearing officer or panel chairperson should make rulings based upon the legal principle that disciplinary proceedings are neither civil nor criminal but are sui generis hearings intended to determine whether a lawyer's conduct should have an impact upon his or her license to practice law.

(b) Burden of Proof. ~~State-bar~~ Disciplinary counsel shall have the burden of establishing an act of misconduct by a clear preponderance of the evidence.

(c) Rules of Evidence. Consistent with sections (a) and (b) of this rule the following rules of evidence shall apply during disciplinary hearings:

(1) The hearing officer or panel may admit and give probative effect to evidence which possesses probative value commonly accepted by reasonably prudent persons in the conduct of their affairs. The hearing officer or panel may exclude incompetent, irrelevant, immaterial, and unduly repetitious evidence.

(2) All evidence, including but not limited to records and documents in the possession of the Association of which it desires to avail itself, shall be offered and made a part of the record in the case and no other factual information or evidence shall be considered in the determination of the case. Documentary evidence may be received in the form of copies or excerpts or by incorporation by reference.

(3) The respondent and ~~state-bar~~ disciplinary counsel shall have the right of cross examination of witnesses who testify and shall have the right to submit rebuttal evidence.

(4) The hearing officer or panel may take notice of judicially cognizable facts and in addition may take notice of general, technical, or scientific facts within the hearing officer's or panel's specialized knowledge. The respondent and ~~state-bar~~ disciplinary counsel shall be notified either before or during hearing, or by reference in preliminary reports or otherwise, of the material so noticed and shall be afforded an opportunity to contest the facts so noticed.

#### RULE 4.12 PRIOR DISCIPLINARY RECORD

(a) Required Part of Record of Proceedings. If a lawyer has a record of prior discipline, the nature of that record, or the fact that the lawyer has had no prior discipline, must be made a part of the hearing record before the decision of the hearing officer or panel is filed.

(b) Bifurcated Proceedings. Upon written motion filed no later than 20 days prior to the scheduled hearing, either the respondent lawyer or ~~state-bar~~ disciplinary counsel may request that the disciplinary proceeding be

bifurcated. The motion shall be granted when bifurcation appears necessary to insure a fair and orderly proceeding.

(1) A bifurcated proceeding shall begin with an initial factfinding hearing. During this stage of the proceedings evidence of a prior disciplinary record shall not be admissible to prove the character of the respondent lawyer or to impeach his or her credibility. Evidence of prior acts of misconduct may, however, be admissible for other purposes, such as proof of motive, opportunity, intent, preparation, plan, knowledge, identity, or absence of mistake, or accident. At the conclusion of that hearing, the hearing officer or panel shall file findings and conclusions. If no misconduct is found, the proceedings are concluded and the findings and conclusions shall be the decision of the hearing officer or panel.

(2) After the filing of the findings and conclusions, if misconduct is found, a second proceeding shall be held to determine the appropriate recommendation. During the second proceeding evidence of the existence or lack of any prior disciplinary record shall be admissible. At the conclusion of the second proceeding, the hearing officer or panel shall file its recommendation. The recommendation together with the previously filed findings and conclusions shall be the decision of the hearing officer or panel.

#### RULE 4.13 DECISION OF HEARING OFFICER OR PANEL

(a) Proposed Findings. At the request of the hearing officer or panel chairperson, or without such request, either the respondent lawyer or ~~state-bar~~ disciplinary counsel may submit a proposed decision in the form of findings, conclusions, and recommendation to the hearing officer or to each member of the hearing panel.

(b) Filing. Within 20 days after the proceedings are concluded, unless extended by agreement, the hearing officer or panel chairperson should file a decision in the form of findings, conclusions, and recommendation in the office of the Association.

(c) Amendment. Within 5 days of service of the decision of the hearing officer or panel on the respondent lawyer, either the respondent lawyer or ~~state-bar~~ disciplinary counsel may file a motion to modify, amend, or correct the decision. When a hearing panel member dissents from a decision of the majority, the 5-day period shall not begin until the written dissent is filed or the period to file such a dissent has expired, whichever is sooner. Consideration of such a motion shall be governed by the provisions of rule 4.8, except that all members of a hearing panel shall be served with the motion and any response thereto, and shall participate in a decision on the motion. Deliberation by a panel may be conducted through telephone conference call. The hearing officer or panel shall rule on such a motion within 15 days after the filing of a timely response or after the period to file such a response under rule 4.8(b) has expired. The ruling may deny the motion or may allow such amendment, modification, or correction of the decision as may appear appropriate. Failure to move for a modification, correction, or amendment shall not affect any appeal to the Board or review by the Supreme Court.

(d) Dissent of Panel Member. Any member of a hearing panel who dissents from the decision of the majority of the panel shall file a dissent, which may consist of alternative findings, conclusions, or recommendation. A dissent should be filed within 10 days of the filing of the decision of the majority of the panel and shall become part of the record of the proceedings.

(e) Panel Members Unable To Agree. Where no two panel members are able to agree on a decision, each panel member shall file his or her own findings, conclusions, and recommendation, and the Board shall review the matter whether or not an appeal is filed.

(f) Decision Final. When the decision of a hearing officer or panel recommends reprimand or censure upon a finding of misconduct, or recommends dismissal of the charges against the respondent lawyer, the recommendation shall become the final decision in the case if neither the respondent lawyer nor ~~state-bar~~ disciplinary counsel files an appeal within the time permitted by rule 6.1.

#### RULE 4.14 STIPULATIONS

(a) Requirements. Any disciplinary matter or proceeding may be disposed of by a stipulation for discipline entered into at any time. The stipulation shall be signed by the respondent lawyer and approved by ~~state-bar~~ disciplinary counsel. The stipulation may contain the imposition of terms and conditions of probation and such other provisions as may appear appropriate.

(b) Form. A stipulation for discipline shall:

(1) Set forth the material facts relating to the particular acts or omissions of the respondent lawyer in such detail as to enable a review committee or the Board to form an opinion as to the propriety of the discipline being agreed upon, and, if approved, to make the stipulation useful in any subsequent disciplinary proceeding against the respondent lawyer;

(2) Set forth the respondent lawyer's prior disciplinary record or the absence of such record;

(3) State that the stipulation is not binding on the Association as a statement of all existing facts relating to the professional conduct of the respondent lawyer, but that any additional existing facts may be proven in any subsequent disciplinary proceeding; and

(4) Fix the amount of the costs and expenses to be paid by the lawyer.

(c) Approval. A stipulation providing for suspension or disbarment shall be filed with the Board. Any other stipulation shall be filed with a review committee. A stipulation may be presented to the Board or to a review committee without notice and shall be reviewed solely on the basis of the record as agreed upon by the respondent lawyer and ~~state-bar~~ disciplinary counsel. The Board or review committee may either approve a stipulation or reject it. Regardless of the provisions of rule 11.1(g), the Board or a review committee may direct that information or documents considered in reviewing a stipulation be kept confidential.

(d) Stipulation Not Approved. If a stipulation is not approved by a review committee or by the Board as herein provided, then the stipulation shall be of no force

and effect and neither it nor the fact of its execution shall be admissible in evidence in the pending disciplinary proceeding, in any subsequent disciplinary proceeding, or in any civil or criminal action.

(e) Failure To Comply. Failure of a respondent lawyer to comply with the terms of a stipulation for discipline entered into and approved as provided in this rule may constitute grounds for discipline.

### TITLE 5 SANCTIONS AND OTHER REMEDIES

#### RULE 5.1 SANCTIONS

Upon a finding that a lawyer has committed an act of misconduct, one or more of the following sanctions, or an admonition pursuant to rule 5.5A, may be imposed:

- (a) Disbarment;
- (b) Suspension from the practice of law for an appropriate fixed period of time not exceeding 2 years;
- (c) Reprimand;
- (d) Censure;
- (e) Cumulative disciplinary suspension pursuant to rule 5.4.

#### RULE 5.2 PROBATION

(a) Conditions of Probation. A lawyer who has been found to have committed an act of misconduct and who has been sanctioned pursuant to rule 5.1 may in addition be placed on probation for a fixed period not in excess of 2 years, under such conditions as may appear appropriate. Such conditions may include but are not limited to requiring alcohol or drug treatment, requiring medical care, requiring psychological or psychiatric care, requiring professional office practice or management counseling, and requiring periodic audits or reports. In any case where a lawyer is placed on probation pursuant to this rule, the chairperson of the Board may upon the request of ~~state-bar~~ disciplinary counsel appoint a suitable person to supervise the probation. Cooperation with a person so appointed shall be a condition of the probation.

(b) Failure To Comply. Failure to comply with a condition of probation may result in a disciplinary proceeding pursuant to rule 1.1(m), and any sanction to be imposed for violation of that provision shall take into account the act or acts of misconduct leading to the probation.

#### RULE 5.3 RESTITUTION

(a) Restitution May Be Required. A lawyer who has been found to have committed an act of misconduct and who has been sanctioned pursuant to rule 5.1 may in addition be ordered to make restitution to persons financially injured by the lawyer's conduct.

(b) Payment of Restitution. A lawyer ordered to make restitution shall do so within 30 days of the date upon which the decision requiring restitution becomes final, unless otherwise provided in that decision, or unless a periodic payment plan has been entered into with the approval of ~~state-bar~~ disciplinary counsel. ~~State-bar~~ Disciplinary counsel shall have authority to enter into an



agreement with a lawyer for a reasonable periodic payment plan upon the lawyer's affirmative written demonstration of present inability to meet the terms of a decision requiring restitution, and after consultation with the persons to whom restitution is to be made.

(c) Failure To Comply. Failure of a lawyer to make restitution when ordered to do so, or failure of a lawyer to comply with the terms of a periodic payment plan entered into by agreement between the lawyer and state bar disciplinary counsel, may constitute grounds for discipline.

#### RULE 5.4

##### SUSPENSION FOR CUMULATIVE DISCIPLINE

(a) Grounds. A lawyer may be suspended from the practice of law for a fixed period of time not exceeding 2 years upon accumulation of:

- (1) Three or more censures and/or reprimands;
- (2) Any combination of a suspension or disbarment plus one or more censures or reprimands.

(b) Procedure. Suspension for cumulative discipline may be recommended by a hearing officer or panel or by the Board during the course of any disciplinary proceeding when a recommended sanction in that proceeding results in an accumulation of discipline equal to or exceeding that provided in section (a). Alternatively, a review committee may authorize the filing of a formal complaint based solely on the provisions of this rule. The issues in such a proceeding, which shall be conducted in the same manner as any disciplinary proceeding, shall be whether the respondent lawyer has accumulated a record of discipline which would subject him or her to the provisions of this rule and, if so, whether a suspension for cumulative discipline should be recommended.

#### RULE 5.5

##### ADMINISTRATION OF CENSURE AND REPRIMAND

(a) Censure. A censure shall be administered to a respondent lawyer by letter. The letter shall be prepared by state bar disciplinary counsel and shall be signed by the president of the Association. If the respondent lawyer objects to the content of such letter, he or she may file a request for review of the content of the letter of censure with the Board. The Board shall review the letter of censure in light of the decision or stipulation imposing the censure and may take whatever action appears appropriate under the circumstances. The action of the Board shall be final and not subject to further review.

(b) Reprimand. A reprimand shall be administered personally to a respondent lawyer. The lawyer shall appear at a time and place directed by the Board of Governors to receive the reprimand. Notice shall be given at least 20 days before the scheduled appearance at which time a copy of the proposed reprimand shall be provided to the respondent lawyer. Within 5 days of receipt of the notice the lawyer may file a request for review of the content of the proposed reprimand with the Disciplinary Board. Such a request will stay the administration of the reprimand. The Disciplinary Board shall review the proposed reprimand in light of the decision or stipulation

imposing the reprimand and may take whatever action appears appropriate under the circumstances. The action of the Board shall be final and not subject to further review. If no such request is received, the reprimand shall be administered at the time and place set. It shall be given privately, and the respondent lawyer shall not make any statement in support of or in opposition there- to or in mitigation thereof. A reprimand shall be deemed administered at the time it is scheduled whether or not the lawyer appears as required. Failure to so appear after proper notice may constitute grounds for discipline.

#### RULE 5.5A

##### ADMNITION

(a) Grounds. An admonition may be issued by a review committee, or as permitted by rule 2.3 (f)(5), by the Disciplinary Board, when investigation of a complaint grievance shows misconduct involving inattention, neglect or lack of competence in handling a matter.

(b) Effect. An admonition shall be admissible in evidence in subsequent discipline or disability proceedings involving the lawyer. File materials relating to an investigation concluded with an admonition, including the admonition, shall be subject to destruction as provided in rule 12.8(b).

(c) Protest. A lawyer wishing to protest the issuance of an admonition must file a notice to that effect with the Association within 30 days of service of the admonition. Upon receipt of a timely protest, the admonition is rescinded, and the complaint grievance shall be considered to have been ordered to hearing by the review committee issuing the admonition.

(d) Action on Board Review. After a hearing on the protest relating to the issuance of the admonition, and upon appeal pursuant to rule 6.1(b), the Board may dismiss, issue an admonition, or impose sanctions pursuant to rule 5.1.

(e) Admonition Not Public. An admonition shall not be a public matter, unless a stipulation approved by a review committee or Disciplinary Board provides that the admonition shall be public, or the admonition is admitted into evidence in a public disciplinary proceeding, or issued by the Board after a hearing under section (d).

#### RULE 5.5B

##### DISCIPLINE FOR CUMULATIVE ADMONITIONS

(a) Grounds. A lawyer may be disciplined, and receive a sanction pursuant to rule 5.1, upon accumulation of three admonitions within a 5-year period.

(b) Procedure. Upon being presented with evidence that a lawyer has received three admonitions within a 5-year period following the effective date of this rule, a review committee may authorize the filing of a formal complaint based solely on the provisions of this rule. The issues in such a proceeding, which shall be conducted in the same manner as any disciplinary proceeding, shall be whether the respondent lawyer has accumulated a record of three admonitions within a 5-year period and, if so, what disciplinary sanction should be recommended.



**RULE 5.6  
ADVISORY LETTER**

An advisory letter may be issued when a hearing does not appear warranted but when it appears appropriate to caution a lawyer concerning his or her conduct. An advisory letter may be issued by a review committee, or by the Board when reviewing a matter under rule 2.3 (f)(5), but shall not be issued when a complaint grievance is dismissed following a hearing. An advisory letter shall not constitute a finding of misconduct and is not a disciplinary sanction.

**RULE 5.7  
COSTS AND EXPENSES**

(a) Assessment. In all cases in which a sanction or admonition is imposed upon a lawyer following a hearing and a finding of misconduct, or a lawyer accepts an admonition pursuant to rule 5.5A(a), costs and expenses as herein defined may be assessed against the lawyer in favor of the Association.

(b) Costs Defined. The term "costs" for the purposes of this rule shall include all obligations in money reasonably and necessarily incurred by the Association in the complete performance of its duties under these rules, whether incurred before or after the filing of a formal complaint, except attorney fees. Costs shall include, by way of illustration and not of limitation:

- (1) Charges of court reporters in attending and transcribing depositions or hearings;
- (2) Charges of process servers;
- (3) Necessary travel expenses of hearing officers or hearing panel members, or of state-bar disciplinary counsel, or of witnesses;
- (4) Charges of expert witnesses;
- (5) Costs in conducting an examination of books and records or an audit pursuant to Title 13;
- (6) Costs incurred in supervising probation imposed pursuant to rule 5.2;
- (7) Telephone toll charges;
- (8) Charges of a lawyer appointed pursuant to rule 10.2(d);
- (9) Costs of copying materials for submission to a review committee, a hearing officer or panel, the Disciplinary Board, or the Board of Governors.

(c) Expenses Defined. "Expenses" for the purposes of this rule shall mean a reasonable charge for attorney fees and administrative costs. Expenses assessed pursuant to this rule may equal the actual expenses incurred by the Association, but in any case the following amounts shall conclusively be presumed reasonable:

- (1) For an admonition that is accepted pursuant to rule 5.5A(a), \$500.
- (2) For a matter which becomes final without review by the Board, \$1,000.
- (3) For a matter which becomes final following Board review, without appeal to the Supreme Court, a total of \$1,500.
- (4) For a matter appealed to the Supreme Court, a total of \$2,000.
- (d) Association To File Statement of Costs and Expenses. When the decision of a hearing officer or panel

imposing a sanction becomes final without Board review, or when a decision of the Board imposing a sanction or an admonition becomes final after being served on the respondent lawyer after Board review, or when a decision of the Board imposing discipline is appealed, the Association shall have 10 days in which to file a statement of costs and expenses in the office of the Association.

(1) Content. A statement of costs and expenses shall state with particularity the nature and amount of the costs claimed and shall state the expenses requested. The statement shall be signed by state-bar disciplinary counsel, which signature shall constitute a certification that all reasonable attempts have been made to insure the accuracy of the statement.

(2) Exceptions. The respondent lawyer shall have 10 days from service of the statement of costs and expenses on him or her to file exceptions in the office of the Association.

(e) Assessment. The chairperson of the Board shall review the statement of costs and expenses and any exceptions thereto after the period for filing such exceptions has passed and the decision of the hearing officer or panel or of the Board and shall enter and file with the Association an order assessing costs and expenses. The order shall be served on the respondent lawyer.

(1) Request for Review by Board. Within 10 days of service on the respondent lawyer of the order assessing costs and expenses, the lawyer may file with the Association a request for Board review of the order. Upon the timely filing of such a request, the Board shall review the order assessing costs and expenses, based upon the statement of costs and expenses of the Association and the exceptions thereto, the decision of the hearing officer or panel or of the Board, and any written statement submitted by either party within such time as the chairperson of the Board may direct.

(2) Board Action. The Board may approve or modify the order assessing costs and expenses by order filed with the Association and served upon the respondent lawyer. The decision of the Board shall be final when filed and not subject to further review, except in cases reviewed by the Supreme Court pursuant to Title 7.

(f) Assessment in Matters Reviewed by the Supreme Court. When a matter is reviewed by the Supreme Court as provided in Title 7, any order assessing costs and expenses entered pursuant to section (e) and any statement of costs and expenses and exceptions thereto filed in the proceeding shall be made a part of the record transmitted to the court. Upon filing of an opinion by the court imposing a sanction, costs and expenses may be assessed in favor of the Association pursuant to the procedures of RAP Title 14, except that "costs" as used in that rule shall mean any costs and expenses allowable under this rule.

(g) Waiver. In all cases where costs and expenses are sought pursuant to this rule, assessment of any or all such costs and expenses may be denied where it appears in the interests of justice to do so.

(h) Payment of Costs and Expenses. A lawyer ordered to pay costs and expenses shall do so within 30 days of the date upon which the assessment becomes final, unless

otherwise ordered at the time costs and expenses are assessed, or unless a periodic payment plan has been entered into with the approval of ~~state bar~~ disciplinary counsel. ~~State bar~~ Disciplinary counsel shall have authority to enter into an agreement with a lawyer for a reasonable periodic payment plan upon the lawyer's affirmative written demonstration of present inability to meet the terms of an order or decision assessing costs and expenses.

(i) Failure To Comply. Failure of a lawyer to pay costs and expenses when ordered to do so or failure of a lawyer to comply with the terms of a periodic payment plan entered into by agreement between the lawyer and ~~state bar~~ disciplinary counsel may constitute grounds for discipline.

(j) Costs in Other Cases. Costs in cases involving stipulations shall be governed by the provisions of rule 4.14. Assessment of costs in cases of transfer to disability inactive status shall be governed by the provisions of this rule, but payment of such costs shall not become due until 90 days after the lawyer is reinstated to active status.

## TITLE 6 REVIEW BY BOARD

### RULE 6.1

#### DECISIONS SUBJECT TO BOARD REVIEW

The decision of a hearing officer or panel shall be reviewed by the Board when:

(a) The recommendation is for the suspension or disbarment of the respondent lawyer; or

(b) The respondent lawyer or ~~state bar~~ disciplinary counsel files a notice of appeal with the Association within 15 days of service of the decision on the respondent lawyer. When a motion to amend is filed as permitted by rule 4.13(c) the 15-day period shall not begin until the motion is decided. A notice of appeal shall specify the issues intended to be raised before the Board.

### RULE 6.2

#### REVIEW OF SUSPENSION OR DISBARMENT RECOMMENDATION

(a) Statements in Support or Opposition. When a matter is before the Board for review of a recommendation of suspension or disbarment, the respondent lawyer and ~~state bar~~ disciplinary counsel may each file a statement in support of or in opposition to the decision of the hearing officer or panel, or any part of that decision.

(b) Transcript Required. When a hearing officer or panel has entered a recommendation for suspension or disbarment, a transcript of the hearing shall be prepared, served and settled as provided in rule 6.6.

(c) Time for Filing Statements. Statements shall be filed with the Association according to the following schedule:

(1) The respondent lawyer shall file his or her statement (i) within 20 days of service on the lawyer of a copy of the transcript of the hearing, whether or not the transcript has been settled, or (ii) within 20 days of the service on the lawyer of the decision of the hearing officer or panel when the transcript has previously been

prepared and served on the respondent lawyer, whichever occurs later. When a motion to amend has been filed as permitted by rule 4.13(c), the 20-day period shall not begin until the motion is decided.

(2) ~~State bar~~ Disciplinary counsel shall file his or her statement within 15 days of service on ~~state bar~~ disciplinary counsel of the statement of the respondent lawyer, or, if no statement is filed by the respondent lawyer, within 15 days of the expiration of the period for the respondent lawyer to file such a statement.

(3) The respondent lawyer may file a response to a statement of ~~state bar~~ disciplinary counsel within 10 days of service of that statement upon the respondent lawyer.

### RULE 6.3

#### APPEAL BY RESPONDENT LAWYER OR ~~STATE BAR~~ DISCIPLINARY COUNSEL

(a) Transcript To Be Ordered. When Board review is being conducted pursuant to a notice of appeal filed under rule 6.1(b), ~~state bar~~ disciplinary counsel shall cause a transcript of the hearing to be prepared and settled pursuant to rule 6.6, unless the respondent lawyer and ~~state bar~~ disciplinary counsel agree that no transcript or only a partial transcript of the hearing is necessary for review.

(b) Statement in Opposition. The appealing party shall file with the Association a statement in opposition to the decision of the hearing officer or panel (1) within 20 days of service on the respondent lawyer of a copy of the transcript, whether or not the transcript has been settled; or (2) within 20 days of filing of the notice of appeal when the transcript has previously been prepared and served on the respondent lawyer or when the parties have agreed that no transcript is necessary for review, whichever occurs later. Failure to file such a statement within the required period shall constitute an abandonment of the appeal.

(c) Counterstatement. The opposing party shall have 15 days from service on him or her of the statement of the appealing party to file a counterstatement, in response to the issues raised on appeal.

(d) Response. The appealing party may file a response to the counterstatement of the opposing party within 10 days of service of the counterstatement on him or her.

(e) Procedure When Both Parties Appeal. When the respondent lawyer and ~~state bar~~ disciplinary counsel both file notices of appeal pursuant to rule 6.1(b), the respondent lawyer shall be considered the appealing party and ~~state bar~~ disciplinary counsel shall be considered the opposing party for purposes of this rule. In such case the counterstatement of ~~state bar~~ disciplinary counsel may raise any issue for Board review, and the respondent lawyer shall have an additional 5 days to file the response permitted by section (d).

### RULE 6.4

#### REFERENCE TO RECORD

Statements, counterstatements and responses filed pursuant to rules 6.2 and 6.3 shall make specific reference to the record where available, using the designations TR for transcript of hearing, EX for exhibits, and

BF for bar file documents. Copies of any exhibits to which the parties refer in their statements may be appended to those statements.

#### RULE 6.5 REQUEST TO REOPEN PROCEEDINGS

(a) How Made. In making any statement, counterstatement or response as permitted in rules 6.2 and 6.3, the respondent lawyer or ~~state-bar~~ disciplinary counsel may request that the record be reopened to allow the submission of additional evidence, or that an additional hearing be held before the hearing officer or panel on the ground of newly discovered evidence. A request to reopen the record or to conduct an additional hearing shall be supported by affidavit describing in detail the additional evidence sought to be admitted, and the reason or reasons why the same was not presented at the hearing. Such request may be granted or denied in the discretion of the Board.

(b) No Additional Evidence. Except as allowed under section (a), evidence not presented to the hearing officer or panel shall not be presented to the Board by any party without the consent of the opposing party.

#### RULE 6.6 TRANSCRIPT OF HEARING

(a) Ordering Transcript. A transcript or partial transcript of the hearing may be ordered at any time by the hearing officer or panel, respondent lawyer, ~~state-bar~~ disciplinary counsel, or the Board. When prepared, the original of the transcript shall be filed in the office of the Association. ~~State-bar~~ Disciplinary counsel shall cause a copy of the transcript to be served on the respondent lawyer except when the respondent has ordered the transcript.

(b) Proposed Corrections. Within 10 days of service of a copy of the transcript on the respondent lawyer, or within 10 days of the filing of the transcript in the office of the Association when the respondent lawyer has ordered the transcript, ~~state-bar~~ disciplinary counsel and the respondent lawyer may each file with the Association any proposed corrections to the transcript. Each party shall have 5 days after service of the proposed corrections of the opposing party on him or her to file objections to those proposed corrections.

(c) Settlement of Transcript. If either party files objections to any proposed correction as permitted under section (b), the hearing officer or panel chairperson shall, upon review of the proposed corrections and objections, enter an order settling the transcript. In all other cases the transcript shall be deemed settled, and any proposed corrections deemed incorporated therein, if at the expiration of the time to file proposed corrections none is filed, or if at the expiration of the time to file objections to proposed corrections none is filed.

#### RULE 6.7 DECISION OF BOARD

(a) Basis for Review. Review by the Board shall be based on the decision of the hearing officer or panel; any dissent of a hearing panel member; the statements and responses filed by the respondent lawyer and ~~state-bar~~

disciplinary counsel pursuant to rule 6.2 or 6.3; and the transcript or partial transcript of the hearing if one has been prepared. The Board may additionally review any other portion of the record of the matter including bar file documents and exhibits.

(b) Participation. A member of the Board who sat as hearing officer or as a member of a hearing panel, or who sat as a member of a review committee which issued a lawyer an admonition on a matter, shall not be present during the review of that matter by the Board.

(c) Oral Argument. Oral argument before the Board shall be permitted upon the request of either the respondent lawyer or ~~state-bar~~ disciplinary counsel. Such request shall be filed with the Association no later than the date on which the party requesting oral argument is permitted to file his or her final statement, counterstatement or response under rule 6.2 or rule 6.3. Oral argument shall be conducted at such time and place and under such terms as the chairperson of the Board shall direct.

(d) Action by Board. Upon review the Board may adopt, modify or reverse the findings, conclusions or recommendation of the hearing officer or panel. The Board may also reopen the record to allow the admission of additional evidence, or direct that an additional hearing be held with regard to any issue, on its own motion or upon request of either party.

(e) Decision. The action of the Board shall be set forth in a written order filed with the Association, a copy of which shall be served upon the respondent lawyer. If the Board amends, modifies, or reverses any finding, conclusion or recommendation of the hearing officer or panel, the order of the Board shall set forth the reasons for its decision. A member of the Board agreeing with the decision of the majority may file separate concurring reasons.

(f) Dissent. If any member of the Board dissents from the decision of a majority of the Board in a matter in which the majority of the Board recommends suspension or disbarment, he or she shall set forth in writing the reasons for that dissent. Written dissents may be filed in any other case. A copy of any dissent shall be served upon the respondent lawyer, and shall be part of the record.

(g) Decision Final Unless Appealed. A decision of the Board shall become final if neither a notice of appeal nor a petition for review is filed by the respondent lawyer or ~~state-bar~~ disciplinary counsel within the time permitted by Title 7. A decision of the Board shall also become final upon denial by the Supreme Court of a petition for discretionary review.

#### RULE 6.8 CHAIRPERSON MAY MODIFY REQUIREMENTS

Upon written motion filed with the Association by a respondent lawyer or ~~state-bar~~ disciplinary counsel, for good cause shown, the chairperson of the Board may modify the time periods set forth in Title 6, and make such other orders as may appear appropriate to assure fair and orderly Board review, provided, that the time period for filing a notice of appeal set forth in rule 6.1(b) may not be extended or altered.

TITLE 7  
REVIEW BY SUPREME COURT

RULE 7.1  
METHODS OF SEEKING REVIEW

(a) Two Methods for Seeking Review of Board Decisions. There are two methods for seeking review by the Supreme Court of decisions of the Board entered pursuant to rule 6.7(e): (1) review as a matter of right, called "appeal"; and (2) review by permission of the Supreme Court, called "discretionary review." Both "appeal" and "discretionary review" are called "review."

(b) Power of Court Not Affected. This rule shall not affect the power of the Supreme Court to exercise its inherent and exclusive jurisdiction over the lawyer discipline and disability system.

RULE 7.2  
APPEAL

(a) Respondent Lawyer May Appeal Decision Imposing Suspension or Disbarment. The right to appeal a decision of the Board finding misconduct shall be available only to the respondent lawyer, and only in cases where the decision provides for suspension or disbarment.

(b) Notice of Appeal. In order to exercise a right to appeal, the respondent lawyer must file a notice of appeal with the Association within 15 days of service of the decision of the Board on the respondent lawyer.

RULE 7.3  
DISCRETIONARY REVIEW

(a) Decisions Subject to Discretionary Review. Decisions of the Board entered pursuant to rule 6.7(e) which do not provide for suspension or disbarment are subject to review by the Supreme Court only through discretionary review. Discretionary review will be accepted only:

- (1) If the decision of the Board is in conflict with a decision of the Supreme Court; or
- (2) If a significant question of law is involved; or
- (3) If there is no substantial evidence in the record to support a material finding of fact upon which the decision of the Board is based; or
- (4) If the petition involves an issue of substantial public interest that should be determined by the Supreme Court.

(b) Respondent Lawyer May Petition. A respondent lawyer wishing to seek discretionary review by the Supreme Court of a decision of the Board must file a petition for review with the Supreme Court within 25 days of service of the decision of the Board upon the respondent lawyer.

(c) Board of Governors May Authorize Petition by State Bar Disciplinary Counsel. The Board of Governors may authorize state bar disciplinary counsel to seek discretionary review by the Supreme Court of a decision of the Disciplinary Board. In order to seek such review, state bar disciplinary counsel must file a notice of intention to seek discretionary review with the Association within 15 days of service of the decision of the Board upon the respondent lawyer. Within 45 days thereafter

state bar disciplinary counsel must file a petition for review with the Supreme Court, together with an order of the Board of Governors, signed by the president, authorizing such a petition. If the Board of Governors denies such authorization, the respondent lawyer shall be promptly notified.

(d) Content of Petition; Answer; Service; Decision. A petition for review should be substantially in the form prescribed by RAP 13.4(c) for petitions for review by the Supreme Court of decisions of the Court of Appeals, except that references in that rule to the Court of Appeals shall be considered references to the Board. The appendix to the petition or an appendix to an answer or reply may additionally contain any part of the record, including portions of the transcript or exhibits, to which the party refers in the petition, answer or reply. The provisions of RAP 13.4 (d), (e), (f), (g) and (h) shall govern answers and replies to petitions for review and related matters including service and decision by the court. Any party filing a petition for review with the court shall give notice of that fact to the other party.

(e) Acceptance of Review. The Supreme Court accepts discretionary review of a decision of the Board by granting a petition for review. Upon acceptance of review, procedures in the Supreme Court for matters subject to appeal and for matters subject to discretionary review are the same.

RULE 7.4  
APPLICABILITY OF RULES OF APPELLATE  
PROCEDURE

The Rules of Appellate Procedure shall serve as guidance for review conducted pursuant to this rule, except that these rules shall control as to matters specifically dealt with herein.

RULE 7.5  
RECORD TO SUPREME COURT

(a) Transmittal. Upon filing of a notice of appeal by the respondent attorney or upon acceptance of discretionary review by the Supreme Court, the record shall be transmitted to the Supreme Court by the clerk of the Board if one has been appointed, or by state bar disciplinary counsel. Each party shall be provided with a list of the portions of the record so transmitted.

(b) Content. The record transmitted to the court shall consist of:

- (1) Any notice of appeal filed by the respondent attorney, and any notice of intention to seek discretionary review filed by state bar disciplinary counsel;
- (2) The decision of the Board, including any dissents or concurring statements;
- (3) The decision of the hearing officer or panel, including any dissent;
- (4) The transcript or partial transcript of the hearing if one has been prepared;
- (5) Exhibits admitted in evidence;
- (6) Any order assessing costs and expenses and any statements of costs and expenses and exceptions thereto;
- (7) Any other portions of the record, including bar file documents, which appear necessary for full review.

(c) Additions to Record. The respondent lawyer and ~~state-bar~~ disciplinary counsel shall each have the right at any time to request the transmittal of additional portions of the record to the court.

#### RULE 7.6 BRIEFS

(a) Brief Required. The party seeking review shall file a brief setting forth his or her objections to the decision of the Board.

(b) Time for Filing. The brief of the party seeking review should be filed with the Supreme Court within 45 days after he or she is notified of transmittal of the record to the Supreme Court.

(c) Answering Brief. The answering brief of the other party should be filed with the Supreme Court within 30 days after service of the brief of the party seeking review.

(d) Reply Brief. A reply brief of a party seeking review should be filed with the Supreme Court within the sooner of 30 days after service of the answering brief or 14 days before oral argument. A reply brief should be limited to a response to the issues in the brief to which the reply brief is directed.

(e) Briefs When Both Parties Seek Review. When both the respondent lawyer and ~~state-bar~~ disciplinary counsel seek review of a decision of the Board, the respondent lawyer is deemed the party seeking review for the purposes of this rule. In such case ~~state-bar~~ disciplinary counsel may file a brief in reply to any response the respondent lawyer has made to the issues presented by ~~state-bar~~ disciplinary counsel, to be filed with the Supreme Court the sooner of 30 days after service of the reply brief of the respondent lawyer or 14 days before oral argument.

(f) Form of Briefs. Briefs filed pursuant to this rule shall conform as nearly as possible to the requirements of RAP 10.3 and 10.4. Bar file documents should be abbreviated BF and the transcript or partial transcript of the hearing should be abbreviated TR.

(g) Reproduction and Service of Briefs by Clerk. Briefs filed pursuant to this rule shall be reproduced and served by the clerk as provided in RAP 10.5.

#### RULE 7.7 ARGUMENT

(a) Rules Applicable. Oral argument before the Supreme Court shall be conducted under the provisions of Title 11 of the Rules of Appellate Procedure, unless the court shall otherwise direct.

(b) Priority. Disciplinary proceedings shall have priority and shall be set upon compliance with the above rules.

#### RULE 7.8 OPINION

(a) Finality. An opinion in a disciplinary proceeding is final when filed unless the court specifically provides otherwise.

(b) Motion for Reconsideration. A motion for reconsideration may be filed as provided in RAP 12.4, but the

motion will not stay the judgment unless a stay is entered by the court.

#### RULE 7.9 VIOLATION OF RULES

Sanctions for violation of these rules may be imposed on a party pursuant to the provisions of RAP 18.9. Upon dismissal of a review sought by a respondent lawyer pursuant to that rule and expiration of the period to file objections under RAP 17.7, or after dismissal of his or her review by the court if timely objections are filed, the decision of the Board shall become final.

#### TITLE 8 PROTECTION OF PUBLIC WHEN LAWYER UNABLE TO ACT

##### RULE 8.1 NOTICE TO CLIENTS AND OTHERS

(a) Upon Disbarment or Suspension of Certain Kinds. A lawyer who has been disbarred, suspended for more than 60 days, or suspended pursuant to the provisions of Title 3, APR 11, or for nonpayment of dues, shall within 10 days of the effective date of his or her disbarment or suspension:

(1) Notify all clients of his or her inability to act as their lawyer and the reason therefor, and advise them that they should seek legal advice elsewhere; and

(2) Advise all clients involved in litigation or administrative proceedings to seek the prompt substitution of another lawyer. In the event the client does not substitute counsel within 10 days of being notified of the lawyer's inability to act, it shall be the responsibility of the lawyer to advise the court or agency of the lawyer's inability to act; and

(3) Notify the lawyer or lawyers of each adverse party in pending litigation or administrative proceedings, or the adverse party directly if not represented by counsel, of the lawyer's inability to act further on the client's behalf; and

(4) Provide clients or their substituted counsel upon request with their files and other documents of the client in the possession of the lawyer, regardless of any possible claim of lien under RCW 60.40.

(b) Upon Transfer to Disability Inactive Status. A lawyer transferred to disability inactive status, or his or her guardian if one has been appointed, shall give all notices required by section (a), except that such notices need not refer to disability.

(c) Upon Suspension for 60 Days or Less. A lawyer who has been suspended for 60 days or less shall within 10 days of the effective date of his or her suspension:

(1) Notify all clients involved in litigation or administrative proceedings, and the lawyer or lawyers for each adverse party (or the adverse party directly if not represented by counsel) in such litigation or proceeding, of the suspension and the reason therefor, and of his or her consequent inability to act as a lawyer after the effective date of the suspension, and shall advise all such clients to seek prompt substitution of another lawyer. In the event the client does not substitute counsel within 10 days of being notified of the lawyer's inability to act, it

shall be the responsibility of the lawyer to advise the court or agency of the lawyer's inability to act; and

(2) Notify all other clients of his or her suspension and the reason therefor and consequent inability to act during the period of that suspension. The notice shall advise the clients to seek legal advice elsewhere if they feel they need such advice during the period of the lawyer's suspension; and

(3) Provide clients or their substituted counsel upon request with their files and other documents of the client in the possession of the lawyer, regardless of any possible claim of lien under RCW 60.40.

(d) Address of Client. All notices to lawyers, adverse parties, courts or agencies as required by sections (a), (b), or (c) shall contain the name and last known address of the person being represented by the lawyer, unless disclosure would violate a confidence or secret of the client. If the name and address are omitted, as permitted herein, the client shall be advised that so long as his or her address remains undisclosed and no new attorney is substituted, the client may be served by leaving papers with the clerk of the court pursuant to CR 5 (b)(1) in pending superior court actions, and that comparable provisions may allow similar service in other court proceedings or administrative actions.

#### RULE 8.2

##### LAWYER TO DISCONTINUE PRACTICE

A disbarred or suspended lawyer, or a lawyer transferred to disability inactive status, shall not accept any new retainer, give any legal advice, or act as the lawyer for another in a pending case or legal matter of any nature after the effective date of his or her disbarment, suspension, or transfer to disability inactive status, and shall also take whatever steps may be necessary to avoid any possibility that any person may think that he or she is a lawyer authorized to practice law. This rule shall not preclude a disbarred or suspended lawyer, or a lawyer transferred to disability inactive status, from providing information on the facts of a case and its status to a succeeding lawyer, and such information shall be provided on request and without charge.

#### RULE 8.3

##### AFFIDAVIT OF COMPLIANCE

Within 25 days after the effective date of his or her disbarment, suspension, or transfer to disability inactive status, the lawyer shall file with the Association an affidavit stating that he or she has fully complied with the provisions of these rules. The affidavit shall also set forth the residence or other address of the lawyer to whom communications may thereafter be directed. The lawyer shall attach to the affidavit copies of the form letters of notification sent to the lawyer's clients, and to opposing counsel or opposing parties, and copies of letters to any court, together with a list of names and addresses of all clients and adverse parties or their lawyers to whom notices were sent.

#### RULE 8.4

##### PUBLIC NOTICE

(a) Publication. The Association shall cause a notice of the disbarment, suspension, or transfer to disability status of a lawyer to be published in the Washington State Bar News and a newspaper of general circulation in the county in which the lawyer maintained his or her practice, except that in the case of transfer to disability inactive status no reference shall be made to disability.

(b) Notice to Judges. The Association shall promptly notify the presiding judge of the superior court of the county in which the lawyer maintained his or her practice of the lawyer's disbarment, suspension or transfer to disability inactive status, and may similarly notify the presiding judge of any district court located in the county where the lawyer practiced, or the judge of any other court in which the lawyer may have practiced or is known to have practiced.

(c) Other Notice. The notice provisions of this rule shall be in addition to the notice requirements of rule 11.2, which shall also be followed.

#### RULE 8.5

##### LAWYER TO KEEP RECORDS OF COMPLIANCE

A lawyer who has been disbarred, suspended, or transferred to disability inactive status must maintain written records of the various steps taken by him or her under these rules, so that upon any subsequent proceeding instituted by or against him or her proof of compliance with these rules will be available.

#### RULE 8.6

##### APPOINTMENT OF COUNSEL TO PROTECT CLIENTS' INTERESTS

(a) Appointment. Whenever a lawyer has been transferred to disability inactive status, suspended, or disbarred, and fails to carry out the obligations of this rule or fails to protect his or her clients' interests, or whenever a lawyer disappears or dies, the chairperson of the Board may appoint a lawyer or lawyers to protect the clients' interests, unless a partner, personal representative or other responsible person appears to be properly protecting those interests. The appointment shall be made upon application of the Association or any interested party and upon proper proof of facts. The appointed lawyer or lawyers shall take possession of the necessary files and records and take such action as seems indicated to protect the clients' interests or as required under these rules. Such action may include but is not limited to assuming control of trust accounts or other financial affairs. Any bank or other person honoring the authority of the appointed lawyer or lawyers shall be exonerated from any liability resulting therefrom.

(b) Costs. Payment of any costs incurred by the Association pursuant to this rule may be made a condition of reinstatement of a disbarred lawyer or a lawyer transferred to disability inactive status, or may be ordered as restitution in a disciplinary proceeding brought against a suspended lawyer for failure to comply with rule 8.1.

TITLE 9  
REINSTATEMENT AFTER DISBARMENT  
RULE 9.1  
RESTRICTIONS AGAINST PETITIONING

(a) When Petition May Be Filed. No petition for reinstatement shall be filed within a period of 5 years after disbarment or within a period of 2 years after an adverse decision of the Supreme Court upon a former petition, or within a period of 1 year after an adverse recommendation of the Board of Governors Character and Fitness Committee of the Washington State Bar Association on a former petition when that recommendation is not submitted to the Supreme Court. If prior to disbarment the lawyer was suspended from the practice of law pursuant to the provisions of Title 3, or any comparable rule, the period of such suspension shall be credited toward the 5 years referred to above.

(b) Payment of Obligations. No disbarred lawyer may file a petition for reinstatement until costs and expenses assessed pursuant to these rules, and restitution ordered as provided herein, have been paid and until amounts paid out of the Clients' Security Fund as a result of the conduct of the petitioner have been repaid to the Association, or until periodic payment plans for costs and expenses, restitution and repayment to the Clients' Security Fund have been entered into by agreement between the respondent lawyer and state bar disciplinary counsel.

RULE 9.2  
REVERSAL OF CONVICTION

If a lawyer has been disbarred solely because of his or her conviction of a crime and the conviction is later reversed and the charges dismissed on their merits, the Supreme Court may in its discretion, upon direct application by the lawyer, enter an order reinstating the lawyer to active status. At the time such direct application is filed with the court a copy shall be filed with the Association.

~~RULE 9.3  
FORM OF PETITION~~

~~A petition for reinstatement as a member of the Association after disbarment shall be in writing in such form as the Board of Governors may prescribe. The petition shall be filed with the Board of Governors. The petition shall set forth the age, residence and address of the petitioner, the date of disbarment, and a concise statement of facts claimed to justify reinstatement. The petition shall be accompanied by the total fees required of a lawyer applicant under the Admission to Practice Rules.~~

RULE 9.3  
CHARACTER AND FITNESS COMMITTEE

(a) Membership.

(1) Composition. The Committee shall consist of not less than three nonlawyer members, appointed by the Supreme Court, and not less than one lawyer member from each congressional district, appointed by the Board of Governors.

(2) Qualifications. Lawyer members must have been active members of the Association for at least 7 years.

(3) Quorum. A majority of the Committee members shall constitute a quorum. Given a quorum, the concurrence of a majority of those present shall constitute action of the Committee.

(4) Disqualification. In the event a complaint is made to the Association alleging an act of misconduct by a lawyer member of the Committee, such member shall take a leave of absence from the Committee until the matter is resolved, unless otherwise directed by the Board of Governors.

(5) Voting. Each member, whether nonlawyer or lawyer, shall have one vote.

(b) Terms of Office. The term of office for a member of the Committee shall be 3 years. Newly created Committee positions may be filled by appointments of less than 3 years, as designated by the court or the Board of Governors, to permit as equal a number of positions as possible to be filled each year. All terms of office begin October 1 and end September 30 or when a successor has been appointed, whichever occurs later. Members may not serve more than one term except as otherwise provided in these rules. Members heretofore appointed shall continue to serve until replaced.

(c) Chairperson. The Board of Governors shall annually designate one lawyer member of the Committee to act as chairperson another as vice-chairperson. The vice-chairperson shall serve in the absence of or at the request of the chairperson.

(d) Vacancies. Vacancies in lawyer membership on the Committee and in the office of the chairperson and the vice-chairperson shall be filled by the Board of Governors. Vacancies in nonlawyer membership shall be filled by the Supreme Court. A person appointed to fill a vacancy shall complete the unexpired term of the person he or she replaces, and if that unexpired term is less than 18 months he or she may be reappointed to a consecutive term.

(e) Pro Tempore Members. When a member of the Committee is disqualified or unable to function on a case for good cause, the chairperson of the Committee may, by written order, designate a member pro tempore to sit with the Committee to hear and determine the cause. A member pro tempore may be appointed from among those person who have previously served as members of the Character and Fitness Committee, or from among lawyers appointed as alternate Board members by the Board of Governors and nonlawyers appointed as alternate Committee members by the Supreme Court. A lawyer shall be appointed to substitute for a lawyer member of the Committee, and a nonlawyer to substitute for a nonlawyer member of the Board.

(f) Authority of Committee. The Committee shall have the power and authority to:

(1) Accept referrals from the Executive Director of the Association by concerning itself with matters of character and fitness bearing upon the qualification of applicants for reinstatement.

(2) Review each Petition for Reinstatement to practice law in the state of Washington.



(3) Investigate matters relevant to the reinstatement of any applicant and conduct hearings concerning such matters.

(4) The Committee's recommendation to grant the application shall be forwarded to the Supreme Court. The Committee's recommendation to deny the application may be forwarded to the Board of Governors for review upon request of the applicant. All recommendations shall contain findings of fact, conclusions of law, and rationale for the recommendation.

(5) Perform such other functions and take such other actions as provided in these rules or as may be delegated to it by the Board of Governors or Supreme Court, or as may be necessary and proper to carry out its duties.

(g) Meetings. The Committee shall hold meetings at such times and places as it may determine. Where the chairperson of the Committee determines that prompt action is necessary for protection of the public, and that circumstances do not permit a full meeting of the Committee, the Committee may vote on a matter otherwise ready for review without meeting together, through telephone or written communication.

(h) Clerk. The Executive Director of the Association, under the direction of the Board of Governors, may appoint a suitable person or persons to act as clerk to the Committee, and to assist the Committee in carrying out its functions under these rules.

#### **RULE 9.4 INVESTIGATION**

The Board of Governors may in its discretion refer the petition for reinstatement for investigation and report to the Board by state bar counsel, special district counsel, or by such other person or persons as may be determined by the Board of Governors.

#### **RULE 9.4 PETITIONS AND INVESTIGATIONS**

(a) Form of Petition. A petition for reinstatement as a member of the Association after disbarment shall be in writing in such form as the Character and Fitness Committee may prescribe. The petition shall be filed with the Character and Fitness Committee. The petition shall set forth the age, residence and address of the petitioner, the date of disbarment, a concise statement of facts claimed to justify reinstatement. The petition shall be accompanied by the total fees required of a lawyer applicant under the Admission to Practice Rules.

(b) Investigations. The Character and Fitness Committee may in its discretion refer the petition for reinstatement for investigation and report to the Character and Fitness Committee by disciplinary counsel, special district counsel, or by such other person or persons as may be determined by the Character and Fitness Committee.

#### **RULE 9.5 HEARING BEFORE BOARD OF GOVERNORS CHARACTER AND FITNESS COMMITTEE**

(a) Notice. The Board of Governors Character and Fitness Committee may fix a time and place for a hearing on the petition, and shall serve notice thereof 10 days

prior to the hearing upon the petitioner and upon such other persons as may be ordered by the Board of Governors Character and Fitness Committee. Notice of the hearing shall also be published at least once in the Washington State Bar News or such other newspaper or periodical as the Board of Governors Character and Fitness Committee may direct. Such published notice shall contain a statement that a petition for reinstatement has been filed and shall give the date fixed for the hearing.

(b) Statement in Support or Opposition. On or prior to the date of hearing, anyone wishing to do so may file with the Board of Governors Character and Fitness Committee a written statement for or against reinstatement the petition, such statements to set forth factual matters showing that the petitioner does or does not meet the requirements of rule 9.6(a). Except by its leave no person other than the petitioner or petitioner's counsel shall be heard orally by the Board of Governors.

#### **RULE 9.6 ACTION BY BOARD OF GOVERNORS CHARACTER AND FITNESS COMMITTEE**

(a) Requirements for Favorable Recommendation. Reinstatement may be recommended by the Board of Governors Character and Fitness Committee only upon an affirmative showing that the petitioner possesses the qualifications and meets the requirements as set forth in the Admission to Practice Rules for lawyer applicants, and that his or her reinstatement it will not be detrimental to the integrity and standing of the judicial system or to the administration of justice, or be contrary to the public interest.

(b) Action on Recommendation. The recommendation of the Board of Governors Character and Fitness Committee shall be served upon the petitioner. If the Board Committee recommends reinstatement, the record and recommendation shall be transmitted to the Supreme Court for disposition. If the Board Committee recommends against reinstatement, the record and recommendation shall be retained in the office of the Association unless the petitioner requests that it be submitted to the Supreme Court. If the petitioner so requests, the record and recommendation shall be transmitted to the Supreme Court for disposition. If the petitioner does not so request, the bar examination fee shall be refunded to the petitioner, but the petitioner shall still be responsible for payment of the costs incidental to the reinstatement proceeding as directed by the Board of Governors Character and Fitness Committee.

#### **RULE 9.7 ACTION ON SUPREME COURT'S DETERMINATION**

(a) Petition Approved. If the petition for reinstatement is granted by the Supreme Court, the reinstatement shall be subject to the petitioner's taking and passing the bar examination and paying the costs incidental to the reinstatement proceeding as directed by the Supreme Court.

(b) Petition Denied. If the petition for reinstatement is denied, the bar examination fee shall be refunded to the petitioner, but the petitioner shall still be responsible



for payment of the costs incidental to the reinstatement proceeding.

## TITLE 10

### TRANSFER TO DISABILITY INACTIVE STATUS

#### RULE 10.1

##### AUTOMATIC TRANSFER

(a) Grounds. In the event that an active lawyer (1) has been found to be incapable of assisting in his or her own defense in a criminal action; or (2) has been acquitted of a crime on the ground of insanity; or (3) has had a guardian (but not a limited guardian) appointed for his or her person or estate upon a finding of incompetency; or (4) has been found to be mentally incapable of conducting the practice of law in any other jurisdiction, he or she shall automatically be transferred from active to disability inactive membership status upon receipt by the Association of a certified copy of the judgment, order or other appropriate document demonstrating that one or more of the above events has occurred.

(b) Notice to Lawyer. The disabled lawyer and his or her guardian, if one has been appointed, shall forthwith be notified of the transfer to disability inactive status. The Supreme Court shall be notified of the transfer to disability inactive status and shall be provided with a copy of the judgment, order or other appropriate document upon which the transfer was based.

#### RULE 10.2

##### DISCRETIONARY TRANSFER

(a) Review Committee May Order Inquiry. When it appears to a review committee that there is reasonable cause to believe that an active lawyer is unable adequately to practice law because of insanity, mental illness, senility, excessive use of alcohol or drugs, or other mental or physical incapacity, the committee shall order that a hearing be held to inquire into the capacity of the lawyer to practice law.

(b) Inquiry During Course of Disciplinary Proceedings. When it appears to the Board, a hearing officer or a hearing panel that there is reasonable cause to believe that a respondent lawyer is incapable of conducting a proper defense to a disciplinary proceeding against him or her because of insanity, mental illness, senility, excessive use of alcohol or drugs, or other mental or physical incapacity, the Board, officer or panel shall order that a supplemental hearing be held to inquire into the capacity of the lawyer to conduct a proper defense. Such hearing shall be automatic where the respondent lawyer alleges in the course of a disciplinary proceeding that he or she is unable to conduct a proper defense because of mental or physical incapacity.

(c) Procedure. Proceedings conducted pursuant to this rule are not disciplinary proceedings, but shall be conducted under the same procedural rules as disciplinary proceedings. Any hearing held under section (b) above may be treated either as a new proceeding or as part of an existing proceeding, in the discretion of the Board, hearing officer or panel, and the disciplinary proceedings shall be held in abeyance pending the outcome of the

supplemental proceeding. A recommendation of a hearing officer or panel that a lawyer be transferred to inactive status under this rule shall be treated as a recommendation for suspension for the procedural purposes of these rules, including rule 6.1(a) and rule 7.2(a).

(d) Appointment of Counsel. In the event the respondent lawyer does not appear by counsel within the time required by these rules for the filing of an answer, or within 20 days of being notified of the issues to be considered in a supplemental proceeding under section (b), the chairperson of the Board shall appoint a member of the Association as counsel for such respondent lawyer.

(e) Finding of Incapacity. If after review of the decision of the hearing officer or panel, the Board finds that a lawyer does not have adequate mental or physical capacity to practice law or to conduct a proper defense to disciplinary charges, it shall enter an order immediately transferring the lawyer to disability inactive status. Such transfer shall become effective upon service of such order upon the lawyer or his or her counsel.

(f) Appeal to Supreme Court. The lawyer may appeal an order of transfer to disability inactive status pursuant to the provisions of rule 7.2. The order of the Board shall remain in effect, regardless of the pendency of such appeal, unless and until reversed by the Supreme Court.

(g) Proceedings Confidential. All proceedings conducted pursuant to this rule shall be confidential.

#### RULE 10.3

##### REINSTATEMENT TO ACTIVE STATUS

(a) Restriction, Right of Petition and Burden. No lawyer transferred to disability inactive status may resume active status except by order of the Board or the Supreme Court. Any lawyer transferred to disability inactive status shall be entitled to petition the Board for transfer to active status. The lawyer shall have the burden of showing that the disability has been removed.

(b) Petition and Initial Review. The petition for reinstatement shall set forth the facts demonstrating that the disability has been removed. The petition shall be filed with the Board at the office of the Association. Upon the filing of the petition the chairperson of the Board shall direct whatever action appears necessary or proper to determine whether the disability has been removed. Such actions include but are not limited to direction: (1) that ~~state bar~~ disciplinary counsel or any other person conduct an investigation and file a report; (2) that an examination of the lawyer be conducted by a qualified expert or experts; and (3) that a hearing be held before the Board, or before a hearing officer or panel. Such a hearing shall be conducted under the same procedural rules as disciplinary proceedings.

(c) Waiver of Doctor-Patient Privilege. The filing of a petition for reinstatement to active status by a lawyer transferred to disability inactive status shall be deemed to constitute a waiver of any doctor-patient privilege with respect to any treatment of the lawyer during the period of his or her disability. The lawyer shall be required to disclose the name of each psychiatrist, psychologist, physician, or other person, and each hospital or other institution by whom or in which the lawyer has been examined or treated since his or her transfer to

disability inactive status. The lawyer shall furnish, if requested by the Board or ~~state bar~~ disciplinary counsel, written consent to each person or hospital to divulge information and records relating to the disability.

(d) Review of Record. Prior to the submission of the petition and any report to the Board the lawyer shall have a reasonable opportunity to review the report and to make any additional submissions he or she deems desirable.

(e) Board Review. The Board shall review the petition and report as expeditiously as possible and take one or more of the following actions:

(1) Grant the petition;

(2) Direct whatever additional action the Board deems necessary or proper to determine whether the disability has been removed;

(3) Direct that the lawyer establish proof of competence and learning in the law, which proof may include certification by the bar examiners of his or her successful completion of an examination for admission to practice;

(4) Deny the petition, but no such denial shall occur except as hereinafter provided without the lawyer having the opportunity for a hearing before the Board, or before a hearing officer or panel. A hearing is not necessary if the lawyer has failed to state a prima facie case for reinstatement in his or her petition, or if the petition does not indicate a material change of circumstance since a previous denial of a petition for reinstatement filed by the lawyer;

(5) Direct the lawyer to pay the costs of the reinstatement proceedings.

(f) Petition Granted. If the petition for reinstatement is granted, the lawyer shall immediately be transferred to active status and the Supreme Court notified thereof. If a disciplinary proceeding has been held in abeyance because of the disability transfer, the proceeding shall go forward upon reinstatement.

(g) Review by Supreme Court. If the petition for reinstatement is not granted, the respondent lawyer shall have the right to appeal the decision of the Board to the Supreme Court, by filing a notice of appeal with the Association within 15 days of service of the decision of the Board upon the respondent lawyer. Review shall be conducted pursuant to the procedures of Title 7.

## TITLE 11

### ACCESS TO DISCIPLINARY INFORMATION

#### RULE 11.1

#### PENDING INVESTIGATIONS AND PROCEEDINGS

(a) Investigations Confidential. An investigation into an alleged act of misconduct by a lawyer shall be confidential except as necessary to conduct the investigation or to keep a complainant advised of the status of a matter, but the pendency, subject matter, and status of an investigation may be disclosed if:

(1) Both the respondent lawyer and the complainant have waived confidentiality; or

(2) The proceeding is based upon the conviction of a crime; or

(3) A review panel finds that the investigation is based upon allegations that have become generally known to the public.

In furtherance of its supervisory function, and not in derogation of the foregoing, the Board of Governors shall have access to all records and information of the disciplinary department.

(b) Release May Be Authorized. The Board of Governors, or the Executive Director acting under the direction of the Board, may authorize the general or limited release of any confidential information obtained during the course of an investigation when to do so appears necessary to protect the interests of clients or other persons, the public, or the integrity of the Bar. A respondent lawyer shall be given notice of a decision to release information under this section prior to its release unless the Board, or the Executive Director acting under the direction of the Board, finds that such notice would jeopardize serious interests of any person or the public, or that the delay caused by giving the notice to the respondent would be detrimental to the integrity of the Bar.

(c) Proceedings Public. Upon the filing and service of a formal complaint and after the lawyer has answered that complaint, or failed to answer within the time required, a disciplinary proceeding shall be public, subject to the provisions of any protective order as may be entered pursuant to section (f). The filing of a motion for a protective order shall stay the provisions of this rule with regard to any matter sought to be kept confidential in that motion, and the motion itself shall be confidential, until ruled upon.

(d) Matters Which Are Public. In a matter which is public pursuant to section (c), any person may have access to the contents of the bar file in the pending proceeding, may attend any hearing on the charges against the attorney, except a hearing on a motion, and may attend any oral argument before the Board conducted pursuant to rule 6.7(c). In any disciplinary matter referred to the Supreme Court, the file, record, briefs, and argument in the case shall also be public except to the extent previously made confidential by a protective order or as otherwise ordered by the court.

(e) Matters Which Are Not Public. In no case shall deliberations of a hearing panel, board or court, or matters made confidential by a protective order, be public.

(f) Protective Orders. In order to protect a compelling interest of a complainant grievant, witness, third party, or respondent, the hearing officer or panel chairperson to whom a matter is assigned, the chairperson of a review committee or of the Board when a matter is before a committee or the Board for review, or the president of the Association in the case of a petition for reinstatement after disbarment, may, upon motion and for good cause shown, issue a protective order prohibiting the disclosure of specific information or specific documents or pleadings, and direct that the proceedings be conducted so as to implement the order.

(g) Application to Stipulations. A stipulation entered into pursuant to rule 4.14 shall be confidential until approved by a review committee or the Board, except that a complainant grievant may be advised concerning a

stipulation and its proposed or actual content at any time. A stipulation which is approved by a review committee or the Board shall be public, except that a stipulation entered into prior to the filing of a formal complaint and which provides for dismissal or conditional dismissal of a complaint grievance without the imposition of a disciplinary sanction shall be confidential, unless and until proceedings are instituted for failure to comply with the conditions of the stipulation.

(h) Application to Title 3 Suspensions. Proceedings for suspension of a lawyer for conviction of a crime pursuant to rule 3.1 shall be public upon the filing of the petition. Proceedings for suspension of a lawyer for other causes pursuant to rule 3.2 shall be public upon issuance of a show cause order by the Chief Justice of the Supreme Court.

(i) Application for Disability Proceedings. Proceedings for transfer to and from disability inactive status are confidential. However, a complainant grievant may be advised of disability proceedings or transfers affecting a lawyer complained against. The fact that a lawyer is on inactive status, or has been reinstated to active status, is public.

(j) Application to Reinstatement Proceedings. A petition for reinstatement after disbarment shall be a public proceeding within this rule from the time the petition is filed.

(k) Regulations. Public access to file materials and proceedings as permitted by this rule may be subject to reasonable regulation as to time, place and circumstances. Certified copies of public bar file documents shall be made available at the same rate as certified copies of superior court records. Uncertified copies of public bar file documents shall be made available at a rate to be set by the Executive Director of the Association.

(l) Wrongful Disclosure. Disclosure by any person involved with an investigation or proceeding either as an officer or agent of the Association (including but not limited to its staff, members of the Board of Governors, the Disciplinary Board, review committees, hearing panels, hearing officers, ~~state bar~~ disciplinary counsel, special district counsel, a lawyer appointed pursuant to rule 8.6 or 10.2(d), or any other individual acting under authority of these rules) of any information concerning a pending or completed investigation or proceeding, except as permitted by these rules, may subject that person to an action for contempt of the Supreme Court. When the person is a lawyer, such wrongful disclosure may also be grounds for discipline.

(m) Release to Client's Security Program Committee. Nothing in these rules shall prohibit the release of information obtained during the course of an investigation to the Client's Security Program Committee concerning applications which are pending before the Committee. The Committee shall treat such information as confidential unless release is authorized by this rule or the Board of Governors.

#### RULE 11.2 NOTICE OF DISCIPLINE

(a) Discipline To Be Public. In any case in which a disciplinary sanction is imposed upon a lawyer pursuant

to these rules, whether after a hearing or by stipulation, the nature of the sanction and the decision or stipulation upon which it is based shall be public. When a lawyer is permitted to resign with discipline pending, the fact of the resignation with discipline pending shall also be public.

(b) Notice to Supreme Court. A copy of any decision imposing a disciplinary sanction on a lawyer shall be filed with the Supreme Court when that decision becomes final.

(c) Other Notices. Notice of the imposition of a disciplinary sanction on a lawyer shall also be given to the following authorities, in such form as may appear appropriate:

(1) The lawyer discipline authority or highest court in any jurisdiction where the lawyer is believed to be admitted to practice;

(2) The chief judge of each federal district court in the state of Washington, and the chief judge of the United States Court of Appeals for the Ninth Circuit;

(3) The National Discipline Data Bank.

(d) Notices of Suspension, Disbarment, or Disability Inactive Status. Additional notices in any case where a lawyer is suspended, disbarred, or transferred to disability inactive status shall be given as provided in rule 8.4.

(e) Person Responsible. The clerk of the Board if one has been appointed, or ~~state bar~~ disciplinary counsel, shall be responsible for providing the notices set forth in this rule.

(f) Discipline Under Prior Rules. Discipline imposed on a lawyer under prior rules of this state which was confidential when imposed shall remain confidential, regardless of the provisions of section (a). A record of confidential discipline may be kept confidential during the course of proceedings under these rules, or in connection with the consideration of a stipulation under rule 4.14, through a protective order issued under rule 11.1(f).

#### TITLE 12 GENERAL PROVISIONS RULE 12.1 SERVICE OF PAPERS

(a) Service Required. Every pleading, every paper relating to discovery, every written request or motion other than one which may be heard ex parte, and every similar paper or document issued by ~~state bar~~ disciplinary counsel or the respondent lawyer under any provision of these rules shall be served on the opposing party (the respondent lawyer or ~~state bar~~ disciplinary counsel as the case may be) as follows, unless personal service is required or unless these rules specifically provide otherwise:

(1) On the respondent lawyer, by mailing the same postage prepaid to the lawyer or his or her attorney of record, or leaving the same, at the address set forth in the answer or in a notice of appearance filed by an attorney on behalf of the lawyer or at the address set forth in any subsequent document filed by the lawyer or his or her attorney; or, in the absence of an answer, by mailing the same postage prepaid to the lawyer or leaving the same at his or her address on file with the Association;

(2) On ~~state bar~~ disciplinary counsel, by mailing the same postage prepaid, or leaving the same, at the address of the Association or such other address as ~~state bar~~ disciplinary counsel may request;

(3) Service by mail under this section shall be by certified or registered mail, return receipt requested, unless the parties agree otherwise, except that when one or more certified mailings properly made pursuant to this rule is returned as unclaimed service may be made by regular first class mail. Service properly made as herein provided shall be effective regardless of whether the person to whom the mail is addressed actually receives it.

(b) Personal Service. When personal service upon a respondent lawyer is required by these rules, it shall be accomplished as follows:

(1) If the respondent lawyer is found in the state of Washington, by personal service upon him or her in the manner required for personal service of a summons in a civil action in the superior court.

(2) If the respondent lawyer cannot be found in the state of Washington, service can be made either by (i) leaving a copy at his or her place of usual abode in the state of Washington with some person of suitable age and discretion then resident therein; or (ii) mailing by registered or certified mail, postage prepaid, a copy addressed to him or her at his or her last known place of abode, or office address maintained by him or her for the practice of law, or post office address or address on file with the Association.

(3) If the respondent lawyer is found outside of the state of Washington, then by service as set forth in (1) or (2) above.

(c) Service Where Question of Mental Competence. If a guardian or guardian ad litem has been duly appointed for a respondent lawyer who has been judicially declared to be of unsound mind or incapable of conducting his or her own affairs, service under sections 12.1 (a) and (b) above shall also be made on the guardian or guardian ad litem.

(d) Proof of Service. Proof of service when personal service is required shall be made by affidavit of service, sheriff's return of service, or a signed acknowledgment of service. Proof of service in other cases may alternatively be made by certificate of an attorney similar to that allowed by CR 5 (b)(2)(B), which certificate shall state the form of mail used. Proof of service in all cases shall be filed in the office of the Association, or with the Supreme Court in matters before the court, but need not be served on the opposing party.

#### RULE 12.2

#### FILING; COPY TO HEARING OFFICER; ORDERS

(a) Filing Originals; Copies to Hearing Officer or Panel. The original of any pleading, motion, discovery document or other paper authorized by these rules, except in matters before the Supreme Court, shall be filed in the office of the Association. Filing may be made by first class mail, and shall be deemed accomplished on the date of mailing. In addition to service upon the opposing party as required by rule 12.1(a), in cases where a hearing is pending a copy of any such paper except discovery

documents shall be sent or delivered to the hearing officer or panel chairperson, or to each member of a hearing panel where required by these rules. Service on a hearing officer or panel may be by regular first class mail.

(b) Filing and Service of Orders. Any written order, decision or ruling entered under these rules, except an order of the Supreme Court or an informal ruling issued pursuant to rule 4.8(e), shall be filed with the Association, and shall be served upon the respondent lawyer by the clerk to the Board if one has been appointed, or by ~~state bar~~ disciplinary counsel as provided in rule 12.1(a).

#### RULE 12.3 PAPERS

All pleadings or other papers under these rules must be typewritten or printed, double spaced, on good quality 8 1/2- by 11-inch paper. The use of letter-size copies of exhibits is encouraged if it does not impair legibility.

#### RULE 12.4 EXPENSES

(a) Board, Special District Counsel, Hearing Officer or Panel. The members of the Board, special district counsel, hearing officers and hearing panel members shall receive no compensation for their services, except as hereinafter provided, but expenses incurred in connection with their duties shall be paid from the funds of the Association subject to any limitation established by resolution of the Board of Governors. The Board of Governors shall have discretionary authority to provide compensation to hearing officers or hearing panel members in cases which are unusually time consuming or where some other especially burdensome circumstance is involved.

(b) Special Appointments. The fees for counsel appointed pursuant to rule 8.6 or rule 10.2(d) and costs or expenses reasonably incurred by such counsel under authority of these rules shall be paid by the Association.

#### RULE 12.5 RESTRICTIONS ON REPRESENTATION OF RESPONDENT

A former president of the Association, a former member of the Board of Governors, or a former member of the Disciplinary Board shall not represent a respondent lawyer in any proceeding under these rules until 3 years have elapsed following expiration of his or her term of office.

#### RULE 12.6 RECIPROCAL DISCIPLINE

(a) Supreme Court Action. Upon receipt of a certified copy of an order demonstrating that a lawyer admitted to practice in this state has been disciplined in another jurisdiction, the Supreme Court shall forthwith direct the Association to issue a notice directed to the respondent lawyer containing:

(1) A copy of the order from the other jurisdiction; and

(2) An order directing that the respondent lawyer inform the court within 30 days from service of the notice

of any claim that the imposition of the identical discipline in this state would be unwarranted, and if so the reasons therefor. The notice shall be personally served on the respondent lawyer as provided in rule 12.1(b).

(b) Deferral. In the event the discipline imposed in the other jurisdiction has been stayed there, any reciprocal discipline imposed in this state shall be deferred until the stay expires.

(c) Conclusive Effect. In all other respects, a final adjudication in another jurisdiction that a lawyer has been guilty of misconduct shall establish conclusively the misconduct for purposes of a disciplinary proceeding in this state.

#### RULE 12.7 REMOVAL OF APPOINTEES

The power granted by these rules to any person, committee or board to make any appointment shall include the power to remove the person appointed whenever that person appears unwilling or unable to perform his or her duties, or for any other cause, and to fill the resulting vacancy.

#### RULE 12.8 MAINTENANCE OF RECORDS

(a) Permanent Records. In any matter in which a disciplinary sanction has been imposed on a lawyer, the bar file and transcripts in the proceeding shall be permanent records of the Association and/ or of the Supreme Court. Related file materials, including investigatory files, may be maintained in the discretion of ~~state-bar~~ disciplinary counsel. Exhibits may be returned to the party supplying them, but copies shall be retained where possible.

(b) Destruction of Files. In any matter in which a complaint grievance or investigation has been dismissed without the imposition of a disciplinary sanction, whether following a hearing or otherwise, file materials relating to the matter may be destroyed 5 3 years after the dismissal first occurred, and shall be destroyed at that time upon the request of the lawyer involved unless the files are being used in an ongoing investigation or unless other good cause exists for retention. The Board of Governors shall rule on a request by a lawyer for destruction of files pursuant to this rule when that request is opposed by ~~state-bar~~ disciplinary counsel.

(c) Retention of Docket. When a file on a matter has been destroyed pursuant to section (b), the Association may retain a docket record of the matter for statistical purposes only. That docket record shall not include the name or other identification of the lawyer complained against.

(d) Deceased Lawyers. Records and files relating to a lawyer who has died, including permanent records, may be destroyed at any time in the discretion of ~~state-bar~~ disciplinary counsel.

#### RULE 12.9 CONFIDENTIAL SOURCES

When a complaint grievance is made or information provided to ~~state-bar~~ disciplinary counsel or the Association regarding a possible act of misconduct by a lawyer,

or possible mental or physical inability of a lawyer to conduct his or her practice of law, and the person making the complaint grievance or providing the information requests that his or her identity be kept confidential, an investigation may be conducted in the name of the Association. Unless otherwise ordered, the identity of the person complaining or providing information, the "confidential source," shall not be disclosed to the lawyer, either during the investigation or in subsequent formal proceedings if such proceedings are ordered. The chairperson of the Board, the chairperson of a review committee, or a hearing officer or panel chairperson before whom a matter is pending may order ~~state-bar~~ disciplinary counsel to reveal the identity of a confidential source upon motion of the lawyer, where after private examination of ~~state-bar~~ disciplinary counsel and any requested documents or file materials it appears necessary to reveal the identity of the confidential source to the lawyer to enable the lawyer to conduct a proper defense to the charges against him or her.

#### RULE 12.10 STATUTE OF LIMITATION

There is no statute of limitation or other time limitation restricting the bringing of a proceeding under these rules, but the passage of time since an act of misconduct occurred may be considered in determining what if any action or sanction is warranted.

#### RULE 12.11 EXONERATION FROM LIABILITY

(a) Association and Its Agents. No cause of action shall accrue in favor of a respondent lawyer or any other person, arising from an investigation or proceeding pursuant to these rules, against the Association, or its officers or agents (including but not limited to its staff, members of the Board of Governors, the Disciplinary Board, review committees, hearing panels, hearing officers, ~~state-bar~~ disciplinary counsel, special district counsel, a lawyer appointed pursuant to rule 8.6 or 10.2(d), probation officers appointed pursuant to rule 5.2, staff and peer counselors of the Lawyers' Assistance Program, or any other individual acting under authority of these rules) provided only that the Association or individual shall have acted in good faith. The burden of proving bad faith in this context shall be upon the party asserting it. The Association shall provide defense to any action brought against an officer or agent of the Association for actions taken in good faith under these rules and shall bear the costs of that defense.

(b) Complainants Grievants and Witnesses. Communications to the Association, Board of Governors, Disciplinary Board, review committee, hearing officer or panel, ~~state-bar~~ disciplinary counsel, special district counsel, Association staff, staff and peer counselors of the Lawyers' Assistance Program, or any other individual acting under authority of these rules, are absolutely privileged, and no lawsuit predicated thereon may be instituted against any complainant grievants, witness or other person providing information.

**RULE 12.12  
COMPUTATION OF TIME**

In computing any period of time under these rules the provisions of CR 6 (a) and (e) shall apply.

**RULE 12.13  
STIPULATION TO EXTENSION OF TIME**

In any proceeding under these rules, except matters pending before the Supreme Court, the respondent lawyer and ~~state bar~~ disciplinary counsel may stipulate to extension of the time requirements provided herein, except the time within which any notice of appeal must be filed.

**RULE 12.14  
PRIORITIES**

Guidelines may be established by the Board of Governors or the Disciplinary Board providing for the priority under which investigations or proceedings will be processed, with first priority being given to those allegations or charges which appear to represent the most immediate threat of harm to the public.

**RULE 12.15  
DEFINITIONS**

Unless the context clearly indicates otherwise, terms used in these rules shall have the following meaning:

- (a) "Association" shall mean the Washington State Bar Association.
- (b) "Bar file" shall mean the pleadings, motions, rulings, decisions, and other formal papers filed in a proceeding beginning with the formal complaint.
- (c) "Board" when used alone in these rules shall mean the Disciplinary Board.
- (d) "Panel" shall mean a hearing panel.

**RULE 12.16  
EFFECT ON PENDING PROCEEDINGS**

Upon the effective date of these rules as ordered by the Supreme Court they shall apply in their entirety to any matter or investigation which is pending and which has not yet been ordered to hearing or ordered dismissed. They shall apply to other pending matters insofar as practicable. The hearing officer or panel chairperson appointed to hear a matter, or the chairperson of the Board in a matter pending before the Board, shall rule on questions concerning the appropriate procedure to be followed with a view to insuring a fair and orderly proceeding.

**RULE 12.17  
LAWYERS' ASSISTANCE PROGRAM;  
CONFIDENTIALITY**

Confidential communications between a lawyer and staff or peer counselors of the Lawyers' Assistance Program shall be privileged against disclosure without the consent of the client to the same extent and subject to the same conditions as confidential communications between a client and psychologist.

**TITLE 13  
AUDITS AND TRUST ACCOUNT OVERDRAFT  
NOTIFICATION**

**RULE 13.1  
AUDIT AND INVESTIGATION OF BOOKS AND  
RECORDS**

The Board and its chairperson shall have the following authority to examine, investigate and audit the books and records of any lawyer for the purpose of ascertaining and reporting whether RPC 1.14 has been or is being complied with by such lawyer:

(a) Random Examination. The Board may from time to time authorize examinations of the books and records of any lawyer or firm of lawyers selected at random. Such examinations shall extend only to the books and records of such lawyer or firm of lawyers.

(b) Particular Examination. The chairperson of the Board may, upon receipt of information that a particular lawyer or firm of lawyers may not be in compliance with RPC 1.14, authorize an examination limited to the scope set forth in section (a). Such information may be presented to the chairperson without notice to the lawyer or firm of lawyers.

(c) Audit. Upon the examination set forth in section (a) or (b), if the chairperson of the Board shall determine that further examination is warranted, the chairperson may then order an appropriate audit of the lawyer's or the firm's books and records, including verification of the information therein from available sources.

**RULE 13.2  
COOPERATION OF LAWYER**

It shall be the duty and obligation of any lawyer or firm who is subject to examination, investigation and audit under rule 13.1 to cooperate with the person conducting the examination, investigation or audit, subject only to the proper exercise of any privilege against self-incrimination where applicable, by:

(a) Producing to such person forthwith all evidence, books, records and papers as such person shall request for the purpose of his or her examination, investigation or audit;

(b) Furnishing forthwith such explanations as the person may require for the purpose of his or her examination, investigation or audit;

(c) Producing, in those cases where the examination, investigation or audit is being conducted pursuant to rule 13.1, to such person forthwith written authorization, directed to any bank or depository, for the person to examine, investigate or audit trust and general accounts, safe deposit boxes and other forms of maintaining trust property by the lawyer in such bank or depository.

**RULE 13.3  
DISCLOSURE**

The examination and audit report shall be open to the Board, ~~state bar~~ disciplinary counsel, the lawyer or firm examined, investigated or audited, and to the Board of

Governors upon its request, unless a disciplinary proceeding is commenced in which event the disclosure provisions of Title 11 shall apply.

#### RULE 13.4

##### TRUST ACCOUNT OVERDRAFT NOTIFICATION

(a) **Overdraft Notification Agreement Required.** Every bank, credit union, savings and loan association or qualified public depository referred to in RPC 1.14(c) shall be approved as a depository for lawyer trust accounts if it shall file with the Disciplinary Board an agreement, in a form provided by the Board, to report to the Board in the event any properly payable instrument is presented against a lawyer trust account containing insufficient funds, whether or not the instrument is honored. Any such agreement shall apply to all branches of the financial institution and shall not be canceled except upon 30 days' notice in writing to the Board. The Board shall annually publish a list of approved financial institutions.

(b) **Overdraft Reports.** The overdraft notification agreement shall provide that all reports made by the financial institution shall contain the following information:

- (1) The identity of the financial institution;
- (2) The identity of the lawyer or law firm;
- (3) The account number;
- (4) Either (i) the amount of overdraft and date created; or (ii) the amount of the returned instrument(s) and the date returned. The information required by the notification agreement shall be provided within 5 banking days of the date the item(s) was paid or returned unpaid.

(c) **Costs.** Nothing herein shall preclude a financial institution from charging a particular lawyer or law firm for the reasonable cost of producing the reports and records required by this rule, but such charges shall not be a transaction cost to be charged against funds payable to the Legal Foundation of Washington pursuant to RPC 1.14 (c)(1).

(d) **Notification by Lawyer.** Every lawyer who receives notification that any instrument presented against his or her trust account was presented against insufficient funds, whether or not the instrument was honored, shall promptly notify the Office of Disciplinary Counsel of the Association of the same information required by section (b). The lawyer shall include a full explanation of the cause of the overdraft.

#### RULE 13.5

##### DECLARATION OR QUESTIONNAIRE

(a) **Questionnaire.** The Association shall cause to be directed annually to each active lawyer a written declaration or questionnaire designed to determine whether such lawyer is complying with RPC 1.14. Such declaration or questionnaire shall be completed, executed and delivered by such lawyer to the Association on or before the date of delivery specified in such declaration or questionnaire.

(b) **Noncompliance.** Failure to file the declaration or questionnaire on or before the date specified in section (a) shall be grounds for discipline. Such failure shall

also subject the lawyer who has failed to comply with this rule to a full audit of his or her books and records as provided in rule 13.1(c), upon request of ~~state bar~~ disciplinary counsel to a review committee. A copy of any request made under this section shall be served upon the lawyer involved. The request shall be granted upon a showing that the lawyer has failed to comply with section (a) of this rule. If the lawyer should later comply, ~~state bar~~ disciplinary counsel shall have discretion to determine whether an audit should be conducted, and if so the scope of that audit. A lawyer audited pursuant to this section shall be liable for all actual costs of conducting such audit, and also a charge of \$100 per day spent by the auditor in conducting the audit and preparing an audit report. Costs and charges shall be assessed in the same manner as costs under rule 2.8 (b)(2).

#### RULE 13.6

##### REGULATIONS

The Disciplinary Board may adopt regulations pertinent to the powers set forth in this rule subject to the approval of the Board of Governors and the Supreme Court.

#### ER 104 (c),(d)

(c) **Hearing of Jury.** Hearings on the admissibility of confessions shall in all cases be conducted out of the hearing of the jury. Hearings on other preliminary matters shall be so conducted when the interests of justice require or, when an accused is a witness, ~~if he~~ and so requests.

(d) **Testimony by Accused.** The accused does not, by testifying upon a preliminary matter, become subject ~~himself~~ to cross examination as to other issues in the case.

#### ER 404

##### CHARACTER EVIDENCE NOT ADMISSIBLE TO PROVE CONDUCT; EXCEPTIONS; OTHER CRIMES

(a) **Character Evidence Generally.** Evidence of a person's character or a trait of ~~his~~ character is not admissible for the purpose of proving ~~that he acted~~ action in conformity therewith on a particular occasion, except:

(1) **Character of Accused.** Evidence of a pertinent trait of ~~his~~ character offered by an accused, or by the prosecution to rebut the same;

(2) **Character of Victim.** Evidence of a pertinent trait of character of the victim of the crime offered by an accused, or by the prosecution to rebut the same, or evidence of a character trait of peacefulness of the victim offered by the prosecution in a homicide case to rebut evidence that the victim was the first aggressor;

(3) **Character of Witness.** Evidence of the character of a witness, as provided in rules 607, 608, and 609.

(b) **Other Crimes, Wrongs, or Acts.** Evidence of other crimes, wrongs, or acts is not admissible to prove the character of a person in order to show ~~that he acted~~ action in conformity therewith. It may, however, be admissible for other purposes, such as proof of motive, opportunity, intent, preparation, plan, knowledge, identity, or absence of mistake or accident.



## ER 405(b)

(b) Specific Instances of Conduct. In cases in which character or a trait of character of a person is an essential element of a charge, claim, or defense, proof may also be made of specific instances of his that person's conduct.

## ER 411

## LIABILITY INSURANCE

Evidence that a person was or was not insured against liability is not admissible upon the issue whether ~~he~~ the person acted negligently or otherwise wrongfully. This rule does not require the exclusion of evidence of insurance against liability when offered for another purpose, such as proof of agency, ownership, or control, or bias or prejudice of a witness.

## ER 412

SEXUAL OFFENSES-VICTIM'S PAST BEHAVIOR  
[Reserved. See RCW 9A.44.020.]

## Comment 412

[1988 Amendment]

In Washington, the admissibility of evidence of a sexual offense victim's past sexual behavior is covered by statute. RCW 9A.44.020, similar in approach to Federal Rule 412, provides that in any prosecution for rape, or for an attempt or assault with intent to commit such crime, evidence of the victim's past sexual behavior is inadmissible on the issue of credibility and may only be admitted on the issue of consent pursuant to the procedures prescribed in the statute.

Inclusion of a reserved ER 412 was intended to remind users of the rules to refer to the statute for guidance. It also recognized the Washington Supreme Court's continuing rulemaking authority in this area (as the statute covers a subject within the court's purview) and thus preserved the court's flexibility should it decide at some future time to adopt a rule relating to victim's past sexual conduct.

## ER 501

## GENERAL RULE

~~By way of illustration, and not by way of limitation, the following are examples of privileges recognized in this state. The following citations are to certain statutes and case law that make reference to privileges or privileged communications. This list is not intended to create any privilege, nor to abrogate any privilege by implication or omission.~~

(a) Attorney-Client. [Reserved. See RCW 5.60.060(2).]

(b) Clergyman or Priest. [Reserved. See RCW 5.60.060(3), 26.44.060, 70.124.060.]

(c) Dispute Resolution Center. [Reserved. See RCW 7.75.050.]

(d) ~~Grand Juror Counselor.~~ [Reserved. See RCW ~~10-27.090~~ 18.19.180.]

(e) Higher Education Procedures. [Reserved. See RCW 28B.19.120(4).]

(f) Husband-Wife. [Reserved. See RCW 5.60.060(1), 26.20.071, 26.21.170.]

(g) Interpreter in Legal Proceeding. [Reserved. See RCW 2.42.160; GR 11.1(e).]

(h) Journalist. [Reserved. See *Seneary v. Daily Journal-American*, 97 Wn.2d 148, 641 P.2d 1180 (1982); *State v. Rinaldo*, 102 Wn.2d 749, 689 P.2d 392 (1984).]

(i) Optometrist-Patient. [Reserved. See RCW 18.53-.200, 26.44.060.]

(j) Physician-Patient. [Reserved. See RCW 5.60.060(4), 26.26.120, 26.44.060, 51.04.050, 69.41.020, 69.50.403, ~~69.54.070~~, 70.124.060, 71.05.250.]

(k) Psychologist-Client. [Reserved. See RCW 18.83-.110, 26.44.060, 70.124.060.]

(l) Public Assistance Recipient. [Reserved. See RCW 74.04.060.]

(m) Public Officer. [Reserved. See RCW 5.60.060(5).]

(n) Registered Nurse. [Reserved. See RCW 5.62.010, 5.62.020, 5.62.030.]

## Comment 501

[1988 Amendment]

This rule was initially left reserved. The 1988 amendment added references to statutory privileges for the guidance and convenience of both judges and practitioners.

Only the name of the privilege was given, with the text reserved and a statutory reference provided. The qualified journalist's privilege, though found in case law and based on common law rather than the constitution, was included as well. The amendment allowed ready reference to the more common privileges by the bench and bar without eliminating a less often used privilege by accidental omission from the list.

## ER 601

## GENERAL RULE OF COMPETENCY

Every person is competent to be a witness except as otherwise provided by statute or by court rule.

## Comment 601

[1991 Supplement to Comment]

The second paragraph of the original comment referred to RCW 5.60.050 as specifying among those who are incompetent to testify "[c]hildren under ten years of age, who appear incapable of receiving just impressions of the facts, respecting which they are examined, or of relating them truly." A 1986 amendment to RCW 5.60.050(2) eliminated the age limitation. The statute now reads "[t]hose who appear incapable of receiving just impressions. . .".

## ER 602

## LACK OF PERSONAL KNOWLEDGE

A witness may not testify to a matter unless evidence is introduced sufficient to support a finding that ~~he~~ the witness has personal knowledge of the matter. Evidence to prove personal knowledge may, but need not, consist of the witness' own testimony ~~of the witness himself~~. This rule is subject to the provisions of rule 703, relating to opinion testimony by expert witnesses.



ER 603  
OATH OR AFFIRMATION

Before testifying, every witness shall be required to declare that ~~he~~ the witness will testify truthfully, by oath or affirmation administered in a form calculated to awaken ~~his~~ the witness' conscience and impress ~~his~~ the witness' mind with ~~his~~ the duty to do so.

ER 604  
INTERPRETERS

An interpreter is subject to the provisions of these rules relating to qualification as an expert and the administration of an oath or affirmation ~~that he will~~ to make a true translation.

Comment 604  
[1991 Supplement to Comment]

Legislation adopted in 1989 modified existing statutes governing the appointment of interpreters. Further amendments adopted in 1990 recodified portions of RCW 2.42 into a new chapter 2.43. Practitioners should also be aware of General Rule 11.1, adopted in 1989, which sets forth a code of conduct for interpreters.

ER 606  
COMPETENCY OF JUROR AS WITNESS

A member of the jury may not testify as a witness before that jury in the trial of the case in which ~~he~~ the juror is sitting ~~as a juror~~. If ~~he~~ the juror is called so to testify, the opposing party shall be afforded an opportunity to object out of the presence of the jury.

ER 607  
WHO MAY IMPEACH

The credibility of a witness may be attacked by any party, including the party calling ~~him~~ the witness.

ER 608(b)

(b) Specific Instances of Conduct. Specific instances of the conduct of a witness, for the purpose of attacking or supporting ~~his~~ the witness' credibility, other than conviction of crime as provided in rule 609, may not be proved by extrinsic evidence. They may, however, in the discretion of the court, if probative of truthfulness or untruthfulness, be inquired into on cross examination of the witness (1) concerning ~~his~~ the witness' character for truthfulness or untruthfulness, or (2) concerning the character for truthfulness or untruthfulness of another witness as to which character the witness being cross-examined has testified.

ER 609(a)

(a) General Rule. For the purpose of attacking the credibility of a witness in a criminal or civil case, evidence that the witness has been convicted of a crime shall be admitted if elicited from the witness or established by public record during examination of the witness but only if the crime (1) was punishable by death or imprisonment in excess of 1 year under the law under which the witness was convicted, and the court determines that the probative value of admitting this evidence outweighs the prejudice to the party against whom the

evidence is offered, or (2) involved dishonesty or false statement, regardless of the punishment.

Comment 609  
[1988 Amendment]

[Section (a).] The 1988 amendment eliminated an ambiguity in the general rule governing impeachment by evidence of a prior conviction. Limitations on the use of felony convictions for impeachment, which under the earlier language of the rule appeared to apply only to criminal defendants or witnesses testifying on behalf of such defendants, were made applicable to all witnesses in both civil and criminal cases.

The drafters concluded that prior convictions for felonies not involving dishonesty or false statement can be highly prejudicial and that the restrictive test set forth in rule 609 (a)(1) should apply evenhandedly to all witnesses in any kind of case to which these rules apply.

ER 610  
RELIGIOUS BELIEFS OR OPINIONS

Evidence of the beliefs or opinions of a witness on matters of religion is not admissible for the purpose of showing that by reason of their nature ~~his~~ the witness' credibility is impaired or enhanced.

ER 611(c)

(c) Leading Questions. Leading questions should not be used on the direct examination of a witness except as may be necessary to develop ~~his~~ the witness' testimony. Ordinarily leading questions should be permitted on cross examination. When a party calls a hostile witness, an adverse party, or a witness identified with an adverse party, interrogation may be by leading questions.

ER 612  
WRITING USED TO REFRESH MEMORY

If a witness uses a writing to refresh his memory for the purpose of testifying, either: while testifying, or before testifying, if the court in its discretion determines it is necessary in the interests of justice, an adverse party is entitled to have the writing produced at the hearing, to inspect it, to cross-examine the witness thereon, and to introduce in evidence those portions which relate to the testimony of the witness. If it is claimed that the writing contains matters not related to the subject matter of the testimony, the court shall examine the writing in camera, excise any portions not so related, and order delivery of the remainder to the party entitled thereto. Any portion withheld over objections shall be preserved and made available to the appellate court in the event of an appeal. If a writing is not produced or delivered pursuant to order under this rule, the court shall make any order justice requires.

ER 613  
PRIOR STATEMENTS OF WITNESSES

(a) Examining Witness Concerning Prior Statement. In the examination of a witness concerning a prior statement made by ~~him~~ the witness, whether written or not, the court may require that the statement be shown or its contents disclosed to ~~him~~ the witness at that time,

and on request the same shall be shown or disclosed to opposing counsel.

(b) Extrinsic Evidence of Prior Inconsistent Statement of Witness. Extrinsic evidence of a prior inconsistent statement by a witness is not admissible unless the witness is afforded an opportunity to explain or deny the same and the opposite party is afforded an opportunity to interrogate ~~him~~ the witness thereon, or the interests of justice otherwise require. This provision does not apply to admissions of a party-opponent as defined in rule 801(d)(2).

## ER 615

## EXCLUSION OF WITNESSES

At the request of a party the court may order witnesses excluded so that they cannot hear the testimony of other witnesses, and it may make the order of its own motion. This rule does not authorize exclusion of (1) a party who is a natural person, or (2) an officer or employee of a party which is not a natural person designated as its representative by its attorney, or (3) a person whose presence is shown by a party to be reasonably necessary to the presentation of ~~his~~ the party's cause.

## ER 701

## OPINION TESTIMONY BY LAY WITNESSES

If the witness is not testifying as an expert, ~~his~~ the witness' testimony in the form of opinions or inferences is limited to those opinions or inferences which are (a) rationally based on the perception of the witness and (b) helpful to a clear understanding of ~~his~~ the witness' testimony or the determination of a fact in issue.

## ER 703

## BASES OF OPINION TESTIMONY BY EXPERTS

The facts or data in the particular case upon which an expert bases an opinion or inference may be those perceived by or made known to ~~him~~ the expert at or before the hearing. If of a type reasonably relied upon by experts in the particular field in forming opinions or inferences upon the subject, the facts or data need not be admissible in evidence.

## ER 705

DISCLOSURE OF FACTS OR DATA  
UNDERLYING  
EXPERT OPINION

The expert may testify in terms of opinion or inference and give ~~his~~ reasons therefor without prior disclosure of the underlying facts or data, unless the judge requires otherwise. The expert may in any event be required to disclose the underlying facts or data on cross examination.

## ER 706(a)

(a) Appointment. The court may on its own motion or on the motion of any party enter an order to show cause why expert witnesses should not be appointed, and may request the parties to submit nominations. The court may appoint any expert witnesses agreed upon by the parties, and may appoint witnesses of its own selection. An expert witness shall not be appointed by the court

unless ~~he~~ the witness consents to act. A witness so appointed shall be informed of ~~his~~ the witness' duties by the court in writing, a copy of which shall be filed with the clerk, or at a conference in which the parties shall have opportunity to participate. A witness so appointed shall advise the parties of ~~his~~ the witness' findings, if any; ~~his~~ the witness' deposition may be taken by any party; and ~~he~~ the witness may be called to testify by the court or any party. ~~He~~ The witness shall be subject to cross examination by each party, including a party calling ~~him~~ as a the witness.

## ER 801 (a), (d)

(a) Statement. A "statement" is (1) an oral or written assertion or (2) nonverbal conduct of a person, if it is intended by ~~him~~ the person as an assertion.

(d) Statements Which Are Not Hearsay. A statement is not hearsay if—

(1) Prior Statement by Witness. The declarant testifies at the trial or hearing and is subject to cross examination concerning the statement, and the statement is (i) inconsistent with ~~his~~ the declarant's testimony, and was given under oath subject to the penalty of perjury at a trial, hearing, or other proceeding, or in a deposition, or (ii) consistent with ~~his~~ the declarant's testimony and is offered to rebut an express or implied charge against ~~him~~ the declarant of recent fabrication or improper influence or motive, or (iii) one of identification of a person made after perceiving ~~him~~ the person; or

(2) Admission by Party-Opponent. The statement is offered against a party and is (i) ~~his~~ the party's own statement, in either ~~his~~ an individual or a representative capacity or (ii) a statement of which ~~he~~ the party has manifested ~~his~~ an adoption or belief in its truth, or (iii) a statement by a person authorized by ~~him~~ the party to make a statement concerning the subject, or (iv) a statement by ~~his~~ the party's agent or servant acting within the scope of ~~his~~ the authority to make the statement for the party, or (v) a statement by a coconspirator of a party during the course and in furtherance of the conspiracy.

## ER 803(a)

(a) Specific Exceptions. The following are not excluded by the hearsay rule, even though the declarant is available as a witness:

(1) Present Sense Impression. A statement describing or explaining an event or condition made while the declarant was perceiving the event or condition, or immediately thereafter.

(2) Excited Utterance. A statement relating to a startling event or condition made while the declarant was under the stress of excitement caused by the event or condition.

(3) Then Existing Mental, Emotional, or Physical Condition. A statement of the declarant's then existing state of mind, emotion, sensation, or physical condition (such as intent, plan, motive, design, mental feeling, pain, and bodily health), but not including a statement of memory or belief to prove the fact remembered or

believed unless it relates to the execution, revocation, identification, or terms of declarant's will.

(4) Statements for Purposes of Medical Diagnosis or Treatment. Statements made for purposes of medical diagnosis or treatment and describing medical history, or past or present symptoms, pain, or sensations, or the inception or general character of the cause or external source thereof insofar as reasonably pertinent to diagnosis or treatment.

(5) Recorded Recollection. A memorandum or record concerning a matter about which a witness once had knowledge but now has insufficient recollection to enable him the witness to testify fully and accurately, shown to have been made or adopted by the witness when the matter was fresh in his the witness' memory and to reflect that knowledge correctly. If admitted, the memorandum or record may be read into evidence but may not itself be received as an exhibit unless offered by an adverse party.

(6) Records of Regularly Conducted Activity. [Reserved. See RCW 5.45.]

(7) Absence of Entry in Records Kept in Accordance With RCW 5.45. Evidence that a matter is not included in the memoranda, reports, records, or data compilations, in any form, kept in accordance with the provisions of RCW 5.45, to prove the nonoccurrence or nonexistence of the matter, if the matter was of a kind of which a memorandum, report, record, or data compilation was regularly made and preserved, unless the sources of information or other circumstances indicate lack of trustworthiness.

(8) Public Records and Reports. [Reserved. See RCW 5.44.040.]

(9) Records of Vital Statistics. Records or data compilations, in any form, of births, fetal deaths, deaths, or marriages, if the report thereof was made to a public office pursuant to requirements of law.

(10) Absence of Public Record or Entry. To prove the absence of a record, report, statement, or data compilation, in any form, or the nonoccurrence or nonexistence of a matter of which a record, report, statement, or data compilation, in any form, was regularly made and preserved by a public office or agency, evidence in the form of a certification in accordance with rule 902, or testimony, that diligent search failed to disclose the record, report, statement, or data compilation, or entry.

(11) Records of Religious Organizations. Statements of births, marriages, divorces, deaths, legitimacy, ancestry, relationship by blood or marriage, or other similar facts of personal or family history, contained in a regularly kept record of a religious organization.

(12) Marriage, Baptismal, and Similar Certificates. Statements of fact contained in a certificate that the maker performed a marriage or other ceremony or administered a sacrament, made by a clergyman, public official, or other person authorized by the rules or practices of a religious organization or by law to perform the act certified, and purporting to have been issued at the time of the act or within a reasonable time thereafter.

(13) Family Records. Statements of fact concerning personal or family history contained in family Bibles, genealogies, charts, engravings on rings, inscriptions on

family portraits, tattoos, engravings on urns, crypts, or tombstones, or the like.

(14) Records of Documents Affecting an Interest in Property. The record of a document purporting to establish or affect an interest in property, as proof of the content of the original recorded document and its execution and delivery by each person by whom it purports to have been executed, if the record is a record of a public office and an applicable statute authorized the recording of documents of that kind in that office.

(15) Statements in Documents Affecting an Interest in Property. A statement contained in a document purporting to establish or affect an interest in property if the matter stated was relevant to the purpose of the document unless dealings with the property since the document was made have been inconsistent with the truth of the statement or the purport of the document.

(16) Statements in Ancient Documents. Statements in a document in existence 20 years or more whose authenticity is established.

(17) Market Reports, Commercial Publications. Market quotations, tabulations, lists, directories, or other published compilations, generally used and relied upon by the public or by persons in particular occupations.

(18) Learned Treatises. To the extent called to the attention of an expert witness upon cross examination or relied upon by him the expert witness in direct examination, statements contained in published treatises, periodicals, or pamphlets on a subject of history, medicine, or other science or art, established as a reliable authority by the testimony or admission of the witness or by other expert testimony or by judicial notice. If admitted, the statements may be read into evidence but may not be received as exhibits.

(19) Reputation Concerning Personal or Family History. Reputation among members of his a person's family by blood, adoption, or marriage, or among his a person's associates, or in the community, concerning a person's birth, adoption, marriage, divorce, death, legitimacy, relationship by blood, adoption, or marriage, ancestry, or other similar fact of his a person's personal or family history.

(20) Reputation Concerning Boundaries or General History. Reputation in a community, arising before the controversy, as to boundaries of or customs affecting lands in the community, and reputation as to events of general history important to the community or state or nation in which located.

(21) Reputation as to Character. Reputation of a person's character among his associates or in the community.

(22) Judgment of Previous Conviction. Evidence of a final judgment, entered after a trial or upon a plea of guilty (but not upon a plea of nolo contendere), adjudging a person guilty of a crime punishable by death or imprisonment in excess of 1 year, to prove any fact essential to sustain the judgment, but not including, when offered by the prosecution in a criminal case for purposes other than impeachment, judgments against persons other than the accused. The pendency of an appeal may be shown but does not affect admissibility.

(23) Judgment as to Personal, Family, or General History, or Boundaries. Judgments as proof of matters of personal, family, or general history, or boundaries, essential to the judgment, if the same would be provable by evidence of reputation.

ER 804  
HEARSAY EXCEPTIONS; DECLARANT  
UNAVAILABLE

(a) Definition of Unavailability. "Unavailability as a witness" includes situations in which the declarant:

(1) Is exempted by ruling of the court on the ground of privilege from testifying concerning the subject matter of his the declarant's statement; or

(2) Persists in refusing to testify concerning the subject matter of his the declarant's statement despite an order of the court to do so; or

(3) Testifies to a lack of memory of the subject matter of his the declarant's statement; or

(4) Is unable to be present or to testify at the hearing because of death or then existing physical or mental illness or infirmity; or

(5) Is absent from the hearing and the proponent of his the statement has been unable to procure his the declarant's attendance (or in the case of a hearsay exception under subsection (b)(2), (3), or (4), his the declarant's attendance or testimony) by process or other reasonable means.

(6) A declarant is not unavailable as a witness if his the exemption, refusal, claim of lack of memory, inability, or absence is due to the procurement or wrongdoing of the proponent of his a statement for the purpose of preventing the witness from attending or testifying.

(b) Hearsay Exceptions. The following are not excluded by the hearsay rule if the declarant is unavailable as a witness:

(1) Former Testimony. Testimony given as a witness at another hearing of the same or a different proceeding, or in a deposition taken in compliance with law in the course of the same or another proceeding, if the party against whom the testimony is now offered, or, in a civil action or proceeding, a predecessor in interest, had an opportunity and similar motive to develop the testimony by direct, cross, or redirect examination.

(2) Statement Under Belief of Impending Death. In a trial for homicide or in a civil action or proceeding, a statement made by a declarant while believing that his the declarant's death was imminent, concerning the cause or circumstances of what he the declarant believed to be his the declarant's impending death.

(3) Statement Against Interest. A statement which was at the time of its making so far contrary to the declarant's pecuniary or proprietary interest, or so far tended to subject him the declarant to civil or criminal liability, or to render invalid a claim by him the declarant against another, that a reasonable man person in his the declarant's position would not have made the statement unless he the person believed it to be true. A In a

criminal case, a statement tending to expose the declarant to criminal liability and ~~offered to exculpate the accused~~ is not admissible unless corroborating circumstances clearly indicate the trustworthiness of the statement.

(4) Statement of Personal or Family History. (i) A statement concerning the declarant's own birth, adoption, marriage, divorce, legitimacy, relationship by blood, adoption, or marriage, ancestry, or other similar fact of personal or family history, even though declarant had no means of acquiring personal knowledge of the matter stated; or (ii) a statement concerning the foregoing matters, and death also, of another person, if the declarant was related to the other by blood, adoption, or marriage or was so intimately associated with the other's family as to be likely to have accurate information concerning the matter declared.

(5) Other Exceptions. [Reserved.]

ER 806  
ATTACKING AND SUPPORTING CREDIBILITY  
OF DECLARANT

When a hearsay statement, or a statement defined in rule 801 (d)(2)(iii), (iv), or (v), has been admitted in evidence, the credibility of the declarant may be attacked, and if attacked may be supported, by any evidence which would be admissible for those purposes if declarant had testified as a witness. Evidence of a statement or conduct by the declarant at any time, inconsistent with his the declarant's hearsay statement, is not subject to any requirement that he the declarant may have been afforded an opportunity to deny or explain. If the party against whom a hearsay statement has been admitted calls the declarant as a witness, the party is entitled to examine him the declarant on the statement as if under cross examination.

ER 807  
CHILD VICTIMS OR WITNESSES  
[Reserved. See RCW 9A.44.120.]

Comment 807  
[1988 Amendment]

Though not covered by the federal rules, hearsay statements made by a child victim or witness were the subject of a recent addition to the Uniform Rules of Evidence. In Washington, these statements are governed by RCW 9A.44.120, which allows a statement made by a child under the age of 10 describing sexual contact to be admissible in dependency and criminal proceedings under certain circumstances.

While the Washington statute is limited to statements describing "any act of sexual contact performed with or on the child by another, not otherwise admissible by statute or court rule," the Uniform Rule covers statements that describe "an act of sexual conduct or physical violence. . .". The drafters of ER 807 elected to reserve the rule and refer to the statute, rather than supersede it by adopting the Uniform Rule.

The reserved rule again recognized that the admissibility of a child's statement is a proper area for the Washington Supreme Court's rulemaking authority.

## ER 902 (b), (c), (d)

Extrinsic evidence of authenticity as a condition precedent to admissibility is not required with respect to the following:

(b) Domestic Public Documents Not Under Seal. A document purporting to bear the signature in his the official capacity of an officer or employee of any entity included in section (a), having no seal, if a public officer having a seal and having official duties in the district or political subdivision of the officer or employee certifies under seal that the signer has the official capacity and that the signature is genuine.

(c) Foreign Public Documents. A document purporting to be executed or attested in his an official capacity by a person authorized by the laws of a foreign country to make the execution or attestation, and accompanied by a final certification as to the genuineness of the signature and official position (1) of the executing or attesting person, or (2) of any foreign official whose certificate of genuineness of signature and official position relates to the execution or attestation or is in a chain of certificates of genuineness of signature and official position relating to the execution or attestation. A final certification may be made by a secretary of embassy or legation, consul general, consul, vice-consul, or consular agent of the United States, or a diplomatic or consular official of the foreign country assigned or accredited to the United States. If reasonable opportunity has been given to all parties to investigate the authenticity and accuracy of official documents, the court may, for good cause shown, order that they be treated as presumptively authentic without final certification or permit them to be evidenced by an attested summary with or without final certification.

(d) Certified Copies of Public Records. A copy of an official record or report or entry therein, or of a document authorized by law to be recorded or filed and actually recorded or filed in a public office, including data compilations in any form, certified as correct by the custodian or other person authorized to make the certification, by certificate complying with section (a), (b), or (c) of this rule or complying with any applicable law, treaty or convention of the United States, or the applicable law of a state or territory of the United States.

Comment 902  
[1988 Amendment]

[Section (d).] The 1988 amendment removed a gap in the portion of this rule that allowed certified copies of public records to be self-authenticating. The prior rule permitted certification by compliance with "any law of the United States or of this state." The drafters agreed that "[t]he rationale underlying the notion of self-authentication is that the likelihood of fabrication or honest error is so slight in comparison with the time and expense involved in authentication that extrinsic evidence is not required. Evidence of nonauthenticity may, of course, be introduced." (Footnote omitted.) Graham, *Federal Evidence* § 902.0 (2d ed. 1986).

The amended rule expanded the certification provision to permit certification that complies with "the applicable law of a state or territory of the United States." While in most instances the "applicable law" will be that of the state from which the record originated, including of course the state of Washington, there may be exceptional circumstances where this is not the case. The amendment defers to other choice of law principles in these situations.

The second portion of the amendment, adding the language "treaty or convention" to "law of the United States," acknowledged that international agreements may affect the admissibility of evidence in a state court. For example, the recently enacted notary statute recognized foreign notarial acts by providing that "[a]n 'apostille' in the form prescribed by the Hague Convention of October 5, 1961, conclusively establishes that the signature of the notarial officer is genuine and that the officer holds the designated office." RCW 42.44.150(2). See also RCW 42.44.180. While it may be that the term "law" encompasses treaties and conventions, the drafters concluded that no room should be left for debate.

## ER 1004(c)

The original is not required, and other evidence of the contents of a writing, recording, or photograph is admissible if:

(c) Original in Possession of Opponent. At a time when an original was under the control of the party against whom offered, he that party was put on notice, by the pleadings or otherwise, that the contents would be a subject of proof at the hearing, and he that party does not produce the original at the hearing; or

## ER 1007

## TESTIMONY OR WRITTEN ADMISSION OF PARTY

Contents of writings, recordings, or photographs may be proved by the testimony or deposition of the party against whom offered or by his that party's written admission, without accounting for the nonproduction of the original.

## ER 1101 (c), (d)

(c) When Rules Need Not Be Applied. The rules (other than with respect to privileges) need not be applied in the following situations:

(1) Preliminary Questions of Fact. The determination of questions of fact preliminary to admissibility of evidence when the issue is to be determined by the court under rule 104(a).

(2) Grand Jury. Proceedings before grand juries and special inquiry judges.

(3) Miscellaneous Proceedings. Proceedings for extradition or rendition; detainer proceedings under RCW 9.100; preliminary determinations in criminal cases; sentencing, or granting or revoking probation; issuance of warrants for arrest, criminal summonses, and search warrants; proceedings with respect to release on bail or otherwise; contempt proceedings in which the court may

act summarily; habeas corpus proceedings; small claims court; supplemental proceedings under RCW 6.32; coroners' inquests; preliminary determinations in juvenile court proceedings under RCW Title 13; juvenile court hearings on declining jurisdiction under RCW 13.40-.110; disposition hearings in juvenile court; review hearings in juvenile court under RCW 13.32A.190 and RCW 13.34.130 ~~(3)(4)~~; dispositional determinations related to treatment for alcoholism, intoxication, or drug addiction under the Uniform Alcoholism and Intoxication Treatment Act; RCW 70.96A; and dispositional determinations under the Civil Commitment Act, RCW 71.05.

(d) Arbitration Hearings. In a mandatory arbitration hearing under RCW 7.06, the admissibility of evidence is governed by MAR 5.3.

Comment 1101  
[1989 Amendment]

[Section (d).] The 1989 amendment reflected a contemporaneous amendment to the Mandatory Arbitration Rules, which in turn addressed the applicability of the Rules of Evidence to mandatory arbitration hearings. A new section (d) was added to ER 1101, providing simply that the admissibility of evidence in a mandatory arbitration proceeding "is governed by MAR 5.3." The cross reference was appropriate because, under mandatory arbitration, the Rules of Evidence cannot be said clearly to apply or not to apply. Rather, the extent of their applicability is left to the determination of the arbitrator under MAR 5.3.

RAP 16.1(g)

(g) Review of Sentence. Rule 16.18 defines the procedure for reviewing a sentence committing an offender to the Department of Corrections, when an error of law is asserted by the Department.

RAP 16.18

POST-SENTENCE PETITIONS

(a) Generally. The Department of Corrections may petition the Court of Appeals for review of a sentence committing an offender to the custody or jurisdiction of the Department of Corrections. The review shall be limited to errors of law.

(b) Filing. The petition should be filed no later than 90 days after the Department of Corrections has received the documents containing the terms of the sentence. The petition should be filed in the division that includes the superior court entering the decision under review.

(c) Parties. When the Department files the petition, it should serve copies on the prosecuting attorney and on the offender whose sentence is in question. The appellate court clerk will serve the offender with a statement of the right to counsel and the right to proceed at public expense if indigent. If the offender was found indigent at trial and has been incarcerated since trial, continued indigency is presumed. In other cases where the offender

claims indigency, the Court of Appeals may make a determination of indigency or may remand to the sentencing court for such a determination. The Court of Appeals may appoint counsel for indigent offenders and waive costs as provided in RAP 16.15(g) or may remand to the sentencing court for such appointment. All parties should file a written response to the petition within 45 days after the appellate court clerk notifies the offender of the right to counsel and the right to proceed at public expense. The Department has 20 days after service of the last response to file a reply.

(d) Petition. The petition should contain:

- (1) The county and superior court cause number below;
- (2) The crime for which the offender was convicted;
- (3) The date the Department of Corrections received the documents containing the terms of the sentence;
- (4) The address of the offender;
- (5) The error of law at issue;
- (6) A statement by the Department of Corrections of all efforts that have been made to resolve the dispute at the superior court level, and the results thereof;
- (7) Argument;
- (8) The relief requested;
- (9) A conclusion; and
- (10) An appendix. The appendix should contain a copy of the judgment and sentence, the warrant of commitment, and any response of the superior court regarding the Department's administrative efforts to resolve the issue.

(e) Consideration of Petition.

(1) Generally. The Chief Judge will consider the petition promptly after the time has expired for filing of the Department's reply. The Chief Judge determines at the initial consideration if the petition will be retained by the appellate court for determination on the merits.

(2) Determination by Appellate Court. The Chief Judge determines at the initial consideration of the petition the steps necessary to properly decide on the merits the issues raised by the petition. If the issues presented are frivolous, the Chief Judge will dismiss the petition. If the petition is not frivolous, the Chief Judge will refer the petition to a panel of judges for a determination on the merits. The Chief Judge may enter other orders necessary to obtain a prompt determination of the petition on the merits.

(3) Oral Argument. Decisions of the Chief Judge will be made without oral argument. If a petition is to be decided on the merits by a panel of judges, the appellate court clerk will set the petition for consideration by the panel of judges, with or without oral argument. If oral argument is directed, the clerk will notify the parties of the date set for oral argument.

(f) Disposition. The court of Appeals will dispose of the matter in such manner as the ends of justice require.

(g) Review of Court of Appeals Decision. If the petition is dismissed by the Chief Judge or decided by the Court of Appeals on the merits, the decision is subject to review by the Supreme Court by a motion for discretionary review on the terms and in the manner provided in rule 13.5 (a), (b), and (c).

## CR 26(i)

(i) Motions; Conference of Counsel Required. The court will not entertain any motion or objection with respect to rules 26 through 37 unless counsel have conferred with respect to the motion or objection. Counsel for the moving or objecting party shall arrange for a mutually convenient conference in person or by telephone. If the court finds that counsel for any party, upon whom a motion or objection in respect to matters covered by such rules has been served, has willfully refused or failed to confer in good faith, the court may apply the sanctions provided under rule 37(b). Any motion seeking an order to compel discovery or obtain protection shall include counsel's certification that the conference requirements of this rule have been met.

## CR 37(a)

(a) Motion for Order Compelling Discovery. A party, upon reasonable notice to other parties and all persons affected thereby, and upon a showing of compliance with rule 26(i), may apply to the court in the county where the deposition was taken, or in the county where the action is pending, for an order compelling discovery as follows:

(1) Appropriate Court. An application for an order to a party may be made to the court in which the action is pending, or on matters relating to a deposition, to the court in the county where the deposition is being taken. An application for an order to a deponent who is not a party shall be made to the court in the county where the deposition is being taken.

(2) Motion. If a deponent fails to answer a question propounded or submitted under rules 30 or 31, or a corporation or other entity fails to make a designation under rule 30 (b)(6) or 31(a), or a party fails to answer an interrogatory submitted under rule 33, or if a party, in response to a request for inspection submitted under rule 34, fails to respond that inspection will be permitted as requested or fails to permit inspection as requested, any party may move for an order compelling an answer or a designation, or an order compelling inspection in accordance with the request. When taking a deposition on oral examination, the proponent of the question may complete or adjourn the examination before he applies for an order.

If the court denies the motion in whole or in part, it may make such protective order as it would have been empowered to make on a motion made pursuant to rule 26(c).

(3) Evasive or Incomplete Answer. For purposes of this section an evasive or incomplete answer is to be treated as a failure to answer.

(4) Award of Expenses of Motion. If the motion is granted, the court shall, after opportunity for hearing, require the party or deponent whose conduct necessitated the motion or the party or attorney advising such conduct or both of them to pay to the moving party the reasonable expenses incurred in obtaining the order, including attorney fees, unless the court finds that the opposition to the motion was substantially justified or that other circumstances make an award of expenses unjust.

If the motion is denied, the court shall, after opportunity for hearing, require the moving party or the attorney advising the motion or both of them to pay to the party or deponent who opposed the motion the reasonable expenses incurred in opposing the motion, including attorney fees, unless the court finds that the making of the motion was substantially justified or that other circumstances make an award of expenses unjust.

If the motion is granted in part and denied in part, the court may apportion the reasonable expenses incurred in relation to the motion among the parties and persons in a just manner.

## CR 77(h)

~~(h) Summer Recess. No cases shall be tried between the first day of July and the first day of September of each year except by order of the court or by consent of all parties and of the court. [Reserved.]~~

## APR 3(b)

(b) Qualification for Bar Examination. To qualify to sit for the bar examination, a person must present satisfactory proof of either (i) graduation from a law school approved by the Board of Governors, or (ii) completion of the law clerk program prescribed by these rules, or (iii) admission to the practice of law by examination, together with current good standing, in any state or territory of the United States or the District of Columbia or any jurisdiction where the common law of England is the basis of its jurisprudence, and active legal experience for at least 3 of the 5 years immediately preceding the filing of the application. "Active legal experience" shall mean experience either in the active practice of law, or as a teacher at an approved law school, or as a judge of a court of general or appellate jurisdiction, or any combination thereof, in a state or territory of the United States or in the District of Columbia or in any jurisdiction where the common law of England is the basis of its jurisprudence.

## APR 11

## CONTINUING LEGAL EDUCATION

## APR 11.2

## EDUCATIONAL REQUIREMENT

(a) Minimum Requirement. Each active member of the Bar Association shall complete a minimum of ±5 45 credit hours of approved or accredited legal education (as provided in rule APR 11.4) ~~during each calendar year after 1976 every 3 years, as provided in the regulations to this rule. If a member completes more than ±5 such hours 45 credits in a given calendar year after 1976; 3-year reporting period, 15 of the excess credits may be carried forward and applied to such that member's education requirement for either or both of the next 2 succeeding calendar years. Such legal education completed between September 1, 1976, and December 31, 1976, shall be credited as though it had been completed in 1977 the next reporting period.~~

(b) New Admission. ~~An attorney shall not be required to comply with this rule during the calendar year in which he or she is admitted nor for the following full calendar year. Newly admitted members shall complete~~



45 continuing legal education credits anytime during the year in which he or she is admitted or the next 4 full calendar years. If the newly admitted member earns more than 45 credits during that new admission period, 15 of the excess credits may be carried forward to the next reporting period. Following the new admission period, the member shall complete 45 credits every 3 years as required by APR 11.2(a).

APR 11.6(a)

~~(a) Compliance Report. On or before each January 31, commencing January 31, 1978, each active member shall file a report with the Bar Association in such form as the Bar Association shall prescribe concerning such member's completion of accredited legal education during the preceding calendar year. Each active member shall submit a CLE compliance report as specified in the regulations, or as approved by the Board pursuant to rule 11.4. If such a member has not completed the minimum education requirement for the preceding year that member's reporting period, compliance may still be accomplished, as specified in the regulations, by making up the deficiency within the first 4 months of the next succeeding calendar year, filing a supplemental report with the Bar Association by May 1 of such that year evidencing such compliance in such form as the Bar Association shall prescribe and by paying a special \$50 filing fee, therefor. Provided, however, that such special filing fee shall be increased by \$100 for each consecutive year in which such member shall accomplish compliance with the minimum education requirement by making up any deficiency within the next succeeding year as provided above.~~

PROPOSED AMENDMENT

Regulations to Admission to Practice Rule 11 (APR 11)

REGULATION 101. DEFINITIONS [No Change.]

REGULATION 102. CONTINUING LEGAL EDUCATION REQUIREMENT

As provided in APR 11.2(a), each active member shall complete a minimum of 45 credit hours of approved legal education every three years, during each calendar year after 1976. If an active member completes more than 45 credits during a three-year reporting period, 15 of such hours in a given calendar year after 1976 the excess credits may be carried forward and applied to that such member's education requirement for the next reporting period, either or both of the next two (2) succeeding calendar years. Such legal education completed between September 1, 1976 and December 31, 1976, shall be credited as though completed in 1977. This requirement shall be prorated during the implementation period for active members who are assigned an initial reporting period of less than three years.

(a) Implementation. All member active in 1992, except those admitted in 1991 and 1992, will be assigned to three reporting groups of approximately equal numbers. Group 1 shall have a one-year initial reporting period. Group 2 shall have a two-year initial reporting period. Group 3 shall have a three-year initial reporting

period. All subsequent reporting periods shall be three years.

(b) New Admission. Attorneys admitted in 1991, 1992 and all subsequent years report credits as specified in APR 11.2(b).

(c) Carry-Over Credits Earned Prior to January 1, 1992. Any credits earned and reported for 1991 as carry-over credits shall be claimed in the reporting period(s) covering 1992 or 1993.

(d) Carry-Over Credits Earned During the Initial Reporting Period. If, during the initial reporting period, an active member earns more credits than required during that period, 15 of the excess credits may be carried forward to the next reporting period, consistent with APR 11.2(a). The combined carry-over from credits earned prior to January 1, 1992 and the initial reporting period shall not, however, exceed 30 credits.

REGULATION 103. CREDITS; COMPUTATION

(a)-(d). [No Change.]

~~(e). An active member desiring, under APR 11.2A, to obtain credit for one or more succeeding calendar year, nor exceeding two (2) such years, for completing more than fifteen (15) hours of approved continuing legal education during any one calendar year, shall report such excess or carryover credits to the Board on or before January 31st of the year following the calendar year during which the claimed excess or carryover hours were completed. [Reserved.]~~

(f)-(g). [No Change.]

REGULATION 104. STANDARDS FOR APPROVAL [No Change.]

REGULATION 105. PROCEDURE FOR APPROVAL OF CONTINUING LEGAL EDUCATION ACTIVITIES [No Change.]

REGULATION 106. ACCREDITATION OF SPONSORING AGENCIES [No Change.]

REGULATION 107. DELEGATION [No Change.]

REGULATION 108. EXECUTIVE SECRETARY'S DETERMINATIONS AND REVIEW [No Change.]

REGULATION 109. SUBMISSION OF INFORMATION—REPORTING OF ATTENDANCE

(a) Compliance Report. Pursuant to APR 11.6(a), each active member shall, on or before January 31st of each year, commencing January 31, 1978, submit an affidavit to the Board setting forth all information required by Form No. 2, concerning such active member's completion of approved continuing legal education during the preceding calendar year. Such affidavit shall also contain a report of carryover credits, if any, as the same are delineated in Regulation 103(e). file a completed compliance report with the Board, on the form provided by the Washington State Bar Association, on the date specified on the form. A compliance report is deemed completed only if all of the requested information is provided on the report and if that information is accurate.



(b). Supplemental Report. If an active member has not completed the minimum education requirement for the preceding year, that member's reporting period, compliance may still be accomplished pursuant to APR 11.6 A., by filing the compliance report required by Regulation 109(a) showing any continuing legal education credits earned during the reporting period, and by

(1) Submitting, by January 31st of the next succeeding year, the affidavit called for by Regulation 109(a) (Form No. 2), setting forth therein the extent of the active member's compliance with the minimum education requirement and a statement of intention to make up any deficiency appearing thereon within the first four (4) months of such succeeding year, and

(2) In fact making up such the deficiency within the first four (4) months of such succeeding the next succeeding calendar year, and

(3) Filing with the Board by May 1st of such year a supplemental affidavit setting forth the information showing compliance in a format similar to the Compliance Report, required by Form No. 3, and

(4) Paying at the time of filing such the supplemental affidavit, the a special \$150.00 filing fee, called for by APR 11.6.A. The filing fee shall, however, be increased by \$300.00 for each consecutive reporting period in which a member has deficient credits.

(c). [No Change.]

REGULATION 110. - REGULATION 113 [No Change.]

REGULATION 114. REACTIVATION REINSTATEMENT OF INACTIVE MEMBERS WHO VOLUNTARILY TRANSFERRED TO INACTIVE STATUS

(a). A person desiring transfer from inactive status who transferred to inactive status while in full compliance with APR 11 and who desires reinstatement to active status must comply with the applicable By-laws and procedures of the Washington State Bar Association pertaining to such change of membership status, including the filing of an application therefor with the Board of Governors of the Bar Association in such form as is prescribed by said the Board of Governors. The Board of Governors shall determine whether such application shall be granted and compliance with APR 11 and these Regulations is only one factor pertaining to such determination.

(b). A person who has previously chosen inactive status or who has been transferred to inactive status for any reason, including noncompliance with APR 11 and the Regulations, and who thereafter wishes to assume active status, shall, before January 31st next following two (2) months after submission of application for such transfer to active status qualify to the awarding of no fewer than fifteen (15) hours of credit for attendance at approved courses and shall submit to the Board the affidavit specified in Regulation 109(a). An active member who voluntarily transfers to inactive status when he or she has not complied with APR 11 and its Regulations, must make up the deficiency and fully comply with the provisions of Regulation 109(b) and any other applicable

provisions of APR 11 and these Regulations before he or she can be reinstated as an active member.

(c) (1). Upon compliance with the immediately preceding provision of this Regulation, the Board shall notify the Board of Governors of the Bar Association that the person-in-question inactive member has satisfied the minimum continuing legal education requirements of APR 11 and these Regulations. A copy of such that notification shall be sent to the person-in-question inactive member.

(2) Once notification of compliance has been received, the inactive member may seek reinstatement pursuant to Regulation 114(a).

(d) (c). A person who has been transferred from inactive to active status by the Board of Governors shall, immediately upon such transfer, be subject to the provisions of APR 11 and these Regulations as any other active member of the Bar Association.

(d). The reinstated member shall be assigned to the reporting group which, at the time of the reinstatement, is in its first year of its current reporting period.

REGULATION 115. EXEMPTIONS REINSTATEMENT OF MEMBERS INVOLUNTARILY TRANSFERRED TO INACTIVE STATUS FOR FAILURE TO COMPLY WITH APR 11

(a). New Admission. As provided for by APR 11.2.B., an active member shall not be required to comply with the minimum continuing legal education requirement of APR 11, as implemented in these Regulations, during the calendar year in which he or she is admitted to practice nor for the following full calendar year.

EXAMPLE: Attorney A is admitted to practice in October, 1977. Attorney A is not required to comply with the minimum continuing legal education requirement of APR 11 and these Regulations during 1977 or 1978. Attorney A is subject to said requirement during 1979 and all succeeding years so long as he or she is an active member of the Washington State Bar Association.

An active member who, pursuant to APR 11.6 (b)-(f), Regulation 112 or 113, is transferred involuntarily to inactive status for failure to comply with APR 11 and its Regulations, must make up the deficiency and fully comply with the provisions of Regulation 109(b) and any other applicable provisions of APR 11 and these Regulations before he or she can be reinstated as an active member.

(b) Inactive Members. Inactive members are not required to comply with the minimum continuing legal education requirement of APR 11 and these Regulations. Once an inactive member has complied with the immediately preceding provision of this Regulation, the Board shall notify the Supreme Court that the inactive member has satisfied the requirements of APR 11 and these Regulations. A copy of that notification shall be sent to that inactive member.

(c) Once the Supreme Court has reinstated the inactive member, the reinstated member shall be subject to all provisions of APR 11 and its regulations and shall be assigned to a reporting period according to the provisions of Regulation 115(d).

(d) If reinstatement occurs during the reporting period in effect at the time of the transfer, the reinstated member retains that original reporting period. If however, reinstatement occurs after the end of the reporting period in effect at the time of the transfer, then the provisions of Regulations 114(d) apply.

REGULATION 116 - 117. [No Change.]

CrRLJ 3.2(m)

(m) Bail in Criminal Traffic Offense Cases — Mandatory Appearance. When required to reasonably assure appearance in court, bail for a person arrested for the following offenses or comparable ordinances shall be the amount listed in this rule, unless all courts of limited jurisdiction within a county have adopted a uniform local rule. The court for good cause recited in a written order may set a different amount. Forfeiture of bail shall not constitute a final disposition for the following offenses or comparable ordinances without a written order of the court showing the reasons. The order may be a simple docket entry. If the court allows forfeiture of bail, it may accept the bail as full payment including all statutory assessments.

Table with 2 columns: Description of offense and Bail amount. Includes items like 'Driving while intoxicated; physical control' (\$500), 'Driving while intoxicated—nonhighway vehicle or snowmobile' (\$500), 'Operating nonhighway vehicle or snowmobile so as to endanger human life, etc.' (\$500), 'No valid driver's license' (\$100), 'Unlawful possession or use of a driver's license' (\$100), 'Operating motor vehicle with suspended or revoked license' (\$500), 'Violating occupational license restrictions' (\$500), 'Financial responsibility suspension' (\$100), 'Transporting dangerous articles' (\$500), 'Unattended hit and run' (\$250), 'Attended hit and run' (\$500), 'Reports of repairs, concealing evidence' (\$500), 'Confidentiality of driving records' (\$500), 'Failure to obey police officer, flagman, or fire fighter' (\$250), 'Failure to cooperate with or give information to police officer' (\$100), 'Failure to stop and give information' (\$100).

(RCW 46.61.022)

Table with 2 columns: Description of offense and Amount. Includes items like 'Reckless driving (RCW 46.61.500)' (\$500), 'Racing (RCW 46.61.530)' (\$500), 'Leaving children unattended (RCW 46.61.685)' (\$250), 'Failure to respond or appear (RCW 46.64.020)' (\$250), 'Unlawful operation of motor vehicle by habitual traffic offender (RCW 46.65.090)' (\$500), 'Unfair motor vehicle business practices (RCW 46.70.170)' (\$250), 'Unlawful operation of for hire vehicles (RCW 46.72.100)' (\$250), 'Motor vehicle wreckers (RCW 46.80.170)' (\$500), 'Driving training schools (RCW 46.82.390)' (\$250).

Reviser's note: The typographical errors in the above material occurred in the copy filed by the State Supreme Court and appear in the Register pursuant to the requirements of RCW 34.08.040.

Reviser's note: The spelling errors in the above material occurred in the copy filed by the State Supreme Court and appear in the Register pursuant to the requirements of RCW 34.08.040.

Reviser's note: The brackets and enclosed material in the text of the above material occurred in the copy filed by the State Supreme Court and appear in the Register pursuant to the requirements of RCW 34.08.040.

WSR 92-14-001
EMERGENCY RULES
GROWTH PLANNING HEARINGS BOARDS
[Filed June 17, 1992, 3:18 p.m.]

Date of Adoption: June 16, 1992.

Purpose: To establish rules for practice and procedure requirements before the Growth Planning Hearings Boards and rules for compliance with the public record provisions of the Public Disclosure Act.

Statutory Authority for Adoption: RCW 36.70A.270(6).

Pursuant to RCW 34.05.350 the agency for good cause finds that immediate adoption, amendment, or repeal of a rule is necessary for the preservation of the public health, safety, or general welfare, and that observing the time requirements of notice and opportunity to comment upon adoption of a permanent rule would be contrary to the public interest.

Reasons for this Finding: Chapter 36.70A RCW establishes specific time frames from which petitions for review shall be filed. These rules must be adopted on an emergency basis since the review procedure envisioned by law cannot begin until formal rules have been adopted. Emergency adoption of rules will allow for the prompt processing of appeals.

Effective Date of Rule: Immediately.

June 17, 1992
M. Peter Philley
Member, Central
Puget Sound Board

**TITLE 242 WAC  
GROWTH PLANNING HEARINGS BOARDS**

**CHAPTER 242-02 WAC  
PRACTICE AND PROCEDURE**

**WAC**

**ADMINISTRATION**

- 242-02-010 Organization.  
242-02-020 Function.  
242-02-030 Jurisdiction.  
242-02-040 Definitions.  
242-02-050 Rules.  
242-02-052 Petition for rule making.  
242-02-054 Petition for rule making — consideration and disposition.  
242-02-060 Computation of time.  
242-02-070 Quorum.  
242-02-074 Principal offices.  
242-02-075 Regular meetings.  
242-02-080 Form and size of documents.  
242-02-090 Case number.

**PRACTICE BEFORE A BOARD**

- 242-02-110 Appearance and practice before a Board — Who may appear.  
242-02-120 Rules of professional conduct.  
242-02-130 Ex parte communication.  
242-02-140 Teleconference proceeding.

**APPEAL PROCEDURE**

- 242-02-210 Petition for review — forms — contents.  
242-02-220 Petition for review — time for filing.  
242-02-230 Notice of petition for review — service and filing.  
242-02-240 Date of filing — facsimile.  
242-02-250 Answers and petitions for cross review.  
242-02-260 Amendments to petitions for review, answers and cross petitions.  
242-02-270 Intervention.  
242-02-280 Amicus.

**SERVICE OF PAPERS**

- 242-02-310 Service of papers.  
242-02-320 Method of service.  
242-02-330 Service of papers — when complete.  
242-02-340 Proof of service — certificate.

**DISCOVERY AND SUBPOENA**

- 242-02-410 Discovery — limitation.  
242-02-420 Subpoena — issuance.  
242-02-430 Subpoena — form.  
242-02-440 Subpoena — service.  
242-02-450 Subpoena — proof of service.  
242-02-460 Subpoena — quash or modification.  
242-02-470 Subpoena — geographical scope.

**PROCEDURES PRIOR TO HEARING**

- 242-02-510 Presiding officer — powers and duties.  
242-02-520 Record.  
242-02-530 Motions — requirements.

- 242-02-532 Motions — time for filing and hearing.  
242-02-534 Response to motion.  
242-02-540 New or supplemental evidence.  
242-02-550 Prehearing conference.  
242-02-552 Prehearing conference — when held.  
242-02-554 Prehearing conference — documentary evidence.  
242-02-556 Prehearing conference — failure to supply information.  
242-02-558 Prehearing conference — agreements.  
242-02-560 Hearing — setting of time and place.  
242-02-565 Hearing — continuances.  
242-02-570 Briefs.  
242-02-580 Stipulation to the facts.  
242-02-585 Waiver of parties' appearance.

**HEARING PROCEDURE**

- 242-02-610 Hearing — testimony under oath — interpreters.  
242-02-620 Hearing — interpreters.  
242-02-630 Hearing — reporting — recording — recording devices.  
242-02-640 Hearing — procedures at hearing.  
242-02-650 Rules of evidence — admissibility criteria.  
242-02-660 Official notice — matters of law.  
242-02-670 Official notice — material facts.  
242-02-680 Hearings — board questions.

**DISPOSITION OF CASES PRIOR TO HEARING**

- 242-02-710 Failure to attend — default or dismissal — setting aside.  
242-02-720 Dismissal of actions.

**DISPOSITION OF PETITIONS FOR REVIEW  
AFTER HEARING**

- 242-02-810 Presentation of post hearing matters.  
242-02-820 Disposition of petition for review.  
242-02-830 Disposition of petition for review — final decision and order.  
242-02-840 Disposition of petition for review — initial decision and order.  
242-02-850 Disposition of initial decision — exceptions.  
242-02-860 Disposition of petition for review — finality of initial decision and order.  
242-02-870 Disposition of petition for review — final decision and order — exceptions filed.  
242-02-880 Disposition of petition for review — transcripts.  
242-02-890 Post decision hearing — determination of compliance or non-compliance with final order.

**DECLARATORY RULINGS**

- 242-02-910 Petitions for declaratory ruling.  
242-02-920 Declaratory ruling — notice to other persons.  
242-02-930 Declaratory ruling — disposition of petition.

NEW SECTION

**WAC 242-02-010 ORGANIZATION.** Three Growth Planning Hearings Boards were established pursuant to Chapter 36.70A RCW. Each board is an independent agency of the State of Washington with three members, appointed by the governor, who are qualified by experience or training in matters pertaining to land use planning. These rules were developed and adopted jointly by all three boards pursuant to RCW 36.70A.270(6).

NEW SECTION

**WAC 242-02-020 FUNCTION.** The function of a board is to make informed decisions on appeals arising from implementation of the Growth Management Act in a clear, consistent, timely and impartial manner that recognizes regional diversity.

NEW SECTION

**WAC 242-02-030 JURISDICTION.** This section is intended to be general and informational only, and failure to list matters over which a board has jurisdiction at law shall not constitute any waiver of or withdraw from such jurisdiction.

(1) Geographic jurisdiction. Each board shall hear only those matters pertaining to the cities and counties located within its jurisdictional boundaries. The boundaries are as follows:

(a) The Eastern Washington board includes all counties, and the cities now or subsequently located within these counties that are required to or choose to plan under RCW 36.70A.040 and are located east of the crest of the Cascade mountains;

(b) The Central Puget Sound board includes King, Pierce, Snohomish and Kitsap counties, and the cities now or subsequently located within those counties; and

(c) The Western Washington board includes all counties, and the cities now or subsequently located within those counties that are required to or choose to plan under RCW 36.70A.040 and are located west of the crest of the Cascade mountains and are not included in the Central Puget Sound Board boundaries;

(d) Skamania county, should it be required or choose to plan under RCW 36.70A.040 may elect to be included within the jurisdictional boundaries of the Western or Eastern Washington boards.

(2) Subject matter jurisdiction. Each board shall hear and determine petitions alleging that a state agency, county or city is not in compliance with the requirements of the act, or Chapter 43.21C RCW as it relates to plans, regulations, and amendments thereto adopted under the Act; or, petitions from cities or the governor relating to an adopted county-wide planning policy; or, that the twenty year growth management planning projections adopted by the office of financial management pursuant to RCW 43.62.035 should be adjusted.

(3) Jurisdictional Issues. Any party to a proceeding before a board may, by motion, challenge the jurisdiction of that board in any petition for review. A board may, upon its own motion, raise such an issue.

**Reviser's note:** The spelling error in the above section occurred in the copy filed by the agency and appears in the Register pursuant to the requirements of RCW 34.08.040.

NEW SECTION

**WAC 242-02-040 DEFINITIONS.** As used in this title, the following terms shall have the following meaning:

(1) "Act" means chapter 17, Laws of 1990 1st ex. sess. and chapter 32, Laws of 1991 1st sp. sess., and subsequent amendments.

(2) "Board" means the Eastern Washington, Western Washington or Central Puget Sound Growth Planning Hearings Board.

(3) "Hearing Examiner" means an authorized agent of a board who has a demonstrated knowledge of land use planning and law, appointed to assist the board in the performance of its hearing function.

(4) "Joint Boards" means the three independent boards meeting or acting jointly.

(5) "Person" means any individual, partnership, corporation, association, governmental subdivision or unit thereof, or public or private organization or entity of any character.

(6) "Petitioner" means a person, natural or otherwise, who appeals any matter to the board.

(7) "Presiding officer" means any member of a board, a hearing examiner, or any other person who is assigned to conduct a conference or hearing by a board. The presiding officer shall have authority as provided by WAC 242-02-510.

(8) "Publication" means: (a) for a city, the date the city publishes the ordinance or summary of the ordinance, adopting the comprehensive plan or development regulation or subsequent amendment, as is required to be published; (b) for a county, the date the county publishes the notice that it has adopted the comprehensive plan, development regulation or amendment thereto pursuant to RCW 36.70A.290(2).

(9) "Respondent" means a person who is named as a responding party in any petition for review before a board.

NEW SECTION

**WAC 242-02-050 RULES.** These rules shall govern the joint boards' adoption or amendment of joint rules, and all practice and procedure for hearings before a board. Where a time frame is different in these rules from those in chapter 10-08 WAC, it is because a board is required by the act to issue a final order within one hundred eighty days of filing a petition for review.

NEW SECTION

**WAC 242-02-052 PETITION FOR RULE MAKING.** (1) Right to Petition for Rule Making. Any interested person may petition the joint boards for the promulgation, amendment, or repeal of any rule. Said petition shall be filed with the Western Washington Board's office in Olympia, Washington.

(2) *Form of Petition.* The form of the petition for promulgation, amendment or repeal of any rule shall generally adhere to the following:

(a) At the top of the page shall appear the wording, "Before the Joint Growth Planning Hearings Boards." On the left side of the page below the foregoing the following caption shall be set out: "In the Matter of the Petition of (name of petitioning party) for Rule Making." Opposite the foregoing caption shall appear the word "Petition."

(b) The body of the petition shall be set out in numbered paragraphs. The first paragraph shall state the name and address of the petitioning party and whether the petitioner seeks the adoption of a new rule or rules, or amendment or repeal of an existing rule or rules. The second paragraph, in case of a proposed new rule or amendment of an existing rule, shall set forth the desired rule in its entirety. Where the petition is for repeal of an existing rule, such shall be stated and the rule proposed to be repealed shall either be set forth in full or shall be referred to by board rule number. The third paragraph shall set forth concisely the reasons for the proposal of the petitioner and shall contain a statement as to the interests of the petitioner and the subject matter of the rule. Additional numbered paragraphs may be used to give full explanation of petitioner's reason for the action sought.

(c) The petition shall be dated and signed by the person or entity named in the first paragraph or by the petitioner's attorney. The original and nine copies shall be filed with the Western Washington Board at its office in Olympia, Washington.

#### NEW SECTION

WAC 242-02-054 **PETITION FOR RULE MAKING — CONSIDERATION AND DISPOSITION.**

(1) Each petition for the adoption, amendment, or repeal of a rule shall be considered by the joint boards, and the joint boards may, in their discretion, solicit comments or invite discussion concerning the matter prior to disposition of the petition.

(2) *Consideration of Petitions.* All petitions shall be considered by the joint boards or representatives designated by each board, and the joint boards may, in their discretion, order an informal hearing or meeting for the further consideration and discussion of the requested promulgation, amendment, or repeal of any rule.

(3) *Notification of Disposition of Petition.* The joint boards or designated representatives shall notify the petitioning party within a reasonable time of the disposition, if any, of the petition.

#### NEW SECTION

WAC 242-02-060 **COMPUTATION OF TIME.**

The time within which any act shall be done, as provided by these rules, shall be computed by excluding the first date and including the last, unless the last day is a Saturday, a Sunday, or a legal holiday, and then it is excluded and the next succeeding which is neither a Saturday, a Sunday, nor a legal holiday, is included. When

the period of time prescribed or allowed is less than seven days, intermediate Saturdays, Sundays and holidays shall be excluded in the computation.

#### NEW SECTION

WAC 242-02-070 **QUORUM.** (1) *Boards.* For the purpose of adopting, amending or repealing these rules, at least two members of each board must concur.

(2) *Individual Board.* For purposes of making orders or decisions or transacting other official business, two members of each board shall constitute a quorum and may act even though one position on the board is vacant. One member or designated hearing examiner may hold hearings and take testimony. The findings of such member or hearing examiner shall not become final until approved by a majority of the board in accordance with WAC 242-02-840.

#### NEW SECTION

WAC 242-02-074 **PRINCIPAL OFFICES.** The principal offices of each board are as follows:

- (1) Eastern Washington Growth Planning Hearings Board  
1118 Larson Building  
6 South 2nd Street  
Yakima, Washington 98901  
(509) 454-7803
- (2) Western Washington Growth Planning Hearings Board  
P.O. Box 40953  
Olympia, Washington 98504-0953  
(206) 438-8760
- (3) Central Puget Sound Growth Planning Hearings Board  
600 University - Suite 2329  
Seattle, Washington 98101-1129  
(206)

#### NEW SECTION

WAC 242-02-075. **REGULAR MEETINGS.** (1) Regular meetings of each board will be held at its principal office or such other place as each board designates as follows:

- (a) Eastern Washington board - every Tuesday at 10:30 a.m..
- (b) Western Washington board - every Wednesday at 10:30 a.m..
- (c) Central Puget Sound board at 10:00 a.m. on the second Thursday of each month.

(2) The joint boards shall meet annually on the second Monday in August.

**Reviser's note:** The typographical error in the above section occurred in the copy filed by the agency and appears in the Register pursuant to the requirements of RCW 34.08.040.

#### NEW SECTION

WAC 242-02-080 **FORM AND SIZE OF DOCUMENTS.** Documents other than exhibits shall be typewritten or printed, properly captioned, signed by the appropriate authorized individual or officer submitting

the same, and shall include his or her address and telephone number. Pleadings shall be on 8 1/2 x 11 inch paper. Each board uses IBM compatible software. A board may request submission of a disk from a party, if appropriate.

**NEW SECTION**

**WAC 242-02-090 CASE NUMBER.** Each board shall assign a case number to each petition for review which shall be the official reference number for purposes of identification. The first two digits of the case number shall correspond to the last two digits of the calendar year in which the petition was filed. The third digit shall designate which board has jurisdiction over the matter. The Eastern Washington board shall use the digit "1"; the Western Washington board shall use the digit "2"; and the Central Puget Sound board shall use the digit "3". The last four digits shall be numbered sequentially in order of receipt.

**PRACTICE BEFORE A BOARD**

**NEW SECTION**

**WAC 242-02-110 APPEARANCE AND PRACTICE BEFORE A BOARD — WHO MAY APPEAR.** Practice before a board in hearings shall be open to the following:

- (1) A party to a case before the board may participate personally or, if the party is a corporation, organization, informal association or other artificial person, by a duly authorized representative;
- (2) Whether or not participating in person, any party may be advised and represented at the party's own expense by counsel or, if permitted by provision of law, other representative;
- (3) Attorneys at law practicing before the board must be duly qualified and entitled to practice in the courts of the state of Washington; or must be entitled to practice before the highest court of record of any other state, if attorneys licensed in the state of Washington are permitted to appear before the courts of such other state in a representative capacity, and if not otherwise prohibited by state law; and
- (4) Other persons permitted by law.

**NEW SECTION**

**WAC 242-02-120 RULES OF PROFESSIONAL CONDUCT.** All persons appearing in proceedings before a board in a representative capacity shall conform to the rules of professional conduct required of attorneys before the courts of Washington. If any such person does not conform to such rules, the board may decline to permit such person to appear in a representative capacity in any proceeding before that board.

**NEW SECTION**

**WAC 242-02-130 EX PARTE COMMUNICATION.** No one in a proceeding before a board shall make or attempt to make any ex parte communications

with board members, hearing examiners or presiding officers prohibited by RCW 34.05.455. A board, in conducting a formal proceeding governed by the Administrative Procedure Act, may not make or attempt to make ex parte communications prohibited by such act. Attempts by anyone to make such prohibited ex parte communications shall subject such person to the sanctions of WAC 242-02-120 and 242-02-720.

**NEW SECTION**

**WAC 242-02-140 TELECONFERENCE PROCEEDING.** (1) At the discretion of a board or a presiding officer, or where the parties agree and where the rights of the parties will not be prejudiced, all or part of any hearing, prehearing or motion hearing may be conducted by telephone, television or other electronic means. Each party in the proceeding must have an opportunity to participate effectively in, to hear, and if technically and economically feasible, to see the entire proceeding while it is taking place.

(2) The board may require documentary evidence, motions and briefing to be submitted sufficiently in advance of the teleconference proceeding to insure fair consideration and presentation of the issue. All such material shall also be served on other parties at the time of filing with a board.

**APPEAL PROCEDURE**

**NEW SECTION**

**WAC 242-02-210 PETITION FOR REVIEW — FORMS — CONTENTS.** (1) A petition for review shall substantially contain:

(a) A caption in the following form:

BEFORE THE \_\_\_\_\_ GROWTH PLANNING HEARINGS  
BOARD  
STATE OF WASHINGTON

Petitioner,

Case No.

v.

PETITION FOR REVIEW  
Re: (Type of Petition)

Respondent.

(b) Numbered paragraphs stating:

- (i) Petitioner's name, mailing address and telephone number and that of the representative, if any;
- (ii) Date of the order, determination, publication, action or failure to act from which the appeal is taken;
- (iii) A detailed statement of issues presented for resolution by the board;
- (iv) A statement indicating the basis of the petitioner's standing before the board;
- (v) The estimated length of the hearing;
- (vi) The relief sought, including the specific nature and extent;
- (vii) A statement that the petitioner has read the petition for review and believes the contents to be true, followed by the petitioner's signature and/or signature of his or her attorney or qualified representative, if any. The signature constitutes a certificate that the petition

has been read and that to the best personal knowledge, information, and belief, there is good ground to support it, and that it is not interposed for delay.

#### NEW SECTION

**WAC 242-02-220 PETITION FOR REVIEW — TIME FOR FILING.** (1) A petition relating to whether or not an adopted comprehensive plan, development regulation, or permanent amendment thereto, is in compliance with the goals and requirements of the act shall be filed with a board within sixty days after publication by the legislative body of the county or city.

(2) A petition relating to an adopted county-wide planning policy shall be filed within sixty days of its adoption.

(3) For all other matters, a petition must be filed within sixty days of the decision, order, determination, publication, action or failure to act by a specific deadline.

#### NEW SECTION

**WAC 242-02-230 PETITION FOR REVIEW — SERVICE AND FILING.** (1) The original and three copies of the petition for review shall be filed personally, by first class, certified or registered mail, by telegraph, or by electronic telefacsimile transmission with the board. A copy shall be served at the same time upon all other named parties. Proof of service may be filed if requested by a board pursuant to WAC 242-02-340.

(2) A board may dismiss a case for failure to substantially comply with subsection (1) of this section.

#### NEW SECTION

**WAC 242-02-240 DATE OF FILING — FACSIMILE.** (1) The date of filing shall be the date of actual receipt by a board at its office. The date stamp placed on the petition shall be presumptive evidence of the date of receipt.

(2) Any documents filed with the board by electronic telefacsimile transmission shall not be deemed complete unless the following procedures are strictly observed:

(a) A facsimile document will only be stamped "received" by the board between the hours of 8:00 a.m. and 5:00 p.m. excluding Saturdays, Sundays, and legal holidays. Any transmission not completed before 5:00 p.m. will be stamped received on the following business day. The date and time indicated by the board's facsimile shall be presumptive evidence of the date and time of receipt of transmission.

(b) The original document must be filed with the board within ten days from the date of transmission.

(c) All transmissions are sent at the risk of the sender.

#### NEW SECTION

**WAC 242-02-250 ANSWERS AND PETITIONS FOR CROSS REVIEW.** (1) The respondent may file an Answer to the Petition for Review. The respondent shall file the original and three copies with the board and serve a copy on the petitioner. Answers shall be filed no later than ten days prior to the prehearing conference.

Answers shall be verified in the same manner as the petition for review.

(2) A respondent may file a petition for cross review. The respondent shall file the original and three copies with the board and serve a copy on all other parties within thirty days after the service of the petition for review or any amendment to the petition. The petition for cross review shall conform in all respects to the requirements for a petition for review.

#### NEW SECTION

**WAC 242-02-260 AMENDMENTS TO PETITIONS FOR REVIEW, ANSWERS AND PETITIONS FOR CROSS REVIEW.** (1) A petition for review, answer or petition for cross review may be amended as a matter of right until thirty days after its date of filing.

(2) Thereafter any amendments shall be requested in writing as a motion, and will be made only after approval by a board or presiding officer. Amendments shall be freely granted and may be denied only upon a showing by the adverse party of unreasonable and unavoidable hardship, or unless granting the same would adversely impact a board's ability to meet the time requirements of RCW 36.70A.300 for issuing a final order. The board may, upon motion of a party or upon its own motion, require a more complete statement of the nature of the claim or defense or any other matter stated in a pleading.

#### NEW SECTION

**WAC 242-02-270 INTERVENTION.** (1) Any person whose interest may be substantially affected by a petition may request status as an intervenor in the appeal.

(2) In determining whether a petitioner qualifies as an intervenor, the presiding officer shall apply the rules of the superior courts of this state.

(3) If the petitioner qualifies for intervention, the presiding officer may impose conditions upon the intervenor's participation in proceedings, either at the time that intervention is granted or at any subsequent time. Conditions may include:

(a) Limiting the intervenor's participation to designated issues in which the intervenor has a particular interest as demonstrated by the petition;

(b) Limiting the intervenor's use of discovery, cross-examination, and other procedures so as to promote the orderly and prompt conduct of the proceedings; and

(c) Requiring two or more intervenors to combine their presentations of evidence and argument, cross-examination, discovery, and other participation in the proceedings.

(4) The presiding officer shall timely grant or deny each petition and specify conditions, if any.

#### NEW SECTION

**WAC 242-02-280 AMICUS.** (1) Any person whose interest may be substantially affected by a petition may request status as an amicus in the case.

(2) In determining whether a petitioner qualifies as an amicus, the presiding officer shall apply the rules of the court of appeals of this state.

(3) If the petitioner qualifies for amicus, the presiding officer may impose conditions upon the amicus's participation in the proceedings, either at the time that amicus is granted or at any subsequent time.

#### SERVICE OF PAPERS

##### NEW SECTION

**WAC 242-02-310 SERVICE OF PAPERS.** (1) Copies of all documents, exhibits, and papers filed with the board shall be served upon all counsel or representatives of record and upon parties not represented.

(2) Such service upon the representative shall be considered valid service for all purposes upon the party represented.

(3) Decisions or orders of the board shall be served upon the parties and their counsel or representative of record, if any.

##### NEW SECTION

**WAC 242-02-320 METHOD OF SERVICE.** Service of papers shall be made personally or by first class, registered or certified mail, by telegraph, or by facsimile transmission.

##### NEW SECTION

**WAC 242-02-330 SERVICE OF PAPERS — WHEN COMPLETE.** (1) Except as provided in subsection (2) and (3) of this section, service by mail shall be regarded as complete upon deposit in the United States mail properly stamped and addressed. Service by telegraph shall be deemed completed when deposited with a telegraph company properly addressed with the charges prepaid. Service by facsimile shall be deemed complete only when the following procedure is observed:

(a) The original document must be filed with a board within ten days from the date of transmission.

(b) Facsimile confirmation of transmission.

(c) All transmissions are sent at the risk of the sender.

(2) Papers required to be filed with a board shall be deemed filed upon actual receipt during office hours at the board's office.

(3) This section shall not extend any applicable time for appeal to the board nor extend the time for providing notice of appeal to any named party.

##### NEW SECTION

**WAC 242-02-340 PROOF OF SERVICE — CERTIFICATE.** Where proof of service is required by this chapter, by statute, or upon a board's request, filing a copy of the papers with the board together with one of the following documents shall constitute proof of service:

(1) An acknowledgement of service;

(2) A certificate that the person signing the certificate did on the date of the certificate serve the papers upon all parties of record in the proceeding by delivering a copy thereof in person to the named individuals;

(3) A certificate that the person signing the certificate did on the date of the certificate serve the papers upon all parties of record in the case by:

(a) Mailing a copy, properly addressed with postage prepaid, to each party in the case or his/her attorney or authorized agent; or

(b) Telegraphing a copy, properly addressed with charges prepaid, to each party in the case or his/her attorney or authorized agent; or

(c) Transmitting a copy by electronic telefacsimile device, and on the same day mailing a copy to each party in the case or his/her attorney or authorized agent; or

(d) Depositing a copy, properly addressed with charges prepaid, with a commercial parcel delivery company.

#### DISCOVERY AND SUBPOENA

##### NEW SECTION

**WAC 242-02-410 DISCOVERY — LIMITATION.** (1) Insofar as applicable and not in conflict with this chapter, the statutes and court rules regarding pre-trial procedures in civil cases in superior courts of the state of Washington shall be used. Such statutes and rules shall include but shall not be limited to those rules pertaining to discovery of evidence by parties to civil actions.

(2) A board or presiding officer may limit discovery upon motion by any party, or upon its own motion.

##### NEW SECTION

**WAC 242-02-420 SUBPOENA — ISSUANCE.** Subpoenas shall be issued and enforced, and witness fees paid, as provided in RCW 34.05.446. Every subpoena shall identify the party causing its issuance. Subpoenas may be issued by a board or by an attorney of record. The person issuing shall sign the subpoena. Parties desiring subpoenas to be signed by a board shall make a showing of relevance and reasonable scope of the testimony or evidence sought and shall prepare the subpoenas for issuance, send them to the board's office for signature and, upon return, shall make arrangements for service.

##### NEW SECTION

**WAC 242-02-430 SUBPOENA — FORM.** Every subpoena shall name the board and the title and number of the case and shall command the person to whom it is directed to attend and give testimony or produce designated books, documents, or things under that person's control at a specified time and place.

##### NEW SECTION

**WAC 242-02-440 SUBPOENA — SERVICE.** Service of subpoenas shall be made by delivering a copy of the subpoena to such person and tendering on demand, where the person is entitled to make a demand, the fees for one day's attendance and the mileage allowed by law. All costs, which include the cost of producing records, shall be paid by the party requesting issuance of the subpoena. A subpoena may be served by



any suitable person at least eighteen years of age, by exhibiting and reading it to the witness, or by giving him or her a copy or by leaving such copy at his or her office or place of residence.

#### NEW SECTION

**WAC 242-02-450 SUBPOENA — PROOF OF SERVICE.** Proof of service and the required return affidavit shall be filed with the board.

#### NEW SECTION

**WAC 242-02-460 SUBPOENA — QUASH OR MODIFICATION.** If the subpoena issued is unreasonable or requires evidence not relevant to any matter in issue, a board or presiding officer may quash or modify the subpoena. The person who received the subpoena must bring a motion to quash or modify at or before the time specified in the subpoena for compliance and must provide notice to the party who issued the subpoena.

#### NEW SECTION

**WAC 242-02-470 SUBPOENA — GEOGRAPHICAL SCOPE.** Attendance of witnesses and production of evidence may be required from any place in the state of Washington at any designated place of hearing.

#### PROCEDURES PRIOR TO HEARING

#### NEW SECTION

**WAC 242-02-510 PRESIDING OFFICER — POWERS AND DUTIES.** It shall be the duty of the presiding officer to conduct conferences or hearings in cases assigned in an impartial and orderly manner. The presiding officer shall have the authority, subject to the other provisions of the act or these rules: (1) To inspect the petition for review to determine whether, on its face, compliance with the jurisdictional and standing requirements of the act is shown, and if compliance is not shown, to recommend or to refer the issue to the full board for resolution;

(2) To administer oaths and affirmations;

(3) To issue subpoenas as provided in RCW 34.05.446;

(4) To rule on all procedural matters, objections and motions unless the same are required to be determined by a board;

(5) To rule on all offers of proof and receive relevant evidence;

(6) To question witnesses called by the parties in an impartial manner as needed to develop any facts deemed necessary to fairly and adequately decide the issue;

(7) To secure and present in an impartial manner such evidence, in addition to that presented by the parties, as deemed necessary to fairly and equitably decide the issue;

(8) To take appropriate disciplinary action with respect to the representatives for the parties appearing before a board;

(9) To issue orders joining other parties, on motion of any party or on his or her own motion, when it appears

that such other parties may have an interest in, or may be affected by the case;

(10) To consolidate cases for hearing when such consolidation will expedite disposition and avoid duplication of testimony and when the rights of the parties will not be prejudiced thereby;

(11) To hold conferences for the settlement or amplification of the issues;

(12) To regulate the course of the case prior to and during the hearing;

(13) To rule on issues concerning the content of the record;

(14) To waive any requirement of these rules unless a party shows that it would be prejudiced by such a waiver, and

(15) To take any other action necessary and authorized by these rules or the act.

#### NEW SECTION

**WAC 242-02-520 RECORD.** (1) Within twenty days of service of a petition for review the respondent shall file with the board a list or index of all material used in taking the action which is the subject matter of the petition of review. In addition, the written or tape-recorded record of the legislative proceedings where the action was taken shall be available to the petitioner.

(2) Within ten days of the date of filing the respondent's list or index with a board, the petitioner shall file with the board a designation of those parts of the list or index and record which are necessary for resolution of the issues presented by the petition.

(3) Within ten days of the filing of petitioner's designation, respondent or any other parties shall file a designation of additional materials which are considered necessary for a resolution of the issues.

(4) In complying with the requirements of this section, parties shall not simply designate every item but shall carefully review the list or index and record, and designate only such material as is reasonably necessary for a full and fair determination of the issues presented. Disputes either among the parties or upon a board's own motion will be resolved at the prehearing conference.

#### NEW SECTION

**WAC 242-02-530 MOTIONS — REQUIREMENTS.** (1) A motion is an application for an order or ruling. Every motion shall be in writing, unless made during a hearing, shall state with particularity the grounds and shall set forth the relief or order sought. An original and three copies of the motion shall be filed with a board and a copy served on the opposing party/parties.

(2) All motions shall be properly captioned and signed by the party, its attorney or other representative.

(3) The motion shall specify the amount of time required for argument, whether appearance by telecommunication is requested, and the names and telephone numbers of all parties served with the motion or response.

NEW SECTION

**WAC 242-02-532 MOTIONS — TIME FOR FILING AND HEARING.** (1) Prior to Scheduled Hearing. All motions shall be filed with a board and opposing parties served no later than twenty days prior to a scheduled prehearing conference.

(2) No Prehearing Conference Scheduled. Where no prehearing conference has been scheduled at the time a motion is filed, a board in its discretion may schedule a hearing at any time upon seven days notice.

(3) After Prehearing Order. No motion may be filed after a prehearing conference without written permission of the board.

(4) A board or presiding officer, in its discretion, may schedule a hearing for argument of a motion at the time of a prehearing conference or at a separate hearing time, or may defer consideration of the motion until commencement of the hearing on the petition for review. A board may also limit argument on a motion to briefs.

NEW SECTION

**WAC 242-02-534 RESPONSE TO MOTIONS.**

(1) A response to the motion shall be filed with a board and a copy served on the opposing party/parties within ten days after the date of service, unless otherwise directed by the presiding officer.

(2) The response shall specify the amount of time required for argument, whether appearance by telecommunication is requested, and the names and telephone numbers of all parties served with the response.

NEW SECTION

**WAC 242-02-540 NEW OR SUPPLEMENTAL EVIDENCE.** A party by motion may request that a board allow such additional evidence as would be necessary or of substantial assistance to the board in reaching its decision, and shall state its reasons. A board may at any time prior to, during, or after the hearing order that new or supplemental evidence be provided.

NEW SECTION

**WAC 242-02-550 PREHEARING CONFERENCE.** The purpose of a prehearing conference is to: (1) Determine the feasibility of and encourage settlement of the matter or any portion thereof;

(2) Obtain a stipulation of facts to show a board's jurisdiction and the party's standing in the matter;

(3) Obtain agreement as to the issues of law and fact presented and their simplification, limitation, or resolution;

(4) Determine the possibility of obtaining admissions of fact and authenticity of documents which will avoid unnecessary proof;

(5) Determine the admissibility of exhibits;

(6) Determine the qualifications of expert witnesses;

(7) Present any motions concerning qualification of individual board members to hear the matter;

(8) Obtain stipulation as to all or a part of the facts or documents involved in the case;

(9) Obtain information as to the number of expert and/or lay witnesses expected to be called by the parties and their names, addresses and telephone numbers, if the board has previously authorized supplemental or additional evidence to be presented at the hearing;

(10) Determine the approximate time necessary for the presentation of evidence and/or argument of the respective parties; and

(11) Obtain all other information which may aid in the prompt disposition of the matter.

NEW SECTION

**WAC 242-02-552 PREHEARING CONFERENCE — WHEN HELD.** (1) A board or presiding officer may order a prehearing conference on not less than seven days notice mailed to each party at a time and place fixed by a board.

(2) At any time prior to a hearing on a petition for review, any party may file a written application with a board requesting a prehearing conference.

NEW SECTION

**WAC 242-02-554 PREHEARING CONFERENCE — DOCUMENTARY EVIDENCE.** (1) All rulings upon objections to the admissibility of evidence shall be made in accordance with the provisions of the Administrative Procedure Act.

(2) Where practicable, the presiding officer may order:

(a) That all documentary evidence which is to be offered during the hearing be submitted to the board and to other parties sufficiently in advance to permit study and preparation of cross examination and rebuttal evidence.

(b) That documentary evidence not submitted as required in (a) of this subsection not be received in evidence in the absence of a clear showing that the offering party had good cause for the failure to produce the evidence sooner, unless it is submitted for impeachment purposes.

(c) That the authenticity of all documents so presented and examined be deemed admitted unless written objection is filed within fourteen days after receipt. A party will be permitted to challenge such authenticity at a later time only upon a clear showing of good cause for failure to have filed such written objection.

(3) The presiding officer may limit the documentary evidence to that presented at any prehearing conference. A party may submit additional documentary evidence at the time of hearing only upon a showing of good cause.

(4) When only portions of a document are to be relied upon, the offering party shall adequately identify and prepare the pertinent excerpts and shall supply copies of such excerpts to the presiding officer and to the other parties. However, the whole of the original document shall be made available for examination and for use by all parties to the proceeding.

NEW SECTION

**WAC 242-02-556 PREHEARING CONFERENCE — FAILURE TO SUPPLY INFORMATION.**

If any party fails to supply the information reasonably necessary and required at the time of the prehearing conference, a board may limit the receipt of such party's evidence.

#### NEW SECTION

**WAC 242-02-558 PREHEARING CONFERENCE — AGREEMENTS.** At the conclusion of a prehearing conference, the presiding officer may require the parties to submit proposed prehearing orders. The presiding officer will issue an order reciting the action taken at the conference and any agreements of the parties or decisions of the presiding officer. The order may include provisions pertaining to:

- (1) Jurisdiction and standing;
- (2) Issues;
- (3) Admissions;
- (4) Witnesses;
- (5) Time and location of hearings;
- (6) Authenticity and/or admissibility of exhibits;
- (7) Qualification of witnesses;
- (8) Issues remaining;
- (9) Rulings of the board prior to the prehearing conference;
- (10) Rulings of the presiding officer; and
- (11) Any other matters that may expedite the hearing.

Any objection to such order shall be made in writing within seven days after the date the order is mailed. The order shall control subsequent proceedings unless modified for good cause by a subsequent order.

#### NEW SECTION

**WAC 242-02-560 HEARING — SETTING OF TIME AND PLACE.** (1) Within ten days of the filing of a petition for review, a board will schedule a hearing date and notify the party/parties of the date.

(2) The board will thereafter schedule a place for the hearing.

(3) A written notice of the date and location of the hearing shall thereafter be sent to all parties not less than twenty days prior to the hearing date.

(4) The notice shall identify the appeal to be heard, the names of the parties to the appeal and their representatives, if any, and shall specify the time and place of hearing. The notice shall include the information specified in RCW 34.05.434 and if the hearing is to be conducted by teleconference call the notice shall so state.

(5) The notice shall state that if a limited-English speaking or hearing impaired party or witness needs an interpreter, a qualified interpreter will be appointed and that there will be no cost to the party or witness. The notice shall include a form for a party to indicate if an interpreter is needed and identification of the primary language, or if a participant is hearing impaired.

(6) Defects in notice may be waived if the waiver is knowing and voluntary.

#### NEW SECTION

**WAC 242-02-565 HEARING — CONTINUANCES.** Because of the provisions of RCW 36.70A.300,

continuances and extensions of time will only be granted on a board's initiative or upon timely request of a party setting forth in detail the reasons for such a request and a date by which such reason will no longer apply. In the latter instance, the board will continue or extend the matter only upon a finding of good cause and in order to prevent manifest injustice.

#### NEW SECTION

**WAC 242-02-570 BRIEFS.** The original and three copies of briefs shall be filed with a board at least five business days prior to the hearing unless otherwise provided by a board or presiding officer. When briefs are filed, a copy shall also be served on all other parties. A board or presiding officer may permit or require the filing of additional briefs.

#### NEW SECTION

**WAC 242-02-580 STIPULATION TO THE FACTS.** Upon stipulation by all parties that no facts are at issue, a matter may be submitted to a board or presiding officer for its determination without additional testimony being taken. The board or presiding officer, in its discretion, may require additional testimony.

#### NEW SECTION

**WAC 242-02-585 WAIVER OF PARTIES' APPEARANCE.** Upon stipulation by all parties, a matter may be submitted to a board or presiding officer without oral argument or appearance. The board or presiding officer, in its discretion, may require appearance for oral argument.

### HEARING PROCEDURE

#### NEW SECTION

**WAC 242-02-610 HEARING — TESTIMONY UNDER OATH — INTERPRETERS.** (1) All testimony to be considered by a board or presiding officer shall be sworn, and each person shall swear or affirm that the testimony to be given shall be the truth, the whole truth, and nothing but the truth, or according to the provisions of RCW 5.28.020 through 5.28.060.

(2) Every interpreter shall, before beginning to interpret, take an oath that a true interpretation will be made to the person being examined of all the proceedings in a language or in a manner which the person understands, and that the interpreter will repeat the statements of the person being examined to the presiding officer, in the English language, to the best of the interpreter's skill and judgment.

#### NEW SECTION

**WAC 242-02-620 HEARING — INTERPRETERS.** The provisions of WAC 10-08-150 are incorporated by reference herein.

#### NEW SECTION

**WAC 242-02-630 HEARING — REPORTING — RECORDING — RECORDING DEVICES.** (1)

All hearings shall be officially recorded by manual, electronic, or other type of recording device.

(2) Photographic and recording equipment of others shall be permitted at hearings; however, the presiding officer may impose such conditions upon their use as deemed necessary to prevent disruption of the hearing, or when a statute or law limits such use.

#### NEW SECTION

WAC 242-02-640 HEARING — PROCEDURES AT HEARING. (1) Presiding Officer. All hearings shall be conducted by a presiding officer who shall conduct the hearing in an orderly manner and rule on all procedural matters, objections and motions.

(2) Order of Presentation of Evidence. The presiding officer shall determine the proper order of presentation of evidence.

(3) Opening Statements. Unless the presiding officer rules otherwise, parties may present an oral opening statement setting out briefly a statement of the basic facts and issues of the case.

(4) Objections and Motions to Strike. Objection to the admission or exclusion of evidence shall state briefly the legal ground of objection.

(5) Rulings. The presiding officer, on objection on his/her own motion, shall exclude all irrelevant or unduly repetitious evidence. All rulings upon objections to the admissibility of evidence shall be made in accordance with WAC 242-02-650.

#### NEW SECTION

WAC 242-02-650 RULES OF EVIDENCE — ADMISSIBILITY CRITERIA. (1) All relevant evidence, including hearsay evidence, is admissible if, in the opinion of the presiding officer, the offered evidence is the kind of evidence upon which reasonably prudent persons are accustomed to rely in the conduct of their affairs. The presiding officer shall exclude evidence that is excludable on constitutional or statutory grounds or on the basis of evidentiary privilege recognized in the courts of this state. The presiding officer may exclude evidence that is irrelevant, immaterial, or unduly repetitious.

(2) A board's experience, technical knowledge, competency, and specialized knowledge may be used in evaluation of evidence.

(3) If not inconsistent with subsection (1) of this section, the presiding officer may refer to, but shall not be bound by, the Washington rules of evidence.

(4) Documentary evidence may be submitted in the form of copies or excerpts, or by incorporation by reference.

#### NEW SECTION

WAC 242-02-660 OFFICIAL NOTICE — MATTERS OF LAW. A board or presiding officer may officially notice:

(1) Federal law. The Constitution, congressional acts, resolutions, records, journals, and committee reports, decisions of federal courts and administrative agencies, executive orders and proclamations, and all rules, orders and notices published in the Federal Register.

(2) State law. The Constitution of the state of Washington; decisions of the state courts; acts of the legislature, resolutions, records, journals, and committee reports; decisions of administrative agencies of the state of Washington; executive orders and proclamations by the governor, and all rules, orders, and notices filed with the code reviser.

(3) Counties and cities. Ordinances and resolutions enacted by cities, counties, or other municipal subdivisions of the state of Washington.

(4) Governmental organization. Organization, territorial limitations, officers, departments and general administration of the government of the state of Washington, the United States, the several states, federally recognized Indian tribes and foreign nations.

(5) Growth Planning Hearings board. Orders and decisions of any board.

(6) Joint boards. Rules of practice and procedure.

#### NEW SECTION

WAC 242-02-670 OFFICIAL NOTICE — MATERIAL FACTS. In the absence of conflicting evidence, a board or presiding officer, upon request made before or during a hearing, may officially notice:

(1) Board proceedings. The pendency of the issues and position of the parties therein, and the disposition of any proceeding then pending before or previously concluded by the board.

(2) Business customs. General customs and practices followed in the transaction of business.

(3) Notorious facts. Facts so generally and widely known to all well-informed persons as not to be subject to reasonable dispute or specific facts which are capable of immediate and accurate demonstration by resort to accessible sources of generally accepted authority, including, but not exclusively, facts stated in any publication authorized or permitted by law to be made by any federal or state officer, department or agency.

(4) Request or suggestion. Any party may request, or a board or presiding officer may suggest, that official notice be taken of a material fact, which shall be clearly and precisely stated orally on the record, at any pre-hearing conference or oral hearing or argument, or may make such request or suggestion by written notice.

(5) Statement. Where a decision of a board rests in whole or in part upon official notice of a material fact, such fact shall be clearly and precisely stated in such decision. In determining whether to take official notice of material facts, the presiding officer may consult any source of pertinent information, whether or not furnished by any party and whether or not admissible under the rules of evidence.

(6) Objection to taking of official notice. Any party may object to a request or a suggestion that official notice of a material fact be taken at the time the same is made.

#### NEW SECTION

WAC 242-02-680 HEARINGS — BOARD QUESTIONS. A hearing examiner or any member of a

board may, at any time during the hearing, ask clarifying questions as necessary to understand the evidence.

#### DISPOSITION OF CASES PRIOR TO HEARING

##### NEW SECTION

#### WAC 242-02-710 FAILURE TO ATTEND — DEFAULT OR DISMISSAL — SETTING ASIDE.

(1) When a party to a proceeding has, after notice, failed to attend a hearing or any other matter before a board or presiding officer, a motion for default or dismissal may be sought by any party to the case or raised by a board or presiding officer upon its own motion. Any order granting the motion shall include a statement of the grounds for the order and shall be served upon all parties to the case.

(2) Within seven days after service of the default order or dismissal under subsection (1) of this section, the party against whom the order was entered may file a written objection requesting that the order be vacated and stating the specific grounds relied upon. The board may, for good cause, set aside an entry of dismissal, default, or final order.

##### NEW SECTION

#### WAC 242-02-720 DISMISSAL OF ACTION.

Any action may be dismissed by a board:

- (1) When all parties stipulate;
- (2) Upon motion of the petitioner prior to the presentation the respondent's case;
- (3) Upon motion by the respondent alleging that the petitioner has failed to prosecute the case, failed to comply with these rules, or failed to follow any order of the board; or (4) Upon a board's own motion for failure by the parties to comply with these rules or any order of the board.

#### DISPOSITION OF PETITIONS FOR REVIEW AFTER HEARING

##### NEW SECTION

WAC 242-02-810 PRESENTATION OF POST HEARING MATTERS. Unless requested by or authorized by a board no post hearing evidence, documents, briefs or motions will be accepted. A board may request submission of proposed findings of fact, conclusions of law and final order.

##### NEW SECTION

WAC 242-02-820 DISPOSITION OF PETITION FOR REVIEW. Disposition of a petition for review by a board shall be by final decision and order pursuant to WAC 242-02-830 or by initial decision and order pursuant to WAC 242-02-840 through -870.

##### NEW SECTION

#### WAC 242-02-830 DISPOSITION OF PETITION FOR REVIEW — FINAL DECISION AND ORDER.

(1) When the hearing on the petition for review has been heard by a majority of a board, a written final decision and order concurred in by at least two members may be

adopted. The board shall issue a written decision containing appropriate findings and conclusions.

(2) After issuance of a final decision under this section, any party may file a petition for reconsideration with a board. Such petition must be filed within ten days of mailing of the final decision. The original and three copies of the petition for reconsideration shall be filed with the board. At the same time, copies shall be served on all parties of record. A board may require other parties to supply an answer which shall be served in a like manner.

(3) The filing of a petition for reconsideration shall suspend the final decision of a board until the petition is denied or a modified decision is entered by the board.

(4) In response to a petition for reconsideration, the board may deny the petition, modify its decision, or reopen the hearing. A petition is deemed denied unless the board takes action within twenty days of filing of the petition or answer where a board has required other parties to provide such an answer pursuant to subsection (2).

(5) A decision in response to the petition for reconsideration shall constitute a final decision and order for purposes of judicial review. Copies of the final decision and order shall be mailed by the board to each party and to its attorney or representative of record.

**Reviser's note:** The spelling error in the above section occurred in the copy filed by the agency and appears in the Register pursuant to the requirements of RCW 34.08.040.

##### NEW SECTION

WAC 242-02-840 DISPOSITION OF PETITION FOR REVIEW — INITIAL DECISION AND ORDER. When a hearing on the matter has been heard by less than the majority of a board, or when less than a majority of a board concurs in a matter, or when a board may otherwise elect to do so, a written initial decision and order shall be prepared which shall contain appropriate findings and conclusions.

##### NEW SECTION

WAC 242-02-850 DISPOSITION OF INITIAL DECISION — EXCEPTIONS. (1) Time for Filing. Within ten days from the date of mailing of the initial decision and order, any party may file with a board an original and three copies of a written statement of exceptions. Copies shall be furnished to all other parties.

(2) The statement shall set forth the grounds for exception in detail and the party or parties filing the same shall be deemed to have waived all objections for irregularities not specifically set forth. A general exception to Findings of Fact on the ground that the weight of evidence is to the contrary shall not be considered sufficient compliance, unless the exception shall refer to the evidence relied upon. If legal issues are involved, the statement of exception shall set forth the legal theory relied upon, citations of authority and supporting argument. The statement of exceptions should also contain proposed findings of fact or conclusions of law as appropriate, covering the factual and legal issues to which exceptions are being taken.

(3) Reply to Exceptions. Any party may, within ten days of service, submit a reply brief to exceptions. A board may, on its own motion, require the parties to submit written briefs or to appear and present oral argument regarding the matters on which exceptions were taken.

(4) Exceptions to Rulings. If an exception is taken to a ruling or rulings of a presiding officer sustaining an objection to admissibility of evidence, or denying a continuance for the presentation of further evidence, and a board determines that said ruling or rulings were erroneous, the board may: (a) return the case to the presiding officer with appropriate instructions, or (b) open the matter for further argument and decision by the board itself.

NEW SECTION

WAC 242-02-860 DISPOSITION OF PETITION FOR REVIEW — FINALITY OF INITIAL DECISION AND ORDER. In the event no statement of exception is filed as provided herein by any party, the proposed decision and order of the presiding officer may be adopted by a board and become the final decision and order of the board. Such adoption of the proposed decision and order shall be the final decision of a board for purposes of judicial review.

NEW SECTION

WAC 242-02-870 DISPOSITION OF PETITION FOR REVIEW — FINAL DECISION AND ORDER — EXCEPTIONS FILED. After the filing of a statement or statements of exception and reply, if any, and the filing of briefs or presentation of oral argument, if required, the record before a board or presiding officer shall be considered by at least two members of the board; provided that if no two members agree on a decision, the third member must consider the record before the board; and further provided, that if no two members can agree on a decision in any case, the governmental action giving rise to the petition for review will stand.

NEW SECTION

WAC 242-02-880 DISPOSITION OF PETITION FOR REVIEW — TRANSCRIPTS. The following shall be the policy of each board with regard to transcription of the record:

(1) If less than two members of a board are present at the hearing and if exceptions to the proposed decision and order of the board or presiding officer have been timely filed as provided by WAC 242-02-850, the board may order a transcript or copy of an electronic recording. Any party may obtain a copy upon payment of the reasonable costs thereof.

(2) A board, in its discretion, may at any time cause a transcript to be printed.

(3) In any case when a board shall not cause the transcript to be printed, it shall be the obligation of the party wishing a transcript, or portions of it, to assume the cost of producing the same.

(4) When an appeal is taken from any final decision of a board to the Superior Court of Thurston County,

the appealing party is responsible for ordering and paying for the transcript of the hearing.

NEW SECTION

WAC 242-02-890 POST DECISION HEARING — DETERMINATION OF COMPLIANCE OR NON-COMPLIANCE WITH FINAL ORDER. (1) In those cases where a board finds that a state agency, county or city is not in compliance with the requirements of the act, the board shall remand the matter to the affected state agency, county or city, specifying a reasonable time not in excess of one hundred eighty days within which the state agency, county or city shall comply. Within sixty days of the compliance date, the board, on its own motion or motion of the petitioner, shall set a hearing for the purpose of determining compliance.

(2) The time and place of the compliance hearing shall be at the discretion of a board. Such a hearing shall be given the highest priority of business to be conducted by the board.

(3) The compliance hearing shall be scheduled and heard, and a finding shall be issued by the board, within forty-five days of the filing of the motion under subsection (1).

(4) If a board finds that the state agency, county or city is not in compliance, the board shall transmit its findings to the Governor. A board may recommend to the Governor that sanctions authorized by the act be imposed.

DECLARATORY RULINGS

NEW SECTION

WAC 242-02-910 PETITIONS FOR DECLARATORY RULING. (1) Any person may petition a board for a declaratory ruling with respect to the applicability to specific circumstances of a rule, order, or statute within a board's jurisdiction. The petition shall set forth facts and reasons on which the petition relies to show:

(a) That uncertainty necessitating resolution exists;

(b) That there is actual controversy arising from the uncertainty such that a declaratory ruling will not be merely an advisory opinion;

(c) That the uncertainty adversely affects the petitioner;

(d) That the adverse effect of uncertainty outweighs any adverse effects on others or on the general public that may likely arise from the order requested; and

(e) That the petition complies with any additional requirements established by the board.

(2) Form of the Petition. The form of the petition for declaratory ruling shall generally adhere to the following:

(a) At the top of the page shall appear the wording "Before the . . . . . Growth Planning Hearings Board". On the left side of the page below the foregoing, the following caption shall be set out: "In the Matter of the Petition of (name of petitioning party) For a Declaratory Ruling". Opposite the foregoing caption shall appear the word "Petition".

(b) The body of the petition shall be set out in numbered paragraphs. The first paragraph shall state the

name and address of the petitioning party. The second paragraph shall state all rules or statutes that may be brought into issue by the petition. Succeeding paragraphs shall set out the state of facts relied upon in form similar to that applicable to complaints in civil actions before Superior Courts of this state. The concluding paragraphs shall contain the relief requested. The petition shall be subscribed and verified in the manner prescribed for certification of petitions in these rules.

(c) The original and three copies shall be filed with the board.

(3) Consideration of Petition. A board shall consider the petition and within thirty days shall:

- (a) Issue a nonbinding declaratory ruling;
(b) Notify the petitioner that no declaratory ruling is to be issued; or

(c) Set a time and place for a hearing or for submission of written evidence on the matter, which shall occur within ninety days of the receipt of the petition, and give at least seven days notification to the petitioner of the time and place for such hearing or submission and of the issues involved.

(4) Disposition of Petition. If the hearing is held or evidence is submitted as provided in subsection 3(c) above, a board shall, within a reasonable time:

- (a) Issue a binding declaratory ruling; or
(b) Issue a nonbinding declaratory ruling; or
(c) Notify the petitioner that no declaratory ruling is to be issued.

Reviser's note: The typographical errors in the above section occurred in the copy filed by the agency and appear in the Register pursuant to the requirements of RCW 34.08.040.

NEW SECTION

WAC 242-02-920 DECLARATORY RULING — NOTICE TO OTHER PERSONS. Within fifteen days after receipt of a petition for declaratory order, a board or presiding officer shall give notice of the petition to all persons to whom notice is required by law, and may give notice to any other person it deems desirable.

NEW SECTION

WAC 242-02-930 DECLARATORY RULING — DISPOSITION OF PETITION. A declaratory ruling entered by a board or a decision by a board to decline to enter a declaratory ruling shall be in writing and shall be served upon the petitioner and all other persons described in RCW 34.05.240(3). A decision issued shall be considered a final decision for purposes of judicial review.

CHAPTER 242-04 WAC PUBLIC RECORDS

Table with 2 columns: WAC number and description. Includes 242-04-010 Purpose, 242-04-020 Definitions, 242-04-030 Description of organization and public meetings, 242-04-040 Public records available.

Table with 2 columns: WAC number and description. Includes 242-04-050 Communications with each board or with the joint boards, 242-04-060 Public records officer, 242-04-070 Office hours, 242-04-080 Requests for public records, 242-04-090 Responses to requests for public records, 242-04-100 Copying, 242-04-110 Exemptions, 242-04-120 Review of denials of public records requests, 242-04-130 Protection of public records, 242-04-140 Records index, 242-04-150 Adoption of form.

NEW SECTION

WAC 242-04-010 PURPOSE. The purpose of this chapter is to ensure compliance by each board and the joint boards with the provisions of chapter 42.17 RCW, and in particular with RCW 42.17.250 through 42.17.340, dealing with public records.

NEW SECTION

WAC 242-04-020 DEFINITIONS. (1) "Board" means the Eastern Washington, Western Washington or Central Puget Sound Growth Planning Hearings Board. Each is a quasi-judicial body created pursuant to Chapter 36.70A RCW. Where appropriate the term board also refers to the staff and employees of each board.

(2) "Joint Boards" means the three independent boards meeting or acting jointly.

(3) "Public record" means any writing containing information relating to the conduct of government or the performance of any governmental or proprietary function prepared, owned, used, or retained by any state or local agency regardless of physical form or characteristics.

(4) "Writing" means handwriting, typewriting, printing, photostating, photographing, and every other means of recording any form of communication or representation, including, but not limited to, letters, words, pictures, sounds or symbols, or combination thereof, and all papers, maps, magnetic or paper tapes, photographic films and prints, motion pictures, film and video recordings, magnetic or punched cards, discs, drums, diskettes, sound recordings, and other documents including existing data compilations from which information may be obtained or translated.

NEW SECTION

WAC 242-04-030 DESCRIPTION OF ORGANIZATION AND PUBLIC MEETING. (1) Each board is an independent agency of the state of Washington, composed of three members appointed by the governor. Each board elects an administrative chairperson from its members at least annually.

(2) The administrative chairpersons constitute the administrative committee of the joint boards. The administrative committee elects an administrative chairperson from its members at least annually.



(3) Regular meetings of each board will be held at its principal office or such other place as each board designates as follows:

(a) Eastern Washington board – every Tuesday at 10:30 a.m..

(b) Western Washington board – every Wednesday at 10:30 a.m..

(c) Central Puget Sound board at 10:00 a.m. on the second Thursday of each month.

(4) The joint boards shall meet annually on the second Monday in August.

**Reviser's note:** The typographical errors in the above section occurred in the copy filed by the agency and appear in the Register pursuant to the requirements of RCW 34.08.040.

#### NEW SECTION

WAC 242-04-040 PUBLIC RECORDS AVAILABLE. All public records of each board and of the joint boards, as defined in WAC 242-04-020, are deemed to be available for public inspection and copying pursuant to these rules, except as otherwise provided by RCW 42.17.310 and other laws.

#### NEW SECTION

WAC 242-04-050 COMMUNICATIONS WITH EACH BOARD OR THE JOINT BOARDS. (1) All communications with a board, including but not limited to the submission of materials pertaining to its operations and/or administration or enforcement of chapter 42.17 RCW and these rules, requests for copies of each board's decisions and other matters, shall be addressed to the appropriate board's office as follows:

(1) Eastern Washington Growth Planning

Hearings Board

1118 Larson Building

6 South 2nd Street

Yakima, Washington 98901

(509) 454-7803

(2) Western Washington Growth Planning

Hearings Board

P.O. Box 40953

Olympia, Washington 98504-0953

(206) 438-8760

(3) Central Puget Sound Growth Planning

Hearings Board

600 University – Suite 2329

Seattle, Washington 98101-1129

(206)

(2) All communications with the joint boards shall be addressed in care of the Western Washington board.

**Reviser's note:** The spelling error in the above section occurred in the copy filed by the agency and appears in the Register pursuant to the requirements of RCW 34.08.040.

#### NEW SECTION

WAC 242-04-060 PUBLIC RECORDS OFFICER. (1) The administrative chairperson of each board, or his/her designee, shall be in charge of the public records.

(2) The administrative chairperson of the joint boards, or designee, shall be in charge of the public records.

(3) Such persons shall be responsible for implementation of these rules and regulations regarding release of public records, and generally assuring compliance with the public records disclosure requirements of chapter 42.17 RCW, and in particular RCW 42.17.250 through 42.17.340.

#### NEW SECTION

WAC 242-04-070 OFFICE HOURS. Public records shall be available for inspection and copying during the customary office hours of each board. For the purposes of this chapter, the customary office hours shall be from 8:00 a.m. to noon and from 1:00 p.m. to 5:00 p.m., Monday through Friday, excluding legal holidays.

#### NEW SECTION

WAC 242-04-080 REQUESTS FOR PUBLIC RECORDS. In accordance with the provisions of chapter 42.17 RCW, that agencies prevent unreasonable invasions of privacy, protect public records from damage or disorganization, and prevent excessive interference with essential functions of the agency, public records may be inspected or copied, or copies of such records may be obtained, by members of the public, upon compliance with the following procedures:

(1) A request shall be made in writing upon a form prescribed by a board or the joint boards which shall be available at its office. The form shall be presented to that board or to any member of the board's staff at the office of the board during customary office hours. The request shall include the following information:

(a) The name of the person requesting the record and the organization represented, if any;

(b) The time of day and calendar date on which the request was made;

(c) A description of the material requested;

(d) If the matter requested is referenced within the current index maintained by the records officer, a reference to the requested record as it is described in such current index;

(e) If the requested matter is not identifiable by reference to a current index, an appropriate identification of the record requested.

(2) In all cases in which a member of the public is making a request, it shall be the obligation of the board or staff member to whom the request is made, to assist the member of the public in appropriately identifying the public record requested.

**Reviser's note:** The spelling error in the above section occurred in the copy filed by the agency and appears in the Register pursuant to the requirements of RCW 34.08.040.

#### NEW SECTION

WAC 242-04-090 RESPONSES TO REQUESTS FOR PUBLIC RECORDS. Within five business days of receiving a public record request, each board must respond by either (1) providing the record;

(2) acknowledging that the board has received the request and providing a reasonable estimate of the time the board will require to respond to the request. Additional time required to respond to a request may be



based upon the need to clarify the intent of the request, to locate and assemble the information requested, to notify third persons or agencies affected by the request, or to determine whether any of the information requested is exempt and that a denial should be made as to all or part of the request. In acknowledging receipt of a public record request that is unclear, a board may ask the requestor to clarify what information the requestor is seeking. If the requestor fails to clarify the request, the board need not respond to it, or

(3) denying the public record request.

#### NEW SECTION

**WAC 242-04-100 COPYING.** No fee shall be charged for the inspection of public records. Each board shall charge a reasonable fee for providing copies of public records and for use of each board's photocopy equipment. The charge is the amount necessary to reimburse each board for its actual costs incident to such copying.

#### NEW SECTION

**WAC 242-04-110 EXEMPTIONS.** (1) Each board reserves the right to determine that a public record requested in accordance with the procedures outlined in WAC 243-04-080 is exempt under the provisions of RCW 42.17.310 including, but not limited to the following:

(a) Personal information in files maintained for members and employees of each board to the extent that disclosure would violate their right to privacy;

(b) Preliminary drafts, notes, recommendations, and intra-agency memoranda in which opinions are expressed or policies formulated or recommended, except that a specific record shall not be exempt when publicly cited by an agency in connection with any agency action;

(c) All applications for public employment, including the names of applicants, resumes, and other related materials submitted with respect to an applicant;

(d) The residential addresses and residential telephone numbers of employees or volunteers of a public agency which are held by the agency in personnel records, employment or volunteer rosters, or mailing lists of employees or volunteers.

(2) Pursuant to RCW 42.17.260, each board reserves the right to delete identifying details when it makes available or publishes any public records, in all cases when there is reason to believe that disclosure of such details would be an invasion of personal privacy protected by chapter 42.17 RCW. Each board will fully justify such deletion in writing.

(3) All public records otherwise exempt by law shall be considered exempt under the provision of these rules.

#### NEW SECTION

**WAC 242-15-120 REVIEW OF DENIALS OF PUBLIC RECORDS REQUESTS.** Any person who objects to a denial of a public records request or who objects to the reasonableness of the estimate of the time a board requires to respond to a public records request,

shall petition the superior court in the county in which the record is maintained under the provisions of RCW 42.17.340.

**Reviser's note:** The above new section was filed by the agency as WAC 242-15-120. This section is placed among sections forming new chapter 242-04 WAC, and therefore should be numbered WAC 242-04-120. Pursuant to the requirements of RCW 34.08.040, the section is published in the same form as filed by the agency.

#### NEW SECTION

**WAC 242-04-130 PROTECTION OF PUBLIC RECORDS.** In order to protect the public records in the custody of each board or joint boards, the following guidelines shall be followed by any person inspecting such public records:

(1) No public records shall be removed from the office;

(2) Inspection of any public record shall be conducted in the presence of a board member or his/her designee;

(3) No public record may be marked or defaced in any manner during inspection;

(4) Public records which are maintained in the file jacket, or in chronological order, may not be dismantled except for purpose of copying, and then only by a member or designee;

(5) Access to file cabinets, shelves, vaults and other storage locations is restricted to board members and staff.

#### NEW SECTION

**WAC 242-04-140 RECORDS INDEX.** (1) Index. Each board and the joint boards has available to all persons a current index which provides identifying information as to those records applicable to each board, which have been issued, adopted or promulgated since May 15, 1992, as follows:

(a) Final orders, including concurring and dissenting opinions, made in the adjudication of cases;

(b) Those statements of policy and interpretations of policy, statute and the Constitution which have been adopted by a board;

(c) Administrative staff manuals and instructions to staff that affect a member of the public;

(d) Planning policies and goals, and interim and final planning decisions;

(e) Factual staff reports and studies, a consultant's factual reports and studies, scientific reports and studies, and any other factual information derived from tests, studies, reports, or surveys, whether conducted by public employees or others; and

(f) Correspondence, and materials referred to therein, by and with a board relating to any regulations, supervisory or enforcement responsibilities of a board, where a board determines or is asked to determine the rights of the state, the public, a subdivision of state government or of any private party.

(2) Availability. The current index promulgated by each board shall be available for inspection by all persons under the same rules and on the same conditions as are applied to public records available for inspection.

NEW SECTION

WAC 242-04-150 ADOPTION OF FORM. Each board and the joint boards adopt the use by all persons requesting inspection and/or copies of records the form set out below, entitled "Request for inspecting and/or copying public records".

We have received your request for inspection of and/or copies of our public records. Please complete this form and return it with the amount required, if applicable. We will forward the requested copies to you as soon as we receive this form with payment.

Return to:

[name and address of each board]

GROWTH PLANNING HEARINGS BOARD  
REQUEST FOR INSPECTING AND/OR  
COPYING PUBLIC RECORDS

Date: [Time Received]:  
Name:  
Address:

Description of Records (see index)

I certify that the information obtained through this request for public records will be used in compliance with chapter 42.17 RCW.

\_\_\_\_\_  
Signature

Number of Copies  
Number of Pages  
Per Page Cost \$  
Total Charge \$

Reviser's note: The brackets and enclosed material in the text of the above section occurred in the copy filed by the agency and appear in the Register pursuant to the requirements of RCW 34.08.040.

CHAPTER 242-06 WAC  
COMPLIANCE WITH STATE ENVIRONMENTAL  
PROTECTION ACT

WAC  
242-06-010 Purpose.  
242-06-020 Application.

NEW SECTION

WAC 242-06-010 PURPOSE. The purpose of this chapter is to comply with and implement RCW 43.21C-.120 directing every state agency to adopt rules pertaining to the integration of the policies and procedures of the State Environmental Protection Act into the various programs under their jurisdiction for implementation.

NEW SECTION

WAC 242-06-020 APPLICATION. The boards, both individually and collectively, have reviewed their authorized activities pursuant to WAC 197-11-800(12) and found them to be exempt under the provisions of chapter 197-11 WAC.

WSR 92-14-018  
PROPOSED RULES  
GAMBLING COMMISSION  
[Filed June 22, 1992, 2:02 p.m.]

Original Notice.

Title of Rule: See Purpose below.

Purpose: WAC 230-08-010 Monthly records, to remove crane games from rule; 230-08-025 Accounting records to be maintained by distributors and manufacturers, to remove crane games from rule; 230-08-180 Annual activity reports by commercial amusement game operators, clarify reporting requirements; 230-08-240 Annual activity reports by commercial, repeal rule; 230-50-010 Adjudicated proceedings—Hearings, clarify hearing requirements; 230-50-012 Summary suspensions, revise requirements to suspend a license; 230-50-015 Stay of summary suspension, new rule; 230-50-018 Review of orders on stay, new rule; 230-50-150 Adjudicated proceedings—Notice of hearing—Requirements; allows hearing to be conducted telephonically; 230-50-235 Brief adjudicative proceedings—Discovery limitations, new rule; and 230-50-580 Adjudicated proceedings—Hearings—Forms, new form for summary suspensions.

Statutory Authority for Adoption: RCW 9.46.070.

Statute Being Implemented: RCW 9.46.0331.

Reasons Supporting Proposal: To update WAC rules to support current policies of the commission.

Name of Agency Personnel Responsible for Drafting: Sharon M. Tolton, Rules Coordinator, Lacey, 438-7685; Implementation: Frank L. Miller, Director, Lacey, 438-7640; and Enforcement: Neal Nunamaker, Deputy Director, Lacey, 438-7690.

Name of Proponent: Washington State Gambling Commission, governmental.

Rule is not necessitated by federal law, federal or state court decision.

Explanation of Rule, its Purpose, and Anticipated Effects: [No information supplied by the agency.]

Proposal Changes the Following Existing Rules: [No information supplied by the agency.]

Small Business Economic Impact Statement: [No information supplied by the agency.]

Hearing Location: SeaTac Red Lion Inn, 18740 Pacific Highway South, Seattle, WA 98188, on September 11, 1992, at 10:00 a.m.

Submit Written Comments to: Washington State Gambling Commission, P.O. Box 42400, Olympia, WA 98504-2400, by September 9, 1992.

Date of Intended Adoption: September 11, 1992.

June 22, 1992  
Frank L. Miller  
Director

AMENDATORY SECTION (Amending Order 223, filed 6/17/91, effective 7/18/91)

WAC 230-08-010 MONTHLY RECORDS. Every person or organization licensed to operate any authorized gambling activity shall keep and maintain permanent monthly records of all of the activities of the licensee related to each licensed activity. Each of these records shall be maintained by the licensee for a period of not less than three years from the end of the fiscal year for which the record is kept unless the licensee is released by the commission from this requirement as to

any particular record or records. These records must include all financial transactions and contain enough detail to determine compliance with the requirements of WAC 230-04-024, 230-04-080 and 230-08-122. The record for each licensed activity shall be a separate unit, covering all transactions occurring during a calendar month. These records shall be complete in every detail and available for audit or inspection by agents of the commission or other law enforcement personnel no later than thirty days following the end of each month. Each record shall include, but not necessarily be limited to, all details of the following:

(1) The gross gambling receipts from the conduct of each of the activities licensed.

(2) Full details on all expenses related to each of the activities licensed.

(3) The total cost of all prizes paid out for each of the activities licensed.

(4) With respect to those organizations licensed as qualified bona fide charitable or bona fide nonprofit organizations, except agricultural fairs, records shall clearly show in detail how those proceeds from each licensed activity obtained by the licensee were used or disbursed by that licensee.

(5) With respect to commercial stimulant licensees, records shall include at least the following details:

(a) Gross sales of food and drink for consumption on their licensed premises;

(b) Gross sales of food and drink for consumption off the licensed premises; and

(c) Gross sales from all other business activities occurring on the licensed premises.

(6) In addition to any other requirement set forth in these rules, licensees for the operation of punchboards and pull tabs shall be required to prepare a detailed monthly record for punchboards and pull tab series removed from play during that month. This detailed monthly record shall be recorded in a standard format prescribed by the commission and shall disclose for each set at minimum the following information:

(a) The name of the punchboard or pull tab series;

(b) The Washington state identification and inspection services stamp number issued by the commission and placed thereon: Provided, that when records entry labels are attached to the punchboard or pull tab series flare, a label shall be attached to the record in lieu of a written entry;

(c) The date removed from play;

(d) The total number of tabs in each pull tab series or the total number of punches in each punchboard;

(e) The number of pull tabs or punches remaining after removal from play;

(f) The number of pull tabs or punches played from the pull tab series or punchboard;

(g) The cost to the players to purchase one pull tab or one punch;

(h) The gross gambling receipts as defined in WAC 230-02-110;

(i) The total prizes paid, including both cash and merchandise (calculated by the cost to the licensee) prizes;

(j) The net gambling receipts (gross gambling receipts less total prizes paid);

(k) The cash over or short determined by ~~((+))~~ (i) subtracting actual cash from net gambling receipts for punchboards and pull tabs which pay cash prizes, and ~~((+))~~ (ii) subtracting actual cash from gross receipts for punchboards and pull tabs which award merchandise prizes; and

(l) The actual cash received from the operation of each pull tab series or punchboard; and,

(m) With written commission approval, licensees operating pull tabs to stimulate food and drink sales may record (k) and (l) of this subsection in total on a daily, weekly, or monthly basis, if their ~~((record keeping))~~ recordkeeping procedures meet commission standards.

~~(7) ((In addition to any other requirements set forth in these rules, electronic crane operators who own or lease the games shall be required to prepare a detailed monthly record covering the operation of each machine. This record shall contain the following for each machine and location:~~

~~(a) The commission identification stamp number of each game;~~

~~(b) The coin-in meter reading at the beginning of the month;~~

~~(c) The coin-in meter reading at the ending of the month;~~

~~(d) The number of plays;~~

~~(e) The gross gambling receipts;~~

~~(f) Number of prizes awarded;~~

~~(g) Cost of prizes awarded;~~

~~(h) Net gambling receipts;~~

~~(i) The actual cash removed; and~~

~~(j) The cash over and short.~~

~~((+)) Copies of all additional financial data which support tax reports to any and all governmental agencies.~~

**AMENDATORY SECTION** (Amending Order 201, filed 11/27/89, effective 12/28/89)

WAC 230-08-025 ACCOUNTING RECORDS TO BE MAINTAINED BY DISTRIBUTORS AND MANUFACTURERS. Every licensed distributor and manufacturer shall keep and maintain a complete set of records which include all details of all activities of the licensee related to the conduct of the licensed activity. These records shall be recorded using the double entry accounting system and maintained in accordance with generally accepted accounting principles. This system shall also be on the same basis as the licensee's federal income tax return. All records shall be maintained for a period of not less than three years following the end of the licensee's fiscal year. These records shall be updated at least once a month and provide a monthly balance for each account. The minimum record system shall include the following:

(1) Sales invoices - every manufacturer and distributor shall record every sale, return, or any other type of transfer of punchboards/pull tabs, or pull tab dispensing devices ~~((or electronic crane game))~~ by completing a standard sales invoice or credit memo. These invoices shall set out the following information:

(a) Each invoice must be prenumbered at the time of purchase. The numbering must be consecutive, using not less than four digits: Provided, that manufacturers may use a computer generated numbering system if the same system is used for all sales and specific numbers can not be input by use of a manual override function;

(b) The date of sale. For distributors only: If the date of delivery is different, then the delivery date must also be entered;

(c) The customer's name and an adequate business address;

(d) A full description of each item sold, including the identification and inspection services stamp number for each item. For all sales occurring after December 31, 1988, distributors shall use a standard invoice in a format prescribed and approved by the commission. A separate line shall be used for each stamp number. This invoice shall provide space for the operator to either attach a records entry label or enter the identification and inspection services stamp number and the date the device was placed out for play. These spaces shall be adjacent to the written entry of the I.D. stamp number made by the distributor;

(e) The quantity and sales price of each individual item, including individual items of merchandise to be used as prizes on punchboards and pull tabs;

(f) The gross amount of each sale to each customer including all discount terms and the total dollar amount of any discount;

(g) The sales invoice shall be prepared in at least three parts: Provided that after December 31, 1988, all distributor invoices shall have at least four parts; and the invoices shall be distributed and maintained as follows:

(i) The original shall be issued to the customer: Provided that after December 31, 1988, an additional copy of distributor invoices shall be provided to the customer;

(ii) One shall be retained in an invoice file by customer name; and

(iii) One shall be retained in an invoice file by invoice number or in an alternative manner that accounts for each invoice numerically. This provision may be waived if the licensee receives written commission approval.

(h) Credit memos for returned items shall be prepared in the same detail as ~~((items))~~ (a) through (g) ~~((above))~~ of this subsection.

(2) Sales journal - the sales journal shall contain at least, but not be limited to, the following by month:

(a) The date of the sale;

(b) The invoice number of the sale;

(c) The customer name or person remitting a payment;

(d) Sales shall be categorized at least by the following:

(i) Punchboards that pay out cash prizes;

(ii) Punchboards that pay out merchandise prizes;

(iii) Pull tabs that pay out cash prizes;

(iv) Pull tabs that pay out merchandise prizes;

(v) Pull tab dispensing devices;

(vi) Merchandise: Only that which is used as a prize on a punchboard, or pull tab series ~~((or in an electronic crane game:))~~;

(vii) ~~((Electronic crane games;~~

~~(viii))~~ Other types of sales including but not limited to, equipment leases, equipment sales, and bingo supplies.

(e) Total amount of the invoice;

(3) Cash disbursements book (check register) – this record shall include a recording of all checks issued by the licensee, cash payments made by the licensee, or payments made by any other means. All expenses by the licensee, both gambling and nongambling related, shall be documented by invoices or other appropriate supporting documents. Entries to this record shall contain at least, but not limited to, the following information by month:

(a) The date the check was issued or payment made;

(b) The number of the check issued;

(c) The name of the payee; and

(d) Each disbursement shall be categorized by type of expense.

(4) Cash receipts – all cash receipts shall be recorded in an original book of entry whether it be a sales journal, a check register, or a separate cash receipts journal, and at a minimum shall include a recording of not only cash sales, but also cash received from all sources, and shall contain at least, but not limited to, the following by month:

(a) The date the payment was received;

(b) The name of the person remitting the payment;

(c) The amount of payment received;

(5) General ledger – each licensee whose gambling related sales exceed \$500,000 per year, shall have a general ledger which shall contain, in addition to all other accounts by month, a separate sales account for each type of sale.

(6) Bank reconciliation – a bank reconciliation shall be performed each month. In addition, all undeposited funds at year end shall be reconciled in an account titled cash on hand.

(7) Copies of all financial data which support tax reports to any and all governmental agencies.

(8) Manufacturer shall maintain records that provide an accountability trail for all identification and inspection stamps purchased. These records shall include enough details to allow audit of all used, unused, and damaged stamps and includes the following minimum items:

(a) The name of the purchaser;

(b) The date of the sale; and

(c) The invoice number recording the sale.

(9) An alternative format may be used for ~~((sections))~~ subsections (1)(a), ((+))(g)(ii), ((+))(g)(iii), ((+))(h), (2), and (3), ((above)) of this section upon advance written approval from the commission.

AMENDATORY SECTION (Amending Order 227, filed 9/18/91, effective 10/19/91)

WAC 230-08-180 ~~((QUARTERLY))~~ ANNUAL ACTIVITY REPORTS BY COMMERCIAL AMUSEMENT GAME OPERATORS. (License Class ~~((E))~~ B and above) (1) Each licensee for the operation of commercial amusement games Class ~~((E))~~ B and above shall submit an activity report to the commission concerning the operation of the licensed activity and other matters set forth below ~~((during each of the following periods of the year:~~

~~(a) January 1st through March 31st;~~

~~(b) April 1st through June 30th;~~

~~(c) July 1st through September 30th; and~~

~~(d) October 1st through December 31st)).~~

(2) The report form shall be furnished by the commission and the completed report shall be received in the office of the commission or postmarked no later than ~~((60))~~ sixty days following the ~~((end of the period for which it is made))~~ license expiration date.

(3) The report shall be signed by the highest ranking executive officer or their designee. If the report is prepared by someone other than the licensee or their employee, then the preparer's name and business telephone number must be provided.

~~(4) ((If the licensee does not renew his license, then he shall file a report for the period between the previous report filed and the expiration date of his license.~~

~~((5))~~ The report shall be completed in accordance with the related instructions furnished with the report. The report shall include the following:

(a) The total gross gambling receipts;

(b) The total cost to the licensee of all prizes awarded;

(c) Full details of all expenses related to the purchase and operation of amusement games;

(d) Total net gambling income;

~~((6))~~ (5) In addition to the above, commercial amusement game ((operators)) licensees operating amusement games at locations on a

temporary basis set forth in WAC 230-04-138 ((shall provide)) (1)(a), (d), or (e) or as authorized by WAC 230-20-670(2) shall provide for each separate location:

(a) The ~~((business))~~ name and address of ((each location)) the business and/or event;

(b) The total gross gambling receipts received; and

(c) The amount of funds distributed to ~~((each licensee))~~ the premise/location owner.

#### REPEALER

The following section of the Washington Administrative Code is repealed:

WAC 230-08-240 ANNUAL ACTIVITY REPORTS BY COMMERCIAL AMUSEMENT GAME OPERATORS CLASS A AND B.

AMENDATORY SECTION (Amending Order 200, filed 11/27/89, effective 12/28/89)

WAC 230-50-010 ADJUDICATED PROCEEDINGS—HEARINGS. (1) Adjudicated proceedings shall be commenced for any and all matters wherein the commission is causing administrative charges to be brought against any applicant, licensee or permittee within the limitations to chapter 34.05 RCW as applicable.

(2) The commission shall afford an applicant for a license an opportunity for an adjudicated proceeding prior to denying such application, and shall afford a licensee the opportunity for an adjudicated proceeding prior to suspending or revoking a license.

~~(3) ((The commission will afford a person applying to the commission to exceed the limit on gross receipts in bingo games under WAC 230-20-251 an opportunity for an adjudicated proceeding prior to denying that application.~~

~~((4))~~ The commission will afford a person applying to the commission for approval of a pull tab dispensing device under WAC 230-30-095 an opportunity for an adjudicated proceeding prior to denying approval of such device.

~~((5))~~ (4) No hearing will be conducted with respect to any adjudicated proceeding unless ((+)) an application for an adjudicated proceeding and request for hearing is timely filed by the applicant or licensee with the commission in compliance with WAC 230-50-210. The application must be made upon a form to be obtained from the commission, or facsimile thereof, and must be received within 20 days following service upon the party affected by the commission or the director of a notice of administrative charges and opportunity for an adjudicated proceeding. Said document shall contain the maximum penalty that may be assessed should an application not be filed by the party affected. An application for an adjudicated proceeding and request for hearing shall accompany all notices of administrative charges.

~~((6))~~ (5) If an application for an adjudicated proceeding is not timely filed, then the party affected shall have waived the right to a hearing on the allegations set forth in the notice of administrative charges. The party shall be deemed to be in default pursuant to RCW 34.05.440 and the commission and director may take action against the party not to exceed the maximum penalty as stated in the notice of administrative charges and opportunity for an adjudicated proceeding, which action shall be final.

(6) The procedures of RCW 34.05.485, brief adjudicative proceedings, shall be used for the following purposes:

(a) All hearings in which the penalty sought by the commission is for a suspension of seven days or less;

(b) Hearings held pursuant to WAC 230-50-015 (stay of summary suspension);

(c) Hearings in which the parties have stipulated to facts or the parties have stipulated to charges, and the hearing is limited to a determination of whether facts constitute violations as charged and/or determination of appropriate penalty to be imposed; or

(d) Where the parties have stipulated to the use of brief adjudicative proceedings.

AMENDATORY SECTION (Amending Order 207, filed 3/13/90, effective 4/13/90)

WAC 230-50-012 SUMMARY SUSPENSIONS. (1) Pursuant to RCW 34.05.422(4), the director may ~~((summarily suspend a license or permit issued pursuant to these rules pending a hearing upon suspension or revocation of the license, or issuance of a renewal thereof;~~

for a period not to exceed 90 days when in the opinion of the commission or the director:

(a) The licensee or permittee has obtained the license or permit by fraud, trick, misrepresentation, concealment, or through inadvertence or mistake; or

(b) The licensee or permittee has engaged in any act, practice or course of operation as would operate as a fraud or deceit on any person, or has employed any device, scheme or artifice to defraud any person; or

(c) The licensee or permittee has again violated, failed, or refused to comply with any of the provisions, requirements, limitations, or duties imposed by chapter 9.46 RCW and any amendments thereto, or any rules adopted by the commission pursuant thereto, after having been previously notified by the commission, its authorized representatives, or by local law enforcement personnel, that a violation or violations of the same or similar provisions had been, or were being, committed by the licensee or permittee; or

(d) Immediate cessation of the licensed or permitted activities by the licensee or permittee is necessary for the protection or preservation of the welfare of the community within which these activities are being conducted:

(2)) exercise the commission's authority to summarily suspend any license or permit issued to such licensee or permittee upon a determination that one or more of the actions identified in subsection (2) of this section have occurred and that immediate cessation of the licensed or permitted activities is necessary for the protection or preservation of the safety and welfare of the public. Suspension of a license under this provision shall take effect immediately upon service of the summary suspension order unless otherwise provided in the order.

(2) The commission deems the following actions of a licensee or permittee to constitute an immediate danger to the public safety and welfare which may require the immediate cessation of licensed or permitted activities:

(a) Failure or refusal to comply with the provisions, requirements, conditions, limitations, or duties imposed by chapter 9.46 RCW and any amendments thereto, or any rules adopted by the commission pursuant thereto;

(b) Knowingly causing, aiding, abetting, or conspiring with another to cause any person to violate any of the laws of this state or the rules of the commission;

(c) Obtaining a license or permit by fraud, misrepresentation, concealment, or through inadvertence or mistake;

(d) Conviction of, or forfeiture of a bond upon a charge of, or having pled guilty to, forgery, larceny, extortion, conspiracy to defraud, willful failure to make required payments or reports to a governmental agency at any level, or filing false reports therewith, or of any similar offense or offenses, or of bribing or otherwise unlawfully influencing a public official or employee of any state or the United States, or of any crime, whether a felony or misdemeanor involving any gambling activity or physical harm to individuals or involving moral turpitude;

(e) Allowing any person who has been convicted of, or forfeited bond upon, any of the offenses included under (d) of this subsection, to participate in the management or operation of any activity regulated by the commission without prior written approval of the commission or its director;

(f) Licensee is subject to current prosecution or pending charges, or a conviction which is under appeal, for any of the offenses included under (d) of this subsection;

(g) Denying the commission or its authorized representatives, including authorized local law enforcement agencies, access to any place where a licensed activity is conducted or failure to promptly produce for inspection or audit any book, record, document, or item required by law or commission rule;

(h) Making a misrepresentation of, or failure to disclose, a material fact to the commission;

(i) Licensee has pursued or is pursuing economic gain in an occupational manner or context which is in violation of the criminal or civil public policy of this state if such pursuit creates probable cause to believe that the participation of such person in gambling or related activities would be inimical to the proper operation of an authorized gambling or related activity in this state. For the purposes of this section, occupational manner or context shall be defined as the systematic planning, administration, management, or execution of an activity for financial gain; and

(j) Licensee is a career offender or a member of a career offender cartel or an associate of a career offender or career offender cartel in

such a manner which creates probable cause to believe that the association is of such a nature as to be inimical to the policy of chapter 9.46 RCW or to the proper operation of the authorized gambling or related activities in this state. For the purposes of this section, career offender shall be defined as any person whose behavior is pursued in an occupational manner or context for the purpose of economic gain utilizing such methods as are deemed criminal violations of the public policy of this state. A career offender cartel shall be defined as any group of persons who operate together as career offenders.

(3) When a license or permit has been summarily suspended by the director, an adjudicated proceeding shall be commenced and the licensee or permittee shall be afforded an opportunity for a hearing before an Administrative Law Judge or the commission, upon the question of the suspension or revocation of the license or permit, or upon the renewal of the license or permit should it expire during the period of summary suspension. If an application for an adjudicated proceeding and request for hearing is timely filed by the licensee or permittee, then a hearing shall be held within 90 days of the effective date of the summary suspension ordered by the director.

#### NEW SECTION

WAC 230-50-015 STAY OF SUMMARY SUSPENSION. (1) Upon summary suspension of a license or permit by the director pursuant to WAC 230-50-012, an affected licensee or permittee may petition the commission for a stay of suspension pursuant to RCW 34.05.467 and 34.05.550(1). Such petition must be received by the commission within fifteen days of service of the summary suspension order.

(2) Within seven days of receipt of a petition for stay, a hearing shall be held before an administrative law judge appointed by the commission pursuant to WAC 230-50-020, or if an administrative law judge is not available during this period, before a commissioner designated by the chairperson. The hearing shall be limited to consideration of whether a stay should be granted, or whether the terms of the suspension may be modified to allow the conduct of limited activities under current licenses or permits.

(3) Any hearing conducted pursuant to subsection (2) of this section shall be conducted under RCW 34.05.485, brief adjudicated proceedings. The agency record for the hearing shall consist of the information upon which the summary suspension was based and may be supplemented by any information obtained by the commission subsequent to the date of the suspension order. The licensee or permittee shall have the burden of demonstrating by clear and convincing evidence that:

(a) The licensee or permittee is likely to prevail upon the merits at hearing;

(b) Without relief, the licensee or permittee will suffer irreparable injury. For purposes of this section, elimination of income from licensed activities shall not be deemed irreparable injury;

(c) The grant of relief will not substantially harm other parties to the proceedings; and

(d) The threat to the public safety or welfare is not sufficiently serious to justify continuation of the suspension, or that modification of the terms of the suspension will adequately protect the public interest.

(4) The initial order on stay shall be effective immediately upon service unless another date is specified in the order.

#### NEW SECTION

WAC 230-50-018 REVIEW OF ORDERS ON STAY. (1) The licensee, permittee, or agency may petition the commission for review of an initial order on stay. Petition for review must be in writing and received by the commission within twenty-one days of service of the initial order. If neither party has requested review within twenty-one days of service, the initial order shall be deemed the final order of the commission for purposes of RCW 34.05.467.

(2) If the commission receives a timely petition for review, the commission shall consider the petition at the next regularly scheduled meeting of the commission. Consideration on review shall be limited to the record of the hearing on stay. A commissioner acting as hearing officer pursuant to WAC 230-50-015(2) shall not be disqualified from considering the petition for review of an initial order on stay unless a party demonstrates grounds for disqualification in accordance with RCW 34.05.425.

(3) The order of the commission on the petition for review shall be effective upon service unless another date is specified in the order and is final pursuant to RCW 34.05.467. Final disposition of the petition for stay shall not affect subsequent administrative proceedings for suspension or revocation of a license or permit.

AMENDATORY SECTION (Amending Order 200, filed 11/27/89, effective 12/28/89)

WAC 230-50-150 ADJUDICATED PROCEEDINGS—NOTICE OF HEARING—REQUIREMENTS. All parties that have filed a timely application for adjudicated proceeding shall be served with a notice of hearing at least seven days before the date set for the hearing unless all parties consent to a shorter period. The notice shall state the time, ((place and issues involved, as required by RCW 34.04.090(1))) and place of the hearing and all other requirements of RCW 34.05.434(2): PROVIDED, That brief adjudicative proceedings, conducted pursuant to WAC 230-50-010(7) and RCW 34.05.485, shall normally be conducted telephonically and the place of the hearing will not be set in the notice of hearing. Either or both parties may request to appear in person and, in such cases, a place will be set and all parties notified.

NEW SECTION

WAC 230-50-235 BRIEF ADJUDICATIVE PROCEEDINGS—DISCOVERY LIMITATIONS. In all brief adjudicative proceedings, discovery requests to the agency shall be limited to requests for production of written reports and supporting documents relevant to the charges. Interrogatories and depositions shall not be allowed.

AMENDATORY SECTION (Amending Order 200 [90-13-022], filed 11/27/89 [6/11/90], effective 12/28/89 [7/31/90])

WAC 230-50-580 ADJUDICATED PROCEEDINGS—HEARINGS—FORMS. The following formats shall be utilized in all adjudicated proceedings:

(1) STATE OF WASHINGTON GAMBLING COMMISSION

In the Matter of the (Suspension/Revocation/Denial) of the (License/Application) to Conduct Gambling Activities of Licensee. NO. NOTICE OF ADMINISTRATIVE CHARGES AND OPPORTUNITY FOR AN ADJUDICATED PROCEEDING

(Director's Name) alleges as follows:

I

He is the Director of the Washington State Gambling Commission and makes these charges in his official capacity.

II

Jurisdiction of this proceeding is based on Chapter 9.46 RCW, Gambling, Chapter 34.05 RCW, the Administrative Procedure Act, and Title 230 WAC.

III

has been issued the following license(s) by the Washington State Gambling Commission, which license(s) (was/were) issued subject to compliance by the licensee with state laws and rules of the Commission.

- A. License Number Authorizing Activity
B. License Number Authorizing Activity
C. License Number Authorizing Activity

IV

(Attach Recital Of Charges)

(Appropriate Roman Numeral)

The charges specified in paragraphs through above constitute grounds for the day suspension, or revocation of the license(s) held by to conduct authorized gambling activity under authority of RCW 9.46.075 and WAC 230-04-400.

(Appropriate Roman Numeral)

The (licensee/applicant) shall be afforded the opportunity to have an Adjudicated Proceeding, which includes a hearing on the alleged violations. In order to commence an Adjudicative Proceeding, the enclosed APPLICATION FOR ADJUDICATED PROCEEDING AND REQUEST FOR HEARING MUST BE COMPLETED IN FULL by the LICENSEE OR REPRESENTATIVE and returned to the Gambling Commission within 20 days from the date of receipt of this notice. FAILURE TO RETURN THIS DOCUMENT WILL RESULT IN THE ENTRY OF A DEFAULT ORDER PURSUANT TO RCW 34.05.440 AND WAC 230-50-010, THE IMPOSITION OF THE PENALTY SET OUT ABOVE OR ONE OF LESSER DEGREE AND SHALL CONSTITUTE A WAIVER OF ANY FURTHER RIGHTS TO A HEARING OR REVIEW IN THIS MATTER.

STATE OF WASHINGTON }
COUNTY OF THURSTON } ss.

(Director's Name), being first duly sworn on oath, deposes and says: That he has read the foregoing Notice of Administrative Charges and Opportunity for Adjudicated Proceeding, knows the contents thereof, and believes the same to be true, and that he is the Director of the Washington State Gambling Commission and in that capacity has executed said Statement of Charges.

(Director's Name)

SUBSCRIBED AND SWORN TO before me this day of 19((89:))

NOTARY PUBLIC in and for the State of Washington residing at

(2) STATE OF WASHINGTON GAMBLING COMMISSION

In the Matter of the (Suspension/Revocation/Denial) of the (License/Application) to Conduct Authorized Gambling Activities of

NO.

(Licensee/Applicant.)

APPLICATION FOR ADJUDICATED PROCEEDING AND REQUEST FOR HEARING

THIS IS AN IMPORTANT NOTICE WHICH DETERMINES WHETHER OR NOT YOU WILL HAVE THE RIGHT TO A HEARING IN THIS MATTER. PLEASE READ THIS NOTICE CAREFULLY. IF YOU HAVE ANY QUESTIONS REGARDING YOUR LEGAL RIGHTS IN THIS MATTER YOU SHOULD CONTACT AN ATTORNEY.

In order to request and preserve your right to a hearing you MUST complete and sign this form, then return it by mail within 20 days to:

The Washington State Gambling Commission
4511 Woodview Drive SE ((Mail Stop QB-11))
Post Office Box 42400
((Lacey)) Olympia, Washington 98504-((812+)) 2400

FAILURE TO COMPLETE AND RETURN THIS FORM AS INSTRUCTED WILL RESULT IN THE ENTRY OF A DEFAULT ORDER AGAINST YOU PURSUANT TO RCW 34.05.440, and WAIVER of your rights to appeal in this matter.

YOU HAVE 20 DAYS FROM THE DATE OF RECEIPT OF THIS FORM TO COMPLETE AND RETURN IT TO THE ADDRESS ABOVE.

NO EXTENSIONS BEYOND THE 20 DAYS WILL BE GRANTED.

BRIEF EXPLANATION OF RIGHTS AND PROCEEDINGS:

You have the right to apply for an ADJUDICATIVE PROCEEDING, which includes a hearing on the allegations set forth in the notice of administrative charges. The hearing will be conducted by a state Administrative Law Judge pursuant to state law and administrative codes. You have the right to be represented by an attorney of your choice and at YOUR OWN EXPENSE.

You have the right to produce witnesses, and evidence relevant to the violations alleged. See WAC 230-50 for additional rights.

You have the right to have an interpreter for the proceedings if you or any witness which you will call is a limited English speaking person OR a hearing impaired person.

In order to request an interpreter, you MUST complete the attached REQUEST FOR INTERPRETER FORM and RETURN IT along with this form to the Gambling Commission. THIS SERVICE IS FREE OF CHARGE.

INSTRUCTIONS - Place a check mark and your signature next to the statement which describes your request(s) in this matter.

- Check Mark Signature
1) I want to have a hearing in this Adjudicated Proceeding
2) I will be represented by an attorney in this matter, his/her name, address and phone number are as follows: Name Address Phone Number
3) I will NOT be represented by an attorney in this matter.
4) I DO NOT want a HEARING AND WAIVE MY RIGHTS TO A HEARING IN THIS MATTER.

Please indicate those charges, if any, which you admit occurred.

You may attach a letter or a statement of your position in this matter if you choose to do so.

I attached a letter or statement
I did NOT attach a letter or statement

A HEARING, if requested, shall be conducted by a state Administrative Law Judge in a location near your place of business or residence...

If you do not understand any portion of these documents, you are strongly encouraged to contact an attorney.

You MUST complete, sign, date and then mail this document together with the REQUEST FOR INTERPRETER form, to the Washington State Gambling Commission...

Dated this \_\_\_ day of \_\_\_, 19(##) \_\_\_

\*\*SIGN HERE\*\*

LICENSEE OR REPRESENTATIVE

(3)

STATE OF WASHINGTON GAMBLING COMMISSION

In the Matter of the (Suspension/Revocation/Denial) of the (License/Application) to Conduct Authorized Gambling Activities of

(Licensee/Applicant)

NO. \_\_\_\_\_

APPLICATION FOR AN ADJUDICATED PROCEEDING AND REQUEST FOR HEARING WITH OFFER OF SETTLEMENT

THIS IS AN IMPORTANT NOTICE WHICH DETERMINES WHETHER OR NOT YOU WILL HAVE THE RIGHT TO A HEARING IN THIS MATTER. PLEASE READ THIS NOTICE CAREFULLY.

In order to request and preserve your right to a hearing you MUST complete and sign this form, then return it by mail within 20 days to:

The Washington State Gambling Commission
Post Office Box 42400
4511 Woodview Drive SE ((Mail Stop QB-11))
((Lacey)) Olympia, Washington ((98504-8121)) 98504-2400

FAILURE TO COMPLETE AND RETURN THIS FORM AS INSTRUCTED WILL RESULT IN THE ENTRY OF A DEFAULT ORDER AGAINST YOU PURSUANT TO RCW 34.05.440, and WAIVER of your rights to appeal in this matter.

YOU HAVE 20 DAYS FROM THE DATE OF RECEIPT OF THIS FORM TO COMPLETE AND RETURN IT TO THE ADDRESS ABOVE.

NO EXTENSIONS BEYOND THE 20 DAYS WILL BE GRANTED.

BRIEF EXPLANATION OF RIGHTS AND PROCEEDINGS:

You have the right to apply for an ADJUDICATIVE PROCEEDING which includes a hearing on the allegations set forth in the notice of administrative charges.

You have the right to produce witnesses, and evidence relevant to the violations alleged. See WAC 230-50 for additional rights.

You have the right to have an interpreter for the proceedings if you or any witness which you will call is a limited English speaking person OR a hearing impaired person.

In order to request an interpreter, you MUST complete the attached REQUEST FOR INTERPRETER FORM and RETURN IT along with this form to the Gambling Commission. THIS SERVICE IS FREE OF CHARGE.

INSTRUCTIONS - Place a check mark and your signature next to the statement which describes your request(s) in this matter.

Check Mark Signature

1) I WANT TO HAVE A HEARING IN THIS ADJUDICATED PROCEEDING

2) I will be represented by an attorney in this matter, his/her name, address and phone number are as follows:
Name
Address

Phone Number

3) I will NOT be represented by an attorney in this matter.

4) I DO NOT want a HEARING AND WAIVE MY RIGHTS TO A HEARING IN THIS MATTER.

5) I will agree to a stipulated settlement as stated on Page 3 and have signed the order on page 4

Please indicate those charges, if any, which you admit occurred.

You may attach a letter or a statement of your position in this matter if you choose to do so.

I attached a letter or statement
I did NOT attach a letter or statement

A hearing, if requested, shall be conducted by a state Administrative Law Judge in a location near your place of business or residence...

If you do not understand any portion of these documents, you are strongly encouraged to contact an attorney.

You MUST complete, sign, date and then mail this document together with the REQUEST FOR INTERPRETER form, to the Washington State Gambling Commission...

Dated this \_\_\_ day of \_\_\_, 19(##) \_\_\_

\*\*SIGN HERE\*\*

LICENSEE OR REPRESENTATIVE

I will agree to a stipulated settlement in this matter and the entry of the attached order on the following terms:

A suspension of \_\_\_ days for my \_\_\_ gambling license(s).
A fine of \_\_\_ in lieu of the \_\_\_ day suspension of my \_\_\_ gambling license(s).

The order finds that the violation(s) were in fact committed.

The dates for the suspension or fine will be as stated in the order. (Insert name of commission staff member) of the staff of the Commission can be contacted regarding changing the dates for the suspension and/or payment of the fine before the order is signed.

The dates of the suspension as set are no more than 90 calendar days from the date of mailing of this form to you and the fine is due PRIOR to the dates of the suspension.

By signing as indicated I agree to this settlement.

\*\*SIGN HERE\*\*

LICENSEE OR REPRESENTATIVE

DATE

YOU MUST ALSO SIGN THE ORDER ON PAGE FOUR WHERE INDICATED.

(4)

STATE OF WASHINGTON GAMBLING COMMISSION

An Adjudicated proceeding in the matter of the Suspension or Revocation of the license(s) to conduct Gambling Activities of:

(( )) Licensee

No.

Stipulated Settlement from Written Pre Hearing Offer



I

The licensee named hereon stipulates that the charges as set forth in the statement of charges attached hereto occurred and agrees to entry of a finding as such and conclusion of law or the violations.

II

That (Licensee's Name) has been issued (a) license(s) to conduct gambling activity(ies), as follows:

License Number (Insert License #) Authorizing (Type of Activity)
License Number (Insert License #) Authorizing (Type of Activity)
License Number (Insert License #) Authorizing (Type of Activity)

III

That the following is entered as the Final Order on these charges.

That the license(s) of (Licensees Name) to conduct (Type of activity) activity(ies) is hereby suspended for a term of ( ) days commencing (date suspension to start) and running through and including (date suspension will end). Provided further, that in lieu of said suspension the licensee may pay a fine of (\$ amount) on or before (Date).

Signed and dated this \_\_\_ day of \_\_\_, 19(90.) \_\_

(Name) Administrative Law Judge

(Licensee) or representative

(Asst. Attorney General)

(5)

STATE OF WASHINGTON GAMBLING COMMISSION

An Adjudicated Proceeding In the Matter of the (Suspension/Revocation/Denial) of the (License/Application) to Conduct Authorized Gambling Activities of

NO. \_\_\_\_\_ NOTICE OF HEARING

(Licensee/Applicant).

(ATTACH RECITAL OF CHARGES)

II

That the licensee(s) (was/were) previously notified of the administrative charges pending and (has/have) made a timely application for adjudicated proceeding and request for hearing. Based upon that request, a hearing will be conducted by \_\_\_\_\_, Administrative Law Judge of \_\_\_\_\_, phone number \_\_\_\_\_, on all charges as stated pursuant to WAC 230-50-010.

III

That the agency will be represented at the hearing by \_\_\_\_\_, Assistant Attorney General of \_\_\_\_\_, phone number \_\_\_\_\_. The licensee will be represented by \_\_\_\_\_ of \_\_\_\_\_, phone number \_\_\_\_\_.

IV

That the hearing is set for \_\_\_\_ at the hour of \_\_\_\_\_, in the city of \_\_\_\_\_ at \_\_\_\_\_. The hearing is being conducted under the authority of chapter 9.46 RCW and amendments thereto, and will be conducted pursuant to chapter 34.05 RCW and 230-50 WAC. Should the licensee and representatives fail to appear at the hearing as scheduled a default order pursuant to RCW 34.05.440 will be entered.

The proceeding will determine whether a suspension/revocation/or denial should be imposed.

(Director's Name)

(6)

STATE OF WASHINGTON GAMBLING COMMISSION

An Adjudicated Proceeding In the Matter of the (Suspension/Revocation/Denial) of the (License/Application) to Conduct Gambling Activities of:

No. \_\_\_\_\_ REQUEST FOR INTERPRETER AND/OR TRANSLATION OF DOCUMENTS

Licensee.

I, \_\_\_\_\_, being a party in this proceeding hereby state that I am a limited English speaking person or hearing impaired person or that I will be calling a

witness who is a limited English speaking or hearing impaired person and that (1/they) require an interpreter as indicated below:

(Check all items that apply and fill in the blank spaces.)

- I will require an interpreter for the \_\_\_\_\_ language.
I will require an interpreter for a hearing impairment.
I will be calling a limited English speaking witness who will require an interpreter in the \_\_\_\_\_ language.
I will be calling a hearing impaired person who will require an interpreter.
I request all documents in this proceeding be translated into the \_\_\_\_\_ language.

Signed: \_\_\_\_\_ Dated: \_\_\_\_\_

STATE OF WASHINGTON GAMBLING COMMISSION

In the Matter of the Summary Suspension of the License to Operate Gambling Activities of:

No. \_\_\_\_\_ FINDINGS, CONCLUSIONS, AND ORDER OF SUMMARY SUSPENSION OF LICENSES

(Licensee's Name) Licensee.

Pursuant to RCW 34.05.422(4), the Commission may summarily suspend a license pending proceedings for revocation or other action. The Commission has authorized the Director to summarily suspend a license pursuant to WAC 230-50-012. This matter then having been brought before the Director for a summary disposition pursuant to this authority on (date), and the Director acting pursuant to this authority has issued this order and caused it to be served upon the licensee. The order contained herein shall be deemed effective immediately upon its service to the licensee, authorized representative, or agent thereof, unless otherwise specified herein. By this authority, an authorized agent of the Commission shall under the terms hereof seize all current licenses authorizing gambling activity and all such gambling activity shall cease as ordered herein.

FINDINGS OF FACT

I

That (director's name) is the Director of the Washington State Gambling Commission and issues this order in that capacity.

II

That (licensee's name) has been issued (a) license(s) to operate the following authorized gambling activity(ies):

License Number 211- Authorizing Activity
License Number 211- Authorizing Activity
License Number 211- Authorizing Activity

Which license(s) (was/were) issued subject to compliance with all of the applicable statutes and regulations governing gambling activities.

III

After a thorough review of the affidavit(s) of the special agent(s) of the Commission concerning the facts in this matter, which are attached hereto and labeled as Attachment(s) (list), the Director accepts (this/these) as a verity and makes the determination that the action as ordered herein is warranted.

IV

(State charge)

That the violation(s) as stated require the immediate cessation of the gambling activity in that the safety and welfare of the public is affected as follows: (State reason(s) affected from WAC 230-50-012 (2)(a) - (k), as applicable)

CONCLUSIONS OF LAW

I

Based on the foregoing Findings of Fact, the Director, (director's name), makes the following CONCLUSIONS:

II

(select from WAC 230-50-012 (2)(a) - (k), as applicable)

III

That the circumstances as set forth in paragraph(s) ..... through ..... above constitute grounds for the suspension or revocation of the license(s) issued by the Washington State Gambling Commission under RCW 9.46.075 and WAC 230-04-400, and further constitute an immediate danger to the public safety and welfare.



IV

Immediate cessation of the licensed or permitted activities by the licensee or permittee is necessary for the protection or preservation of the welfare of the community within which these activities are being conducted.

V

(director's name), Director, has the authority pursuant to WAC 230-50-012 to issue the following ORDER:

ORDER

Based upon the foregoing FINDINGS OF FACT AND CONCLUSIONS, it is the ORDER of the undersigned Director, pursuant to authority granted to him by RCW 34.05.422 and WAC 230-50-012, that the license of (licensee's name) to operate [type(s) of activity] within the state of Washington is hereby suspended pending a formal hearing by an Administrative Law Judge or the Commission for suspension or revocation of said license, said suspension or revocation to be effective (immediately) [as of (date), at (time)].

STATEMENT OF RIGHTS

(1) You have a right to a prompt hearing on this matter. You may request a hearing by completing and returning to the Commission the enclosed Application for Adjudicated Proceeding and Request for Hearing. Failure to submit the Application for Adjudicated Proceeding and Request for Hearing form within twenty (20) days of service of this order upon you shall result in a waiver of your right to an adjudicated proceeding and entry of an order in default under RCW 34.05.440. If a timely application for a hearing is received, a hearing shall be conducted not sooner than seven (7) days nor later than 90 days from the date of service of this Order unless otherwise agreed to by the parties: PROVIDED, That you may waive the seven (7) day notice rule of WAC 230-50-030(2) and request a hearing at an earlier date.

(2) You have a right to petition for a stay of this order. You may request a stay by filing a written request with the Commission. Any request for a stay must be received by the Commission within fifteen (15) days of service of this order upon you. If a timely request for a stay is received by the Commission, a hearing regarding a request for stay will be conducted in accordance with WAC 230-50-015. A request for a stay does not constitute a request for a hearing as provided in paragraph (1) of this Statement of Rights.

DATED this \_\_\_ day of \_\_\_, 199\_.

(director's name)
Director

STATE OF WASHINGTON }
COUNTY OF THURSTON } ss.

(director's name), being first duly sworn on oath, deposes and says: That he has read the foregoing Order of Summary Suspension of License and Notice of Hearing, knows the contents thereof, and believes the same to be true, and that he is the duly appointed and qualified Director of the Washington State Gambling Commission and in that capacity has executed said Order of Summary Suspension of the License and Notice of Hearing.

(director's name)
Director

SUBSCRIBED AND SWORN TO before me this \_\_\_ day of \_\_\_, 199\_.

NOTARY PUBLIC in and for
the State of Washington
residing at

Reviser's note: The bracketed material preceding the section above was supplied by the code reviser's office.

Reviser's note: The brackets and enclosed material in the text of the above section occurred in the copy filed by the agency and appear in the Register pursuant to the requirements of RCW 34.08.040.

WSR 92-14-020
EMERGENCY RULES
GAMBLING COMMISSION
[Filed June 22, 1992, 2:15 p.m.]

Date of Adoption: June 12, 1992.
Purpose: To adopt a form for summary suspension actions.

Citation of Existing Rules Affected by this Order: Amending WAC 230-50-580.

Statutory Authority for Adoption: RCW 9.46.0355, 9.46.070(14) and chapter 34.05 RCW.

Pursuant to RCW 34.05.350 the agency for good cause finds that immediate adoption, amendment, or repeal of a rule is necessary for the preservation of the public health, safety, or general welfare, and that observing the time requirements of notice and opportunity to comment upon adoption of a permanent rule would be contrary to the public interest.

Reasons for this Finding: In compliance with APA requirements, chapter 34.05 RCW, this rule provides for completion of summary suspension actions. Due to substantive changes in the new subsection (7), this refiled supercedes [supersedes] emergency filing of February 27, 1992, WSR 92-06-033.

Effective Date of Rule: Immediately.
June 22, 1992
Frank L. Miller
Director

AMENDATORY SECTION (Amending Order 200 [90-13-022], filed 11/27/89 [6/11/90], effective 12/28/89 [7/31/90])

WAC 230-50-580 ADJUDICATED PROCEEDINGS-HEARINGS-FORMS. The following formats shall be utilized in all adjudicated proceedings:

(1) STATE OF WASHINGTON
GAMBLING COMMISSION
In the Matter of the (Suspension/ Revocation/Denial) of the (License/Application) to Conduct Gambling Activities of
Licensee.
NO. \_\_\_\_\_
NOTICE OF ADMINISTRATIVE CHARGES AND OPPORTUNITY FOR AN ADJUDICATED PROCEEDING

(Director's Name) alleges as follows:
I
He is the Director of the Washington State Gambling Commission and makes these charges in his official capacity.

II
Jurisdiction of this proceeding is based on Chapter 9.46 RCW, Gambling, Chapter 34.05 RCW, the Administrative Procedure Act, and Title 230 WAC.

III
\_\_\_\_\_ has been issued the following license(s) by the Washington State Gambling Commission, which license(s) (was/were) issued subject to compliance by the licensee with state laws and rules of the Commission.

- A. License Number \_\_\_\_\_ Authorizing \_\_\_\_\_ Activity
B. License Number \_\_\_\_\_ Authorizing \_\_\_\_\_ Activity
C. License Number \_\_\_\_\_ Authorizing \_\_\_\_\_ Activity

IV
(Attach Recital Of Charges)
(Appropriate Roman Numeral)

The charges specified in paragraphs \_\_\_ through \_\_\_ above constitute grounds for the \_\_\_ day suspension, or revocation of the license(s) held by \_\_\_\_\_ to conduct authorized gambling activity under authority of RCW 9.46.075 and WAC 230-04-400.

(Appropriate Roman Numeral)

The (licensee/applicant) shall be afforded the opportunity to have an Adjudicated Proceeding, which includes a hearing on the alleged violations. In order to commence an Adjudicative Proceeding, the enclosed APPLICATION FOR ADJUDICATED PROCEEDING AND REQUEST FOR HEARING MUST BE COMPLETED IN FULL by the LICENSEE OR REPRESENTATIVE and returned to the Gambling Commission within 20 days from the date of receipt of this notice. FAILURE TO RETURN THIS DOCUMENT WILL RESULT IN THE ENTRY OF A DEFAULT ORDER PURSUANT TO RCW 34.05.440 AND WAC 230-50-010, THE IMPOSITION OF THE PENALTY SET OUT ABOVE OR ONE OF LESSER DEGREE AND SHALL CONSTITUTE A WAIVER OF ANY FURTHER RIGHTS TO A HEARING OR REVIEW IN THIS MATTER.

STATE OF WASHINGTON }
COUNTY OF THURSTON } ss.

(Director's Name), being first duly sworn on oath, deposes and says: That he has read the foregoing Notice of Administrative Charges and Opportunity for Adjudicated Proceeding, knows the contents thereof, and believes the same to be true, and that he is the Director of the Washington State Gambling Commission and in that capacity has executed said Statement of Charges.

(Director's Name)

SUBSCRIBED AND SWORN TO before me this \_\_\_ day of \_\_\_, 19((89))

NOTARY PUBLIC in and for the State of Washington residing at \_\_\_\_\_

(2) STATE OF WASHINGTON GAMBLING COMMISSION

In the Matter of the (Suspension/ Revocation/Denial) of the (License/Application) to Conduct Authorized Gambling Activities of

NO. \_\_\_\_\_

APPLICATION FOR ADJUDICATED PROCEEDING AND REQUEST FOR HEARING

(Licensee/Applicant.)

THIS IS AN IMPORTANT NOTICE WHICH DETERMINES WHETHER OR NOT YOU WILL HAVE THE RIGHT TO A HEARING IN THIS MATTER. PLEASE READ THIS NOTICE CAREFULLY. IF YOU HAVE ANY QUESTIONS REGARDING YOUR LEGAL RIGHTS IN THIS MATTER YOU SHOULD CONTACT AN ATTORNEY.

In order to request and preserve your right to a hearing you MUST complete and sign this form, then return it by mail within 20 days to:

The Washington State Gambling Commission 4511 Woodview Drive SE ((Mail Stop QB-11)) Post Office Box 42400 ((Lacey)) Olympia, Washington 98504-((812+)) 2400

FAILURE TO COMPLETE AND RETURN THIS FORM AS INSTRUCTED WILL RESULT IN THE ENTRY OF A DEFAULT ORDER AGAINST YOU PURSUANT TO RCW 34.05.440, and WAIVER of your rights to appeal in this matter.

YOU HAVE 20 DAYS FROM THE DATE OF RECEIPT OF THIS FORM TO COMPLETE AND RETURN IT TO THE ADDRESS ABOVE.

NO EXTENSIONS BEYOND THE 20 DAYS WILL BE GRANTED.

BRIEF EXPLANATION OF RIGHTS AND PROCEEDINGS:

You have the right to apply for an ADJUDICATIVE PROCEEDING, which includes a hearing on the allegations set forth in the notice of administrative charges. The hearing will be conducted by a state Administrative Law Judge pursuant to state law and administrative

codes. You have the right to be represented by an attorney of your choice and at YOUR OWN EXPENSE.

You have the right to produce witnesses, and evidence relevant to the violations alleged. See WAC 230-50 for additional rights.

You have the right to have an interpreter for the proceedings if you or any witness which you will call is a limited English speaking person OR a hearing impaired person.

In order to request an interpreter, you MUST complete the attached REQUEST FOR INTERPRETER FORM and RETURN IT along with this form to the Gambling Commission. THIS SERVICE IS FREE OF CHARGE.

INSTRUCTIONS - Place a check mark and your signature next to the statement which describes your request(s) in this matter.

Check Mark Signature

- 1) I want to have a hearing in this Adjudicated Proceeding
2) I will be represented by an attorney in this matter, his/her name, address and phone number are as follows: Name Address Phone Number
3) I will NOT be represented by an attorney in this matter.
4) I DO NOT want a HEARING AND WAIVE MY RIGHTS TO A HEARING IN THIS MATTER.

Please indicate those charges, if any, which you admit occurred.

You may attach a letter or a statement of your position in this matter if you choose to do so. Please indicate whether or not you attached either.

I attached a letter or statement
I did NOT attach a letter or statement

A HEARING, if requested, shall be conducted by a state Administrative Law Judge in a location near your place of business or residence, but not necessarily in the city or county in which you do business or reside. You will be notified at least seven (7) days in advance of the proceeding.

If you do not understand any portion of these documents, you are strongly encouraged to contact an attorney.

You MUST complete, sign, date and then mail this document together with the REQUEST FOR INTERPRETER form, to the Washington State Gambling Commission at the address as stated on this form WITHIN 20 days of receipt of these documents. FAILURE TO DO SO WILL RESULT IN A WAIVER OF YOUR RIGHTS TO A HEARING IN THIS MATTER AND ENTRY OF A DEFAULT ORDER PURSUANT TO RCW 34.05.440 AND WAC 230-50-010.

Dated this \_\_\_ day of \_\_\_, 19((89))

\*\*SIGN HERE\*\* LICENSEE OR REPRESENTATIVE

(3) STATE OF WASHINGTON GAMBLING COMMISSION

In the Matter of the (Suspension/ Revocation/Denial) of the (License/Application) to Conduct Authorized Gambling Activities of

NO. \_\_\_\_\_

(Licensee/Applicant)

APPLICATION FOR AN ADJUDICATED PROCEEDING AND REQUEST FOR HEARING WITH OFFER OF SETTLEMENT

THIS IS AN IMPORTANT NOTICE WHICH DETERMINES WHETHER OR NOT YOU WILL HAVE THE RIGHT TO A

HEARING IN THIS MATTER. PLEASE READ THIS NOTICE CAREFULLY. IF YOU HAVE ANY QUESTIONS REGARDING YOUR LEGAL RIGHTS IN THIS MATTER YOU SHOULD CONTACT AN ATTORNEY.

In order to request and preserve your right to a hearing you MUST complete and sign this form, then return it by mail within 20 days to:

The Washington State Gambling Commission
Post Office Box 42400
4511 Woodview Drive SE ((Mail Stop 0B-11))
((Lacey)) Olympia, Washington ((98504-8121)) 98504-2400

FAILURE TO COMPLETE AND RETURN THIS FORM AS INSTRUCTED WILL RESULT IN THE ENTRY OF A DEFAULT ORDER AGAINST YOU PURSUANT TO RCW 34.05.440, and WAIVER of your rights to appeal in this matter.

YOU HAVE 20 DAYS FROM THE DATE OF RECEIPT OF THIS FORM TO COMPLETE AND RETURN IT TO THE ADDRESS ABOVE.

NO EXTENSIONS BEYOND THE 20 DAYS WILL BE GRANTED.

BRIEF EXPLANATION OF RIGHTS AND PROCEEDINGS:

You have the right to apply for an ADJUDICATIVE PROCEEDING which includes a hearing on the allegations set forth in the notice of administrative charges. The hearing will be conducted by a state Administrative Law Judge pursuant to state law and administrative codes. You have the right to be represented by an attorney of your choice and at YOUR OWN EXPENSE.

You have the right to produce witnesses, and evidence relevant to the violations alleged. See WAC 230-50 for additional rights.

You have the right to have an interpreter for the proceedings if you or any witness which you will call is a limited English speaking person OR a hearing impaired person.

In order to request an interpreter, you MUST complete the attached REQUEST FOR INTERPRETER FORM and RETURN IT along with this form to the Gambling Commission. THIS SERVICE IS FREE OF CHARGE.

INSTRUCTIONS - Place a check mark and your signature next to the statement which describes your request(s) in this matter.

- Check Mark Signature
1) I WANT TO HAVE A HEARING IN THIS ADJUDICATED PROCEEDING
2) I will be represented by an attorney in this matter, his/her name, address and phone number are as follows:
Name
Address
Phone Number
3) I will NOT be represented by an attorney in this matter.
4) I DO NOT want a HEARING AND WAIVE MY RIGHTS TO A HEARING IN THIS MATTER.
5) I will agree to a stipulated settlement as stated on Page 3 and have signed the order on page 4

Please indicate those charges, if any, which you admit occurred.

You may attach a letter or a statement of your position in this matter if you choose to do so. Please indicate whether or not you attached either.

I attached a letter or statement
I did NOT attach a letter or statement

A hearing, if requested, shall be conducted by a state Administrative Law Judge in a location near your place of business or residence, but not necessarily in the city or county in which you do business or reside. You will be notified at least seven (7) days in advance of the proceeding.

If you do not understand any portion of these documents, you are strongly encouraged to contact an attorney.

You MUST complete, sign, date and then mail this document together with the REQUEST FOR INTERPRETER form, to the Washington State Gambling Commission at the address as stated on this form WITHIN 20 days of receipt of these documents. FAILURE TO DO SO WILL RESULT IN A WAIVER OF YOUR RIGHTS TO A HEARING IN THIS ADJUDICATIVE PROCEEDING AND ENTRY OF A DEFAULT ORDER PURSUANT TO RCW 34.05.440 AND WAC 230-50-010.

Dated this \_\_\_ day of \_\_\_, 19((89)) \_\_

\*\*SIGN HERE\*\*
LICENSEE OR REPRESENTATIVE

I will agree to a stipulated settlement in this matter and the entry of the attached order on the following terms:

- A suspension of \_\_\_ days for my \_\_\_ gambling license(s).
A fine of \_\_\_ in lieu of the \_\_\_ day suspension of my \_\_\_ gambling license(s).

The order finds that the violation(s) were in fact committed.

The dates for the suspension or fine will be as stated in the order. (Insert name of commission staff member) of the staff of the Commission can be contacted regarding changing the dates for the suspension and/or payment of the fine before the order is signed.

The dates of the suspension as set are no more than 90 calendar days from the date of mailing of this form to you and the fine is due PRIOR to the dates of the suspension.

By signing as indicated I agree to this settlement.

\*\*SIGN HERE\*\*
LICENSEE OR REPRESENTATIVE
DATE

YOU MUST ALSO SIGN THE ORDER ON PAGE FOUR WHERE INDICATED.

(4)

STATE OF WASHINGTON GAMBLING COMMISSION

An Adjudicated proceeding in the matter of the Suspension or Revocation of the license(s) to conduct Gambling Activities of:
No.
Stipulated Settlement from Written Pre Hearing Offer

(( ))
Licensee

I

The licensee named hereon stipulates that the charges as set forth in the statement of charges attached hereto occurred and agrees to entry of a finding as such and conclusion of law or the violations.

If

That (Licensee's Name) has been issued (a) license(s) to conduct gambling activity(ies), as follows:

License Number Authorizing
(Insert License #) (Type of Activity)
(Insert License #) (Type of Activity)
(Insert License #) (Type of Activity)

III

That the following is entered as the Final Order on these charges.

That the license(s) of (Licensees Name) to conduct (Type of activity) activity(ies) is hereby suspended for a term of ( ) days commencing (date suspension to start) and running through and including (date suspension will end). Provided further, that in lieu of said suspension the licensee may pay a fine of (\$ amount) on or before (Date).

Signed and dated this \_\_\_ day of \_\_\_, 19(90.) \_\_\_

(Name)
Administrative Law Judge

(Licensee) or representative

(Asst. Attorney General)

(5)

STATE OF WASHINGTON
GAMBLING COMMISSION

An Adjudicated Proceeding In the Matter of the (Suspension/Revocation/Denial) of the (License/Application) to Conduct Authorized Gambling Activities of (Licensee/Applicant).

NO.
NOTICE OF HEARING

I

(ATTACH RECITAL OF CHARGES)

II

That the licensee(s) (was/were) previously notified of the administrative charges pending and (has/have) made a timely application for adjudicated proceeding and request for hearing. Based upon that request, a hearing will be conducted by Administrative Law Judge of phone number on all charges as stated pursuant to WAC 230-50-010.

III

That the agency will be represented at the hearing by Assistant Attorney General of phone number. The licensee will be represented by of phone number.

IV

That the hearing is set for at the hour of in the city of at. The hearing is being conducted under the authority of chapter 9.46 RCW and amendments thereto, and will be conducted pursuant to chapter 34.05 RCW and 230-50 WAC. Should the licensee and representatives fail to appear at the hearing as scheduled a default order pursuant to RCW 34.05.440 will be entered.

The proceeding will determine whether a suspension/revocation/or denial should be imposed.

(Director's Name)

(6)

STATE OF WASHINGTON
GAMBLING COMMISSION

An Adjudicated Proceeding In the Matter of the (Suspension/Revocation/Denial) of the (License/Application) to Conduct Gambling Activities of:

No.

Licensee.

REQUEST FOR INTERPRETER AND/OR TRANSLATION OF DOCUMENTS

I, being a party in this proceeding hereby state that I am a limited English speaking person or hearing impaired person or that I will be calling a witness who is a limited English speaking or hearing impaired person and that (I/they) require an interpreter as indicated below:

(Check all items that apply and fill in the blank spaces.)

- I will require an interpreter for the language.
I will require an interpreter for a hearing impairment.
I will be calling a limited English speaking witness who will require an interpreter in the language.
I will be calling a hearing impaired person who will require an interpreter.
I request all documents in this proceeding be translated into the language.

Signed:
Dated:

STATE OF WASHINGTON
GAMBLING COMMISSION

In the Matter of the Summary Suspension of the License to Operate Gambling Activities of:

No.

FINDINGS, CONCLUSIONS, AND ORDER OF SUMMARY SUSPENSION OF LICENSES

(Licensee's Name)
Licensee.

Pursuant to RCW 34.05.422(4), the Commission may summarily suspend a license pending proceedings for revocation or other action. The Commission has authorized the Director to summarily suspend a license pursuant to WAC 230-50-012. This matter then having been brought before the Director for a summary disposition pursuant to this authority on (date), and the Director acting pursuant to this authority has issued this order and caused it to be served upon the licensee. The order contained herein shall be deemed effective immediately upon its service to the licensee, authorized representative, or agent thereof, unless otherwise specified herein. By this authority, an authorized agent of the Commission shall under the terms hereof seize all current licenses authorizing gambling activity and all such gambling activity shall cease as ordered herein.

FINDINGS OF FACT

I

That (director's name) is the Director of the Washington State Gambling Commission and issues this order in that capacity.

II

That (licensee's name) has been issued (a) license(s) to operate the following authorized gambling activity(ies):

Table with 3 columns: License Number 211-, Authorizing, Activity

Which license(s) (was/were) issued subject to compliance with all of the applicable statutes and regulations governing gambling activities.

III

After a thorough review of the affidavit(s) of the special agent(s) of the Commission concerning the facts in this matter, which are attached hereto and labelled as Attachment(s) (list), the Director accepts (this/these) as a verity and makes the determination that the action as ordered herein is warranted.

IV

(State charge)

That the violation(s) as stated require the immediate cessation of the gambling activity in that the safety and welfare of the public is affected as follows: (State reason(s) affected from WAC 230-50-012 (2)(a) - (k), as applicable)

CONCLUSIONS OF LAW

I

Based on the foregoing Findings of Fact, the Director, (director's name), makes the following CONCLUSIONS:

II

(select from WAC 230-50-012 (2)(a) - (k), as applicable)

III

That the circumstances as set forth in paragraph(s) . . . . . through . . . . . above constitute grounds for the suspension or revocation of the license(s) issued by the Washington State Gambling Commission under RCW 9.46.075 and WAC 230-04-400, and further constitute an immediate danger to the public safety and welfare.

IV

Immediate cessation of the licensed or permitted activities by the licensee or permittee is necessary for the protection or preservation of the welfare of the community within which these activities are being conducted.

V

(director's name), Director, has the authority pursuant to WAC 230-50-012 to issue the following ORDER:

ORDER

Based upon the foregoing FINDINGS OF FACT AND CONCLUSIONS, it is the ORDER of the undersigned Director, pursuant to authority granted to him by RCW 34.05.422 and WAC 230-50-012, that the license of (licensee's name) to operate [type(s) of activity] within the state of Washington is hereby suspended pending a formal hearing by an Administrative Law Judge or the Commission for suspension or revocation of said license, said suspension or revocation to be effective (immediately) [as of (date), at (time)].

STATEMENT OF RIGHTS

(1) You have a right to a prompt hearing on this matter. You may request a hearing by completing and returning to the Commission the enclosed Application for Adjudicated Proceeding and Request for Hearing. Failure to submit the Application for Adjudicated Proceeding and Request for Hearing form within twenty (20) days of service of this order upon you shall result in a waiver of your right to an adjudicated proceeding and entry of an order in default under RCW 34.05.440. If a timely application for a hearing is received, a hearing shall be conducted not sooner than seven (7) days nor later than 90 days from the date of service of this Order unless otherwise agreed to by the parties: PROVIDED, That you may waive the seven (7) day notice rule of WAC 230-50-030(2) and request a hearing at an earlier date.

(2) You have a right to petition for a stay of this order. You may request a stay by filing a written request with the Commission. Any request for a stay must be received by the Commission within fifteen (15) days of service of this order upon you. If a timely request for a stay is received by the Commission, a hearing regarding a request for stay will be conducted in accordance with WAC 230-50-015. A request for a stay does not constitute a request for a hearing as provided in paragraph (1) of this Statement of Rights.

DATED this \_\_\_\_ day of \_\_\_\_\_, 199 .

(director's name)
Director

STATE OF WASHINGTON }
COUNTY OF THURSTON } ss.

(director's name), being first duly sworn on oath, deposes and says: That he has read the foregoing Order of Summary Suspension of License and Notice of Hearing, knows the contents thereof, and believes the same to be true, and that he is the duly appointed and qualified Director of the Washington State Gambling Commission and in that capacity has executed said Order of Summary Suspension of the License and Notice of Hearing.

(director's name)
Director

SUBSCRIBED AND SWORN to before me this
day of \_\_\_\_\_, 199 .

NOTARY PUBLIC in and for
the State of Washington
residing at \_\_\_\_\_

Reviser's note: The bracketed material preceding the section above was supplied by the code reviser's office.

Reviser's note: The brackets and enclosed material in the text of the above section occurred in the copy filed by the agency and appear in the Register pursuant to the requirements of RCW 34.08.040.

WSR 92-14-048
EMERGENCY RULES
GREEN RIVER
COMMUNITY COLLEGE
[Filed June 25, 1992, 9:45 a.m.]

Date of Adoption: Emergency adoption by the Green River Community College board of trustees on June 18, 1992.

Purpose: Green River Community College as an institution of society must maintain conditions conducive to the effective performance of its functions. Consequently, Green River Community College has special expectations regarding the conduct of students. Student conduct that detracts from, or interferes with, the accomplishment of college purposes is not acceptable.

Citation of Existing Rules Affected by this Order: Repealing chapter 132J-120 WAC, Student body rights and responsibilities; and amending WAC 132J-108-020 and 132J-108-050.

Statutory Authority for Adoption: RCW 28B.50.140(13).

Pursuant to RCW 34.05.350 the agency for good cause finds that immediate adoption, amendment, or repeal of a rule is necessary for the preservation of the public health, safety, or general welfare, and that observing the time requirements of notice and opportunity to comment upon adoption of a permanent rule would be contrary to the public interest.

Reasons for this Finding: The Green River Community College student code of conduct has been revised to include changes in the laws of the state of Washington. The laws relate to adjudicative processes and the need to clarify and update provisions within the code.

Effective Date of Rule: Immediately.

June 22, 1992
Michael H. McIntyre
Vice-President for Marketing
and Student Development

GREEN RIVER COMMUNITY COLLEGE
RULES OF STUDENT CONDUCT

SECTION I
INTRODUCTION

- WAC 132J-125-010 PURPOSE
WAC 132J-125-020 DEFINITIONS
WAC 132J-125-030 JURISDICTION

SECTION II
NONACADEMIC RIGHTS AND RESPONSIBILITIES

- WAC 132J-125-055 RIGHT TO DEMAND IDENTIFICATION
WAC 132J-125-060 FREEDOM OF EXPRESSION
WAC 132J-125-065 RIGHT TO ASSEMBLY
WAC 132J-125-070 RIGHT TO OUTSIDE SPEAKERS
WAC 132J-125-075 RIGHT TO SALE OF PERSONAL PROPERTY
WAC 132J-125-080 DISTRIBUTION OF MATERIALS

- WAC 132J-125-085 DENIAL OF ACCESS TO GREEN RIVER COMM. COLLEGE
- WAC 132J-125-090 TRESPASS
- WAC 132J-125-095 SMOKING
- WAC 132J-125-100 LIQUOR
- WAC 132J-125-105 DRUGS/SUBSTANCE ABUSE
- WAC 132J-125-110 CONDUCT AT COLLEGE FUNCTIONS
- WAC 132J-125-115 THEFT; STOLEN PROPERTY; ROBBERY
- WAC 132J-125-120 DAMAGING PROPERTY
- WAC 132J-125-125 INTERFERENCE; INTIMIDATION
- WAC 132J-125-130 OFFENSIVE LANGUAGE
- WAC 132J-125-135 SEXUAL HARASSMENT
- WAC 132J-125-140 FORGERY OR ALTERATION OF RECORDS
- WAC 132J-125-145 COMPUTER TRESPASS
- WAC 132J-125-150 FIREARMS/EXPLOSIVES
- WAC 132J-125-155 OTHER PUNISHABLE ACTS
- WAC 132J-125-160 INITIATION AND TYPES OF NONACADEMIC DISCIPLINE
- WAC 132J-125-165 APPEAL OF NONACADEMIC DISCIPLINE
- WAC 132J-125-170 COLLEGE DISCIPLINARY BOARD

SECTION III

ACADEMIC RESPONSIBILITIES AND RIGHTS

- WAC 132J-125-180 ACADEMIC RESPONSIBILITIES
- WAC 132J-125-190 STUDENT ACADEMIC RIGHTS
- WAC 132J-125-200 PLAGIARISM/CHEATING
- WAC 132J-125-210 CLASSROOM CONDUCT
- WAC 132J-125-220 INITIATION OF ACADEMIC DISCIPLINE
- WAC 132J-125-230 STUDENT ACADEMIC GRIEVANCE
- WAC 132J-125-240 APPEAL OF ACADEMIC DISCIPLINE; FILING OF ACADEMIC GRIEVANCE
- WAC 132J-125-250 COLLEGE ACADEMIC BOARD

SECTION IV

DISCIPLINE/GRIEVANCE ADJUDICATIONS

- WAC 132J-125-260 DISCIPLINE AND GRIEVANCE—TYPE OF ADJUDICATIVE PROCEEDING
- WAC 132J-125-270 DISCIPLINE AND GRIEVANCE—PROCEEDINGS GENERALLY
- WAC 132J-125-280 DISCIPLINE AND GRIEVANCE—REGULAR ADJUDICATIVE PROCEEDINGS
- WAC 132J-125-290 DISCIPLINE AND GRIEVANCE—BRIEF ADJUDICATIVE PROCEEDINGS
- WAC 132J-125-300 SUMMARY SUSPENSION OR REMOVAL
- WAC 132J-125-310 RECORD-KEEPING

AMENDMENTS

- WAC 132J-108-020 APPOINTMENT OF PRESIDING OFFICERS
- WAC 132J-108-050 BRIEF ADJUDICATIVE PROCEDURES

REPEALER

- WAC 132J-120. STUDENT BODY RIGHTS AND RESPONSIBILITIES

RULES OF STUDENT CONDUCT

SECTION I

INTRODUCTION

[NEW SECTION]

WAC 132J-125-010 PURPOSE (1) Green River Community College, an agency of the state of Washington, provides a variety of educational opportunities for students, namely the opportunities to examine the academic, vocational, technical, cultural, social and recreational aspects of society. Green River Community College as an institution of society must maintain conditions conducive to the effective performance of its functions. Consequently, Green River Community College

has special expectations regarding the conduct of students. Student conduct that detracts from, or interferes with, the accomplishment of college purposes is not acceptable.

(2) The student is, first of all, a member of the community at large, and as such has the rights and responsibilities of any citizen. In addition, admission to Green River Community College carries with it the presumption that students will conduct themselves as responsible members of the college community. This includes an expectation that students will obey the law, will comply with rules and regulations of the college, will maintain a high standard of integrity and honesty, and will respect the rights, privileges and property of other members of the college community.

(3) The following rules regarding the conduct of students are adopted in order to provide students a full understanding of the rules that will enable the college to maintain conditions conducive to the effective performance of the college's functions. Sanctions for violations of the rules of student conduct will be administered by the college in the manner provided by said rules. When violations of laws of the state of Washington and/or the United States are also involved, the college may refer such matters to the appropriate authorities. In cases of minors, this conduct may also be referred to parents or legal guardians.

Reviser's note: The bracketed material preceding the section above was supplied by the code reviser's office:

[NEW SECTION]

WAC 132J-125-020 DEFINITIONS As used in this chapter, unless the context requires otherwise:

(1) "Administration" and "administrator" include the president, assistant(s) to the president, vice presidents, deans, directors of programs or functions, and everyone else designated as a member of the administration by the board of trustees.

(2) "Arbitrary or capricious" refers to willful or unreasonable action, taken without consideration of, or in disregard of, facts or circumstances of a particular case. Where there is room for two reasonable opinions, an action shall not be deemed to be arbitrary or capricious when taken honestly and upon due consideration, however much it may be believed that an erroneous conclusion has been reached.

(3) "Assembly" means any overt activity engaged in by two or more persons, the object of which is to gain publicity, advocate a view, petition for a cause, or disseminate information to any person, persons, or group of persons.

(4) "College" means the institution(s) operated by the board of trustees of the district.

(5) "College community" is composed of all individuals who are enrolled in classes and/or employed by the college.

(6) "College facilities" and "college facility" mean and include any and all real and personal property owned, rented, leased or operated by the board of trustees of Washington State Community College District

10, and shall include all buildings and appurtenances attached thereto and all parking lots and other grounds.

(7) "Designee" means a person appointed in writing by an officer or other person designated in a rule to perform a function, to perform that function on the appointer's behalf.

(8) "Disciplinary action" and "discipline" shall mean and include reprimand, probation, suspension, dismissal, monetary fine, restitution, and any other action taken against a student as a sanction or penalty for violation of a designated rule of student conduct.

(9) "District" means Washington State Community College District 10.

(10) "Faculty member" and "instructor" mean any employee of Washington Community College District 10 who is employed on a full or part-time basis as a teacher, instructor, counselor or librarian.

(11) "President" is the chief executive officer of the college appointed by the board of trustees.

(12) "Recognized student organization" means the organization established by and operated pursuant to the Constitution of the Associated Students of Green River Community College.

(13) "Rules of student conduct" shall mean those rules regulating student conduct as herein adopted.

(14) "Service," "serve," "filing" and "file" shall have the meanings in WAC 10-08-110.

(15) "Student" is any person who is enrolled for classes or is formally in the process of applying for admission to the college.

(16) The singular includes the plural and vice versa, the masculine includes the feminine and vice versa, and the disjunctive includes the conjunctive and vice versa.

**Reviser's note:** The bracketed material preceding the section above was supplied by the code reviser's office.

#### [NEW SECTION]

**WAC 132J-125-030 JURISDICTION** This chapter shall apply to students and student conduct which occurs (1) on or in a college facility or (2) whenever a student is present at or engaged in any college-sponsored program or function. This chapter is not exclusive, and where conduct becomes known which may also violate any other rule or provision of law, nothing herein shall limit the right or duty of any person to report elsewhere or seek another remedy for that conduct.

**Reviser's note:** The bracketed material preceding the section above was supplied by the code reviser's office.

### SECTION II NONACADEMIC RIGHTS AND RESPONSIBILITIES

#### [NEW SECTION]

**WAC 132J-125-055 RIGHT TO DEMAND IDENTIFICATION** (1) For the purpose of determining identity of a person as a student, any faculty member, college administrator, or designee of the president may demand that any person produce evidence of student enrollment at the college. Presenting a current student identification card with a picture I.D. card will be deemed proof of student status.

(2) Refusal by a student to produce identification as required shall be cause for disciplinary action.

**Reviser's note:** The bracketed material preceding the section above was supplied by the code reviser's office.

#### [NEW SECTION]

**WAC 132J-125-060 FREEDOM OF EXPRESSION** The right of free speech is fundamental to the democratic process. Students and other members of the college community shall be free to express their views or support causes by orderly means which do not disrupt the regular and essential operations of the college.

**Reviser's note:** The bracketed material preceding the section above was supplied by the code reviser's office.

#### [NEW SECTION]

**WAC 132J-125-065 RIGHT TO ASSEMBLY** (1) Students shall have the right of "assembly" upon college facilities that are generally available to the public. Such assembly shall:

- (a) Be conducted in an orderly manner,
- (b) Not unreasonably interfere with vehicular or pedestrian traffic,
- (c) Not unreasonably interfere with classes, schedules, meetings or ceremonies, and
- (d) Not unreasonably interfere with the regular activities of the college.

(2) A student who conducts or participates in an assembly in a manner which causes or helps to cause a violation of this section shall be subject to discipline.

(3) All speakers at an assembly shall allow time, insofar as circumstances reasonably permit, for a question and answer session.

(4) Sound amplifying equipment shall not be used without permission of the college president or president's designee.

**Reviser's note:** The bracketed material preceding the section above was supplied by the code reviser's office.

#### [NEW SECTION]

**WAC 132J-125-070 RIGHT TO OUTSIDE SPEAKERS** (1) Any recognized student organization, after written notification to the dean for student programs as prescribed herein, may invite a speaker to the college, subject to any restraints imposed by law.

(2) The appearance of an invited speaker at the college does not represent an endorsement, either implicit or explicit, by the college.

(3) The scheduling of facilities for hearing invited speakers shall be made through the college conference and scheduling office.

(4) The dean for student programs must be notified in writing at least four academic days prior to the appearance of an invited speaker. Notification shall include time, location and sponsoring organization. An exception to the four day notification requirement may be made by the dean for student programs or the vice president for marketing and student development.

(5) All speakers shall allow time, insofar as circumstances reasonably permit, for a question and answer session.

**Reviser's note:** The bracketed material preceding the section above was supplied by the code reviser's office.

**[NEW SECTION]**

**WAC 132J-125-075 RIGHT TO SALE OF PERSONAL PROPERTY** (1) Students have the right to engage in legal, incidental sales of personal property in private transactions.

(2) All other sales shall take place in Lindbloom Student Center subject to the approval and requirements of the dean for student programs or designee.

**Reviser's note:** The bracketed material preceding the section above was supplied by the code reviser's office.

**[NEW SECTION]**

**WAC 132J-125-080 DISTRIBUTION OF MATERIALS** (1) Handbills, leaflets, newspapers and similar materials may be distributed free of charge upon college facilities designated by the dean for student programs, provided that such distribution does not interfere with the ingress and egress of persons or interfere with the free flow of vehicle or pedestrian traffic.

(2) All students and nonstudents shall register with the dean for student programs prior to distributing any handbill, leaflet, newspaper or related matter, including, but not limited to, materials to be posted on college bulletin boards.

(3) The distribution of materials is prohibited in parking areas.

(4) All handbills, leaflets, newspapers and similar materials should identify the publisher and the distributing organization or individual.

(5) Distribution by means of accosting individuals or unreasonably disruptive behavior is prohibited.

(6) Any student who violates any provision of this rule relating to the distribution and sale of handbills, leaflets, newspapers or similar materials shall be subject to discipline.

(7) Any distribution of the materials regulated in this section shall not be construed as approval of the same by the college.

**Reviser's note:** The bracketed material preceding the section above was supplied by the code reviser's office.

**[NEW SECTION]**

**WAC 132J-125-085 DENIAL OF ACCESS TO GREEN RIVER COMMUNITY COLLEGE** (1) The vice president for marketing and student development may deny admission to a prospective student, or continued attendance to an enrolled student, if it reasonably appears that the student would not be competent to profit from the curriculum offerings of the college, or would, by the student's presence or conduct, create a disruptive atmosphere within the college or a substantial risk of actual harm to a member of the campus community.

(2) Denial of access decisions may be appealed, as or like disciplinary actions, to the disciplinary board or academic board, whichever is designated by the vice president for marketing and student development.

**Reviser's note:** The bracketed material preceding the section above was supplied by the code reviser's office.

**[NEW SECTION]**

**WAC 132J-125-090 TRESPASS** (1) In the instance of any event that the vice president for marketing and student development or designee deems to be disruptive of order, or deems to impede the movement of persons or vehicles, or deems to disrupt or threaten to disrupt the ingress or egress of persons from college facilities, the vice president for marketing and student development or designee is authorized to:

(a) Prohibit the entry of any person, or withdraw from any person the license or permission to enter onto or remain, upon any portion of a college facility;

(b) Give notice against trespass to any person from whom the license or permission has been withdrawn or who has been prohibited from entering onto or remaining upon all or any portion of a college facility;

(c) Order any person to leave or vacate all or any portion of a college facility.

(2) Any student who disobeys a lawful order given by the vice president or designee pursuant to subsection (1) shall be subject to discipline.

**Reviser's note:** The bracketed material preceding the section above was supplied by the code reviser's office.

**[NEW SECTION]**

**WAC 132J-125-095 SMOKING** Smoking in college buildings and in areas of the campus not specifically posted by the administration as open for smoking is not permitted. Violations of this section shall be cause for discipline.

**Reviser's note:** The bracketed material preceding the section above was supplied by the code reviser's office.

**[NEW SECTION]**

**WAC 132J-125-100 LIQUOR** Any student who, while in any college facility or participating in a college-related program, uses, possesses, consumes, is demonstrably under the influence of, or sells any liquor as defined in RCW 66.04.010, in violation of law or in a manner which significantly disrupts a college activity, shall be subject to discipline.

**Reviser's note:** The bracketed material preceding the section above was supplied by the code reviser's office.

**[NEW SECTION]**

**WAC 132J-125-105 DRUGS/SUBSTANCE ABUSE** Any student who, while in any college facility or participating in a college-related program, uses, possesses, consumes, is demonstrably under the influence of, or sells any narcotic drug or controlled substance as defined in RCW 69.50.101, in violation of law or in a manner which significantly disrupts a college activity, shall be subject to discipline. For purposes of this section, "sell" includes the statutory meaning in RCW 69.50.410.

**Reviser's note:** The bracketed material preceding the section above was supplied by the code reviser's office.



**[NEW SECTION]**

**WAC 132J-125-110 CONDUCT AT COLLEGE FUNCTIONS** Any student who significantly disrupts any college function by intentionally engaging in conduct that renders it difficult or impossible to continue such a function in an orderly manner, shall be subject to discipline. A college function for this purpose includes, but is not limited to, any disciplinary, grievance, or appeal meeting or hearing under these rules.

**Reviser's note:** The bracketed material preceding the section above was supplied by the code reviser's office.

**[NEW SECTION]**

**WAC 132J-125-115 THEFT; STOLEN PROPERTY; ROBBERY** Any student who, while in any college facility or participating in a college-related program, commits theft as defined in RCW 9A.56.020, or possesses stolen property as defined in RCW 9A.56.140, or commits robbery as defined in RCW 9A.56.190, shall be subject to discipline.

**Reviser's note:** The bracketed material preceding the section above was supplied by the code reviser's office.

**[NEW SECTION]**

**WAC 132J-125-120 DAMAGING PROPERTY** (1) Any student who causes or attempts to cause physical damage to property owned, controlled or operated by the district, or to property owned, controlled or operated by another person while said property is located on college facilities, shall be subject to discipline.

(2) Any student who in this or any other manner is guilty of malicious mischief in violation of RCW 9A.48.070 through 9A.48.100 shall be subject to discipline.

**Reviser's note:** The bracketed material preceding the section above was supplied by the code reviser's office.

**[NEW SECTION]**

**WAC 132J-125-125 INTERFERENCE; INTIMIDATION** Any student who, while in any college facility or participating in a college-related program, shall interfere by force or violence with, or intimidate by threat of force or violence, another person who is in the peaceful discharge or conduct of his/her duties or studies, in the manner prohibited by RCW 28B.10.570 or 28B.10.571, shall be subject to discipline.

**Reviser's note:** The bracketed material preceding the section above was supplied by the code reviser's office.

**[NEW SECTION]**

**WAC 132J-125-130 OFFENSIVE LANGUAGE** Any student who, while in any college facility or participating in a college-related program, and without a privilege to do so, uses language which he/she knows or should know is offensive to a reasonable person, shall be subject to discipline.

**Reviser's note:** The bracketed material preceding the section above was supplied by the code reviser's office.

**[NEW SECTION]**

**WAC 132J-125-135 SEXUAL HARASSMENT** Any student who, while in any college facility or participating in a college-related program, knowingly engages in unwelcome sexual advances, requests for sexual favors, and other verbal or physical conduct of a sexual nature, where such behavior offends the recipient, causes discomfort or humiliation, or interferes with job or academic performance, shall be subject to discipline.

**Reviser's note:** The bracketed material preceding the section above was supplied by the code reviser's office.

**[NEW SECTION]**

**WAC 132J-125-140 FORGERY OR ALTERATION OF RECORDS** Any student who, while in any college facility or participating in a college-related program, engages in forgery, as defined in RCW 9A.60.020, shall be subject to discipline.

**Reviser's note:** The bracketed material preceding the section above was supplied by the code reviser's office.

**[NEW SECTION]**

**WAC 132J-125-145 COMPUTER TRESPASS** Any student who, without authorization, intentionally gains access to a computer system or electronic data of another student, a faculty member or the district, in violation of RCW 9A.52.110 through 9A.52.130, shall be subject to discipline.

**Reviser's note:** The bracketed material preceding the section above was supplied by the code reviser's office.

**[NEW SECTION]**

**WAC 132J-125-150 FIREARMS/EXPLOSIVES** Any student who, while in any college facility or participating in a college-related program, uses or has on his/her person firearms or explosive materials, without written permission of the vice president for marketing and student development or vice president's designee, shall be subject to discipline.

**Reviser's note:** The bracketed material preceding the section above was supplied by the code reviser's office.

**[NEW SECTION]**

**WAC 132J-125-155 OTHER PUNISHABLE ACTS** Any student who, while in any college facility or participating in a college-related program, commits any other act which is a crime under the laws of the state of Washington or the United States and which act does not otherwise violate a rule of student conduct, shall be subject to discipline.

**Reviser's note:** The bracketed material preceding the section above was supplied by the code reviser's office.

**[NEW SECTION]**

**WAC 132J-125-160 INITIATION AND TYPES OF NONACADEMIC DISCIPLINE** (1) Any college administrator, except the president or a member of the disciplinary board, may take either of the following disciplinary actions against a student, for causes other than cheating or classroom misconduct:

(a) **Warning:** An oral or written notice to a student that college expectations about conduct have not been met;

(b) **Reprimand:** A written notice, designated as a reprimand, which censures a student for improper conduct and includes a warning that continuation or repetition of improper conduct may result in other, further discipline.

(2) A copy of any written warning or reprimand should be provided to the vice president for marketing and student development.

(3) The vice president for marketing and student development, or designee, after meeting or attempting to meet with the student to advise of the potential violation and penalties, may issue a warning or reprimand or take any of the following disciplinary actions against a student, for causes other than cheating or classroom misconduct:

(a) **Probation:** A written statement placing specific conditions upon the student's continued attendance at the college, for a stated period of time not exceeding termination of the student's enrollment. Violation of any such condition shall be cause for further disciplinary action;

(b) **Suspension or Dismissal:** Written termination of status as a student at the college, for a period of time that is limited (suspension) or indefinite or open-ended (dismissal). The written notice should indicate any condition(s) for readmission, and that written application for readmission must be made to the vice president for marketing and student development. Upon receipt of such an application, with justification deemed adequate by that vice president, the student may be readmitted. No fees will be refunded for the quarter in which the action is taken;

(c) **Monetary fine or restitution:** A written order, alone or combined with another disciplinary action, requiring the student to pay, within a stated time limit, appropriate restitution for a financial loss caused by the student's misconduct and/or a monetary fine not exceeding one quarter's tuition. Failure to pay shall be cause for further disciplinary action and/or cancelling and barring the student's registration.

(4) Any written notice of disciplinary action under this rule (a) shall be either delivered personally or mailed by first class mail to the student's last known address, within sixty academic days after the later of the student misconduct or the date the misconduct was discovered or should have been discovered, and (b) shall advise the student of his/her right to appeal under these rules.

**Reviser's note:** The bracketed material preceding the section above was supplied by the code reviser's office.

#### [NEW SECTION]

**WAC 132J-125-165 APPEAL OF NONACADEMIC DISCIPLINE** A student may appeal a nonacademic disciplinary action by filing with the vice president for marketing and student development, within twenty days after the earlier of personal delivery or mailing of notice of the disciplinary action, a written application for an adjudicative proceeding conducted by the disciplinary

board. The vice president or designee has discretion to extend this deadline for good cause.

**Reviser's note:** The bracketed material preceding the section above was supplied by the code reviser's office.

#### [NEW SECTION]

**WAC 132J-125-170 COLLEGE DISCIPLINARY BOARD** (1) The Green River Community College Disciplinary Board is hereby established. The purpose of the disciplinary board is to provide a student with an opportunity to be heard by an independent body with regard to nonacademic discipline.

(2) The disciplinary board shall be composed of five members, who should be chosen no later than November first of each academic year. The board members shall be selected as follows:

(a) The recognized faculty organization shall appoint one member and an alternate; each such person shall serve a two-year term, which shall automatically be extended until his/her successor is appointed.

(b) The president of the recognized student organization shall appoint two members and an alternate; each such person shall serve a one-year term, which shall automatically be extended until a successor is appointed.

(c) The college president shall appoint one member and an alternate from the college administration, neither of them being the vice president for marketing and student development, who shall serve at the pleasure of the president.

(d) The chairperson of the board shall be the person functioning as dean of educational planning or his/her designee; if that dean is disqualified from serving, the chairperson shall be the person functioning as dean of student programs or his/her designee.

**Reviser's note:** The bracketed material preceding the section above was supplied by the code reviser's office.

### SECTION III ACADEMIC RESPONSIBILITIES AND RIGHTS

#### [NEW SECTION]

**WAC 132J-125-180 ACADEMIC RESPONSIBILITIES** Admission to Green River Community College carries with it the presumption that students will conduct themselves as responsible and honorable members of the college community. Students are expected to maintain high standards of academic honesty and integrity.

**Reviser's note:** The bracketed material preceding the section above was supplied by the code reviser's office.

#### [NEW SECTION]

**WAC 132J-125-190 STUDENT ACADEMIC RIGHTS** (1) A student has the right to fair and equal treatment in all areas of academic concern.

(2) A student has the right to a fair evaluation of his/her academic work.

(3) A student has the right to clearly stated criteria for evaluation by the faculty.

(4) A student has the right to appeal any academic discipline.

**Reviser's note:** The bracketed material preceding the section above was supplied by the code reviser's office.

**[NEW SECTION]**

**WAC 132J-125-200 PLAGIARISM/CHEATING**

(1) Any student who, for the purpose of fulfilling or partially fulfilling any assignment or task required by the faculty as part of the student's program of instruction, shall commit plagiarism or otherwise knowingly tender any work product that the student falsely represents to the faculty as the student's work product, in whole or in part, shall be subject to discipline.

(2) Any student who knowingly aids or abets the accomplishment of cheating, as defined in subsection (1) of this section, shall also be subject to discipline.

**Reviser's note:** The bracketed material preceding the section above was supplied by the code reviser's office.

**[NEW SECTION]**

**WAC 132J-125-210 CLASSROOM CONDUCT**

Any student who significantly disrupts any college class and makes it unreasonably difficult to conduct the class in an orderly manner shall be subject to discipline.

**Reviser's note:** The bracketed material preceding the section above was supplied by the code reviser's office.

**[NEW SECTION]**

**WAC 132J-125-220 INITIATION OF ACADEMIC DISCIPLINE** (1) After considering available information about possible violation of an academic rule:

(a) A college instructor, after meeting or attempting to meet with the accused student, and upon written notice to the student, may assign to the student a lower or failing grade for an individual project, test or paper or for the entire course;

(b) The student's dean, after consulting with the division or department involved and meeting or attempting to meet with the accused student, may recommend modification of the instructor's action and/or dismissal of the student from the college;

(c) The vice president for instruction, after consulting with the dean and meeting or attempting to meet with the accused student, may modify the instructor's action and/or place the student on probation or dismiss the student from the college.

(2) Written notice of any academic discipline under this rule (a) shall be either delivered personally or mailed by first class mail to the student's last known address, within sixty academic days after the later of the student misconduct or the date the misconduct was discovered or should have been discovered, and (b) shall advise the student of his/her right to appeal under these rules.

**Reviser's note:** The bracketed material preceding the section above was supplied by the code reviser's office.

**[NEW SECTION]**

**WAC 132J-125-230 STUDENT ACADEMIC GRIEVANCE** An academic grievance refers to a claim by a student that:

(1) A specific grade assigned to the student by an instructor is the result of an arbitrary or capricious application of otherwise valid standards of academic evaluation;

(2) The standards employed by an instructor in evaluating the student's academic progress are arbitrary or capricious; or

(3) An instructor or academic administrator has made an arbitrary or capricious decision or taken an arbitrary or capricious action which adversely and significantly affects the student's academic standing or career.

**Reviser's note:** The bracketed material preceding the section above was supplied by the code reviser's office.

**[NEW SECTION]**

**WAC 132J-125-240 APPEAL OF ACADEMIC DISCIPLINE; FILING OF ACADEMIC GRIEVANCE** (1) A student may appeal academic discipline or initiate an academic grievance by the following steps:

(a) Step One — Within ten days of the earlier of mailing or personal receipt of notice of the disciplinary action or receipt of notice or information about the facts on which the grievance is based, the student must meet or deliver a written request to meet immediately with his/her instructor to discuss the specific academic discipline or grievance.

(b) Step Two — If no resolution occurs, the student must notify the vice president for marketing and student development. That vice president or his/her designee shall attempt to arrange a meeting with the student, faculty member and division chairperson.

(c) Step Three — If no resolution occurs, the student must again notify the vice president for marketing and student development or designee, who shall attempt to arrange a meeting between the student and the appropriate instructional administrator.

(d) Step Four — If no resolution occurs, the student must again notify the vice president for marketing and student development or designee, who shall attempt to arrange a meeting between the student and the vice president for instruction.

(2) Every affected person shall act promptly and in good faith to complete these four steps in an expeditious manner. Failure to act promptly and in good faith shall be cause for the vice president for marketing and student development or designee to uphold or dismiss the appeal or grievance without completion of any remaining step, provided that any such action shall itself be appealable to the academic board.

(3) If no resolution has occurred through use of all of these four steps within twenty days after the action being challenged in the student's appeal or grievance, the student may file with the vice president for marketing and student development, within thirty days after the action being challenged, a written application for an adjudicative proceeding conducted by the academic board. The vice president or designee has discretion to extend this deadline for good cause.

**Reviser's note:** The bracketed material preceding the section above was supplied by the code reviser's office.

**[NEW SECTION]**

**WAC 132J-125-250 COLLEGE ACADEMIC BOARD** (1) The Green River Community College Academic Board is hereby established. The purpose of the academic board is to provide a student with an opportunity to be heard by an independent body with regard to discipline and/or an academic grievance.

(2) The academic board shall be composed of five members, who should be chosen no later than November 1st of each academic year. The board members shall be selected as follows:

(a) The recognized faculty organization shall appoint two members and an alternate; each such person shall serve a two-year term, one beginning and ending in even-numbered years and the other in odd-numbered years, which term shall automatically be extended until a successor is appointed.

(b) The president of the recognized student organization shall appoint one member and an alternate; each such person shall serve a one-year term, which shall automatically be extended until a successor is appointed.

(c) The college president shall appoint one member and an alternate from the college administration, neither of them being the vice president for marketing and student development, who shall serve at the pleasure of the president.

(d) The chairperson of the board shall be a college dean not previously involved in the case, as designated by the vice president for marketing and student development.

**Reviser's note:** The bracketed material preceding the section above was supplied by the code reviser's office.

#### SECTION IV DISCIPLINE/GRIEVANCE ADJUDICATIONS

##### [NEW SECTION]

**WAC 132J-125-260 DISCIPLINE AND GRIEVANCE—TYPE OF ADJUDICATIVE PROCEEDING**

(1) A student may appeal a disciplinary action or continue an academic grievance by filing a written application for an adjudicative proceeding with the vice president for marketing and student development as specified in WAC 132J-125-165 or 132J-125-240. The application may, but need not, be on a form provided under WAC 132J-108-040.

(2) The vice president for marketing and student development or designee shall determine, after promptly meeting or attempting to meet with the student, (a) whether the disciplinary board or the academic board should hear the appeal and (b) whether the matter will be heard as a regular adjudicative proceeding or a brief adjudicative proceeding.

(3) In an academic grievance case or a case where the student is appealing disciplinary dismissal from the college, the student shall be entitled to a regular adjudicative proceeding under WAC 132J-125-280 if he/she files a proper written application for such a proceeding.

(4) In any other case, the matter shall be handled as a brief adjudicative proceeding under WAC 132J-125-290.

**Reviser's note:** The bracketed material preceding the section above was supplied by the code reviser's office.

##### [NEW SECTION]

**WAC 132J-125-270 DISCIPLINE AND GRIEVANCE—PROCEEDINGS GENERALLY** In both adjudicative proceedings and brief adjudicative proceedings:

(1) The matter shall be heard by the presiding officer de novo.

(2) No person may serve as a presiding officer or board member in a particular case if he/she has direct and significant personal knowledge of the relevant facts. Disqualification and replacement of a board member, for a particular case only, shall be as provided in RCW 34.05.425, with substitution of that member's alternate.

(3) Failure to participate or cooperate in the proceeding may be taken into consideration by the presiding officer and shall not preclude the presiding officer from making a decision. This shall not in any way limit the possibility of a default under RCW 34.05.440.

(4) The vice president for marketing and student development may designate a representative on behalf of the disciplinary action or faculty member. No attorney representative of any party may participate in a hearing unless he/she has filed and served a notice of appearance at least five days before the hearing, but in the event of such notice any other party may also have counsel.

(5) The presiding officer may exclude from a meeting or hearing any person whose conduct is disruptive.

(6) The presiding officer and, subsequently, a reviewing officer may affirm, modify, or reverse any previous decision or action in the matter, and a reviewing officer may remand, in accordance with RCW 34.05.464 or RCW 34.05.491 as applicable.

**Reviser's note:** The bracketed material preceding the section above was supplied by the code reviser's office.

##### [NEW SECTION]

**WAC 132J-125-280 DISCIPLINE AND GRIEVANCE — REGULAR ADJUDICATIVE PROCEEDINGS** In a regular adjudicative proceeding:

(1) RCW 34.05.413 through 34.05.476 and chapters 10-08 and 132J-108 WAC shall govern, unless otherwise provided in these rules. For purposes of RCW 34.05.425 and WAC 132J-108-020, the college board of trustees and college president designate the appropriate hearing board (disciplinary or academic) as presiding officer and designate that board's chairperson to make procedural decisions.

(2) The presiding officer shall designate a non-voting record-keeping clerk and may designate additional non-voting staff as appropriate. Hearings shall be recorded, in accordance with WAC 10-08-170.

(3) The presiding officer may conduct prehearing conference(s) in accordance with RCW 34.05.431 and WAC 10-08-130.

(4) The presiding officer may permit or conduct discovery as provided in RCW 34.05.446, WAC 10-08-120, and WAC 132J-108-060.

(5) The presiding officer(s) shall give not less than seven days advance written notice of a hearing to all parties and intervenors, except where such notice is

waived, in accordance with RCW 34.05.434, WAC 10-08-040 or other applicable law.

(6) Four board members shall constitute a quorum and decisions shall require three or more votes.

(7) Hearings shall be conducted in accordance with chapter 34.05 RCW and chapters 10-08 and 132J-108 WAC.

(8) In a disciplinary proceeding, the burden of proof shall be on the party seeking to uphold the discipline to establish good cause by a preponderance of the evidence. In a grievance proceeding, the burden of proof shall be on the student to establish his/her claim by a preponderance of the evidence.

(9) Within the ninety days specified in RCW 34.05.461, and preferably within thirty days, the presiding officer shall serve on the parties and the president an initial order. At the same time, a full and complete record of the proceedings shall also be transmitted to the president. The initial order shall include a statement of findings and conclusions and otherwise comply with RCW 34.05.461 and WAC 10-08-210. It shall also describe the available administrative review procedures specified in the following subparagraph.

(10) The initial order shall become the final order, without further action, unless within twenty days of service of the initial order (a) the president or president's designee, upon his/her own motion, determines that the initial order should be reviewed or (b) a party to the proceedings files with the president a written petition for administrative review of the initial order. RCW 34.05.464 and WAC 10-08-211 shall apply to any such determination or petition.

**Reviser's note:** The bracketed material preceding the section above was supplied by the code reviser's office.

#### [NEW SECTION]

WAC 132J-125-290 DISCIPLINE AND GRIEVANCE — BRIEF ADJUDICATIVE PROCEEDINGS  
In a brief adjudicative proceeding:

(1) RCW 34.04.485 through 34.05.494 and WAC 10-08-080 shall govern, unless otherwise provided in these rules. For purposes of RCW 34.05.485 and WAC 132J-108-020, the college board of trustees and college president designate the chairperson of the appropriate hearing board (disciplinary or academic) as the sole presiding officer of a brief adjudicative proceeding.

(2) The presiding officer shall serve on the parties and the president an initial order, a brief written statement of the reasons for the decision, within ten days, in accordance with RCW 34.05.485. That statement shall describe the available administrative review procedures specified in the following subparagraph.

(3) Within twenty-one days after service of the initial order, (a) either party may make a written or oral request for administrative review by the president or (b) the president or president's designee may review the matter on his/her own motion. Any such review shall be governed by RCW 34.05.491. If no such review is taken, the initial order shall be the final order.

**Reviser's note:** The bracketed material preceding the section above was supplied by the code reviser's office.

**Reviser's note:** The typographical error in the above section occurred in the copy filed by the agency and appears in the Register pursuant to the requirements of RCW 34.08.040.

#### [NEW SECTION]

WAC 132J-125-300 SUMMARY SUSPENSION OR REMOVAL (1) A student who significantly disrupts any college class, function, or hearing and makes it unreasonably difficult to conduct the class, function, or hearing in an orderly manner shall be subject to summary suspension or removal. This summary action may be in addition to any other disciplinary action for the same misconduct.

(2) A faculty member, vice president other than the vice president for marketing and student development, dean, the coordinator or director of student activities, or designee of any of them, who has observed or otherwise has knowledge about such a disruption, may summarily suspend a student and/or order removal of the student from all or part of the college facilities for a period of up to five academic days. The student ordinarily should, but need not be, warned that such action is possible and given a chance to correct the offensive behavior before summary action is taken.

(3) The student shall be notified, verbally and/or by a writing mailed by first class mail to the student's last known address or hand-delivered, of the summary action taken and the time period during which it is effective. The suspension or removal may begin immediately and may be renewed for an additional five day period.

(4) Upon the student's written request, made within five days of the earlier of mailing or personal receipt of notice of the summary action, the suspension or removal shall be reviewed by the vice president for marketing and student development. After such review, the vice president shall issue a written decision continuing, modifying or rescinding the summary action and/or taking any further disciplinary action that he/she deems appropriate.

(5) A student may appeal a summary suspension or removal like any other disciplinary action, by filing an application for an adjudicative proceeding under WAC 132J-125-260. The presiding officer may consolidate this appeal with any related pending matter.

**Reviser's note:** The bracketed material preceding the section above was supplied by the code reviser's office.

#### [NEW SECTION]

WAC 132J-125-310 RECORD-KEEPING (1) The vice president for marketing and student development shall maintain for at least six years the following records of student grievance and disciplinary actions and proceedings:

(a) only initial and final orders in cases where a student's grievance has been sustained or a disciplinary action against a student has been reversed and the student fully exonerated;

(b) the complete records, including all orders, in all other cases where adjudication has been requested;

(c) a list or other summary of all disciplinary actions reported or known to the vice president and not appealed.

(2) Final disciplinary actions shall be entered on student records, provided that the vice president for marketing and student development shall have discretion to remove some or all of that information from a student's record upon the student's request and showing of good cause.

**Reviser's note:** The bracketed material preceding the section above was supplied by the code reviser's office.

### AMENDMENTS

**AMENDATORY SECTION** (Amending WAC 132J-108-020 filed in 90-22-067 Register 11/5/90 effective 12/6/90):

WAC 132J-108-020 **APPOINTMENT OF PRESIDING OFFICERS.** The ~~((president or president's designee shall designate a))~~ presiding officer for an adjudicative proceeding(;) shall be designated by rule or, in the absence of an applicable rule or effective designation, appointed by the president or president's designee. The presiding officer shall be an administrative law judge, a member in good standing of the Washington State Bar Association, a panel of individuals, the president or his or her designee, or any combination of the above. Where more than one individual is designated to be the presiding officer, one person shall be designated by the president or president's designee to make decisions concerning discovery, closure, means of recording adjudicative proceedings, and similar matters.

**AMENDATORY SECTION** (Amending WAC 132J-108-050 filed in 90-22-067 Register 11/5/90 effective 12/6/90):

WAC 132J-108-050 **BRIEF ADJUDICATIVE PROCEDURES.** This rule is adopted in accordance with RCW 34.05.482 through 34.05.494, the provisions of which are hereby adopted. Brief adjudicative procedures shall be used in all matters related to:

- (1) Residency determinations made pursuant to RCW 28B.15.013, conducted by the admissions office;
- (2) Challenges to contents of education records;
- (3) Student conduct proceedings(;), except as otherwise provided in another rule;
- (4) Parking violations;
- (5) Outstanding debts owed by students or employees;
- (6) Loss of eligibility for participation in institution sponsored athletic events;
- (7) Refund of tuition and special fees under WAC 132J-160-010 through 132J-160-050.

**Reviser's note:** RCW 34.05.395 requires the use of underlining and deletion marks to indicate amendments to existing rules. The rule published above varies from its predecessor in certain respects not indicated by the use of these markings.

### REPEALER

The following chapter of the Washington Administrative Code is repealed:

Chapter 132J-120 WAC [Student Body Rights and Responsibilities]

**Reviser's note:** The brackets and enclosed material in the text of the above repealer occurred in the copy filed by the agency and appear in the Register pursuant to the requirements of RCW 34.08.040.

**WSR 92-14-118**  
**PROPOSED RULES**  
**GREEN RIVER**  
**COMMUNITY COLLEGE**  
[Filed July 1, 1992, 10:42 a.m.]

Original Notice.

Title of Rule: Green River Community College, student code of conduct.

Purpose: Green River Community College, an agency of the state of Washington, provides a variety of educational opportunities for students; namely the opportunities to examine the academic, vocational, technical, cultural, social and recreational aspects of society. Green River Community College as an institution of society must maintain conditions conducive to the effective performance of its functions. Consequently, Green River Community College has special expectations regarding the conduct of students. Student conduct that detracts from, or interferes with, the accomplishment of college purposes is not acceptable. The rules regarding the conducts of students are adopted in order to provide students a full understanding of the rules that will enable the college to maintain conditions conducive to the effective performance of the college's functions. Sanctions for the violations of the rules of student conduct will be administered by the college in the manner provided by said rules. When violations of laws of the state of Washington and/or the United States are also involved, the college may refer such matters to the appropriate authorities. In cases of minors, this conduct may also be referred to parents or legal guardians.

Statutory Authority for Adoption: RCW 28B.50.140(13).

Statute Being Implemented: RCW 28B.50.140(13).

Summary: The Administrative Procedure Act, chapter 34.05 RCW, sets forth procedures for agencies to conduct adjudicative proceedings. This contemplates one standardized set of procedures for all agencies within the state and negates the need for each agency to adopt its own detailed procedures.

Reasons Supporting Proposal: This allow the code to be condensed from 49 pages to 27 pages. In addition to the statute, there is one set of rules for the whole state (chapter 10-08 WAC), adopted by the Office of Administrative Hearings.

Name of Agency Personnel Responsible for Drafting and Implementation: Michael McIntyre, Green River Community College, 12401 S.E. 320th Street, Auburn, WA 98002, (206) 833-9111 x251; and Enforcement: Rich Rutkowski and Mike McIntyre, Green River Community College, 12401 S.E. 320th Street, Auburn, WA 98002, (206) 833-9111 x251.

Name of Proponent: Green River Community College, public.

Rule is not necessitated by federal law, federal or state court decision.

Explanation of Rule, its Purpose, and Anticipated Effects: The code for the Green River Community College has special expectations regarding the conduct of students. Student conduct that detracts from, or interferes with, the accomplishment of college purposes is not acceptable. The rules clearly provide students a full understanding that will enable the college to maintain conditions to the effective performance for the college's functions.

Proposal does not change existing rules.

No small business economic impact statement is required for this proposal by chapter 19.85 RCW.

Hearing Location: Green River Community College, Administration Building, Board Room, 12401 S.E. 320th Street, Auburn, WA 98002, on September 17, 1992, at 12-1 p.m.

Submit Written Comments to: Michael McIntyre, Green River Community College, 12401 S.E. 320th Street, Auburn, WA 98002, by September 11, 1992.

Date of Intended Adoption: September 17, 1992.

June 24, 1992

Michael McIntyre  
Vice-President for Marketing  
and Student Development

#### GREEN RIVER COMMUNITY COLLEGE

#### RULES OF STUDENT CONDUCT

##### SECTION I INTRODUCTION

WAC 132J-125-010	PURPOSE
WAC 132J-125-020	DEFINITIONS
WAC 132J-125-030	JURISDICTION

##### SECTION II NONACADEMIC RIGHTS AND RESPONSIBILITIES

WAC 132J-125-055	RIGHT TO DEMAND IDENTIFICATION
WAC 132J-125-060	FREEDOM OF EXPRESSION
WAC 132J-125-065	RIGHT TO ASSEMBLY
WAC 132J-125-070	RIGHT TO OUTSIDE SPEAKERS
WAC 132J-125-075	RIGHT TO SALE OF PERSONAL PROPERTY
WAC 132J-125-080	DISTRIBUTION OF MATERIALS
WAC 132J-125-085	DENIAL OF ACCESS TO GREEN RIVER
COMM. COLLEGE	
WAC 132J-125-090	TRESPASS
WAC 132J-125-095	SMOKING
WAC 132J-125-100	LIQUOR
WAC 132J-125-105	DRUGS/SUBSTANCE ABUSE
WAC 132J-125-110	CONDUCT AT COLLEGE FUNCTIONS
WAC 132J-125-115	THEFT; STOLEN PROPERTY; ROBBERY
WAC 132J-125-120	DAMAGING PROPERTY
WAC 132J-125-125	INTERFERENCE; INTIMIDATION
WAC 132J-125-130	OFFENSIVE LANGUAGE
WAC 132J-125-135	SEXUAL HARASSMENT
WAC 132J-125-140	FORGERY OR ALTERATION OF RECORDS
WAC 132J-125-145	COMPUTER TRESPASS
WAC 132J-125-150	FIREARMS/EXPLOSIVES
WAC 132J-125-155	OTHER PUNISHABLE ACTS
WAC 132J-125-160	INITIATION AND TYPES OF NONACADEMIC
DISCIPLINE	
WAC 132J-125-165	APPEAL OF NONACADEMIC DISCIPLINE
WAC 132J-125-170	COLLEGE DISCIPLINARY BOARD

##### SECTION III ACADEMIC RESPONSIBILITIES AND RIGHTS

WAC 132J-125-180	ACADEMIC RESPONSIBILITIES
WAC 132J-125-190	STUDENT ACADEMIC RIGHTS
WAC 132J-125-200	PLAGIARISM/CHEATING
WAC 132J-125-210	CLASSROOM CONDUCT
WAC 132J-125-220	INITIATION OF ACADEMIC DISCIPLINE
WAC 132J-125-230	STUDENT ACADEMIC GRIEVANCE
WAC 132J-125-240	APPEAL OF ACADEMIC DISCIPLINE; FILING
OF ACADEMIC GRIEVANCE	
WAC 132J-125-250	COLLEGE ACADEMIC BOARD

##### SECTION IV DISCIPLINE/GRIEVANCE ADJUDICATIONS

WAC 132J-125-260	DISCIPLINE AND GRIEVANCE—TYPE OF ADJUDICATIVE PROCEEDING
WAC 132J-125-270	DISCIPLINE AND GRIEVANCE—PROCEEDINGS GENERALLY
WAC 132J-125-280	DISCIPLINE AND GRIEVANCE—REGULAR ADJUDICATIVE PROCEEDINGS
WAC 132J-125-290	DISCIPLINE AND GRIEVANCE—BRIEF ADJUDICATIVE PROCEEDINGS
WAC 132J-125-300	SUMMARY SUSPENSION OR REMOVAL
WAC 132J-125-310	RECORD-KEEPING

##### AMENDMENTS

WAC 132J-108-020	APPOINTMENT OF PRESIDING OFFICERS
WAC 132J-108-050	BRIEF ADJUDICATIVE PROCEDURES

##### REPEALER

WAC 132J-120	STUDENT BODY RIGHTS AND RESPONSIBILITIES
--------------	--

#### RULES OF STUDENT CONDUCT

##### SECTION I INTRODUCTION

##### [NEW SECTION]

WAC 132J-125-010 PURPOSE (1) Green River Community College, an agency of the state of Washington, provides a variety of educational opportunities for students; namely the opportunities to examine the academic, vocational, technical, cultural, social and recreational aspects of society. Green River Community College as an institution of society must maintain conditions conducive to the effective performance of its functions. Consequently, Green River Community College has special expectations regarding the conduct of students. Student conduct that detracts from, or interferes with, the accomplishment of college purposes is not acceptable.

(2) The student is, first of all, a member of the community at large, and as such has the rights and responsibilities of any citizen. In addition, admission to Green River Community College carries with it the presumption that students will conduct themselves as responsible members of the college community. This includes an expectation that students will obey the law, will comply with rules and regulations of the college, will maintain a high standard of integrity and honesty, and will respect the rights, privileges and property of other members of the college community.

(3) The following rules regarding the conduct of students are adopted in order to provide students a full understanding of the rules that will enable the college to maintain conditions conducive to the effective performance of the college's functions. Sanctions for violations of the rules of student conduct will be administered by the college in the manner provided by said rules. When violations of laws of the state of Washington and/or the United States are also involved, the college may refer such matters to the appropriate authorities. In cases of minors, this conduct may also be referred to parents or legal guardians.

**Reviser's note:** The bracketed material preceding the section above was supplied by the code reviser's office.

##### [NEW SECTION]

WAC 132J-125-020 DEFINITIONS As used in this chapter, unless the context requires otherwise:

(1) "Administration" and "administrator" include the president, assistant(s) to the president, vice presidents, deans, directors of programs or functions, and everyone else designated as a member of the administration by the board of trustees.

(2) "Arbitrary or capricious" refers to willful or unreasonable action, taken without consideration of, or in disregard of, facts or circumstances of a particular case. Where there is room for two reasonable opinions, an action shall not be deemed to be arbitrary or capricious when taken honestly and upon due consideration, however much it may be believed that an erroneous conclusion has been reached.

(3) "Assembly" means any overt activity engaged in by two or more persons, the object of which is to gain publicity, advocate a view, petition for a cause, or disseminate information to any person, persons, or group of persons.

(4) "College" means the institution(s) operated by the board of trustees of the district.



(5) "College community" is composed of all individuals who are enrolled in classes and/or employed by the college.

(6) "College facilities" and "college facility" mean and include any and all real and personal property owned, rented, leased or operated by the board of trustees of Washington State Community College District 10, and shall include all buildings and appurtenances attached thereto and all parking lots and other grounds.

(7) "Designee" means a person appointed in writing by an officer or other person designated in a rule to perform a function, to perform that function on the appointer's behalf.

(8) "Disciplinary action" and "discipline" shall mean and include reprimand, probation, suspension, dismissal, monetary fine, restitution, and any other action taken against a student as a sanction or penalty for violation of a designated rule of student conduct.

(9) "District" means Washington State Community College District 10.

(10) "Faculty member" and "instructor" mean any employee of Washington Community College District 10 who is employed on a full or part-time basis as a teacher, instructor, counselor or librarian.

(11) "President" is the chief executive officer of the college appointed by the board of trustees.

(12) "Recognized student organization" means the organization established by and operated pursuant to the Constitution of the Associated Students of Green River Community College.

(13) "Rules of student conduct" shall mean those rules regulating student conduct as herein adopted.

(14) "Service," "serve," "filing" and "file" shall have the meanings in WAC 10-08-110.

(15) "Student" is any person who is enrolled for classes or is formally in the process of applying for admission to the college.

(16) The singular includes the plural and vice versa, the masculine includes the feminine and vice versa, and the disjunctive includes the conjunctive and vice versa.

**Reviser's note:** The bracketed material preceding the section above was supplied by the code reviser's office.

#### [NEW SECTION]

WAC 132J-125-030 JURISDICTION This chapter shall apply to students and student conduct which occurs (1) on or in a college facility or (2) whenever a student is present at or engaged in any college-sponsored program or function. This chapter is not exclusive, and where conduct becomes known which may also violate any other rule or provision of law, nothing herein shall limit the right or duty of any person to report elsewhere or seek another remedy for that conduct.

**Reviser's note:** The bracketed material preceding the section above was supplied by the code reviser's office.

#### SECTION II

#### NONACADEMIC RIGHTS AND RESPONSIBILITIES

#### [NEW SECTION]

WAC 132J-125-055 RIGHT TO DEMAND IDENTIFICATION (1) For the purpose of determining identity of a person as a student, any faculty member, college administrator, or designee of the president may demand that any person produce evidence of student enrollment at the college. Presenting a current student identification card with a picture I.D. card will be deemed proof of student status.

(2) Refusal by a student to produce identification as required shall be cause for disciplinary action.

**Reviser's note:** The bracketed material preceding the section above was supplied by the code reviser's office.

#### [NEW SECTION]

WAC 132J-125-060 FREEDOM OF EXPRESSION The right of free speech is fundamental to the democratic process. Students and other members of the college community shall be free to express their views or support causes by orderly means which do not disrupt the regular and essential operations of the college.

**Reviser's note:** The bracketed material preceding the section above was supplied by the code reviser's office.

#### [NEW SECTION]

WAC 132J-125-065 RIGHT TO ASSEMBLY (1) Students shall have the right of "assembly" upon college facilities that are generally available to the public. Such assembly shall:

- (a) Be conducted in an orderly manner;
- (b) Not unreasonably interfere with vehicular or pedestrian traffic;
- (c) Not unreasonably interfere with classes, schedules, meetings or ceremonies, and

(d) Not unreasonably interfere with the regular activities of the college.

(2) A student who conducts or participates in an assembly in a manner which causes or helps to cause a violation of this section shall be subject to discipline.

(3) All speakers at an assembly shall allow time, insofar as circumstances reasonably permit, for a question and answer session.

(4) Sound amplifying equipment shall not be used without permission of the college president or president's designee.

**Reviser's note:** The bracketed material preceding the section above was supplied by the code reviser's office.

#### [NEW SECTION]

WAC 132J-125-070 RIGHT TO OUTSIDE SPEAKERS (1) Any recognized student organization, after written notification to the dean for student programs as prescribed herein, may invite a speaker to the college, subject to any restraints imposed by law.

(2) The appearance of an invited speaker at the college does not represent an endorsement, either implicit or explicit, by the college.

(3) The scheduling of facilities for hearing invited speakers shall be made through the college conference and scheduling office.

(4) The dean for student programs must be notified in writing at least four academic days prior to the appearance of an invited speaker. Notification shall include time, location and sponsoring organization. An exception to the four day notification requirement may be made by the dean for student programs or the vice president for marketing and student development.

(5) All speakers shall allow time, insofar as circumstances reasonably permit, for a question and answer session.

**Reviser's note:** The bracketed material preceding the section above was supplied by the code reviser's office.

#### [NEW SECTION]

WAC 132J-125-075 RIGHT TO SALE OF PERSONAL PROPERTY (1) Students have the right to engage in legal, incidental sales of personal property in private transactions.

(2) All other sales shall take place in Lindbloom Student Center subject to the approval and requirements of the dean for student programs or designee.

**Reviser's note:** The bracketed material preceding the section above was supplied by the code reviser's office.

#### [NEW SECTION]

WAC 132J-125-080 DISTRIBUTION OF MATERIALS (1) Handbills, leaflets, newspapers and similar materials may be distributed free of charge upon college facilities designated by the dean for student programs, provided that such distribution does not interfere with the ingress and egress of persons or interfere with the free flow of vehicle or pedestrian traffic.

(2) All students and nonstudents shall register with the dean for student programs prior to distributing any handbill, leaflet, newspaper or related matter, including, but not limited to, materials to be posted on college bulletin boards.

(3) The distribution of materials is prohibited in parking areas.

(4) All handbills, leaflets, newspapers and similar materials should identify the publisher and the distributing organization or individual.

(5) Distribution by means of accosting individuals or unreasonably disruptive behavior is prohibited.

(6) Any student who violates any provision of this rule relating to the distribution and sale of handbills, leaflets, newspapers or similar materials shall be subject to discipline.

(7) Any distribution of the materials regulated in this section shall not be construed as approval of the same by the college.

**Reviser's note:** The bracketed material preceding the section above was supplied by the code reviser's office.



**[NEW SECTION]**

**WAC 132J-125-085 DENIAL OF ACCESS TO GREEN RIVER COMMUNITY COLLEGE** (1) The vice president for marketing and student development may deny admission to a prospective student, or continued attendance to an enrolled student, if it reasonably appears that the student would not be competent to profit from the curriculum offerings of the college, or would, by the student's presence or conduct, create a disruptive atmosphere within the college or a substantial risk of actual harm to a member of the campus community.

(2) Denial of access decisions may be appealed, as or like disciplinary actions, to the disciplinary board or academic board, whichever is designated by the vice president for marketing and student development.

**Reviser's note:** The bracketed material preceding the section above was supplied by the code reviser's office.

**[NEW SECTION]**

**WAC 132J-125-090 TRESPASS** (1) In the instance of any event that the vice president for marketing and student development or designee deems to be disruptive of order, or deems to impede the movement of persons or vehicles, or deems to disrupt or threaten to disrupt the ingress or egress of persons from college facilities, the vice president for marketing and student development or designee is authorized to:

(a) Prohibit the entry of any person, or withdraw from any person the license or permission to enter onto or remain, upon any portion of a college facility;

(b) Give notice against trespass to any person from whom the license or permission has been withdrawn or who has been prohibited from entering onto or remaining upon all or any portion of a college facility;

(c) Order any person to leave or vacate all or any portion of a college facility.

(2) Any student who disobeys a lawful order given by the vice president or designee pursuant to subsection (1) shall be subject to discipline.

**Reviser's note:** The bracketed material preceding the section above was supplied by the code reviser's office.

**[NEW SECTION]**

**WAC 132J-125-095 SMOKING** Smoking in college buildings and in areas of the campus not specifically posted by the administration as open for smoking is not permitted. Violations of this section shall be cause for discipline.

**Reviser's note:** The bracketed material preceding the section above was supplied by the code reviser's office.

**[NEW SECTION]**

**WAC 132J-125-100 LIQUOR** Any student who, while in any college facility or participating in a college-related program, uses, possesses, consumes, is demonstrably under the influence of, or sells any liquor as defined in RCW 66.04.010, in violation of law or in a manner which significantly disrupts a college activity, shall be subject to discipline.

**Reviser's note:** The bracketed material preceding the section above was supplied by the code reviser's office.

**[NEW SECTION]**

**WAC 132J-125-105 DRUGS/SUBSTANCE ABUSE** Any student who, while in any college facility or participating in a college-related program, uses, possesses, consumes, is demonstrably under the influence of, or sells any narcotic drug or controlled substance as defined in RCW 69.50.101, in violation of law or in a manner which significantly disrupts a college activity, shall be subject to discipline. For purposes of this section, "sell" includes the statutory meaning in RCW 69.50.410.

**Reviser's note:** The bracketed material preceding the section above was supplied by the code reviser's office.

**[NEW SECTION]****WAC 132J-125-110 CONDUCT AT COLLEGE FUNCTIONS**

Any student who significantly disrupts any college function by intentionally engaging in conduct that renders it difficult or impossible to continue such a function in an orderly manner, shall be subject to discipline. A college function for this purpose includes, but is not limited to, any disciplinary, grievance, or appeal meeting or hearing under these rules.

**Reviser's note:** The bracketed material preceding the section above was supplied by the code reviser's office.

**[NEW SECTION]**

**WAC 132J-125-115 THEFT; STOLEN PROPERTY; ROBBERY** Any student who, while in any college facility or participating in a college-related program, commits theft as defined in RCW 9A.56.020, or possesses stolen property as defined in RCW 9A.56.140, or commits robbery as defined in RCW 9A.56.190, shall be subject to discipline.

**Reviser's note:** The bracketed material preceding the section above was supplied by the code reviser's office.

**[NEW SECTION]**

**WAC 132J-125-120 DAMAGING PROPERTY** (1) Any student who causes or attempts to cause physical damage to property owned, controlled or operated by the district, or to property owned, controlled or operated by another person while said property is located on college facilities, shall be subject to discipline.

(2) Any student who in this or any other manner is guilty of malicious mischief in violation of RCW 9A.48.070 through 9A.48.100 shall be subject to discipline.

**Reviser's note:** The bracketed material preceding the section above was supplied by the code reviser's office.

**[NEW SECTION]**

**WAC 132J-125-125 INTERFERENCE; INTIMIDATION** Any student who, while in any college facility or participating in a college-related program, shall interfere by force or violence with, or intimidate by threat of force or violence, another person who is in the peaceful discharge or conduct of his/her duties or studies, in the manner prohibited by RCW 28B.10.570 or 28B.10.571, shall be subject to discipline.

**Reviser's note:** The bracketed material preceding the section above was supplied by the code reviser's office.

**[NEW SECTION]**

**WAC 132J-125-130 OFFENSIVE LANGUAGE** Any student who, while in any college facility or participating in a college-related program, and without a privilege to do so, uses language which he/she knows or should know is offensive to a reasonable person, shall be subject to discipline.

**Reviser's note:** The bracketed material preceding the section above was supplied by the code reviser's office.

**[NEW SECTION]**

**WAC 132J-125-135 SEXUAL HARASSMENT** Any student who, while in any college facility or participating in a college-related program, knowingly engages in unwelcome sexual advances, requests for sexual favors, and other verbal or physical conduct of a sexual nature, where such behavior offends the recipient, causes discomfort or humiliation, or interferes with job or academic performance, shall be subject to discipline.

**Reviser's note:** The bracketed material preceding the section above was supplied by the code reviser's office.

**[NEW SECTION]**

**WAC 132J-125-140 FORGERY OR ALTERATION OF RECORDS** Any student who, while in any college facility or participating in a college-related program, engages in forgery, as defined in RCW 9A.60.020, shall be subject to discipline.

**Reviser's note:** The bracketed material preceding the section above was supplied by the code reviser's office.

**[NEW SECTION]**

**WAC 132J-125-145 COMPUTER TRESPASS** Any student who, without authorization, intentionally gains access to a computer system or electronic data of another student, a faculty member or the district, in violation of RCW 9A.52.110 through 9A.52.130, shall be subject to discipline.

**Reviser's note:** The bracketed material preceding the section above was supplied by the code reviser's office.

**[NEW SECTION]**

**WAC 132J-125-150 FIREARMS/EXPLOSIVES** Any student who, while in any college facility or participating in a college-related program, uses or has on his/her person firearms or explosive materials, without written permission of the vice president for marketing and student development or vice president's designee, shall be subject to discipline.

**Reviser's note:** The bracketed material preceding the section above was supplied by the code reviser's office.

**[NEW SECTION]**

**WAC 132J-125-155 OTHER PUNISHABLE ACTS** Any student who, while in any college facility or participating in a college-related program, commits any other act which is a crime under the laws of the state of Washington or the United States and which act does not otherwise violate a rule of student conduct, shall be subject to discipline.

**Reviser's note:** The bracketed material preceding the section above was supplied by the code reviser's office.

**[NEW SECTION]**

**WAC 132J-125-160 INITIATION AND TYPES OF NONACADEMIC DISCIPLINE** (1) Any college administrator, except the president or a member of the disciplinary board, may take either of the following disciplinary actions against a student, for causes other than cheating or classroom misconduct:

(a) Warning: An oral or written notice to a student that college expectations about conduct have not been met;

(b) Reprimand: A written notice, designated as a reprimand, which censures a student for improper conduct and includes a warning that continuation or repetition of improper conduct may result in other, further discipline.

(2) A copy of any written warning or reprimand should be provided to the vice president for marketing and student development.

(3) The vice president for marketing and student development, or designee, after meeting or attempting to meet with the student to advise of the potential violation and penalties, may issue a warning or reprimand or take any of the following disciplinary actions against a student, for causes other than cheating or classroom misconduct:

(a) Probation: A written statement placing specific conditions upon the student's continued attendance at the college, for a stated period of time not exceeding termination of the student's enrollment. Violation of any such condition shall be cause for further disciplinary action;

(b) Suspension or Dismissal: Written termination of status as a student at the college, for a period of time that is limited (suspension) or indefinite or open-ended (dismissal). The written notice should indicate any condition(s) for readmission, and that written application for readmission must be made to the vice president for marketing and student development. Upon receipt of such an application, with justification deemed adequate by that vice president, the student may be readmitted. No fees will be refunded for the quarter in which the action is taken;

(c) Monetary fine or restitution: A written order, alone or combined with another disciplinary action, requiring the student to pay, within a stated time limit, appropriate restitution for a financial loss caused by the student's misconduct and/or a monetary fine not exceeding one quarter's tuition. Failure to pay shall be cause for further disciplinary action and/or cancelling and barring the student's registration.

(4) Any written notice of disciplinary action under this rule (a) shall be either delivered personally or mailed by first class mail to the student's last known address, within sixty academic days after the later of

the student misconduct or the date the misconduct was discovered or should have been discovered, and (b) shall advise the student of his/her right to appeal under these rules.

**Reviser's note:** The bracketed material preceding the section above was supplied by the code reviser's office.

**[NEW SECTION]**

**WAC 132J-125-165 APPEAL OF NONACADEMIC DISCIPLINE** A student may appeal a nonacademic disciplinary action by filing with the vice president for marketing and student development, within twenty days after the earlier of personal delivery or mailing of notice of the disciplinary action, a written application for an adjudicative proceeding conducted by the disciplinary board. The vice president or designee has discretion to extend this deadline for good cause.

**Reviser's note:** The bracketed material preceding the section above was supplied by the code reviser's office.

**[NEW SECTION]**

**WAC 132J-125-170 COLLEGE DISCIPLINARY BOARD** (1) The Green River Community College Disciplinary Board is hereby established. The purpose of the disciplinary board is to provide a student with an opportunity to be heard by an independent body with regard to nonacademic discipline.

(2) The disciplinary board shall be composed of five members, who should be chosen no later than November first of each academic year. The board members shall be selected as follows:

(a) The recognized faculty organization shall appoint one member and an alternate; each such person shall serve a two-year term, which shall automatically be extended until his/her successor is appointed.

(b) The president of the recognized student organization shall appoint two members and an alternate; each such person shall serve a one-year term, which shall automatically be extended until a successor is appointed.

(c) The college president shall appoint one member and an alternate from the college administration, neither of them being the vice president for marketing and student development, who shall serve at the pleasure of the president.

(d) The chairperson of the board shall be the person functioning as dean of educational planning or his/her designee; if that dean is disqualified from serving, the chairperson shall be the person functioning as dean of student programs or his/her designee.

**Reviser's note:** The bracketed material preceding the section above was supplied by the code reviser's office.

**SECTION III  
ACADEMIC RESPONSIBILITIES AND RIGHTS**

**[NEW SECTION]**

**WAC 132J-125-180 ACADEMIC RESPONSIBILITIES** Admission to Green River Community College carries with it the presumption that students will conduct themselves as responsible and honorable members of the college community. Students are expected to maintain high standards of academic honesty and integrity.

**Reviser's note:** The bracketed material preceding the section above was supplied by the code reviser's office.

**[NEW SECTION]**

**WAC 132J-125-190 STUDENT ACADEMIC RIGHTS** (1) A student has the right to fair and equal treatment in all areas of academic concern.

(2) A student has the right to a fair evaluation of his/her academic work.

(3) A student has the right to clearly stated criteria for evaluation by the faculty.

(4) A student has the right to appeal any academic discipline.

**Reviser's note:** The bracketed material preceding the section above was supplied by the code reviser's office.

**[NEW SECTION]**

**WAC 132J-125-200 PLAGIARISM/CHEATING** (1) Any student who, for the purpose of fulfilling or partially fulfilling any assignment or task required by the faculty as part of the student's program

of instruction, shall commit plagiarism or otherwise knowingly tender any work product that the student falsely represents to the faculty as the student's work product, in whole or in part, shall be subject to discipline.

(2) Any student who knowingly aids or abets the accomplishment of cheating, as defined in subsection (1) of this section, shall also be subject to discipline.

**Reviser's note:** The bracketed material preceding the section above was supplied by the code reviser's office.

**[NEW SECTION]**

**WAC 132J-125-210 CLASSROOM CONDUCT** Any student who significantly disrupts any college class and makes it unreasonably difficult to conduct the class in an orderly manner shall be subject to discipline.

**Reviser's note:** The bracketed material preceding the section above was supplied by the code reviser's office.

**[NEW SECTION]**

**WAC 132J-125-220 INITIATION OF ACADEMIC DISCIPLINE** (1) After considering available information about possible violation of an academic rule:

(a) A college instructor, after meeting or attempting to meet with the accused student, and upon written notice to the student, may assign to the student a lower or failing grade for an individual project, test or paper or for the entire course;

(b) The student's dean, after consulting with the division or department involved and meeting or attempting to meet with the accused student, may recommend modification of the instructor's action and/or dismissal of the student from the college;

(c) The vice president for instruction, after consulting with the dean and meeting or attempting to meet with the accused student, may modify the instructor's action and/or place the student on probation or dismiss the student from the college.

(2) Written notice of any academic discipline under this rule (a) shall be either delivered personally or mailed by first class mail to the student's last known address, within sixty academic days after the later of the student misconduct or the date the misconduct was discovered or should have been discovered, and (b) shall advise the student of his/her right to appeal under these rules.

**Reviser's note:** The bracketed material preceding the section above was supplied by the code reviser's office.

**[NEW SECTION]**

**WAC 132J-125-230 STUDENT ACADEMIC GRIEVANCE** An academic grievance refers to a claim by a student that:

(1) A specific grade assigned to the student by an instructor is the result of an arbitrary or capricious application of otherwise valid standards of academic evaluation;

(2) The standards employed by an instructor in evaluating the student's academic progress are arbitrary or capricious; or

(3) An instructor or academic administrator has made an arbitrary or capricious decision or taken an arbitrary or capricious action which adversely and significantly affects the student's academic standing or career.

**Reviser's note:** The bracketed material preceding the section above was supplied by the code reviser's office.

**[NEW SECTION]**

**WAC 132J-125-240 APPEAL OF ACADEMIC DISCIPLINE; FILING OF ACADEMIC GRIEVANCE** (1) A student may appeal academic discipline or initiate an academic grievance by the following steps:

(a) Step One — Within ten days of the earlier of mailing or personal receipt of notice of the disciplinary action or receipt of notice or information about the facts on which the grievance is based, the student must meet or deliver a written request to meet immediately with his/her instructor to discuss the specific academic discipline or grievance.

(b) Step Two — If no resolution occurs, the student must notify the vice president for marketing and student development. That vice president or his/her designee shall attempt to arrange a meeting with the student, faculty member and division chairperson.

(c) Step Three — If no resolution occurs, the student must again notify the vice president for marketing and student development or designee, who shall attempt to arrange a meeting between the student and the appropriate instructional administrator.

(d) Step Four — If no resolution occurs, the student must again notify the vice president for marketing and student development or designee, who shall attempt to arrange a meeting between the student and the vice president for instruction.

(2) Every affected person shall act promptly and in good faith to complete these four steps in an expeditious manner. Failure to act promptly and in good faith shall be cause for the vice president for marketing and student development or designee to uphold or dismiss the appeal or grievance without completion of any remaining step, provided that any such action shall itself be appealable to the academic board.

(3) If no resolution has occurred through use of all of these four steps within twenty days after the action being challenged in the student's appeal or grievance, the student may file with the vice president for marketing and student development, within thirty days after the action being challenged, a written application for an adjudicative proceeding conducted by the academic board. The vice president or designee has discretion to extend this deadline for good cause.

**Reviser's note:** The bracketed material preceding the section above was supplied by the code reviser's office.

**[NEW SECTION]**

**WAC 132J-125-250 COLLEGE ACADEMIC BOARD** (1) The Green River Community College Academic Board is hereby established. The purpose of the academic board is to provide a student with an opportunity to be heard by an independent body with regard to discipline and/or an academic grievance.

(2) The academic board shall be composed of five members, who should be chosen no later than November 1st of each academic year. The board members shall be selected as follows:

(a) The recognized faculty organization shall appoint two members and an alternate; each such person shall serve a two-year term, one beginning and ending in even-numbered years and the other in odd-numbered years, which term shall automatically be extended until a successor is appointed.

(b) The president of the recognized student organization shall appoint one member and an alternate; each such person shall serve a one-year term, which shall automatically be extended until a successor is appointed.

(c) The college president shall appoint one member and an alternate from the college administration, neither of them being the vice president for marketing and student development, who shall serve at the pleasure of the president.

(d) The chairperson of the board shall be a college dean not previously involved in the case, as designated by the vice president for marketing and student development.

**Reviser's note:** The bracketed material preceding the section above was supplied by the code reviser's office.

**SECTION IV  
DISCIPLINE/GRIEVANCE ADJUDICATIONS**

**[NEW SECTION]**

**WAC 132J-125-260 DISCIPLINE AND GRIEVANCE—TYPE OF ADJUDICATIVE PROCEEDING** (1) A student may appeal a disciplinary action or continue an academic grievance by filing a written application for an adjudicative proceeding with the vice president for marketing and student development as specified in WAC 132J-125-165 or 132J-125-240. The application may, but need not, be on a form provided under WAC 132J-108-040.

(2) The vice president for marketing and student development or designee shall determine, after promptly meeting or attempting to meet with the student, (a) whether the disciplinary board or the academic board should hear the appeal and (b) whether the matter will be heard as a regular adjudicative proceeding or a brief adjudicative proceeding.

(3) In an academic grievance case or a case where the student is appealing disciplinary dismissal from the college, the student shall be entitled to a regular adjudicative proceeding under WAC 132J-125-280 if he/she files a proper written application for such a proceeding.

(4) In any other case, the matter shall be handled as a brief adjudicative proceeding under WAC 132J-125-290.

**Reviser's note:** The bracketed material preceding the section above was supplied by the code reviser's office.

**[NEW SECTION]**

**WAC 132J-125-270 DISCIPLINE AND GRIEVANCE—PROCEEDINGS GENERALLY** In both adjudicative proceedings and brief adjudicative proceedings:

(1) The matter shall be heard by the presiding officer de novo.

(2) No person may serve as a presiding officer or board member in a particular case if he/she has direct and significant personal knowledge of the relevant facts. Disqualification and replacement of a board member, for a particular case only, shall be as provided in RCW 34.05.425, with substitution of that member's alternate.

(3) Failure to participate or cooperate in the proceeding may be taken into consideration by the presiding officer and shall not preclude the presiding officer from making a decision. This shall not in any way limit the possibility of a default under RCW 34.05.440.

(4) The vice president for marketing and student development may designate a representative on behalf of the disciplinary action or faculty member. No attorney representative of any party may participate in a hearing unless he/she has filed and served a notice of appearance at least five days before the hearing, but in the event of such notice any other party may also have counsel.

(5) The presiding officer may exclude from a meeting or hearing any person whose conduct is disruptive.

(6) The presiding officer and, subsequently, a reviewing officer may affirm, modify, or reverse any previous decision or action in the matter, and a reviewing officer may remand, in accordance with RCW 34.05.464 or RCW 34.05.491 as applicable.

**Reviser's note:** The bracketed material preceding the section above was supplied by the code reviser's office.

**[NEW SECTION]**

**WAC 132J-125-280 DISCIPLINE AND GRIEVANCE — REGULAR ADJUDICATIVE PROCEEDINGS** In a regular adjudicative proceeding:

(1) RCW 34.05.413 through 34.05.476 and chapters 10-08 and 132J-108 WAC shall govern, unless otherwise provided in these rules. For purposes of RCW 34.05.425 and WAC 132J-108-020, the college board of trustees and college president designate the appropriate hearing board (disciplinary or academic) as presiding officer and designate that board's chairperson to make procedural decisions.

(2) The presiding officer shall designate a non-voting record-keeping clerk and may designate additional non-voting staff as appropriate. Hearings shall be recorded, in accordance with WAC 10-08-170.

(3) The presiding officer may conduct prehearing conference(s) in accordance with RCW 34.05.431 and WAC 10-08-130.

(4) The presiding officer may permit or conduct discovery as provided in RCW 34.05.446, WAC 10-08-120, and WAC 132J-108-060.

(5) The presiding officer(s) shall give not less than seven days advance written notice of a hearing to all parties and intervenors, except where such notice is waived, in accordance with RCW 34.05.434, WAC 10-08-040 or other applicable law.

(6) Four board members shall constitute a quorum and decisions shall require three or more votes.

(7) Hearings shall be conducted in accordance with chapter 34.05 RCW and chapters 10-08 and 132J-108 WAC.

(8) In a disciplinary proceeding, the burden of proof shall be on the party seeking to uphold the discipline to establish good cause by a preponderance of the evidence. In a grievance proceeding, the burden of proof shall be on the student to establish his/her claim by a preponderance of the evidence.

(9) Within the ninety days specified in RCW 34.05.461, and preferably within thirty days, the presiding officer shall serve on the parties and the president an initial order. At the same time, a full and complete record of the proceedings shall also be transmitted to the president. The initial order shall include a statement of findings and conclusions and otherwise comply with RCW 34.05.461 and WAC 10-08-

210. It shall also describe the available administrative review procedures specified in the following subparagraph.

(10) The initial order shall become the final order, without further action, unless within twenty days of service of the initial order (a) the president or president's designee, upon his/her own motion, determines that the initial order should be reviewed or (b) a party to the proceedings files with the president a written petition for administrative review of the initial order. RCW 34.05.464 and WAC 10-08-211 shall apply to any such determination or petition.

**Reviser's note:** The bracketed material preceding the section above was supplied by the code reviser's office.

**[NEW SECTION]**

**WAC 132J-125-290 DISCIPLINE AND GRIEVANCE — BRIEF ADJUDICATIVE PROCEEDINGS** In a brief adjudicative proceeding:

(1) RCW 34.04.485 through 34.05.494 and WAC 10-08-080 shall govern, unless otherwise provided in these rules. For purposes of RCW 34.05.485 and WAC 132J-108-020, the college board of trustees and college president designate the chairperson of the appropriate hearing board (disciplinary or academic) as the sole presiding officer of a brief adjudicative proceeding.

(2) The presiding officer shall serve on the parties and the president an initial order, a brief written statement of the reasons for the decision, within ten days, in accordance with RCW 34.05.485. That statement shall describe the available administrative review procedures specified in the following subparagraph.

(3) Within twenty-one days after service of the initial order, (a) either party may make a written or oral request for administrative review by the president or (b) the president or president's designee may review the matter on his/her own motion. Any such review shall be governed by RCW 34.05.491. If no such review is taken, the initial order shall be the final order.

**Reviser's note:** The bracketed material preceding the section above was supplied by the code reviser's office.

**Reviser's note:** The typographical error in the above section occurred in the copy filed by the agency and appears in the Register pursuant to the requirements of RCW 34.08.040.

**[NEW SECTION]**

**WAC 132J-125-300 SUMMARY SUSPENSION OR REMOVAL** (1) A student who significantly disrupts any college class, function, or hearing and makes it unreasonably difficult to conduct the class, function, or hearing in an orderly manner shall be subject to summary suspension or removal. This summary action may be in addition to any other disciplinary action for the same misconduct.

(2) A faculty member, vice president other than the vice president for marketing and student development, dean, the coordinator or director of student activities, or designee of any of them, who has observed or otherwise has knowledge about such a disruption, may summarily suspend a student and/or order removal of the student from all or part of the college facilities for a period of up to five academic days. The student ordinarily should, but need not be, warned that such action is possible and given a chance to correct the offensive behavior before summary action is taken.

(3) The student shall be notified, verbally and/or by a writing mailed by first class mail to the student's last known address or hand-delivered, of the summary action taken and the time period during which it is effective. The suspension or removal may begin immediately and may be renewed for an additional five day period.

(4) Upon the student's written request, made within five days of the earlier of mailing or personal receipt of notice of the summary action, the suspension or removal shall be reviewed by the vice president for marketing and student development. After such review, the vice president shall issue a written decision continuing, modifying or rescinding the summary action and/or taking any further disciplinary action that he/she deems appropriate.

(5) A student may appeal a summary suspension or removal like any other disciplinary action, by filing an application for an adjudicative proceeding under WAC 132J-125-260. The presiding officer may consolidate this appeal with any related pending matter.

**Reviser's note:** The bracketed material preceding the section above was supplied by the code reviser's office.

**[NEW SECTION]**

WAC 132J-125-310 RECORD-KEEPING (1) The vice president for marketing and student development shall maintain for at least six years the following records of student grievance and disciplinary actions and proceedings:

(a) only initial and final orders in cases where a student's grievance has been sustained or a disciplinary action against a student has been reversed and the student fully exonerated;

(b) the complete records, including all orders, in all other cases where adjudication has been requested;

(c) a list or other summary of all disciplinary actions reported or known to the vice president and not appealed.

(2) Final disciplinary actions shall be entered on student records, provided that the vice president for marketing and student development shall have discretion to remove some or all of that information from a student's record upon the student's request and showing of good cause.

**Reviser's note:** The bracketed material preceding the section above was supplied by the code reviser's office.

**AMENDMENTS**

**AMENDATORY SECTION** (Amending WAC 132J-108-020 filed in 90-22-067 Register 11/5/90 effective 12/6/90):

WAC 132J-108-020 APPOINTMENT OF PRESIDING OFFICERS. The (~~president or president's designee shall designate a~~) presiding officer for an adjudicative proceeding(;) shall be designated by rule or, in the absence of an applicable rule or effective designation, appointed by the president or president's designee. The presiding officer shall be an administrative law judge, a member in good standing of the Washington State Bar Association, a panel of individuals, the president or his or her designee, or any combination of the above. Where more than one individual is designated to be the presiding officer, one person shall be designated by the president or president's designee to make decisions concerning discovery, closure, means of recording adjudicative proceedings, and similar matters.

**AMENDATORY SECTION** (Amending WAC 132J-108-050 filed in 90-22-067 Register 11/5/90 effective 12/6/90):

WAC 132J-108-050 BRIEF ADJUDICATIVE PROCEDURES. This rule is adopted in accordance with RCW 34.05.482 through 34.05.494, the provisions of which are hereby adopted. Brief adjudicative procedures shall be used in all matters related to:

(1) Residency determinations made pursuant to RCW 28B.15.013, conducted by the admissions office;

(2) Challenges to contents of education records;

(3) Student conduct proceedings(;), except as otherwise provided in another rule;

(4) Parking violations;

(5) Outstanding debts owed by students or employees;

(6) Loss of eligibility for participation in institution sponsored athletic events;

(7) Refund of tuition and special fees under WAC 132J-160-010 through 132J-160-050.

**Reviser's note:** RCW 34.05.395 requires the use of underlining and deletion marks to indicate amendments to existing rules. The rule published above varies from its predecessor in certain respects not indicated by the use of these markings.

**REPEALER**

The following chapter of the Washington Administrative Code is repealed:

Chapter 132J-120 WAC [Student Body Rights and Responsibilities]

**Reviser's note:** The brackets and enclosed material in the text of the above repealer occurred in the copy filed by the agency and appear in the Register pursuant to the requirements of RCW 34.08.040.

**WSR 92-15-001****PERMANENT RULES****DEPARTMENT OF AGRICULTURE**

[Filed July 1, 1992, 3:12 p.m.]

Date of Adoption: June 30, 1992.

Purpose: To set into rule minimum letter sizes for apparatus display signs.

Statutory Authority for Adoption: Chapter 17.21 RCW.

Pursuant to notice filed as WSR 92-11-077 on May 20, 1992.

Effective Date of Rule: Thirty-one days after filing.

June 30, 1992

Michael V. Schwisow

Deputy

for C. Alan Pettibone

Director

**NEW SECTION**

WAC 16-228-214 APPARATUS DISPLAY SIGNS. (1) A certified applicator making a landscape application shall display the name and telephone number of the applicator or applicator's employer on any power equipment.

(2) A certified applicator making a right of way application shall display the name and telephone number of the applicator or the applicator's employer and the words "VEGETATION MANAGEMENT APPLICATION".

(3) Apparatus display signs shall be attached to and prominently displayed on the application apparatus and shall be clearly visible.

(4) Lettering of the apparatus display signs shall be, at a minimum, two inches in height and shall be printed in color contrasting to the background.

**WSR 92-15-002****PROPOSED RULES****SUPERINTENDENT OF PUBLIC INSTRUCTION**

[Filed July 2, 1992, 10:42 a.m.]

Original Notice.

Title of Rule: Chapter 392-139 WAC, Finance—Maintenance and operation levies.

Purpose: To change the levy base calculation and the local effort assistance payment schedule as provided in chapter 49, Laws of 1992, and to make minor updates to chapter 392-139 WAC.

Statutory Authority for Adoption: RCW 28A.150.290(2) and 84.52.0531(10).

Statute Being Implemented: Chapter 49, Laws of 1992.

Summary: The levy base is increased by dividing the percent increase in basic education funding per pupil by 55%. The local effort assistance payment schedule is revised to more closely match the timing of levy revenues.

Reasons Supporting Proposal: See Purpose above.

Name of Agency Personnel Responsible for Drafting: Richard M. Wilson, Superintendent of Public Instruction, Olympia, (206) 753-2298; Implementation: Thomas J. Case, Superintendent of Public Instruction, Olympia, (206) 753-6708; and Enforcement: David Moberly, Superintendent of Public Instruction, Olympia, (206) 753-6742.

Name of Proponent: Superintendent of Public Instruction, governmental.

Rule is not necessitated by federal law, federal or state court decision.

Explanation of Rule, its Purpose, and Anticipated Effects: See Purpose and Summary above.

Proposal Changes the Following Existing Rules: See Purpose and Summary above.

No small business economic impact statement is required for this proposal by chapter 19.85 RCW.

Hearing Location: Superintendent of Public Instruction, Old Capitol Building, Wanamaker Conference Room, 2nd Floor, Olympia, Washington 98504-2700, on August 28, 1992, at 9:00 a.m.

Submit Written Comments to: Richard M. Wilson, P.O. Box 47200, Olympia, WA 98504-2700, by August 25, 1992.

Date of Intended Adoption: September 4, 1992.

July 2, 1992  
Judith A. Billings  
Superintendent of  
Public Instruction

**AMENDATORY SECTION** (Amending Order 18, filed 7/19/90, effective 8/19/90)

WAC 392-139-115 DEFINITION—BASIC EDUCATION ALLOCATION. As used in this chapter, "basic education allocation" means the amount of state moneys calculated by the superintendent of public instruction which is the basis for the superintendent's distribution of moneys to school districts for the operation of a basic program of education pursuant to RCW 28A.150.200, et seq., RCW 28A.150.250, and 28A.150.260, chapter 392-121 WAC, and the Biennial Operating Appropriations Act. The amount of a school district's total guaranteed entitlement plus ~~((substitute teacher and))~~ skills center summer program funding as reported on the August Report 1191 before any proration due to less than one hundred percent funding is considered a school district's basic education allocation in determining the school district's excess levy base pursuant to WAC 392-139-310.

**AMENDATORY SECTION** (Amending Order 18, filed 7/19/90, effective 8/19/90)

WAC 392-139-122 DEFINITION—4155 LEARNING ASSISTANCE ((PROGRAM)). As used in this chapter, "4155 Learning assistance ((program))" means the school district general fund revenue account in which is recorded revenue for a learning assistance program pursuant to RCW 28A.165.010 through 28A.165.190, chapter 392-162 WAC, and the Biennial Operating Appropriations Act.

**AMENDATORY SECTION** (Amending Order 18, filed 11/22/89, effective 12/23/89)

WAC 392-139-172 DEFINITION—6176 ((~~INSTRUCTIONAL AID, ESSIA, CHAPTER 2~~)) TARGETED ASSISTANCE, ESSIA, CHAPTER 2, P.L. 100-297. As used in this chapter, "6176 ((~~Instructional aid, ESSIA, chapter 2~~)) Targeted assistance, ESSIA, chapter 2, P.L. 100-297" means the school district general fund revenue account in which are recorded federal revenues authorized under chapter 2 of the Elementary and Secondary School Improvement Act (ESSIA) and distributed by the superintendent of public instruction pursuant to chapter 392-165 WAC.

**AMENDATORY SECTION** (Amending Order 18, filed 11/22/89, effective 12/23/89)

WAC 392-139-310 DETERMINATION OF EXCESS LEVY BASE. The superintendent of public instruction shall calculate each school district's excess levy base as follows:

(1) Sum the following state and federal allocations for the prior school year:

(a) The basic education allocation as defined in WAC 392-139-115 and as reported on the August Report 1191;

(b) The state and federal categorical allocations for the following:

(i) Pupil transportation. Allocations for pupil transportation include allocations for the following accounts:

4199 Transportation - operations; and

4499 Transportation reimbursement - depreciation.

(ii) Handicapped education. Allocations for handicapped education include allocations for the following accounts:

4121 Education of handicapped children;

6124 Handicapped supplemental, EHA, Part B; and

6127 Handicapped deinstitutionalized.

(iii) Education of highly capable students. Allocations for education of highly capable students include allocations identified by account 4174 Highly capable.

(iv) Compensatory education. Allocations for compensatory education include allocations identified by the following accounts:

4155 Learning assistance ((program));

4165 Transitional bilingual;

6151 Remediation, ESSIA, chapter 1;

6153 Migrant, ESSIA, chapter 1;

6162 Refugee programs;

6164 Bilingual, Title VII, P.L. 95-561 (SPI);

6167 Indian education, JOM;

6264 Bilingual, Title VII, P.L. 95-561 (direct); and

6268 Indian education, P.L. 92-318.

(v) Food services. Allocations for food services include allocations identified by the following accounts:

4198 School food services (state);

6198 School food services (federal); and

6998 USDA commodities.

(vi) State-wide block grant programs include allocations identified by the following accounts:

4175 Local education program enhancement; and

6176 ((~~Instructional aid, ESSIA, chapter 2~~)) Targeted assistance, ESSIA, chapter 2, P.L. 100-297.

(c) General federal programs. Allocations for general federal programs identified by the following accounts:

5200 General purpose direct grants, unassigned;

6100 Special purpose, SPI, unassigned;

6138 Secondary vocational education, P.L. 98-524;

6146 Skills center;

6177 Mathematics and science;

6200 Direct special purpose grants; and

6246 Skills center, direct federal grant.

(2) Increase the result obtained in subsection (1) of this section by the following percentage:

(a) For 1992, the percentage increase per full-time equivalent student in the state basic education appropriation between the prior school year and the current school year.

(b) For 1993 and thereafter, the percentage increase per full-time equivalent student in the state basic education appropriation between the prior school year and the current school year as stated in the Operating Appropriations Act divided by 0.55.

(3) Revenue accounts referenced in subsection (1) of this section are from the September 1989 accounting manual for public school districts in the state of Washington, revised 1990.

(4) The dollar amount of revenues for state and federal categorical allocations identified in this section shall come from the following sources:

(a) The following state and federal categorical allocations are taken from the Report 1197 Column A (Annual Allotment Due):

4121 Education of handicapped children;

4155 Learning assistance ((program));

4165 Transitional bilingual;

4174 Highly capable;

4175 Local education program enhancement;

4198 School food services (state);

4199 Transportation - operations;

4499 Transportation reimbursement - depreciation;  
 6124 Handicapped supplemental, EHA, part B;  
 6127 Handicapped deinstitutionalized;  
 6138 Secondary vocational education, P.L. 98-524;  
 6146 Skills center;  
 6151 Remediation, ESSIA, chapter 1;  
 6153 Migrant, ESSIA, chapter 1;  
 6162 Refugee programs;  
 6176 ((Instructional aid, ESSIA, chapter 2)) Targeted assistance, ESSIA, chapter 2, P.L. 100-297;  
 6177 Mathematics and science; and  
 6198 School food services (federal).

(b) The following state and federal allocations are taken from the F-195:

5200 General purpose direct grants, unassigned;  
 6100 Special purpose, SPI, unassigned;  
 6164 Bilingual, Title VII, P.L. 95-561 (SPI);  
 6167 Indian education, JOM;  
 6200 Direct special purpose grants;  
 6246 Skills center, direct federal grant;  
 6264 Bilingual, Title VII, P.L. 95-561 (direct);  
 6268 Indian education, P.L. 92-318; and  
 6998 USDA commodities.

**AMENDATORY SECTION** (Amending Order 18, filed 11/22/89, effective 12/23/89)

**WAC 392-139-675 ALLOCATION OF LOCAL EFFORT ASSISTANCE—1992 CALENDAR YEAR.** For the 1992 calendar year, the superintendent of public instruction shall allocate to each eligible school district its entitlement to local effort assistance according to the following schedule:

January	10.5%
February	10.5%
March	10.5%
April	10.5%
May	6.5%
June	6.5%
July	8.5%
August	8.5%
September	7.5%
October	7.5%
November	5.5%
December	7.5%

**NEW SECTION**

**WAC 392-139-676 ALLOCATION OF LOCAL EFFORT ASSISTANCE—1993 AND THEREAFTER.** For the 1993 calendar year and thereafter, the superintendent of public instruction shall distribute local effort assistance moneys pursuant to the schedule provided in RCW 28A.500.010 (4)(b).

**REPEALER**

The following sections of the Washington Administrative Code are repealed:

**WAC 392-139-243 DEFINITION—LEVY REDUCTION FUNDS—CALENDAR YEAR 1989.**

**WAC 392-139-674 ALLOCATION OF LOCAL EFFORT ASSISTANCE FOR CALENDAR YEAR 1989.**

**WSR 92-15-003**

**ATTORNEY GENERAL OPINION**

**Cite as: AGO 1992 No. 11**

[June 29, 1992]

**WATER DISTRICT COMMISSIONERS—OFFICES AND OFFICERS—EMPLOYERS AND EMPLOYEES—CONFLICT OF INTEREST—CONTRACTS—APPLICABILITY OF CODE OF**

**ETHICS FOR MUNICIPAL OFFICERS TO WATER DISTRICT COMMISSIONER AND PART-TIME EMPLOYEE**

1. A water district commissioner is a municipal officer subject to the Code of Ethics for Municipal Officers, chapter 42.23 RCW. Under RCW 42.23.030 a water district commissioner cannot have a beneficial interest in a contract with the district where the water district's total liability exceeds \$750 in any calendar month.
2. A part-time employee, operating under the control of a board of water commissioners is not a municipal officer subject to the Code of Ethics for Municipal Officers. Thus, the restrictions in RCW 42.23-.030 do not apply to the part-time employee.

Requested by:

The Honorable H. Steward Menefee  
 Grays Harbor County Prosecuting Attorney  
 Post Office Box 550  
 Montesano, Washington 98563

**WSR 92-15-004**

**ATTORNEY GENERAL OPINION**

**Cite as: AGO 1992 No. 12**

[June 29, 1992]

**SECRETARY OF STATE—ELECTIONS—DISTRICTS—BOUNDARIES—LEGISLATORS—REDISTRICTING—BOUNDARIES FOR ELECTION FOR UNEXPIRED TERM OF NEWLY REDISTRICTED LEGISLATIVE DISTRICT**

When the boundaries of a legislative district for the Office of State Senate have been changed by redistricting, a special election for the remainder of the existing senate term should be conducted in the newly redistricted senate district. Candidates for that election must be residents of the new district as required by RCW 42.04.020.

Requested by:

The Honorable Ralph Munro  
 Secretary of State  
 Post Office Box 40220  
 Olympia, Washington 98504-0220

**WSR 92-15-005**

**NOTICE OF PUBLIC MEETINGS**

**SEATTLE COMMUNITY COLLEGES**

[Memorandum—June 29, 1992]

The board of trustees of the Seattle Community College District will not meet in August. Their next regularly scheduled meeting will be at 6:00 p.m. on Tuesday, September 1, 1992, at North Seattle Community College, 9600 College Way, Seattle, WA 98103.

**WSR 92-15-006**  
**RULES COORDINATOR**  
**SOUTH PUGET SOUND**  
**COMMUNITY COLLEGE**  
 [Filed July 2, 1992, 10:46 a.m.]

This letter is to be official notification that Patty Pynch will continue to serve as South Puget Sound Community College's administrative rules coordinator. She can be contacted at: The President's Office, South Puget Sound Community College, 2011 Mottman Road S.W., Olympia, WA 98502, (206) 754-7711 ext. 202.

Kenneth J. Minnaert  
 President

**WSR 92-15-007**  
**PROPOSED RULES**  
**DEPARTMENT OF**  
**SOCIAL AND HEALTH SERVICES**  
**(Public Assistance)**  
 [Filed July 2, 1992, 12:46 p.m.]

Original Notice.

Title of Rule: WAC 388-83-010 Alternative sources for medical care, 388-83-013 Cooperation in securing medical support, and 388-83-014 Good cause not to cooperate in securing medical support.

Purpose: Clarification of language and to provide for exception of H program children automatically eligible up to one year of age from the requirement for support enforcement referral.

Statutory Authority for Adoption: RCW 74.08.090.

Statute Being Implemented: RCW 74.08.090.

Summary: Children automatically eligible for medical assistance are exempted from the requirement of cooperation with support enforcement.

Reasons Supporting Proposal: Clarification of language. Provide for exemption of children up to one year of age from cooperation with support enforcement.

Name of Agency Personnel Responsible for Drafting, Implementation and Enforcement: Joanie Scotson, Medical Assistance Administration, 753-7462.

Name of Proponent: Department of Social and Health Services, governmental.

Rule is not necessitated by federal law, federal or state court decision.

Explanation of Rule, its Purpose, and Anticipated Effects: Same as above.

Proposal Changes the Following Existing Rules: See above.

No small business economic impact statement is required for this proposal by chapter 19.85 RCW.

Hearing Location: OB-2 Auditorium, 12th and Franklin, Olympia, Washington, on August 25, 1992, at 10:00 a.m.

Submit Written Comments to: Troyce Warner, Chief, Office of Issuances, Mailstop 5805, Department of Social and Health Services, Olympia, 98504, TELEFAX 664-0118 or SCAN 366-0118, by August 25, 1992.

Date of Intended Adoption: August 27, 1992.

July 2, 1992  
 Leslie F. James, Director  
 Administrative Services

AMENDATORY SECTION (Amending Order 2126, filed 7/18/84)

WAC 388-83-010 ALTERNATIVE SOURCES FOR MEDICAL CARE. (1) A client shall use all third-party resources ((for medical care)) available to ((the applicant or recipient must be utilized)) a client for the payment of medical care to the fullest possible extent ((in the payment for the medical care prior to participation by)) before the department shall pay for medical care.

(2) The department has the authority to make((s)) agreements with providers of prepaid medical plans. The department shall require an eligible ((recipients)) client who chooses to participate in a prepaid program ((are required)) to ((utilize)) use such providers of service ((exclusively)) except for certain noncovered services for which the department may be responsible under the medical care program. ((See WAC 388-87-010(4).))

(3) Supplementation of medical services shall meet the following limitations:

(a) Supplemental services:

(i) Shall be services beyond those covered by the medical ((assistance)) care programs;

(ii) Shall not be required, implied or otherwise, by the provider in order for the ((recipient)) client to receive services covered by the medical ((assistance)) care program.

(b) Funds for payment of the supplemental services from a source other than the ((recipient)) client are not considered as income available to the ((recipient)) client eligibility purposes if the funds:

(i) ((The funds)) Are paid directly to the provider; and

(ii) ((The funds)) Do not at any time come under the control of the ((recipient)) client.

Reviser's note: RCW 34.05.395 requires the use of underlining and deletion marks to indicate amendments to existing rules. The rule published above varies from its predecessor in certain respects not indicated by the use of these markings.

AMENDATORY SECTION (Amending Order 3312, filed 1/15/92, effective 2/15/92)

WAC 388-83-013 COOPERATION IN SECURING MEDICAL SUPPORT. (1) As a condition of eligibility for Medicaid, the department shall require a client((:)) unless pregnant or a child, under one year of age and automatically eligible for medical assistance, or a client for whom there is a finding of good cause((:)) to cooperate with the department in:

(a) Obtaining medical support, as defined under WAC 388-11-011, for the client or for any other client other than an unborn for whom the client can legally assign rights; and

(b) Identifying and providing information to assist the department in pursuing any liable third party; and

(c) Establishing paternity of the client's child.

(2) The department shall require a Medicaid client to cooperate as described under WAC 388-14-200 (2)(a), (b), (c), (3), (4), (5), (6), (7), (8), (9), and (16), unless:

(a) The client is pregnant; or

(b) There is a finding of good cause under WAC 388-24-111.

(3) The department shall waive such client's cooperation requirements if the department finds the client has good cause for noncooperation as described under WAC 388-83-014.

(4) Unless the department finds good cause for noncooperation under WAC 388-24-111 or 388-83-014, the department shall find the client, who refuses to cooperate under subsection (1) of this section, ineligible to receive Medicaid.

(5) The department shall provide Medicaid to an otherwise eligible client when the person having the legal authority to cooperate on behalf of the client refuses such cooperation.

(6) Effective March 1, 1991, the department shall not establish an obligation to collect a client's birth costs that are:

(a) Paid or expected to be paid by the department; and

(b) Defined under WAC 388-11-011.

(7) The department may seek reimbursement of a client's birth costs covered by available insurance or other liable third party.



**AMENDATORY SECTION** (Amending Order 2809, filed 6/7/89)

WAC 388-83-014 GOOD CAUSE NOT TO COOPERATE IN SECURING MEDICAL CARE SUPPORT. (1) The department shall waive the cooperation requirement under WAC 388-83-013(1), if the client claims and the department determines cooperation is not in the best interest of the:

- (a) Medical care client for whom assignment is made; or
- (b) Person ~~((making the assignment))~~ responsible for cooperating.

(2) The department shall inform a client of the right to claim good cause for not cooperating.

(3) The department shall make a final determination of the existence of good cause using the time limits and exceptions described under WAC 388-84-110.

(4) ~~((The department shall find good cause if the cooperation is not in the best interest of the applicant or recipient/enrollee or the person responsible for cooperating.))~~ Circumstances constituting good cause for a client's noncooperation may include, but are not limited to:

(a) ~~((Cooperation is reasonably anticipated to result in))~~ Physical harm or an emotional impairment substantially affecting the ability to function of the:

(i) ~~((Applicant or recipient/enrollee))~~ Medical care client for whom assignment is made; or

(ii) Person responsible for cooperating.

(b) ~~((That the person for whom support is sought was conceived as a result of))~~ Rape or incest resulting in conception of a person for whom support is sought;

(c) Legal proceedings for adoption are pending;

(d) ~~((The question of whether to place))~~ Active consideration of placement of the child for adoption (is under active consideration); or

(e) ~~((For an AFDC/FIP applicant or recipient/enrollee, if the))~~ A department ~~((finds))~~ finding of good cause for an AFDC/FIP client for not cooperating under WAC 388-24-111 ~~((for))~~ in establishing paternity for a child or a medical care support resource.

(5) ~~((If the client is otherwise eligible.))~~ The department shall not deny, delay, or discontinue medical assistance pending a determination of good cause for a client refusing to cooperate ~~((if the client complies with the requirements to furnish evidence or information)).~~

(6) At each reapplication or eligibility reevaluation, the department shall review all cases in which the department found good cause for refusing to cooperate. If good cause no longer exists, the department shall rescind the decision and require cooperation by the client.

(7) ~~((If))~~ When the department determines good cause does not exist the department shall:

(a) ~~((The department shall))~~ Notify the client, in writing, and afford the client the opportunity to:

(i) Cooperate;

(ii) ~~((Withdraw the application for medical assistance;~~

~~((and)))~~ Have the case closed; or

~~((or))~~ (iii) Request a fair hearing; and

(b) ~~((The department shall deny or))~~ Terminate medical assistance, if the client refuses to cooperate as required under WAC 388-83-013.

are a "sexually violent predator" whether or not a petition is filed or the person is civilly committed. The cost for evaluation by an expert and an expert witness will not have a maximum amount, but the allowable cost will be actual cost incurred by the counties.

Statutory Authority for Adoption: Chapter 71.09 RCW.

Statute Being Implemented: Chapter 71.09 RCW.

Summary: Allows counties and the Attorney General's Office to bill the special commitment center for more evaluations performed by experts on potential violent sexual predators and to bill for more costs regarding expert testimony.

Reasons Supporting Proposal: To expand the cost reimbursement for evaluations and testimony done by experts.

Name of Agency Personnel Responsible for Drafting, Implementation and Enforcement: Dave Weston, Special Commitment Center, Monroe, SCAN 291-2391, off-SCAN 249-2391.

Name of Proponent: Department of Social and Health Services, governmental.

Rule is not necessitated by federal law, federal or state court decision.

Explanation of Rule, its Purpose, and Anticipated Effects: Same as above.

Proposal Changes the Following Existing Rules: See above.

No small business economic impact statement is required for this proposal by chapter 19.85 RCW.

Hearing Location: OB-2 Auditorium, 12th and Franklin, Olympia, Washington, on August 25, 1992, at 10:00 a.m.

Submit Written Comments to: Troyce Warner, Chief, Office of Issuances, Mailstop 5805, Department of Social and Health Services, Olympia, 98504, TELEFAX 664-0118 or SCAN 366-0118, by August 25, 1992.

Date of Intended Adoption: August 27, 1992.

July 2, 1992

Leslie F. James, Director  
Administrative Services

**WSR 92-15-008**  
**PROPOSED RULES**  
**DEPARTMENT OF**  
**SOCIAL AND HEALTH SERVICES**  
**(Institutions)**

[Filed July 2, 1992, 12:51 p.m.]

Original Notice.

Title of Rule: WAC 275-156-010 Definitions, and 275-156-020 Maximum allowable reimbursement for law enforcement cost.

Purpose: To expand definition of "evaluation by expert cost" and to change the cost allowance for "evaluation by expert" and "expert witness" to actual cost. By expanding the definition for "evaluation by expert cost," this will allow counties to request reimbursement for their cost in investigating a person as to whether they

**AMENDATORY SECTION** (Amending Order 3263, filed 10/8/91, effective 11/8/91)

WAC 275-156-010 DEFINITIONS. (1) "Attorney cost" means the fully documented prosecutorial and defense fee directly related to the violent sexual predator civil commitment process. Said fee includes the cost of paralegal services.

(2) "Department" means the department of social and health services.

(3) "Evaluation by expert cost" means a county-incurred service fee as the result of a comprehensive examination and/or a records review of a person:

(a) ~~((Alleged to be a))~~ Investigated for "sexually violent predator" probable cause; ~~((and))~~

(b) Alleged to be a "sexually violent predator" and who has had a petition filed; or

(c) Committed as a "sexually violent predator" and under review for release.

(4) "Incremental cost" means county-incurred efforts or costs that are not otherwise covered and are exclusively attributable to the trial of a person alleged to be a "sexually violent predator."

(5) "Judicial cost" means the costs a county incurs as the result of filing a petition for the civil commitment of a person alleged to be a "sexually violent predator" under chapter 71.09 RCW. This cost is limited to fees for judges which shall include court clerk and bailiff

services, court reporter services, transcript typing and preparation, expert and nonexpert witnesses, jury, and jail facilities.

(6) "Law enforcement cost" means a cost incurred by a police agency investigating issues specific to:

(a) Filing a petition alleging a person is a "sexually violent predator"; or

(b) A hearing to determine if a person is a "sexually violent predator."

(7) "Medical cost" means a county-incurred extraordinary medical expense beyond the routine services of a jail.

(8) "Secretary" means the secretary of social and health services.

(9) "Transportation cost" means the cost a county incurs when transporting a person alleged to be, or having found to be, a "sexually violent predator," to and from a sexual predator program facility.

**AMENDATORY SECTION** (Amending Order 3262 [3263], filed 10/8/91, effective 11/8/91)

WAC 275-156-020 MAXIMUM ALLOWABLE REIMBURSEMENT FOR LAW ENFORCEMENT COST. The department shall reimburse a county for actual costs incurred during the period July 1, 1990, through June 30, 1992, up to the maximum allowable rate as specified:

(1) Attorney cost - Up to forty-nine dollars and forty-one cents per hour;

(2) Evaluation by expert cost - (~~Up to one hundred dollars per hour, not to exceed more than twenty hours~~) Actual costs plus per diem according to state travel policy;

(3) Judicial costs:

(a) Judge - Up to forty-six dollars and five cents per hour. These county costs shall include court clerk and bailiff services;

(b) Court reporters - Up to twenty dollars and seventy-one cents per hour;

(c) Transcript typing and preparation services - Up to four dollars and thirteen cents per page;

(d) Expert witnesses - (~~Up to one hundred dollars per hour~~) Actual costs plus per diem according to state travel policy;

(e) Nonexpert witnesses - Up to thirty-one dollars and thirteen cents per day;

(f) Jury - Thirty-one dollars and thirteen cents per day;

(g) Jail facilities - Thirty dollars per day.

(4) Law enforcement cost - Up to twenty dollars and sixty-six cents per hour;

(5) Medical costs - Up to fifty dollars per day, not to exceed five consecutive days; and

(6) Transportation cost - Up to twenty-six cents per mile, plus the cost of one meal for transporting staff, if transport exceeds eleven consecutive hours.

Reviser's note: The bracketed material preceding the section above was supplied by the code reviser's office.

**WSR 92-15-009  
EMERGENCY RULES  
DEPARTMENT OF  
SOCIAL AND HEALTH SERVICES  
(Public Assistance)**

[Order 3415—Filed July 2, 1992, 12:52 p.m., effective July 3, 1992, 12:01 a.m.]

Date of Adoption: July 2, 1992.

Purpose: Clarification of language and to provide for exception of H program children automatically eligible up to one year of age from the requirement for support enforcement referral.

Citation of Existing Rules Affected by this Order: Amending WAC 388-83-010 Alternative sources for medical care, 388-83-013 Cooperation in securing medical support, and 388-83-014 Good cause not to cooperate in securing medical support.

Statutory Authority for Adoption: RCW 74.08.090.

Pursuant to RCW 34.05.350 the agency for good cause finds that immediate adoption, amendment, or repeal of a rule is necessary for the preservation of the public health, safety, or general welfare, and that observing the time requirements of notice and opportunity to comment upon adoption of a permanent rule would be contrary to the public interest.

Reasons for this Finding: Clarification of language. Provide for exemption of children up to one year of age from cooperation with support enforcement.

Effective Date of Rule: July 3, 1992, 12:01 a.m.

July 2, 1992

Leslie F. James, Director  
Administrative Services

**AMENDATORY SECTION** (Amending Order 2126, filed 7/18/84)

WAC 388-83-010 ALTERNATIVE SOURCES FOR MEDICAL CARE. (1) A client shall use all third-party resources ((for medical care)) available to ((the applicant or recipient must be utilized)) a client for the payment of medical care to the fullest possible extent ((in the payment for the medical care prior to participation by)) before the department shall pay for medical care.

(2) The department has the authority to make((s)) agreements with providers of prepaid medical plans. The department shall require an eligible ((recipients)) client who chooses to participate in a prepaid program ((are required)) to ((utilize)) use such providers of service ((exclusively)) except for certain noncovered services for which the department may be responsible under the medical care program. ((See WAC 388-87-010(4).))

(3) Supplementation of medical services shall meet the following limitations:

(a) Supplemental services:

(i) Shall be services beyond those covered by the medical ((assistance)) care programs;

(ii) Shall not be required, implied or otherwise, by the provider in order for the ((recipient)) client to receive services covered by the medical ((assistance)) care program.

(b) Funds for payment of the supplemental services from a source other than the ((recipient)) client are not considered as income available to the ((recipient)) client eligibility purposes if the funds:

(i) ((The funds)) Are paid directly to the provider, and

(ii) ((The funds)) Do not at any time come under the control of the ((recipient)) client.

Reviser's note: RCW 34.05.395 requires the use of underlining and deletion marks to indicate amendments to existing rules. The rule published above varies from its predecessor in certain respects not indicated by the use of these markings.

**AMENDATORY SECTION** (Amending Order 3312, filed 1/15/92, effective 2/15/92)

WAC 388-83-013 COOPERATION IN SECURING MEDICAL SUPPORT. (1) As a condition of eligibility for Medicaid, the department shall require a client((;)) unless pregnant or a child, under one year of age and automatically eligible for medical assistance, or a

client for whom there is a finding of good cause(;) to cooperate with the department in:

(a) Obtaining medical support, as defined under WAC 388-11-011, for the client or for any other client other than an unborn for whom the client can legally assign rights; and

(b) Identifying and providing information to assist the department in pursuing any liable third party; and

(c) Establishing paternity of the client's child.

(2) The department shall require a Medicaid client to cooperate as described under WAC 388-14-200 (2)(a), (b), (c), (3), (4), (5), (6), (7), (8), (9), and (16), unless:

(a) The client is pregnant; or

(b) There is a finding of good cause under WAC 388-24-111.

(3) The department shall waive such client's cooperation requirements if the department finds the client has good cause for noncooperation as described under WAC 388-83-014.

(4) Unless the department finds good cause for noncooperation under WAC 388-24-111 or 388-83-014, the department shall find the client, who refuses to cooperate under subsection (1) of this section, ineligible to receive Medicaid.

(5) The department shall provide Medicaid to an otherwise eligible client when the person having the legal authority to cooperate on behalf of the client refuses such cooperation.

(6) Effective March 1, 1991, the department shall not establish an obligation to collect a client's birth costs that are:

(a) Paid or expected to be paid by the department; and

(b) Defined under WAC 388-11-011.

(7) The department may seek reimbursement of a client's birth costs covered by available insurance or other liable third party.

**AMENDATORY SECTION** (Amending Order 2809, filed 6/7/89)

**WAC 388-83-014 GOOD CAUSE NOT TO COOPERATE IN SECURING MEDICAL CARE SUPPORT.** (1) The department shall waive the cooperation requirement under WAC 388-83-013(1), if the client claims and the department determines cooperation is not in the best interest of the:

(a) Medical care client for whom assignment is made; or

(b) Person ~~((making the assignment))~~ responsible for cooperating.

(2) The department shall inform a client of the right to claim good cause for not cooperating.

(3) The department shall make a final determination of the existence of good cause using the time limits and exceptions described under WAC 388-84-110.

(4) ~~((The department shall find good cause if the cooperation is not in the best interest of the applicant or recipient/enrollee or the person responsible for cooperating.))~~ Circumstances constituting good cause for a client's noncooperation may include, but are not limited to:

(a) ~~((Cooperation is reasonably anticipated to result in))~~ Physical harm or an emotional impairment substantially affecting the ability to function of the:

(i) ~~((Applicant or recipient/enrollee))~~ Medical care client for whom assignment is made; or

(ii) Person responsible for cooperating.

(b) ~~((That the person for whom support is sought was conceived as a result of))~~ Rape or incest resulting in conception of a person for whom support is sought;

(c) Legal proceedings for adoption are pending;

(d) ~~((The question of whether to place))~~ Active consideration of placement of the child for adoption ((is under active consideration)); or

(e) ~~((For an AFDC/FIP applicant or recipient/enrollee, if the))~~ A department ((finds)) finding of good cause for an AFDC/FIP client for not cooperating under WAC 388-24-111 ((for)) in establishing paternity for a child or a medical care support resource.

(5) ~~((If the client is otherwise eligible,))~~ The department shall not deny, delay, or discontinue medical assistance pending a determination of good cause for a client refusing to cooperate ((if the client complies with the requirements to furnish evidence or information)).

(6) At each reapplication or eligibility reevaluation, the department shall review all cases in which the department found good cause for refusing to cooperate. If good cause no longer exists, the department shall rescind the decision and require cooperation by the client.

(7) ~~((If))~~ When the department determines good cause does not exist the department shall:

(a) ~~((The department shall))~~ Notify the client, in writing, and afford the client the opportunity to:

(i) Cooperate;

(ii) ~~((Withdraw the application for medical assistance; (iii)))~~ Have the case closed; or

~~((iv))~~ (iii) Request a fair hearing; and

(b) ~~((The department shall deny or))~~ Terminate medical assistance, if the client refuses to cooperate as required under WAC 388-83-013.

**WSR 92-15-010**

**EMERGENCY RULES**

**DEPARTMENT OF FISHERIES**

[Order 92-42—Filed July 2, 1992, 3:59 p.m.]

Date of Adoption: July 2, 1992.

Purpose: Personal use rules.

Citation of Existing Rules Affected by this Order:  
Repealing WAC 220-56-25500M.

Statutory Authority for Adoption: RCW 75.08.080.

Pursuant to RCW 34.05.350 the agency for good cause finds that immediate adoption, amendment, or repeal of a rule is necessary for the preservation of the public health, safety, or general welfare, and that observing the time requirements of notice and opportunity to comment upon adoption of a permanent rule would be contrary to the public interest.

Reasons for this Finding: A limited number of halibut are available for harvest in Catch Area 3 and that portion of Catch Area 4 west of the Bonilla Tatoosh line for a one day fishery.

Effective Date of Rule: Immediately.

July 2, 1992  
Judith Merchant  
Deputy  
for Robert Turner  
Director

### NEW SECTION

**WAC 220-56-25500N HALIBUT—SEASONS.**  
Notwithstanding the provisions of WAC 220-56-255, effective immediately until further notice it is unlawful to take, fish for or possess halibut taken for personal use except as follows:

(1) Those waters of Catch Areas 1, and 2, are open May 1, 1992 seven days a week.

(2) Those waters of Catch Areas 3 and 4 west of the Bonilla Tatoosh Line are open 12:01 a.m. Friday July 3 to 11:59 p.m. July 3, 1992.

(3) Those waters of Catch Area 4 east of the Bonilla Tatoosh Line and Catch Areas 5 through 13 are open May 9, 1992 seven days a week.

### REPEALER

The following section of the Washington Administrative Code is repealed:

**WAC 220-56-25500M HALIBUT—SEASONS.**  
(92-35)

**WSR 92-15-011**  
**PERMANENT RULES**  
**FOREST PRACTICES BOARD**

[Filed July 2, 1992, 4:18 p.m.]

Date of Adoption: June 26, 1992.

Purpose: To modify forest practices rules, in order to protect public resources while maintaining a viable timber industry.

Citation of Existing Rules Affected by this Order: Repealing WAC 222-16-020; and amending WAC 222-12-040, 222-16-010, 222-16-030, 222-16-050, 222-24-010, 222-24-020, 222-24-025, 222-24-030, 222-24-035, 222-24-040, 222-24-050, 222-24-060, 222-30-010, 222-30-020, 222-30-040, 222-30-050, 222-30-060, 222-30-070, 222-30-090, 222-30-100, 222-38-010, and 222-38-020.

Statutory Authority for Adoption: RCW 76.09.040, 76.09.050, and chapter 34.05 RCW.

Pursuant to notice filed as WSR 92-07-093 on April 1, 1992; and WSR 92-11-069 on May 20, 1992.

Changes Other than Editing from Proposed to Adopted Version: WAC 222-16-010 General definitions, modifies definition of "low impact harvest" in two ways: Adds "compaction" to "disturbance of soils and vegetation" in effects to be minimized; and deletes the nonexclusive list of low impact harvest methods and instead

provides for the Department of Natural Resources, in consultation with the Department of Ecology, to determine such equipment, methods or systems.

WAC 222-16-035 Wetland typing system, eliminates the restriction on the requirement for delineation to "typed" wetlands by deleting the word "typed" in the phrase "delineation of typed wetlands" in the third sentence; changes "wetland replacement or substitution" to "wetland replacement by substitution or enhancement" in two places; limits the requirement for accurate delineation to the area of the wetland proposed to be filled; and provides for identifying the innermost edge of a wetland management zone as the delineation of the wetland edge as well as the point where crown cover changes from less than 30% to 30% or more.

WAC 222-16-050 Classes of forest practices, in the definition of Class I, deletes "appropriate Indian tribes" in the informational list of agencies that may require hydraulics project approval for removing beaver structures from culverts, WAC 222-16-050 (3)(s).

WAC 222-16-080 Critical wildlife habitats (state) and critical habitat (federal) of threatened and endangered species, subsection (1)(h) northern spotted owl, in the last sentence of the first paragraph, adds "the nest or breeding grounds of" between "known to contain" and "Status 1, 2, or 3 spotted owls"; subsection (4), deletes "by the Wildlife Commission" from the end of the second sentence, thus extending to listing by the Secretary of Interior the specified occasions for submitting a proposed [proposal] of critical wildlife habitats; subsection (6)(a), specifies that interim designations of critical wildlife habitat expire "for a given species," not all species when certain conditions exist; and subsection (6)(a)(i), adds the effective date of "substantive rules on the species" as the time for expiration of interim designations of critical wildlife habitat.

WAC 222-22-070 Prescription recommendation, subsection (1), the language regarding qualifications of members of the team is made consistent with similar provisions for the teams for Level 1 and Level 2 assessments (WAC 222-22-050 and 222-22-060).

WAC 222-22-100 Application review prior to watershed analysis, in the first sentence, substitutes "methodology" for "but," correcting an earlier editing error.

WAC 222-24-020 Road location, in subsection (2)(c), deletes "not" so that approximate determination is required for the purpose of avoidance of wetlands in design and construction of roads; "replacement" is elaborated by changing to "replacement by substitution or enhancement"; and removes the requirement for delineation of wetlands when subgrade widths should be narrowed to minimize impacts.

WAC 222-24-025 Road design, subsection (8), limits the requirement for at least 18 inch relief culverts to western Washington and requires at least 15 inch relief culverts in eastern Washington; subsection (10), filling and draining wetlands: Changes "replacement or substitution" to "replacement by substitution or enhancement" in two places; specifies that replacement of lost wetland area applies to creation of new wetlands; specifies that the objective of replacement of lost wetland area applies

where creation of new wetlands is proposed; and provides an objective for enhancement of wetlands.

WAC 222-24-040 Water crossing structures, in subsection (2)(a), limits minimum 18 inch culvert diameter to western Washington and requires minimum 15 inch culvert diameter in eastern Washington.

WAC 222-30-020(3) Western Washington riparian management zones, when riparian management zones and wetlands or wetland management zones overlap, changes the provision that the "more restrictive requirements" apply to the "requirement which best protects public resources" applies; and subdivision (e), in addition to riparian management zones, includes wetlands management zones as situations where the requirement for leaving trees in riparian management zones might be reduced by half for small harvest units.

WAC 222-30-020(4) Eastern Washington riparian management zones, when riparian management zones and wetlands or wetland management zones overlap, changes the provision that the "more restrictive requirements" apply to the "requirement which best protects public resources" applies; and in subdivision (d), in addition to riparian management zones, includes wetland management zones as situations where the requirement for leaving trees in riparian management zones might be reduced by half for small harvest units.

WAC 222-30-020(7) Wetland management zones (WMZ), when a wetland management zone overlaps a riparian management zone, changes the provision that the "more restrictive requirements" apply to the "requirement which best protects public resources" applies; in subdivision (a), prescribes wetland management zone width for bogs and fens of 1/4 to 1/2 acre; and in subdivision (f), in addition to wetland management zones, includes riparian management zones as situations where the requirement for leaving trees in wetland management zones might be reduced by half for small harvest units.

WAC 220-30-020(8) Nonforested wetlands (type A or B), removes the 30% crown closure criterion for identifying forested wetland areas within the boundaries of Type A or B wetlands.

WAC 222-30-020(11) Wildlife reserve tree management, provides that in situations which create "significant hazard to overhead power lines" there is no obligation to leave wildlife reserve trees; in subdivision (a), makes it a landowner option whether Type 1 wildlife reserve trees are to be counted as wildlife reserve trees or green recruitment trees; in subdivision (e), changes the requirement that no point within a harvest unit shall be more than 800 feet from a "wildlife reserve tree and green recruitment tree area" to a "wildlife reserve tree or green recruitment tree area" and changes landowner's discretion for "location of . . . reserve trees" to "selection of recruitment trees"; and in subdivision (f), specifies that the wildlife reserve tree management plan which might modify the distribution of wildlife reserve tree retention areas is a plan "proposed by the landowner."

WAC 222-30-070 Tractor and wheeled skidding systems, in subsection (5), changes moisture condition in

which tractor and wheeled skidders are prohibited from "hydric (wetland) soils" to "saturates soils."

WAC 222-30-090 Postharvest site preparation, in subsection (1), removes "wetlands" from the exceptions to the requirement to cut, slash, or otherwise treat competing vegetation and small suppressed trees for site preparation.

WAC 222-30-100 Slash disposal, in subsection (5)(c), excludes forest wetlands from the wetlands in which fire trails are prohibited; expresses a preference for hand constructed fire trails in forest wetlands; and adds the requirement to minimize width and excavation when it is necessary to construct fire trails with machines.

WAC 222-38-020 Handling, storage, and application of pesticides, in subsections (5)(a) and (b), changes the exception for keeping pesticides out of Type 4 and 5 Waters from those with "no evidence of surface water" to those with "no surface water"; and in subsection (6), changes the exception for avoiding drift causing direct entry of pesticides into Type 4 and 5 Waters from those with "no evidence of surface water" to those with "no surface water."

WAC 222-38-030 Handling, storage, and application of fertilizers, in subsection (4)(e), for aerial application of fertilizer: Units to be fertilized are to be identified "with appropriately marked aerial photos or detailed planimetric maps" instead of "marking them" so they are visible from the air" and changes the requirement for a pre-application overflight "by the pilot and a responsible agent of the landowner" to "by the pilot with the marked photos or maps"; and in subsection (5), changes the exception for preventing fertilizer from entering Type 4 and 5 Waters from those with "no evidence of surface water" to those with "no surface water."

WAC 222-38-040 Handling, storage, and application of other forest chemicals, in subsection (1), changes the exception for keeping other forest chemicals out of Type 4 and 5 Waters from those with "no evidence of surface water" to those with "no surface water."

Other Findings Required by Other Provisions of Law as Precondition to Adoption or Effectiveness of Rule: The Forest Practices Board concludes that under RCW 34.05.340 the adopted rule is not substantially different from the rule proposed in WSR 92-11-069.

Effective Date of Rule: Thirty-one days after filing.

July 2, 1992

Patricia Harper  
for Brian Boyle

Commissioner of Public Lands

**AMENDATORY SECTION** (Amending Order 535, filed 11/16/87, effective 1/1/88)

WAC 222-12-040 \*ALTERNATE PLANS. All forest practice operations must comply with the act and further with the rules and regulations promulgated pursuant to the act, unless an alternate plan has been approved by the department. An applicant may submit an alternate plan for any or all of the activities described in the application. The department may approve an application which departs from the specific provisions of

chapters (~~222-24~~) 222-22 through 222-38 WAC, provided that the plan must, in the determination of the department, equal or exceed the protection of public resources as provided in the Forest Practices Act and rules and regulations. The department shall provide an opportunity for comment to the departments of fisheries, wildlife, and ecology, other state agencies, and affected Indian tribes prior to approval of any alternate plan.

**NEW SECTION**

**WAC 222-12-046 CUMULATIVE EFFECTS.** The purpose of this section is to identify how the forest practices rules address changes to the environment caused by the interaction of natural ecosystem processes with the effects of two or more forest practices. This interaction is referred to as "cumulative effects." The following approaches have been taken:

(1) Title 222 WAC establishes minimum standards for all forest practices, regardless of the class of forest practice application.

(2) Forest practices which have a potential for a substantial impact on the environment are classified as Class IV-Special or Class IV-General by WAC 222-16-050 and receive an evaluation as to whether or not a detailed statement must be prepared pursuant to chapter 43.21C RCW.

(3) Certain rules are designed to focus on specific aspects of cumulative effects of forest practices. For example:

(a) WAC 222-08-035 requires continuing review of the forest practices regulations and voluntary processes and adopts the concept of adaptive management. WAC 222-12-045 also adopts adaptive management.

(b) WAC 222-12-040 allows alternate plans that equal or exceed the protection of public resources as provided in the act and rule.

(c) WAC 222-24-050(1) allows the department to require road maintenance and abandonment plans for those drainages or road systems the department determines based on physical evidence to have a potential to damage public resources.

(d) WAC 222-30-025 addresses harvest unit size and separation requirements.

(e) Chapter 222-22 WAC addresses cumulative effects on the public resources of fish, water, and capital improvements of the state or its political subdivisions.

(f) Chapter 222-46 WAC establishes the enforcement policy for forest practices.

(4) The board is considering measures to further protect cultural resources and wildlife resources. The board shall continue consultation with the departments of ecology, fisheries, wildlife, natural resources, forest landowners, and federally recognized tribes on these resource issues.

**AMENDATORY SECTION** (Amending WSR 92-03-028, filed 1/8/92, effective 2/8/92)

**WAC 222-16-010 GENERAL DEFINITIONS.\*** Unless otherwise required by context, as used in these regulations:

"Act" means the Forest Practices Act, chapter 76.09 RCW.

"Affected Indian tribe" means any federally recognized Indian tribe that requests in writing from the department information on forest practices applications and notification filed on specified areas.

"Appeals board" means the forest practices appeals board established in the act.

"Area of resource sensitivity" means areas identified in accordance with WAC 222-22-050 (2)(d) or 222-22-060(2).

"Board" means the forest practices board established by the act.

"Bog" means wetlands which have the following characteristics: Peat soils 16 inches or more in depth (except over bedrock); and vegetation such as sphagnum moss, labrador tea, bog laurel, bog rosemary, sundews, and sedges; bogs may have an overstory of spruce and may be associated with open water.

"Borrow pit" shall mean an excavation site outside the limits of construction to provide material necessary to that construction, such as fill material for the embankments.

"Chemicals" means substances applied to forest lands or timber (~~to accomplish specific purposes and includes pesticides, insecticides, rodenticides, plant-growth regulators, fungicides, fertilizers, desiccants, fire retardants when used in controlled burning, repellents, oil, dust-control agents (other than water), salt and other materials that may present hazards to the environment~~) including pesticides, fertilizers, and other forest chemicals.

"Clearcut" means a harvest method in which the entire stand of trees is removed in one timber harvesting operation. Except as provided in WAC 222-30-110, an area remains clearcut until:

It meets the minimum stocking requirements under WAC 222-34-010(2) or 222-34-020(2); and

The largest trees qualifying for the minimum stocking levels have survived on the area for five growing seasons or, if not, they have reached an average height of four feet.

"Commercial tree species" means any species which is capable of producing a merchantable stand of timber on the particular site, or which is being grown as part of a Christmas tree or ornamental tree-growing operation.

"Completion of harvest" means the latest of:

Completion of removal of timber from the portions of forest lands harvested in the smallest logical unit that will not be disturbed by continued logging or an approved slash disposal plan for adjacent areas; or

Scheduled completion of any slash disposal operations where the department and the applicant agree within 6 months of completion of yarding that slash disposal is necessary or desirable to facilitate reforestation and agree to a time schedule for such slash disposal; or

Scheduled completion of any site preparation or rehabilitation of adjoining lands approved at the time of approval of the application or receipt of a notification: PROVIDED, That delay of reforestation under this paragraph is permitted only to the extent reforestation would prevent or unreasonably hinder such site preparation or rehabilitation of adjoining lands.

"Constructed wetlands" means those wetlands voluntarily developed by the landowner. Constructed wetlands do not include wetlands created, restored, or enhanced as part of a mitigation procedure or wetlands inadvertently created as a result of current or past practices including, but not limited to: Road construction, landing construction, railroad construction, or surface mining.

"Contamination" means the introducing into the atmosphere, soil, or water; sufficient quantities of substances as may be injurious to public health, safety or welfare, or to domestic, commercial, industrial, agriculture or recreational uses, or to livestock, wildlife, fish or other aquatic life.

"Conversion option harvest plan" means a voluntary plan developed by the landowner and approved by the local government entity indicating the limits of harvest areas, road locations, and open space.

"Conversion to a use other than commercial timber operation" shall mean a bona fide conversion to an active use which is incompatible with timber growing.

"Critical ((wildlife)) habitat (federal)" means the habitat of any threatened or endangered species((, as such habitat is established by the board in the forest practices board manual, or other situations as identified by the board, after consultation with the department of wildlife, where specific management practices are needed to prevent critical wildlife habitat destruction)) designated as critical habitat by the United States Secretary of the Interior under Sections 3(5)(A) and 4(a)(3) of the Federal Endangered Species Act.

"Critical wildlife habitat (state)" means those habitats designated by the board in accordance with WAC 222-16-080.

"Cultural resources" means archaeological and historic sites and artifacts and traditional religious, ceremonial and social uses and activities of affected Indian tribes.

"Cumulative effects" means the changes to the environment caused by the interaction of natural ecosystem processes with the effects of two or more forest practices.

"Debris" means woody vegetative residue less than 3 cubic feet in size resulting from forest practice activities which would reasonably be expected to cause significant damage to a public resource.

"Department" means the department of natural resources.

"Eastern Washington" means the lands of the state lying east of an administrative line which approximates the change from the Western Washington timber types to the Eastern Washington timber types described as follows:

Beginning at the International Border and Okanogan National Forest boundary at the N1/4 corner Section 6, T. 40N, R. 24E., W.M., south and west along the Pasayten Wilderness boundary to the west line of Section 30, T. 37N, R. 19E.,

Thence south on range line between R. 18E. and R. 19E., to the Lake Chelan-Sawtooth Wilderness at Section 31, T. 35N, R. 19E.,

Thence south and east along the eastern wilderness boundary of Lake Chelan-Sawtooth Wilderness to the west line of Section 18, T. 31N, R. 19E. on the north shore of Lake Chelan,

Thence south on the range line between R. 18E. and R. 19E. to the SE corner of T. 28N, R. 18E.,

Thence west on the township line between T. 27N, and T. 28N to the NW corner of T. 27N, R. 17E.,

Thence south on range line between R. 16E. and R. 17E. to the Alpine Lakes Wilderness at Section 31, T. 26N, R. 17E.,

Thence south along the eastern wilderness boundary to the west line of Section 6, T. 22N, R. 17E.,

Thence south on range line between R. 16E. and R. 17E. to the SE corner of T. 22N, R. 16E.,

Thence west along township line between T. 21N, and T. 22N to the NW corner of T. 21N, R. 15E.,

Thence south along range line between R. 14E. and R. 15E. to SW corner of T. 20N, R. 15E.,

Thence east along township line between T. 19N, and T. 20N to the SW corner of T. 20N, R. 16E.,

Thence south along range line between R. 15E. and R. 16E. to the SW corner of T. 18N, R. 16E.,

Thence west along township line between T. 17N, and T. 18N to the SE corner of T. 18N, R. 14E.,

Thence south along range line between T. 14E. and R. 15E. to the SW corner of T. 14N, R. 15E.,

Thence south and west along Wenatchee National Forest Boundary to the NW corner of T. 12N, R. 14E.,

Thence south along range line between R. 13E. and R. 14E. to SE corner of T. 10N, R. 13E.,

Thence west along township line between T. 9N, and T. 10N to the NW corner of T. 9N, R. 12E.,

Thence south along range line between R. 11E. and R. 12E. to SE corner of T. 8N, R. 11E.,

Thence west along township line between T. 7N, and T. 8N to the Gifford Pinchot National Forest Boundary,

Thence south along Forest Boundary to SE corner of Section 33, T. 7N, R. 11E.,

Thence west along township line between T. 6N, and T. 7N to SE corner of T. 7N, R. 9E.,

Thence south along Skamania-Klickitat County line to Oregon-Washington state line.

"End hauling" means the removal and transportation of excavated material, pit or quarry overburden, or landing or road cut material from the excavation site to a deposit site not adjacent to the point of removal.

"Erodible soils" means those soils exposed or displaced by a forest practice operation, that would be readily moved by water.

"Even-aged harvest methods" means the following harvest methods:

Clearcuts;

Seed tree harvests in which twenty or fewer trees per acre remain after harvest;

Shelterwood regeneration harvests in which twenty or fewer trees per acre remain after harvest;

Group or strip shelterwood harvests creating openings wider than two tree heights, based on dominant trees;

Shelterwood removal harvests which leave fewer than one hundred fifty trees per acre which are at least five years old or four feet in average height;

Partial cutting in which fewer than fifty trees per acre remain after harvest;

Overstory removal when more than five thousand board feet per acre is removed and fewer than fifty trees



per acre at least ten feet in height remain after harvest; and

Other harvesting methods designed to manage for multiple age classes in which six or fewer trees per acre remain after harvest.

Except as provided above for shelterwood removal harvests and overstory removal, trees counted as remaining after harvest shall be at least ten inches in diameter at breast height and have at least the top one-third of the stem supporting green, live crowns. Except as provided in WAC 222-30-110, an area remains harvested by even-aged methods until it meets the minimum stocking requirements under WAC 222-30-010(2) or 222-34-020(2) and the largest trees qualifying for the minimum stocking levels have survived on the area for five growing seasons or, if not, they have reached an average height of four feet.

"Fen" means wetlands which have the following characteristics: Peat soils 16 inches or more in depth (except over bedrock); and vegetation such as certain sedges, hardstem bulrush and cattails; fens may have an overstory of spruce and may be associated with open water.

"Fertilizers" means any substance or any combination or mixture of substances used principally as a source of plant food or soil amendment.

"Fill" means the placement of earth material or aggregate for road or landing construction or other similar activities. Fill does not include the growing or harvesting of timber including, but not limited to, slash burning, site preparation, reforestation, precommercial thinning, intermediate or final harvesting, salvage of trees, brush control, or fertilization.

"Flood level - 50 year." For purposes of field interpretation of these regulations, the 50-year flood level shall be considered to refer to a vertical elevation measured from the ordinary high-water mark which is 1.25 times the vertical distance between the average stream bed and the ordinary high-water mark, and in horizontal extent shall not exceed 2 times the channel width measured on either side from the ordinary high-water mark, unless a different area is specified by the department based on identifiable topographic or vegetative features or based on an engineering computation of flood magnitude that has a 2 percent chance of occurring in any given year. The 50-year flood level shall not include those lands that can reasonably be expected to be protected from flood waters by flood control devices maintained by or under license from the federal government, the state, or a political subdivision of the state.

"Forest land" means all land which is capable of supporting a merchantable stand of timber and is not being actively used for a use which is incompatible with timber growing.

"Forest land owner" shall mean any person in actual control of forest land, whether such control is based either on legal or equitable title, or on any other interest entitling the holder to sell or otherwise dispose of any or all of the timber on such land in any manner: PROVIDED, That any lessee or other person in possession of forest land without legal or equitable title to such land shall be excluded from the definition of "forest land owner" unless such lessee or other person has the right to sell or

otherwise dispose of any or all of the timber located on such forest land.

"Forest practice" means any activity conducted on or directly pertaining to forest land and relating to growing, harvesting, or processing timber, including but not limited to:

- Road and trail construction;
- Harvesting, final and intermediate;
- Precommercial thinning;
- Reforestation;
- Fertilization;
- Prevention and suppression of diseases and insects;
- Salvage of trees; and
- Brush control.

"Forest practice" shall not include: Forest species seed orchard operations and intensive forest nursery operations; or preparatory work such as tree marking, surveying and road flagging; or removal or harvest of incidental vegetation from forest lands such as berries, ferns, greenery, mistletoe, herbs, mushrooms, and other products which cannot normally be expected to result in damage to forest soils, timber or public resources.

"Forest trees" excludes trees cultivated by agricultural methods in growing cycles shorter than ten years: PROVIDED, That Christmas trees are forest trees and: PROVIDED FURTHER, That this exclusion applies only to trees planted on land that was not in forest use immediately before the trees were planted and before the land was prepared for planting the trees.

"Green recruitment trees" means those trees left after harvest for the purpose of becoming future wildlife reserve trees under WAC 222-30-020(11).

"Herbicide" means any substance or mixture of substances intended to prevent, destroy, repel, or mitigate any tree, bush, weed or algae and other aquatic weeds.

"Historic site" includes:

Sites, areas and structures or other evidence of human activities illustrative of the origins, evolution and development of the nation, state or locality; or

Places associated with a personality important in history; or

Places where significant historical events are known to have occurred even though no physical evidence of the event remains.

"Identified watershed processes" means the following components of natural ecological processes that may in some instances be altered by forest practices in a watershed:

- Mass wasting;
- Surface and road erosion;
- Seasonal flows including hydrologic peak and low flows and annual yields (volume and timing);
- Large organic debris;
- Shading; and
- Stream bank and bed stability.

"Insecticide" means any substance or mixture of substances intended to prevent, destroy, repel, or mitigate any insect, other arthropods or mollusk pests.

"Interdisciplinary team" (ID Team) means a group of varying size comprised of individuals having specialized expertise, assembled by the department to respond to



technical questions associated with a proposed forest practice activity.

"Islands" means any island surrounded by salt water in Kitsap, Mason, Jefferson, Pierce, King, Snohomish, Skagit, Whatcom, Island, or San Juan counties.

"Limits of construction" means the area occupied by the completed roadway or landing, including the cut bank, fill slope, and the area cleared for the purpose of constructing the roadway or landing.

"Load bearing portion" means that part of the road, landing, etc., which is supportive soil, earth, rock or other material directly below the working surface and only the associated earth structure necessary for support.

"Local government entity" means the governments of counties and the governments of cities and towns as defined in chapter 35.01 RCW.

"Low impact harvest" means use of any logging equipment, methods, or systems that minimize compaction or disturbance of soils and vegetation during the yarding process. The department shall determine such equipment, methods or systems in consultation with the department of ecology.

"Merchantable stand of timber" means a stand of trees that will yield logs and/or fiber:

Suitable in size and quality for the production of lumber, plywood, pulp or other forest products.

Of sufficient value at least to cover all the costs of harvest and transportation to available markets.

"Notice to comply" means a notice issued by the department pursuant to RCW 76.09.090 of the act and may require initiation and/or completion of action necessary to prevent, correct and/or compensate for material damage to public resources which resulted from forest practices.

"Operator" shall mean any person engaging in forest practices except an employee with wages as his sole compensation.

"Ordinary high-water mark" means the mark on the shores of all waters, which will be found by examining the beds and banks and ascertaining where the presence and action of waters are so common and usual, and so long continued in all ordinary years, as to mark upon the soil a character distinct from that of the abutting upland, in respect to vegetation: PROVIDED, That in any area where the ordinary high-water mark cannot be found, the ordinary high-water mark adjoining saltwater shall be the line of mean high tide and the ordinary high-water mark adjoining freshwater shall be the line of mean high-water.

"Other forest chemicals" means fire retardants when used to control burning (other than water), nontoxic repellents, oil, dust-control agents (other than water), salt, and other chemicals used in forest management, except pesticides and fertilizers, that may present hazards to the environment.

"Park" means any park included on the parks register maintained by the department pursuant to WAC 222-20-100(2). Developed park recreation area means any park area developed for high density outdoor recreation use.

"Partial cutting" means the removal of a portion of the merchantable volume in a stand of timber so as to

leave an uneven-aged stand of well-distributed residual, healthy trees that will reasonably utilize the productivity of the soil. Partial cutting does not include seedtree or shelterwood or other types of regeneration cutting.

"Pesticide" means any insecticide, herbicide, fungicide, or rodenticide but does not include nontoxic repellents or other forest chemicals.

"Plantable area" is an area capable of supporting a commercial stand of timber excluding lands devoted to permanent roads, utility rights-of-way, that portion of riparian management zones where scarification is not permitted, and any other area devoted to a use incompatible with commercial timber growing.

"Power equipment" means all machinery operated with fuel burning or electrical motors, including heavy machinery, chain saws, portable generators, pumps, and powered backpack devices.

"Public resources" means water, fish, and wildlife and in addition shall mean capital improvements of the state or its political subdivisions.

"Rehabilitation" means the act of renewing, or making usable and reforesting forest land which was poorly stocked or previously nonstocked with commercial species.

"Relief culvert" means a structure to relieve surface runoff from roadside ditches to prevent excessive buildup in water volume and velocity.

"Resource characteristics" means the following specific measurable characteristics of fish, water, and capital improvements of the state or its political subdivisions:

For fish and water:

Physical fish habitat, including temperature and turbidity;

Turbidity in hatchery water supplies; and

Turbidity and volume for areas of water supply.

For capital improvements of the state or its political subdivisions:

Physical or structural integrity.

If the methodology is developed and added to the manual to analyze the cumulative effects of forest practices on other characteristics of fish, water, and capital improvements of the state or its subdivisions, the board shall amend this list to include these characteristics.

"Riparian management zone" means a specified area alongside Type 1, 2 and 3 Waters where specific measures are taken to protect water quality and fish and wildlife habitat.

"Rodenticide" means any substance or mixture of substances intended to prevent, destroy, repel, or mitigate rodents or any other vertebrate animal which the director of the state department of agriculture may declare by regulation to be a pest.

"Salvage" means the removal of snags, down logs, windthrow, or dead and dying material.

"Scarification" means loosening the topsoil and/or disrupting the forest floor in preparation for regeneration.

"Side casting" means the act of moving excavated material to the side and depositing such material within the limits of construction or dumping over the side and outside the limits of construction.

"Site preparation" means those activities associated with the removal of slash in preparing a site for planting and shall include scarification and/or slash burning.

"Shorelines of the state" shall have the same meaning as in RCW 90.58.030 (Shoreline Management Act).

"Skid trail" means a route used by tracked or wheeled skidders to move logs to a landing or road.

"Slash" means pieces of woody material containing more than 3 cubic feet resulting from forest practice activities.

"Spoil" means excess material removed as overburden or generated during road or landing construction which is not used within limits of construction.

"Stop work order" means the "stop work order" defined in RCW 76.09.080 of the act and may be issued by the department to stop violations of the forest practices chapter or to prevent damage and/or to correct and/or compensate for damages to public resources resulting from forest practices.

"Threatened or endangered species" ((applies to)) means all species of wildlife listed as "threatened" or "endangered" by the United States ((Fish and Wildlife Service, except any species which the Washington department of wildlife determines does not require special protection under the Forest Practices Act because conservation of the species is reasonably assured through a recovery and enhancement program or existence of an adequate population on lands where commercial forestry and land development are prohibited, or through other means. For this purpose, "wildlife" means all members of the animal kingdom except insects and benthic organisms)) Secretary of the Interior, and all species of wildlife designated as "threatened" or "endangered" by the Washington wildlife commission.

"Timber" shall mean forest trees, standing or down, of a commercial species, including Christmas trees.

"Water bar" means a diversion ditch and/or hump in a trail or road for the purpose of carrying surface water runoff into the vegetation duff, ditch, or other dispersion area so that it does not gain the volume and velocity which causes soil movement and erosion.

"Watershed administrative unit (WAU)" means an area shown on the map specified in WAC 222-22-020(1).

"Watershed analysis" means, for a given WAU, the assessment completed under WAC 222-22-050 or 222-22-060 together with the prescriptions selected under WAC 222-22-070 and shall include assessments completed under WAC 222-22-050 where there are no areas of resource sensitivity.

"Weed" is any plant which tends to overgrow or choke out more desirable vegetation.

"Western Washington" means the lands of the state lying west of the administrative line described in the definition of Eastern Washington.

"Wetland" means those areas that are inundated or saturated by surface or ground water at a frequency and duration sufficient to support, and under normal circumstances do support, a prevalence of vegetation typically adapted for life in saturated soil conditions, such as swamps, bogs, fens, and similar areas. This includes wetlands created, restored, or enhanced as part of a

mitigation procedure. This does not include constructed wetlands or the following surface waters of the state intentionally constructed from wetland sites: Irrigation and drainage ditches, grass lined swales, canals, agricultural detention facilities, farm ponds, and landscape amenities.

"Wetland functions" include the protection of water quality and quantity, providing fish and wildlife habitat, and the production of timber.

"Wetland management zone" means a specified area adjacent to Type A and B Wetlands where specific measures are taken to protect the wetland functions.

"Wildlife" means all species of the animal kingdom whose members exist in Washington in a wild state. The term "wildlife" includes, but is not limited to, any mammal, bird, reptile, amphibian, fish, or invertebrate, at any stage of development. The term "wildlife" does not include feral domestic mammals or the family Muridae of the order Rodentia (old world rats and mice).

"Wildlife reserve trees" means those defective, dead, damaged, or dying trees which provide or have the potential to provide habitat for those wildlife species dependent on standing trees. Wildlife reserve trees are categorized as follows:

Type 1 wildlife reserve trees are defective or deformed live trees that have observably sound tops, limbs, trunks, and roots. They may have part of the top broken out or have evidence of other severe defects that include: "Cat face," animal chewing, old logging wounds, weather injury, insect attack, or lightning strike. Unless approved by the landowner, only green trees with visible cavities, nests, or obvious severe defects capable of supporting cavity dependent species shall be considered as Type 1 wildlife reserve trees. These trees must be stable and pose the least hazard for workers.

Type 2 wildlife reserve trees are dead Type 1 trees with sound tops, limbs, trunks, and roots.

Type 3 wildlife reserve trees are live or dead trees with unstable tops or upper portions. Unless approved by the landowner, only green trees with visible cavities, nests, or obvious severe defects capable of supporting cavity dependent species shall be considered as Type 3 wildlife reserve trees. Although the roots and main portion of the trunk are sound, these reserve trees pose high hazard because of the defect in live or dead wood higher up in the tree.

Type 4 wildlife reserve trees are live or dead trees with unstable trunks or roots, with or without bark. This includes "soft snags" as well as live trees with unstable roots caused by root rot or fire. These trees are unstable and pose a high hazard to workers.

"Windthrow" means a natural process by which trees are uprooted or sustain severe trunk damage by the wind.

AMENDATORY SECTION (Amending Order 535, filed 11/16/87, effective 1/1/88)

WAC 222-16-030 WATER TYPING SYSTEM.  
\*The department in cooperation with the departments of fisheries, wildlife and ecology, and in consultation with affected Indian tribes shall classify streams, lakes and ponds and prepare stream classification maps showing

the location of Type 1, 2, 3 and 4 Waters within the various forested areas of the state. Such maps shall be available for public inspection at ((area)) region offices of the department. The waters will be classified using the following criteria(~~(, except that these agencies may approve classifications of water segments which do not follow the criteria when substantiated evidence demonstrates that use of the criteria would result in incorrect classification of such water according to the definitions contained in WAC 222-16-020. When so requested by any affected landowners, applicant or aggrieved person.))~~). If a dispute arises concerning a water type the department shall make available informal conferences, which shall include the departments of fisheries, wildlife and ecology, and affected Indian tribes and those contesting the adopted water types. These conferences shall be established under procedures established in WAC 222-46-020.

(1) "Type 1 Water" means all waters, within their ordinary high-water mark, as inventoried as "shorelines of the state" under chapter 90.58 RCW and the rules promulgated pursuant to chapter 90.58 RCW, but not including those waters' associated wetlands as defined in chapter 90.58 RCW.

(2) "Type 2 Water" (~~(classification shall be applied to)~~) shall mean segments of natural waters which are not classified as Type 1 Water and have a high fish, wildlife, or human use. These are segments of natural waters and periodically inundated areas of their associated wetlands, which:

(a) Are diverted for domestic use by more than 100 residential or camping units or by a public accommodation facility licensed to serve more than 100 persons, where such diversion is determined by the department to be a valid appropriation of water and the only practical water source for such users. Such waters shall be considered to be Type 2 Water upstream from the point of such diversion for 1,500 feet or until the drainage area is reduced by 50 percent, whichever is less;

(b) Are within a federal, state, local, or private campground having more than 30 camping units: PROVIDED, That the water shall not be considered to enter a campground until it reaches the boundary of the park lands available for public use and comes within 100 feet of a camping unit, trail or other park improvement;

(c) Are used by substantial numbers of anadromous or resident game fish for spawning, rearing or migration. Waters having the following characteristics are presumed to have highly significant fish populations:

(i) Stream segments having a defined channel 20 feet or greater in width between the ordinary high-water marks and having a gradient of less than 4 percent.

(ii) Lakes, ponds, or impoundments having a surface area of 1 acre or greater at seasonal low water.

(d) Are used by salmonids for off-channel habitat. These areas are critical to the maintenance of optimum survival of juvenile salmonids. This habitat shall be identified based on the following criteria:

(i) The site must be connected to a stream bearing salmonids and accessible during some period of the year; and

(ii) The off-channel water must be accessible to juvenile salmonids through a drainage with less than a 5% gradient.

(3) "Type 3 Water" (~~(classifications shall be applied to)~~) shall mean segments of natural waters which are not classified as Type 1 or 2 Water and have a moderate to slight fish, wildlife, and human use. These are segments of natural waters and periodically inundated areas of their associated wetlands which:

(a) Are diverted for domestic use by more than 10 residential or camping units or by a public accommodation facility licensed to serve more than 10 persons, where such diversion is determined by the department to be a valid appropriation of water and the only practical water source for such users. Such waters shall be considered to be Type 3 Water upstream from the point of such diversion for 1,500 feet or until the drainage area is reduced by 50 percent, whichever is less;

(b) Are used by significant numbers of anadromous fish for spawning, rearing or migration. Waters having the following characteristics are presumed to have significant anadromous fish use:

(i) Stream segments having a defined channel of 5 feet or greater in width between the ordinary high-water marks; and having a gradient of less than 12 percent and not upstream of a falls of more than 10 vertical feet.

(ii) Ponds or impoundments having a surface area of less than 1 acre at seasonal low water and having an outlet to an anadromous fish stream.

(c) Are used by significant numbers of resident game fish. Waters with the following characteristics are presumed to have significant resident game fish use:

(i) Stream segments having a defined channel of 10 feet or greater in width between the ordinary high-water marks; and a summer low flow greater than 0.3 cubic feet per second; and a gradient of less than 12 percent.

(ii) Ponds or impoundments having a surface area greater than 0.5 acre at seasonal low water.

(d) Are highly significant for protection of downstream water quality. Tributaries which contribute greater than 20 percent of the flow to a Type 1 or 2 Water are presumed to be significant for 1,500 feet from their confluence with the Type 1 or 2 Water or until their drainage area is less than 50 percent of their drainage area at the point of confluence, whichever is less.

(4) "Type 4 Water" classification shall be applied to segments of natural waters which are not classified as Type 1, 2 or 3, and for the purpose of protecting water quality downstream are classified as Type 4 Water upstream until the channel width becomes less than 2 feet in width between the ordinary high-water marks. Their significance lies in their influence on water quality downstream in Type 1, 2, and 3 Waters. These may be perennial or intermittent.

(5) "Type 5 Water" classification shall be applied to all natural waters not classified as Type 1, 2, 3 or 4; including streams with or without well-defined channels, areas of perennial or intermittent seepage, ponds, natural sinks and drainageways having short periods of spring or storm runoff.

(6) For purposes of this section:

(a) "Residential unit" means a home, apartment, residential condominium unit or mobile home, serving as the principal place of residence.

(b) "Camping unit" means an area intended and used for:

(i) Overnight camping or picnicking by the public containing at least a fireplace, picnic table and access to water and sanitary facilities; or

(ii) A permanent home or condominium unit or mobile home not qualifying as a "residential unit" because of parttime occupancy.

(c) "Resident game fish" means game fish as described in the Washington game code that spend their life cycle in fresh water. Steelhead, searun cutthroat and Dolly Varden trout are anadromous game fish and should not be confused with resident game fish.

(d) "Public accommodation facility" means a business establishment open to and licensed to serve the public, such as a restaurant, tavern, motel or hotel.

(e) "Natural waters" only excludes water conveyance systems which are artificially constructed and actively maintained for irrigation.

(f) "Seasonal low flow" and "seasonal low water" mean the conditions of the 7-day, 2-year low water situation, as measured or estimated by accepted hydrologic techniques recognized by the department.

(g) "Channel width and gradient" means a measurement over a representative section of at least 500 linear feet with at least 10 evenly spaced measurement points along the normal stream channel but excluding unusually wide areas of negligible gradient such as marshy or swampy areas, beaver ponds and impoundments. Channel gradient may be determined utilizing stream profiles plotted from United States geological survey topographic maps.

(h) "Intermittent streams" means those segments of streams that normally go dry.

## NEW SECTION

WAC 222-16-035 WETLAND TYPING SYSTEM. \*The department in cooperation with the departments of fisheries, wildlife, and ecology, and affected Indian tribes shall classify wetlands. The wetlands will be classified in order to distinguish those which require wetland management zones and those which do not. Wetlands which require wetland management zones shall be identified using the following criteria. Accurate delineation of wetlands in accordance with the manual shall be required only where necessary to determine whether replacement by substitution or enhancement is required pursuant to WAC 222-24-025(10) and shall be limited to the area of wetland proposed to be filled. For the purposes of determining acreage to classify or type wetlands under this section, approximate determination using aerial photographs and maps, including the national wetlands inventory, shall be sufficient. In addition, the innermost boundary of the wetland management zone on Type A or B wetlands may be determined by either of two methods: Delineation of the wetland edge, or identifying the point where the crown cover changes from less than 30% to 30% or more. Except where necessary to determine whether replacement by substitution

or enhancement is required pursuant to WAC 222-24-025(10), accurate delineation shall not be required under this Title 222 WAC for activities regulated by these rules, including but not limited to the location of roads, landings, culverts, and cross drains. Landowners are encouraged to leave vegetation in these forested wetlands in undisturbed leave areas where possible. When so requested by any affected landowners, applicant or aggrieved person, the department shall make available informal conferences, which shall include the departments of fisheries, wildlife, and ecology, and affected Indian tribes and those contesting the adopted wetland types. These conferences shall be established under procedures established in WAC 222-46-020.

(1) "Nonforested wetlands" means any wetland or portion thereof that has, or if the trees were mature would have, a crown closure of less than 30 percent.

(a) "Type A Wetland" classification shall be applied to all nonforested wetlands which:

(i) Are greater than 0.5 acre in size, including any acreage of open water where the water is completely surrounded by the wetland; and

(ii) Are associated with at least 0.5 acre of ponded or standing open water. The open water must be present on the site for at least 7 consecutive days between April 1 and October 1 to be considered for the purposes of these rules; or

(iii) Are bogs and fens greater than 0.25 acre.

(b) "Type B Wetland" classification shall be applied to all other nonforested wetlands greater than 0.25 acre.

(2) "Forested wetland" means any wetland or portion thereof that has, or if the trees were mature would have, a crown closure of 30 percent or more.

## AMENDATORY SECTION (Amending WSR 91-23-052, filed 11/15/91, effective 12/16/91)

WAC 222-16-050 CLASSES OF FOREST PRACTICES. There are 4 classes of forest practices created by the act. ~~((These classes are listed below in the order most convenient for the applicant's use in determining into which class his operations fall.))~~ All forest practices (including those in Classes I and II) must be conducted in accordance with the forest practices regulations.

(1) "Class IV - special." Application to conduct forest practices involving the following circumstances requires an environmental checklist in compliance with the State Environmental Policy Act (SEPA), and SEPA guidelines, as they have been determined to have potential for a substantial impact on the environment. It may be determined that additional information or a detailed environmental statement is required before these forest practices may be conducted.

~~\*(a) ((Aerial application of pesticides to an "area of water supply interest" as determined according to WAC 222-38-020 (5)(i)).~~

~~(b) Harvesting, road construction, site preparation or aerial application of pesticides:~~

~~(i) On lands known to contain a breeding pair or the nest or breeding grounds of any threatened or endangered species; or~~

~~(ii) Within the critical habitat designated for such species by the United States Fish and Wildlife Service.~~

~~(c) Widespread use of DDT or a similar persistent insecticide.~~

~~(d)) Aerial application of pesticides in a manner identified as having the potential for a substantial impact on the environment under WAC 222-16-070 or ground application of a pesticide within a Type A or B wetland.~~

~~(b) Specific forest practices listed in WAC 222-16-080 on lands designated as:~~

~~(i) Critical wildlife habitat (state) of threatened or endangered species; or~~

~~(ii) Critical habitat (federal) of threatened or endangered species except those excluded by the board under WAC 222-16-080(3).~~

~~(c) Harvesting, road construction, aerial application of pesticides and site preparation on all lands within the boundaries of any national park, state park, or any park of a local governmental entity, except harvest of less than 5 MBF within any developed park recreation area and park managed salvage of merchantable forest products.~~

~~((e)) (d) Construction of roads, landings, rock quarries, gravel pits, borrow pits, and spoil disposal areas on slide prone areas as defined in WAC 222-24-020(6) and field verified by the department, in a watershed administrative unit that has not undergone a watershed analysis under chapter 222-22 WAC, when such slide prone areas occur on an uninterrupted slope above ((a Type 1, 2, 3 or 4)) water typed pursuant to WAC 222-16-030, Type A or Type B Wetland, or capital improvement of the state or its political subdivisions where there is potential for a substantial debris flow or mass failure to cause significant impact to public resources.~~

~~(e) Timber harvest in a watershed administrative unit that has not undergone a watershed analysis under chapter 222-22 WAC, on slide prone areas, field verified by the department, where soils, geologic structure, and local hydrology indicate that canopy removal has the potential for increasing slope instability, when such areas occur on an uninterrupted slope above any water typed pursuant to WAC 222-16-030, Type A or Type B Wetland, or a capital improvement of the state or its political subdivisions where there is a potential for a substantial debris flow or mass failure to cause significant impact to public resources.~~

~~(f) Timber harvest, in a watershed administrative unit that has not undergone a watershed analysis under chapter 222-22 WAC, construction of roads, landings, rock quarries, gravel pits, borrow pits, and spoil disposal areas on snow avalanche slopes within those areas designated by the department, in consultation with department of transportation, as high avalanche hazard.~~

~~(g) Timber harvest, construction of roads, landings, rock quarries, gravel pits, borrow pits, and spoil disposal areas on archaeological or historic sites registered with the Washington state office of archaeology and historic preservation, or on sites containing evidence of Native American cairns, graves, or glyptic records, as provided for in chapters 27.44 and 27.53 RCW. The department shall consult with affected Indian tribes in identifying such sites.~~

\*(h) Forest practices subject to a watershed analysis conducted under chapter 222-22 WAC in an area of resource sensitivity identified in that analysis which deviates from the prescriptions (which may include an alternate plan) in the watershed analysis.

\* (i) Filling or draining of more than 0.5 acre of a wetland.

(2) "Class IV - general." Applications involving the following circumstances are "Class IV - general" forest practices unless they are listed in "Class IV - special." Upon receipt of an application, the department will determine the lead agency for purposes of compliance with the State Environmental Policy Act pursuant to WAC 197-11-924 and 197-11-938(4) and RCW 43.21C.037(2). Such applications are subject to a 30-day period for approval unless the lead agency determines a detailed statement under RCW 43.21C.030 (2)(c) is required. Upon receipt, if the department determines the application is for a proposal that will require a license from a county/city acting under the powers enumerated in RCW 76.09.240, the department shall notify the applicable county/city under WAC 197-11-924 that the department has determined according to WAC 197-11-938(4) that the county/city is the lead agency for purposes of compliance with State Environmental Policy Act.

(a) Forest practices (other than those in Class I) on lands platted after January 1, 1960, or on lands being converted to another use.

(b) Forest practices which would otherwise be Class III, but which are taking place on lands which are not to be reforested because of likelihood of future conversion to urban development. (See WAC 222-16-060 and 222-34-050.)

(3) "Class I." Those operations that have been determined to have no direct potential for damaging a public resource are Class I forest practices. When the conditions listed in "Class IV - Special" are not present, these operations may be commenced without notification or application.

(a) Culture and harvest of Christmas trees and seedlings.

\* (b) Road maintenance except: (i) Replacement of bridges and culverts across Type 1, 2, 3 or flowing Type 4 Waters; or (ii) movement of material that has a direct potential for entering Type 1, 2, 3 or flowing Type 4 Waters or Type A or B Wetlands.

\* (c) Construction of landings less than 1 acre in size, if not within a shoreline area of a Type 1 Water, the riparian management zone of a Type 2 or 3 Water, ((σ)) the ordinary high-water mark of a Type 4 Water, a wetland management zone or within a wetland.

\* (d) Construction of less than 600 feet of road on a sideslope of 40 percent or less if the limits of construction are not within the shoreline area of a Type 1 Water, the riparian management zone of a Type 2 or Type 3 Water, ((σ)) the ordinary high-water mark of a Type 4 Water, a wetland management zone or within a wetland.

\* (e) Installation or removal of a portable water crossing structure where such installation does not take place within the shoreline area of a Type 1 Water and does

not involve disturbance of the beds or banks of any waters.

\*(f) Initial installation and replacement of relief culverts and other drainage control facilities not requiring a hydraulic permit.

(g) Rocking an existing road.

(h) Loading and hauling timber from landings or decks.

(i) Precommercial thinning and pruning.

(j) Tree planting and seeding.

(k) Cutting and/or removal of less than 5,000 board feet of timber (including live, dead and down material) for personal use (i.e., firewood, fence posts, etc.) in any 12-month period.

(l) Emergency fire control and suppression.

(m) Slash burning pursuant to a burning permit (RCW 76.04.205).

\*(n) Other slash control and site preparation not involving either off-road use of tractors on slopes exceeding 40 percent or off-road use of tractors within the shorelines of a Type 1 Water, the riparian management zone of any Type 2 or 3 Water, or the ordinary high-water mark of a Type 4 Water, a wetland management zone or within a wetland.

\*(o) Ground application of chemicals. (See WAC 222-38-020 and 222-38-030.)

\*(p) Aerial application of chemicals (except insecticides) when applied to not more than 40 contiguous acres if the application is part of a combined or cooperative project with another landowner and where the application does not take place within 100 feet of lands used for farming, or within 200 feet of a residence, unless such farmland or residence is owned by the forest landowner. Provisions of chapter 222-38 WAC shall apply.

(q) Forestry research studies and evaluation tests by an established research organization.

(r) Any of the following if none of the operation or limits of construction takes place within the shoreline area of a Type 1 Water or the riparian management zone of a Type 2 or 3 Water, or within the ordinary high-water mark of a Type 4 Water or flowing Type 5 Water, and the operation does not involve off-road use of tractor or wheeled skidding systems on a sideslope of greater than 40 percent:

(i) Any forest practices within the boundaries of existing golf courses.

(ii) Any forest practices within the boundaries of existing cemeteries which are approved by the cemetery board.

(iii) Any forest practices involving a single landowner where contiguous ownership is less than two acres in size.

(s) Removal of beaver structures from culverts on active and inactive roads. An hydraulics project approval from the Washington department of wildlife or the Washington department of fisheries may be required.

(4) "Class II." Certain forest practices have been determined to have a less than ordinary potential to damage a public resource and may be conducted as Class II forest practices: PROVIDED, That no forest practice enumerated below may be conducted as a Class II forest

practice if the operation requires a hydraulic project approval (RCW 75.20.100) or is within a "shorelines of the state," or involves a bond in lieu of landowners signature (other than renewals). Such forest practices require an application. No forest practice enumerated below may be conducted as a "Class II" forest practice if it takes place on lands platted after January 1, 1960, or on lands being converted to another use. Such forest practices require a Class IV application. Class II forest practices are the following:

(a) Renewal of a prior Class II notification.

(b) Renewal of a previously approved Class III or IV forest practice application where:

(i) No modification of the uncompleted operation is proposed;

(ii) No notices to comply, stop work orders or other enforcement actions are outstanding with respect to the prior application; and

(iii) No change in the nature and extent of the forest practice is required under rules effective at the time of renewal.

\*(c) Any of the following if none of the operation or limits of construction takes place within the riparian management zone of a Type 2 or 3 Water, ((or)) within the ordinary high-water mark of a Type 4 Water, within a wetland management zone or within a wetland:

(i) Construction of advance fire trails.

(ii) Opening a new pit of, or extending an existing pit by, less than 1 acre.

\*(d) Any of the following if none of the operation or limits of construction takes place within the riparian management zone of a Type 2 or 3 Water, ((or)) within the ordinary high-water mark of a Type 4 Water, within a wetland management zone or within a wetland; and if none of the operations involve off-road use of tractor or wheeled skidding systems on a sideslope of greater than 40 percent:

Salvage of logging residue.

\*(e) Any of the following if none of the operation or limits of construction takes place within the riparian management zone of a Type 2 or 3 Water, ((or)) within the ordinary high-water mark of a Type 4 Water, within a wetland management zone or within a wetland and if none of the operations involve off-road use of tractor or wheeled skidding systems on a sideslope of greater than 40 percent, and if none of the operations are located on lands with a likelihood of future conversion (see WAC 222-16-060):

(i) West of the Cascade summit, partial cutting of 40 percent or less of the live timber volume.

(ii) East of the Cascade summit, partial cutting of 5,000 board feet per acre or less.

(iii) Salvage of dead, down, or dying timber if less than 40 percent of the total timber volume is removed in any 12-month period.

(iv) Any harvest on less than 40 acres.

(v) Construction of 600 or more feet of road, provided that the department shall be notified at least 2 business days before commencement of the construction.

(5) "Class III" forest practices not listed under Classes IV, I or II above are "Class III" forest practices. Among Class III forest practices are the following:

(a) Those requiring hydraulic project approval (RCW 75.20.100).

\*(b) Those within the shorelines of the state other than those in a Class I forest practice.

\*(c) Aerial application of insecticides, except where classified as a Class IV forest practice.

\*(d) Aerial application of chemicals (except insecticides), except where classified as Class I or IV forest practices.

\*(e) Harvest or salvage of timber except where classed as Class I, II or IV forest practices.

\*(f) All road construction and reconstruction except as listed in Classes I, II and IV forest practices.

(g) Opening of new pits or extensions of existing pits over 1 acre.

\*(h) Road maintenance involving:

(i) Replacement of bridges or culverts across Type 1, 2, 3, or flowing Type 4 Waters; or

(ii) Movement of material that has a direct potential for entering Type 1, 2, 3 or flowing Type 4 Waters or Type A or B Wetlands.

(i) Operations involving an applicant's bond in lieu of a landowner's signature.

(j) Site preparation or slash abatement not listed in Classes I or IV forest practices.

(k) Harvesting, road construction, site preparation or aerial application of pesticides on lands which contain cultural, historic or archaeological resources which, at the time the application or notification is filed, are:

(i) On or are eligible for listing on the National Register of Historic Places; or

(ii) Have been identified to the department as being of interest to an affected Indian tribe.

(l) Harvesting exceeding 19 acres in a designated difficult regeneration area.

(m) Utilization of an alternate plan. See WAC 222-12-040.

\*(n) Any filling of wetlands, except where classified as Class IV forest practices.

**NEW SECTION**

WAC 222-16-070 PESTICIDE USES WITH THE POTENTIAL FOR A SUBSTANTIAL IMPACT ON THE ENVIRONMENT. \*To identify forest practices involving pesticide uses that have the potential for a substantial impact on the environment, the department shall apply the process prescribed in this section.

(1) Pesticide list - The department shall maintain a list of all pesticides registered under chapter 15.58 RCW for use in forest practices. The department shall conduct, in consultation with the departments of ecology, health, agriculture, and wildlife, an annual review of the list for the purpose of including new pesticides and/or removing those pesticides which have been prohibited from use. The list shall be available to the public at each of the department's offices. A list of the department's offices and their addresses appears at WAC 332-10-030. In preparing the pesticide list, the department shall include information on the following characteristics:

(a) Active ingredients, name brand or trade mark, labeled uses, pesticide type, EPA-registration number;

(b) Toxicity of the pesticide based on the Environmental Protection Agency (EPA) label warning under 40 C.F.R. 156.10 (h)(1), listed as "caution," "warning," "danger," or "danger - poison" except as modified to consider aquatic or mammalian toxicity; and

(c) Whether the pesticide is a state restricted use pesticide for the protection of ground water under WAC 16-228-164(1).

(2) Key for evaluating applications. To determine whether aerial application of a pesticide has the potential for a substantial impact on the environment, the department shall apply the following analysis:

KEY FOR EVALUATION OF SITE SPECIFIC USE OF AERIALY APPLIED CHEMICALS

Question	Question	Resp	Action
1 (a)	Is the pesticide on the pesticide list (WAC 222-16-070(1))?	Yes No	go to 2 go to 1(b)
1 (b)	Is the pesticide being used under a Dept of Agriculture Experimental Use Permit (WAC 16-228-125)?	Yes No	Class III Class IV Sp
2	Is the toxicity rating for the pesticide to be used "Danger -Poison" as designated in the pesticide list (WAC 222-16-070(1)(b))?	Yes No	Class IV Sp go to 3(c)
3 (a)	Is <i>Bacillus thuringiensis</i> (BT) the only pesticide being used on this application?	Yes No	go to 3(b) go to 4(c)
3 (b)	Is there a Threatened or Endangered species or the critical habitat (Federal) or critical wildlife habitat (State) of a species within the application area that is susceptible to the BT strain being used?	Yes No	Class IV Sp Class III
4 (a)	Is this operation occurring over ground water with a high susceptibility to contamination as specified in EPA 910/ 9-87-189 or in documentation provided by the department of ecology?	Yes No	go to 4(b) go to 5(a)
4 (b)	Is this pesticide a state restricted use pesticide for the protection of ground water under WAC 16-228-164 (1)?	Yes No	Class IV Sp go to 5(a)
5 (a)	Is the operation adjacent (within 100 ft.) to surface water?	Yes No	go to 5(b) go to 5(c)
5 (b)	Determine the toxicity rating from the pesticide list: * Is the toxicity rating "Caution" or "Warning"? * Is the toxicity rating "Danger"?	Yes Yes	go to 5(c) go to 5(d)
5 (c)	Is there a Group A or B water surface water system (WAC 246-290-020) intake OR a fish hatchery intake within one half mile downstream of the operation?	Yes No	Class IV Sp go to 5(c)
5 (d)	Is there a Group A or B water surface system intake OR a fish hatchery intake within 1 mile downstream of the operation?	Yes No	Class IV Sp go to 5(c)
5 (e)	Is the operation within 200 feet of the intake of a Group A or B spring water system?	Yes No	Class IV Sp go to 5(f)
5 (f)	Is the operation applying a pesticide in a Type A or B wetland?	Yes No	Class IV Sp go to 6(a)
6 (a)	Does any portion of the planned operation cover 240 or more contiguous acres? Pesticide treatment units will be considered contiguous if they are separated by less than 300 feet or treatment dates of adjacent units are less than 90 days apart.	Yes No	Class IV Sp go to 6(b)
6 (b)	Is there a Threatened or Endangered species or the critical habitat (Federal) or critical wildlife habitat (State) of a species within the application area?	Yes No	Class IV Sp go to 6(c)
6 (c)	If there is a special concern identified for this pesticide in the Board manual, does it apply to this application?	Yes No	Class IV Sp Class III

(3) Special concerns (see WAC 222-16-070 (2)(c)) shall be evaluated by the department of agriculture. Information regarding special concerns shall be presented to the board for review. Approved special concerns shall be included in the board's manual. Special concerns shall include situations where use of pesticides has the potential for a substantial impact on the environment, beyond those covered specifically in the key in subsection (2) of this section.

Reviser's note: The typographical error in the above section occurred in the copy filed by the agency and appears in the Register pursuant to the requirements of RCW 34.08.040.

**NEW SECTION**

WAC 222-16-080 CRITICAL WILDLIFE HABITATS (STATE) AND CRITICAL HABITAT (FEDERAL) OF THREATENED AND ENDANGERED



**SPECIES.** (1) Critical wildlife habitats (state) of threatened or endangered species and specific forest practices designated as Class IV-Special are as follows:

(a) Bald Eagle – harvesting, road construction, aerial application of pesticides, or site preparation within 0.5 mile of a known active nest site, documented by the department of wildlife, between the dates of January 1 and August 15 or 0.25 mile at other times of the year; and within 0.25 mile of a communal roosting site. Communal roosting sites shall not include refuse or garbage dumping sites.

(b) Gray Wolf – harvesting, road construction, or site preparation within 1 mile of a known active den site, documented by the department of wildlife, between the dates of March 15 and July 30 or 0.25 mile from the den site at other times of the year.

(c) Grizzly Bear – harvesting, road construction, aerial application of pesticides, or site preparation within 1 mile of a known active den site, documented by the department of wildlife, between the dates of October 1 and May 30 or 0.25 mile at other times of the year.

(d) Mountain Caribou – harvesting, road construction, aerial application of pesticides, or site preparation within 0.25 mile of a known active breeding area, documented by the department of wildlife.

(e) Oregon silverspot butterfly – harvesting, road construction, aerial or ground application of pesticides, or site preparation within 0.25 mile of an individual occurrence, documented by the department of wildlife.

(f) Peregrine falcon – harvesting, road construction, aerial application of pesticides, or site preparation within 0.5 mile of a known active nest site, documented by the department of wildlife, between the dates of March 1 and July 30; or harvesting, road construction, or aerial application of pesticides within 0.25 mile of the nest site at other times of the year.

(g) Sandhill crane – harvesting, road construction, aerial application of pesticides, or site preparation within 0.25 mile of a known active nesting area, documented by the department of wildlife.

(h) Northern spotted owl – Effective December 1, 1992, harvesting, road construction, or aerial application of pesticides on the 500 acres of suitable nesting, breeding, and foraging habitat surrounding the activity center of known Status 1, 2, or 3 spotted owls, documented by the department of wildlife. Prior to the above effective date, the department shall determine what constitutes critical wildlife habitat (state) for spotted owls in consultation with the department of wildlife. The department's determination shall be limited to harvesting, road construction, or aerial application of pesticides, on lands known to contain the nest or breeding grounds of Status 1, 2, or 3 spotted owls, documented by the department of wildlife.

This rule is intended to be interim and shall be changed as necessary upon completion of the northern spotted owl recovery plan, rule making under the Federal Endangered Species Act, or other federal action, or other state actions.

The department shall rely upon the department of wildlife for the determination of status based on the following definitions:

Status 1 Pair or reproductive – the presence or response of two birds of the opposite sex where past or current reproductive activities have been documented.

Status 2 Two birds, pair status unknown – the presence or response of 2 birds of the opposite sex where pair status cannot be determined and where at least 1 member must meet the resident single requirements.

Status 3 Resident territorial single – the presence or response of a single owl within the same general area on 3 or more occasions within a breeding season with no response by an owl of the opposite sex after a complete survey; or multiple responses over several years (i.e., 2 responses in year one and 1 response in year two, for the same general area).

(i) Western pond turtle – harvesting, road construction, aerial application of pesticides, or site preparation within 0.25 mile of a known individual occurrence, documented by the department of wildlife.

(2) A site specific special wildlife management plan, including a bald eagle site management plan under WAC 232-12-292, developed by the landowner shall replace the critical wildlife habitats (state) listed in subsection (1) of this section when such a plan has been established in cooperation with, and approved by, the department of wildlife.

(3) The following critical habitats (federal) designated by the United States Secretary of the Interior, or specific forest practices within those habitats, have been determined to not have the potential for a substantial impact on the environment:

None listed.

(4) For the purpose of identifying forest practices which have the potential for a substantial impact on the environment with regard to threatened or endangered species newly listed by the Washington wildlife commission and/or the United States Secretary of the Interior, the department shall after consultation with the department of wildlife, prepare and submit to the board a proposed list of critical wildlife habitats (state) of threatened or endangered species. This list shall be submitted to the board within 15 days of the listing of the species. The department shall, at a minimum, consider potential impacts of forest practices on habitats essential to meeting the life requisites for each species listed as threatened or endangered. Those critical wildlife habitats (state) adopted by the board shall be added to the list in subsection (1) of this section. See WAC 222-16-050 (1)(b)(i).

(5) For the purpose of identifying any areas and/or forest practices within critical habitats (federal) designated by the United States Secretary of the Interior which do not have the potential for a substantial impact on the environment, the department shall, after consultation with the department of wildlife, submit to the board a proposed list of any forest practices and/or areas proposed for exclusion from Class IV – special forest practices. The department shall submit the list to the board within 120 days of the date the United States Secretary of the Interior publishes a final rule designating critical habitat (federal) in the Federal Register. Those critical habitats excluded by the board from Class IV – Special shall be added to the list in subsection (3) of this section. See WAC 222-16-050 (1)(b)(ii).

(6)(a) Except for bald eagles under subsection (1)(b) of this section, the critical wildlife habitats (state) of



threatened and endangered species and specific forest practices designated in subsection (1) of this section are intended to be interim. These interim designations shall expire for a given species on the earliest of:

(i) The effective date of a regulatory system for wildlife protection referred to in (b) of this subsection or of substantive rules on the species.

(ii) The delisting of a threatened or endangered species by the Washington wildlife commission.

(b) The board shall examine current wildlife protection and department authority to protect wildlife and develop and recommend by May 1993 a regulatory system, including baseline rules for wildlife protection. To the extent possible, this system shall:

(i) Use the best science and management advice available;

(ii) Use a landscape approach to wildlife protection;

(iii) Be designed to avoid the potential for substantial impact to the environment;

(iv) Protect known populations of threatened and endangered species of wildlife from negative effects of forest practices consistent with RCW 76.09.010; and

(v) Consider and be consistent with recovery plans adopted by the department of wildlife pursuant to RCW 77.12.020(6) or habitat conservation plans or 16 U.S.C. 1533(d) rule changes of the Endangered Species Act.

(7) Regardless of any other provision in this section, the following are not critical wildlife habitats (state) or critical habitats (Federal) for the particular species:

(a) Forest practices on lands covered by a conservation plan and permit for a particular species approved by the U.S. Fish and Wildlife Service pursuant to 16 U.S.C. 1539 (a)(2) consistent with that plan and permit; or

(b) Forest practices covered by a rule adopted by the U.S. Fish and Wildlife Service for the conservation of a particular threatened species pursuant to 16 U.S.C. 1533(d).

#### REPEALER

The following section of the Washington Administrative Code is repealed:

WAC 222-16-020 WATER CATEGORIES.

#### Chapter 222-22 WAC WATERSHED ANALYSIS

#### NEW SECTION

WAC 222-22-010 POLICY. (1) Public resources may be adversely affected by the interaction of two or more forest practices. The purpose of this rule is to address these cumulative effects of forest practices on the public resources of fish, water, and capital improvements of the state or its political subdivisions. The long-term objective of this rule is to protect and restore these public resources and the productive capacity of fish habitat adversely affected by forest practices while maintaining a viable forest products industry. The board intends that this be accomplished through prescriptions designed to protect and allow the recovery of fish, water, and capital improvements of the state or its political subdivisions,

through enforcement against noncompliance of the forest practice rules in this Title 222 WAC, and through voluntary mitigation measures. This system also allows for monitoring, subsequent watershed analysis, and adaptive management.

(2) Adaptive management in a watershed analysis process requires advances in technology and cooperation among resource managers. The board finds that it is appropriate to promulgate rules to address certain cumulative effects by means of the watershed analysis system, while recognizing the pioneering nature of this system and the need to monitor its success in predicting and preventing adverse change to fish, water, and capital improvements of the state and its political subdivisions.

(3) Many factors other than forest practices can have a significant effect on the condition of fish, water, and capital improvements of the state or its political subdivisions. Nonforest practice contributions to cumulative effects should be addressed by the appropriate jurisdictional authorities. When a watershed analysis identifies a potential adverse effect on fish, water, and capital improvements of the state or its political subdivisions from activities that are not regulated under chapter 76.09 RCW, the department should notify any governmental agency or Indian tribe having jurisdiction over those activities.

(4) The rules in this chapter set forth a system for identifying the probability of change and the likelihood of this change adversely affecting specific characteristics of fish, water, and capital improvements of the state or its political subdivisions, and for using forest management prescriptions to avoid or minimize significant adverse effects from forest practices. The rules in this chapter are in addition to, and do not take the place of, the other forest practices rules in this Title 222 WAC.

(5) These rules are intended to be applied and should be construed in such a manner as to minimize the delay associated with the review of individual forest practice applications and notifications by increasing the predictability of the process and the appropriate management response.

#### NEW SECTION

WAC 222-22-020 WATERSHED ADMINISTRATIVE UNITS. (1) For purposes of this chapter, the state is divided into areas known as watershed administrative units (WAUs). The department shall, in cooperation with the departments of ecology, fisheries, and wildlife, federally recognized Indian tribes, local government entities, forest land owners, and the public, define WAUs throughout the state. The department shall identify WAUs on a map.

(2) WAUs should generally be between 10,000 to 50,000 acres in size and should be discrete hydrologic units. The board recognizes, however, that identified watershed processes and potential effects on resource characteristics differ, and require different spatial scales of analysis, and the department's determination of the WAUs should recognize these differences. The board further recognizes that mixed land uses will affect the ability of a watershed analysis to predict probabilities and identify causation as required under this chapter,

and the department's conduct and approval of a watershed analysis under this chapter shall take this effect into account.

(3) The department is directed to conduct periodic reviews of the WAUs adopted under this chapter to determine whether revisions are needed to more efficiently assess potential cumulative effects. The department shall consult the departments of ecology, fisheries, and wildlife, affected Indian tribes, forest land owners, local government entities, and the public. From time to time and as appropriate, the department shall make recommendations to the board regarding revision of watershed administrative units.

#### NEW SECTION

**WAC 222-22-030 QUALIFICATION OF WATERSHED RESOURCE ANALYSTS, SPECIALISTS, AND FIELD MANAGERS.** (1) The department shall set the minimum qualifications for analysts participating in level 1 assessments conducted under WAC 222-22-050, for specialists participating in level 2 assessments conducted under WAC 222-22-060, and for field managers participating in recommendation of prescriptions under WAC 222-22-070. The minimum qualifications shall be specific for the disciplines needed to participate in level 1 and level 2 assessments and in the recommendations of prescriptions, and shall include, at a minimum, formal education in the relevant discipline and field experience. Minimum qualifications for analysts participating in level 2 assessments should typically include a graduate degree in the relevant discipline.

(2) The department shall coordinate with relevant state and federal agencies, affected Indian tribes, forest land owners, local government entities, and the public to seek and utilize available qualified expertise to participate in watershed analysis.

(3) Qualified analysts, specialists, and field managers shall, while and only for the purpose of conducting a watershed analysis or monitoring in a WAU, be duly authorized representatives of the department for the purposes of RCW 76.09.150.

(4) An individual may qualify in more than one science or management skill. Qualification under subsection (1) of this section shall be effective for 5 years. When a qualification expires, a person requesting requalification shall meet the criteria in effect at the time of requalification.

(5) The department shall provide and coordinate training for, maintain a register of, and monitor the performance of qualified analysts, specialists, and field managers by region. The department shall disqualify analysts, specialists, and field managers who fail to meet the levels of performance required by the qualification standards.

#### NEW SECTION

**WAC 222-22-040 WATERSHED PRIORITIZATION.** (1) The department shall determine, by region, the order in which it will analyze WAUs. The department shall cooperate with the departments of ecology, wildlife, and fisheries, affected Indian tribes, forest land

owners, and the public in setting priorities. In setting priorities or reprioritizing WAUs, the department shall consider the availability of participation and assistance that may be provided by affected Indian tribes and local government entities.

(2) Except as set forth in subsection (3) of this section, the department shall undertake a watershed analysis on each WAU, in the order established under subsection (1) of this section.

(3) The owner or owners of ten percent or more of the nonfederal forest land acreage in a WAU may notify the department in writing that the owner or owners intend to conduct a level 1 assessment, level 2 assessment, or both, and the prescription recommendation process on the WAU under this chapter at their own expense. The notice shall identify the teams proposed to conduct the watershed analysis, which shall be comprised of individuals qualified by the department pursuant to WAC 222-22-030. The department shall promptly notify any owner or owners sending notice under this subsection if any member of the designated teams is not so qualified. Within 30 days of delivering a notice to the department under this subsection, the forest land owner or owners shall begin the level 1 assessment under WAC 222-22-050 or, at its option, the level 2 assessment under WAC 222-22-060. An approved forest land owner team shall, while and only for the purposes of conducting a watershed analysis in a WAU, be a duly authorized representative of the department for the purposes of RCW 76.09.150. The board encourages forest land owners conducting assessments under this chapter to include available, qualified expertise from state and federal agencies, affected Indian tribes, forest land owners, local government entities, and the public.

(4) Before beginning an analysis in a WAU, the department or the forest land owner conducting the analysis shall provide reasonable notice, including notice by regular United States mail where names and addresses have been provided to the department, to all forest land owners in the WAU, and to affected Indian tribes. The department or the forest land owner shall provide reasonable notice to the public and to state, federal, and local government entities, by, among other things, posting the notice conspicuously in the office of the departmental region containing the WAU. The notice shall be in a form designated by the department and give notice that an analysis is being conducted, by whose team, the time period of the analysis, and the dates and locations in which the draft analysis will be available for review and comment.

#### NEW SECTION

**WAC 222-22-050 LEVEL 1 WATERSHED RESOURCE ASSESSMENT.** (1) To begin a watershed resource analysis on a WAU, the department shall assemble a level 1 assessment team consisting of analysts qualified under WAC 222-22-030(1). A forest land owner or owners acting under WAC 222-22-040(3) may assemble a level 1 assessment team consisting of analysts qualified under WAC 222-22-030(1) or, at its option, may begin the analysis under WAC 222-22-060. Each level 1 team shall include persons qualified in the

disciplines indicated as necessary in the methodology, and should generally include persons qualified in:

- (a) Forestry;
- (b) Forest hydrology;
- (c) Forest soil science or geology;
- (d) Fisheries science; and
- (e) Geomorphology.

Any owner, and any cooperating group of owners, of ten percent or more of the nonfederal forest land acreage in the WAU and any affected Indian tribe shall be entitled to include one qualified individual to participate on the team at its own expense.

(2) The level 1 team shall perform an inventory of the WAU utilizing the methodology, indices of resource condition, and checklists set forth in the manual in accordance with the following:

(a) The team shall survey the WAU for fish, water, and capital improvements of the state or its political subdivisions and shall display their location on a map of the WAU. The team shall determine the current condition of the resource characteristics of these resources, shall classify their condition as "good," "fair," or "poor," and shall display this information on the map of the WAU. The criteria used to determine current resource conditions shall include indices of resource condition, in addition to such other criteria as may be included in the manual. The indices will include two levels, which will distinguish between good, fair, and poor conditions.

(b) The team shall assess the likelihood that identified watershed processes in a given physical location will be adversely changed by one forest practice or by cumulative effects and that, as a result, a material amount of water, wood, sediment, or energy (e.g., affecting temperature) will be delivered to fish, water, or capital improvements of the state or its political subdivisions. (This process is referred to in this chapter as "adverse change and deliverability.") (For example, the team will address the likelihood that road construction will result in mass wasting and a slide that will in turn reach a stream.) The team shall rate this likelihood of adverse change and deliverability as "high," "medium," "low," or "indeterminate." Those likelihoods rated high, medium, or indeterminate shall be displayed on the map of the WAU.

(c) For each instance of high, medium, or indeterminate likelihood of adverse change and deliverability identified under (b) of this subsection, the team shall assess the vulnerability of potentially affected resource characteristics. Criteria for resource vulnerability shall include indices of resource condition as described in (a) of this subsection and quantitative means to assess the likelihood of material adverse effects to resource characteristics caused by forest practices. (For example, the team will assess the potential damage that increased sediment caused by a slide reaching a stream will cause to salmon spawning habitat that is already in fair or poor condition.) The team shall rate this vulnerability "high," "medium," "low," or "indeterminate" and shall display those vulnerabilities on the map of the WAU. If there are no other criteria in the manual to assess vulnerability at the time of the assessment, current resource

condition shall be used, with good condition equivalent to low vulnerability, fair condition equivalent to medium vulnerability, and poor condition equivalent to high vulnerability.

(d) The team shall identify as areas of resource sensitivity, as provided in table 1 of this section, the locations in which a management response is required under WAC 222-22-070(3) because, as a result of one forest practice or of cumulative effects, there is a combination of a high, medium, or indeterminate likelihood of adverse change and deliverability under (b) of this subsection and a low, medium, high, or indeterminate vulnerability of resource characteristics under (c) of this subsection:

Table 1  
AREAS OF RESOURCE SENSITIVITY AND MANAGEMENT RESPONSE  
Likelihood of Adverse  
Change and Deliverability

		Low	Medium	High
vulnerability	Low	Standard rules	Standard rules	Response: Prevent or avoid
	Medium	Standard rules	Response: Minimize	Response: Prevent or avoid
	High	Standard rules	Response: Prevent or avoid	Response: Prevent or avoid

The team shall display the areas of resource sensitivity on the map of the WAU.

(e) The decision criteria used to determine low, medium, and high likelihood of adverse change and deliverability shall be as set forth in the manual. A low designation generally means there is minimal likelihood that there will be adverse change and deliverability. A medium designation generally means there is a significant likelihood that there will be adverse change and deliverability. A high designation generally means that adverse change and deliverability is more likely than not with a reasonable degree of confidence. Any areas identified as indeterminate in the level 1 assessment shall be classified for the purposes of the level 1 assessment as medium until a level 2 assessment is done on the WAU under WAC 222-22-060, during which the uncertainties shall be resolved.

(f) The team shall prepare a causal mechanism report regarding the relationships of each process identified in (b) and (c) of this subsection. The report shall demonstrate that the team's determinations were made in accordance with the manual. If, in the course of conducting a level 1 assessment, the team identifies areas in which voluntary corrective action will significantly reduce the likelihood of material, adverse effects to the condition of a resource characteristic, the team shall include this information in the report, and the department shall convey this information to the applicable land owner.

(3) Within 21 days of mailing notice under WAC 222-22-040(4), the level 1 team shall submit to the department its draft level 1 assessment, which shall consist of the map of the WAU marked as set forth in this section and the causal mechanism report proposed under

subsection (2)(f) of this section. If the level 1 team is unable to agree as to one or more resource sensitivities or potential resource sensitivities, or the casual mechanism report, alternative designations and an explanation therefor shall be included in the draft assessment. Where the draft level 1 assessment delivered to the department contains alternative designations, the department shall within 21 days of the receipt of the draft level 1 assessment make its best determination and approve that option which it concludes most accurately reflects the proper application of the methodologies, indices of resource condition, and checklists set forth in the manual.

(4) If the level 1 assessment contains any areas in which the likelihood of adverse change and deliverability or resource vulnerability are identified as indeterminate under this section or if the level 1 methodology recommends it, the department shall assemble a level 2 assessment team under WAC 222-22-060 to resolve the uncertainties in the assessment, unless a forest land owner acting under WAC 222-22-040(3) has conducted a level 2 assessment on the WAU.

(5) Pending the completion of the level 2 assessment, if any, on the WAU, the department shall select interim prescriptions using the process and standards described in WAC 222-22-070 (1), (2), and (3) and 222-22-080(3) and shall apply them to applications and notifications as provided in WAC 222-22-090 (1) and (2). Before submitting recommended interim prescriptions to the department, the field managers' team under WAC 222-22-070(1) shall review the recommended prescriptions with available representatives of the jurisdictional management authorities of the fish, water, and capital improvements of the state or its political subdivisions in the WAU, including, but not limited to, the departments of fisheries, ecology, and affected Indian tribes.

#### NEW SECTION

**WAC 222-22-060 LEVEL 2 WATERSHED RESOURCE ASSESSMENT.** (1) The department, or forest land owner acting under WAC 222-22-040(3), may assemble a level 2 assessment team either, in the case of a forest land owner, to begin a watershed analysis or to review the level 1 assessment on a WAU. The level 2 team shall consist of specialists qualified under WAC 222-22-030(1). Each level 2 team shall include persons qualified in the disciplines indicated as necessary in the methodology, and should generally include persons qualified in:

- (a) Forestry;
- (b) Forest hydrology;
- (c) Forest soil science or geology;
- (d) Fisheries science; and
- (e) Geomorphology.

Any owner, and any cooperating group of owners, of ten percent or more of the nonfederal forest land acreage in the WAU and any affected Indian tribe shall be entitled to designate one qualified member of the team at its own expense.

(2) The level 2 team shall perform an assessment of the WAU utilizing the methodology, indices of resource condition, and checklist set forth in the manual in accordance with the following:

(a) If a level 1 assessment has not been conducted under WAC 222-22-050, the assessment team shall complete the tasks required under WAC 222-22-050(2), except that the level 2 team shall not rate any likelihood of adverse change and deliverability or resource vulnerability as indeterminate.

(b) If the level 2 team has been assembled to review a level 1 assessment, the level 2 team shall, notwithstanding its optional review of all or part of the level 1 assessment, review each likelihood of adverse change and deliverability and resource vulnerability rated as indeterminate and shall revise each indeterminate rating to low, medium, or high and shall revise the map of the WAU accordingly.

(3) Within 60 days of mailing notice under WAC 222-22-040(4) where a watershed analysis begins with a level 2 assessment or within 60 days of beginning a level 2 assessment after completion of a level 1 assessment, the level 2 team shall submit to the department its draft level 2 assessment, which shall consist of the map of the WAU and the causal mechanism report.

(4) The level 2 team shall endeavor to produce a consensus report. If the level 2 team is unable to agree as to one or more areas of resource sensitivity or the casual mechanism report, alternative designations and an explanation therefor shall be included in the draft assessment. Where the draft level 2 assessment delivered to the department contains alternative designations or reports, the department shall within 30 days of the receipt of the draft level 2 assessment make its best determination and approve that option which it concludes most accurately reflects the proper application of the methodologies, indices of resource condition, and checklists set forth in the manual.

#### NEW SECTION

**WAC 222-22-070 PRESCRIPTION RECOMMENDATION.** (1) For each WAU for which a watershed analysis is undertaken, the department, or forest land owner acting under WAC 222-22-040(3), shall assemble a team of field managers qualified under WAC 222-22-030(1). The team shall include persons qualified in the disciplines indicated as necessary in the methodology, and shall generally include persons qualified in:

- (a) Forest resource management;
- (b) Forest harvest and road systems engineering;
- (c) Forest hydrology; and
- (d) Fisheries science or management.

Any owner, and any cooperating group of owners, of ten percent or more of the nonfederal forest land acreage in the WAU and any affected Indian tribe shall be entitled to include one qualified individual to participate on the team at its own expense.

(2) Each forest land owner in a WAU shall have the right to submit to the department or the forest land owner conducting the watershed analysis prescriptions for areas of resource sensitivity on its land. If prescriptions are received within the time period described in subsection (4) of this section, they shall be considered for inclusion in the watershed analysis.

(3) For each identified area of resource sensitivity, the field managers' team shall, in consultation with the level

1 and level 2 teams, if any, select and recommend to the department prescriptions. These prescriptions shall be reasonably designed to minimize, or to prevent or avoid, as set forth in table 1 in WAC 222-22-050 (2)(d), the likelihood of adverse change and deliverability that has the potential to cause a material, adverse effect to resource characteristics in accordance with the following:

(a) The prescriptions shall be designed to provide forest land owners and operators with as much flexibility as is reasonably possible while addressing the area of resource sensitivity. The prescriptions should, where appropriate, include, but not be limited to, plans for road abandonment, orphaned roads, and road maintenance and plans for applying prescriptions to recognized land features identified in the WAU as areas of resource sensitivity but not fully mapped;

(b) Each set of prescriptions shall provide for an option for an alternate plan under WAC 222-12-040, which the applicant shows meets or exceeds the protection provided by the other prescriptions approved for a given area of resource sensitivity; and

(c) The regulation of forest practices and cumulative effects under this chapter shall not require mitigation for activities or events not regulated under chapter 76.09 RCW. Any hazardous condition subject to forest practices identified in a watershed analysis requiring corrective action shall be referred to the department for consideration under RCW 76.09.300 et seq.

(4) The field managers' team shall submit the recommended prescriptions to the department within 30 days of the submission to the department of the level 2 assessment under WAC 222-22-060 or within 21 days of the submission to the department of the level 1 assessment under WAC 222-22-050.

#### NEW SECTION

**WAC 222-22-080 APPROVAL OF WATERSHED ANALYSIS.** (1) Upon receipt of the recommended prescriptions resulting from a level 2 assessment under WAC 222-22-060 or a level 1 assessment under WAC 222-22-050 where a level 2 assessment will not be conducted, the department shall select prescriptions. The department shall circulate the draft watershed analysis to the departments of ecology, fisheries, and wildlife, affected Indian tribes, local government entities, forest land owners in the WAU, and the public for review and comment. The prescriptions recommended by the field managers' team shall be given substantial weight. Within thirty days of receipt of the prescriptions, the department shall review comments, revise the watershed analysis as appropriate, and approve or disapprove the watershed analysis for the WAU.

(2) The department should notify any governmental agency or Indian tribe having jurisdiction over activities which are not regulated under chapter 76.09 RCW but which are identified in the draft analysis as having a potential for an adverse impact on identified fish, water, and capital improvements of the state or its political subdivisions.

(3) The department shall approve the draft watershed analysis unless it finds:

(a) For any level 1 assessment or level 2 assessment, that:

(i) The team failed in a material respect to apply the methodology, indices of resource condition, or checklists set forth in the manual; or

(ii) A team meeting the criteria promulgated by the department and using the defined methodologies, indices of resource conditions, and checklists set forth in the manual could not reasonably have come to the conclusions identified in the draft level 1 or level 2 assessment; and

(b) For the prescriptions, that they will not accomplish the purposes and policies of this chapter and of the Forest Practices Act, chapter 76.09 RCW.

(c) In making its findings under this subsection, the department shall take into account its ability to revise assessments under WAC 222-22-090(3).

(4) If the department does not approve the draft watershed analysis, it shall set forth in writing a detailed explanation of the reasons for its disapproval.

#### NEW SECTION

**WAC 222-22-090 USE AND REVIEW OF WATERSHED ANALYSIS.** (1) Where a watershed analysis has been completed for a WAU under this chapter:

(a) Forest practices applications and notifications submitted to the department shall indicate whether an area of resource sensitivity will be affected and, if so, which prescription the operator, timber owner, or forest land owner shall use in conducting the forest practice in the area of resource sensitivity;

(b) The department shall assist operators, timber owners, and forest land owners in obtaining governmental permits required for the prescription (see WAC 222-50-020 and 222-50-030);

(c) The department shall confirm that the prescription selected under (a) of this subsection was one of the prescriptions approved for the area of resource sensitivity under WAC 222-22-080 and shall require the use of the prescription; and

(d) The department shall not further condition forest practice applications and notifications in an area of resource sensitivity in a WAU where the applicant will use a prescription contained in the watershed analysis nor shall the department further condition forest practice applications and notifications outside an area of resource sensitivity in a WAU, except for reasons other than the watershed processes and fish, water, and capital improvements of the state or its political subdivisions analyzed in the watershed analysis in the WAU, and except to correct mapping errors, misidentification of soils, landforms, vegetation, or stream features, or other similar factual errors.

(2) Pending completion of a watershed analysis for a WAU, the department shall process forest practices notifications and applications in accordance with the other chapters of this title, except that applications and notifications received for forest practices on a WAU after the date notice is mailed under WAC 222-22-040(4) commencing a watershed analysis on the WAU shall be conditioned to require compliance with interim, draft,

and final prescriptions, as available. Processing and approval of applications and notifications shall not be delayed by reason of review, approval, or appeal of a watershed analysis.

(3) The board encourages cooperative and voluntary monitoring. Evaluation of resource conditions may be conducted by qualified specialists, analysts, and field managers as determined under WAC 222-22-030. Subsequent watershed analysis and management strategies in response to areas where recovery is not occurring shall be conducted in accordance with this chapter.

(4) Where the condition of resource characteristics in a WAU are fair or poor, the department shall evaluate the effectiveness of the prescriptions applied under this chapter to the WAU in providing for the protection and recovery of the resource characteristic. If the department finds that the prescriptions are not providing for such protection and recovery over a period of 3 years, the department shall repeat the watershed analysis in the WAU. Aside from the foregoing, once a watershed analysis is completed on a WAU, it shall be revised in whole or in part upon the earliest of the following to occur:

(a) Five years after the date the watershed analysis is final, if necessary;

(b) The occurrence of a natural disaster having a material adverse effect on the resource characteristics of the WAU;

(c) Deterioration in the condition of a resource characteristic in the WAU measured over a 12-month period or no improvement in a resource characteristic in fair or poor condition in the WAU measured over a 12-month period unless the department determines, in cooperation with the departments of ecology, wildlife, and fisheries, affected Indian tribes, forest land owners, and the public, that a longer period is reasonably necessary to allow the prescriptions selected to produce improvement; or

(d) The request of an owner of forest land in the WAU which wishes to conduct a watershed analysis at its own expense.

Revision of an approved watershed analysis shall be conducted in accordance with the processes, methods, and standards set forth in this chapter, except that the revised watershed analysis shall be conducted only on the areas affected in the case of revisions under (b) or (c) of this subsection, and may be conducted on areas smaller than the entire WAU in the case of revisions under (a) and (d) of this subsection. The areas on which the watershed analysis revision is to be conducted shall be determined by the department and clearly delineated on a map before beginning the assessment revision. Forest practices shall be conditioned under the current watershed analysis pending the completion of any revisions.

#### NEW SECTION

WAC 222-22-100 APPLICATION REVIEW PRIOR TO WATERSHED ANALYSIS. The watershed analysis system established in this chapter is a principal methodology for assessing the effects on fish, water, and capital improvements of the state or its political subdivisions of two or more forest practices. Recognizing that it will not be possible to achieve state-wide

implementation of the analysis process for all WAUs for some time, the board hereby establishes certain interim regulatory measures pending watershed analysis on a given WAU. These measures are designed to ensure use of the best available analysis techniques and existing authorities to protect fish, water, and capital improvements of the state or its political subdivisions.

(1) The department shall continue to use its implementation and enforcement authority to prevent damage to fish, water, and capital improvements of the state or its political subdivisions. See chapter 222-46 WAC.

(a) The department shall continue to concentrate and exercise its authority in implementing the use of existing road construction, maintenance, and abandonment rules where there is evidence of road-related damage to fish, water, and capital improvements of the state or its political subdivisions. The applicable road construction and maintenance rules can be found in chapter 222-24 WAC.

(b) The department shall report to the board each quarter the results of its road construction, maintenance, and abandonment enforcement program. No later than October 31 of each year, the board shall report on results and recommendations for regulatory change as needed to protect fish, water, and capital improvements of the state or its political subdivisions.

(2) The department shall condition the size of clearcut harvest applications in the significant rain-on-snow zone where the department determines, using local evidence, that peak flows have resulted in material damages to public resources. The department may prepare conditioning guidelines to assess and condition applications located in a significant rain-on-snow zone.

(a) Each year not later than August 31, the department shall provide a summary report of actions taken under rain-on-snow conditioning or conditioning guidelines to the appropriate board committee.

(b) Such conditioning authority shall expire upon completion of watershed analysis in a WAU.

(c) Nothing in this section shall require a watershed analysis to develop harvest size recommendations.

AMENDATORY SECTION (Amending Order 535, filed 11/16/87, effective 1/1/88)

\* WAC 222-24-010 POLICY. ((\*)(1)) (1) A well designed, located, constructed, and maintained system of forest roads is essential to forest management and protection of the public resources. Riparian areas contain some of the more productive conditions for growing timber, are heavily used by wildlife and provide essential habitat for fish and wildlife and essential functions in the protection of water quality. Wetland areas serve several significant functions in addition to timber production: Providing fish and wildlife habitat, protecting water quality, moderating and preserving water quantity. Wetlands may also contain unique or rare ecological systems.

(2) All road and landing construction within wetlands shall be conducted so that choices are made in the following descending order of preference:

(a) Avoid impacts by selecting the least environmentally damaging landing location, road location and road length; or

(b) Minimize impacts by such things as reducing the subgrade width, fill acreage and spoil areas; or

(c) Restore affected areas by removing temporary fills or road sections upon the completion of the project; or

(d) Reduce or eliminate impacts over time by preserving or maintaining areas; or

(e) Replace affected areas by creating new wetlands or enhancing existing wetlands.

(3) An accurate delineation of wetland boundaries shall not be required under this section except where necessary to determine acreage of road or landing construction which fills or drains more than 0.5 acre of a wetland. Landowners are encouraged to voluntarily increase wetland acreage and functions over the long-term.

(4) Extra protection is required during road construction and maintenance to protect ~~((this habitat))~~ these resources and timber growing potential. Landowners and fisheries and wildlife managers are encouraged to cooperate to develop road management and abandonment plans. Landowners are further encouraged to cooperate in sharing roads to minimize road mileage and avoid duplicative road construction.

(5) This section covers the location, design, construction, maintenance and abandonment of forest roads, bridges, stream crossings, quarries, borrow pits, and disposal sites used for forest road construction and is intended to assist landowners in proper road planning, construction and maintenance so as to protect public resources.

(Note: Other laws and regulations and/or permit requirements may apply. See chapter 222-50 WAC.)

#### AMENDATORY SECTION (Amending Order 535, filed 11/16/87, effective 1/1/88)

WAC 222-24-020 ROAD LOCATION. (1) Fit the road to the topography so that a minimum of alterations to the natural features will occur.

\*~~(2) Minimize roads along or within narrow canyons ((and along)), riparian management zones, ((wet meadows and marshes)) wetlands and wetland management zones.~~

(a) Except where crossings are necessary, roads shall not be located within natural drainage channels and riparian management zones when there would be substantial loss or damage to wildlife habitat unless ~~((adequate mitigation of damage to public resources is provided and))~~ the department has determined that alternatives will cause greater damage to public resources.

(b) Roads shall not be located in ~~((marshes or wet meadows)) wetlands~~ when there would be substantial loss or damage to ~~((wildlife habitat)) wetland functions or acreage unless ~~((adequate mitigation of damage to public resources is provided and))~~ the department has determined that alternatives will cause greater damage to public resources.~~

(c) Approximate determination of wetland boundaries shall be required for the purpose of avoidance during

design and construction of roads. Landowners should attempt to minimize road length concurrently with the attempt to avoid wetlands. Delineation shall be required to determine the length of road constructed within a wetland in order to determine acreage when replacement by substitution or enhancement of a wetland is required. The requirement for accurate delineation shall be limited to the area of the wetland proposed to be filled.

\*~~(3) Minimize the number of stream crossings.~~

\*~~(4) Whenever practical, cross streams at right angles to the main channel.~~

(5) Avoid duplicative roads by keeping the total amount of construction to a minimum. Use existing roads whenever practical and avoid isolating patches of timber which, when removed, may require unnecessary road construction.

\*~~(6) Where feasible, do not locate roads on excessively steep or unstable slopes or known slide prone areas as determined by the department. The department shall determine whether slopes are unstable using available soils information, or from evidence of geologically recent slumps or slides, or where the natural slope exceeds the angle of repose for the particular soil types present, or where springs or seeps may indicate unstable conditions are present in or above the construction site.~~

Essential road construction will be accomplished by end hauling, over hauling, or other special road construction techniques unless the department determines there is potential for damage to public resources under WAC 222-16-050 (1)(e).

#### AMENDATORY SECTION (Amending Order 535, filed 11/16/87, effective 1/1/88)

WAC 222-24-025 ROAD DESIGN. (1) Use the minimum design standard that produces a road sufficient to carry the anticipated traffic load with reasonable safety.

\*~~(2) Subgrade width should average not more than 32 feet for double lane roads and 20 feet for single lane roads, exclusive of ditches, plus any additional width necessary for safe operations on curves and turnouts. Where road location in wetlands is unavoidable (see WAC 222-24-010(2)), minimize subgrade width.~~

(3) Balance excavation and embankments so that as much of the excavated material as is practical will be deposited in the roadway fill sections. Where full bench construction is necessary, design suitable embankments so that the excavated material may be end hauled to appropriate deposit areas.

(4) Design or construct cut and fill slopes to the normal angle of repose for the materials involved, or at a lesser angle whenever practical.

\*~~(5) All roads should be outslopped or ditched on the uphill side and appropriate surface drainage shall be provided by the use of adequate cross drains, ditches, drivable dips, relief culverts, water bars, diversion ditches, or other such structures demonstrated to be equally effective.~~

\*~~(6) Cross drains, relief culverts, and diversion ditches shall not discharge onto erodible soils, or over fill slopes unless adequate outfall protection is provided.~~



\* (7) Install cross drains, culverts, water bars, drivable dips, or diversion ditches on all forest roads to minimize erosion of the road bed, cut bank, and fill slope, or to reduce sedimentation of Type 1, 2, 3 or 4 Water. Cross drains are required in wetlands to provide for continued hydrologic connectivity. These drainage structures shall be installed at all natural drainages, all low points in the road gradient and spaced no wider than as follows:

Grade	Distance Westside	Distance Eastside
0 to 7%	1,000 ft.	1,500 ft.
8% to 15%	800 ft.	1,000 ft.
over 15%	600 ft.	800 ft.

More frequent culvert spacing or other drainage improvements are required where site specific evidence of peak flows or soil instability makes additional culverts necessary to minimize erosion of the road bed, ditches, cut bank, and fill slope to reduce sedimentation of Type 1, 2, 3 or 4 Waters, or within wetlands or to avoid unreasonable risk to public resources. See Part 5, Table 2 in the forest practices board manual for "Additional culvert spacing recommendations." On request of the applicant, the department may approve less frequent drainage spacing where parent material (e.g. rock, gravel) or topography justify.

\* (8) Relief culverts installed on forest roads shall meet the following minimum specifications:

(a) Be at least ((+2)) 18 inches in diameter or equivalent in western Washington and 15 inches in diameter or equivalent in eastern Washington.

(b) Be installed sloping toward the outside edge of the road at a minimum gradient of 3 percent.

\* (9) Ditch diversion. Where roadside ditches slope toward a Type 1, 2, ((or)) 3 Water, or Type A or B Wetland for more than 300 feet and otherwise would discharge into the stream or wetland, divert the ditchwater onto the forest floor by relief culvert or other means at the first practical point.

\* (10) Filling or draining more than 0.5 acre of a wetland requires replacement by substitution or enhancement of the lost wetland functions and, for creation of new wetlands, area. See the Board Manual. Where creation of new wetlands is proposed, the objective of successful replacement by substitution of lost wetland area shall be on an acre for acre basis and of the same type and in the same general location. Where replacement by enhancement of wetlands is proposed, the objective shall be to provide for an equivalent amount of function to replace that which is lost.

**AMENDATORY SECTION (Amending Order 535, filed 11/16/87, effective 1/1/88)**

WAC 222-24-030 ROAD CONSTRUCTION. (1) Right of way timber. Merchantable right of way timber shall be removed or decked in suitable locations where the decks will not be covered by fill material or act as support for the fill or embankment.

\* (2) Debris burial.

(a) In permanent road construction, do not bury:

(i) Loose stumps, logs or chunks containing more than 5 cubic feet in the load-bearing portion of the road, except as puncheon across ((swampy ground)) wetlands or for culvert protection.

(ii) Any significant amount of organic debris within the top 2 feet of the load-bearing portion of the road, except as puncheon across ((swampy ground)) wetlands or for culvert protection.

(iii) Excessive accumulation of debris or slash in any part of the load-bearing portion of the road fill, except as puncheon across swampy ground or for culvert protection.

(b) In the cases where temporary roads are being constructed across known areas of unstable soils and where possible construction failure would directly impact waters, the requirements in (a), (i), (ii) and (iii) of this subsection shall apply. A temporary road is a roadway which has been opened for the purpose of the forest practice operation in question, and thereafter will be an inactive or abandoned road.

(3) Compact fills. During road construction, fills or embankments shall be built up by layering. Each layer shall be compacted by operating the tractor or other construction equipment over the entire surface of the layer. Chemical compacting agents may be used in accordance with WAC 222-38-020.

\* (4) Stabilize soils. When soil, exposed by road construction, appears to be unstable or erodible and is so located that slides, slips, slumps, or sediment may reasonably be expected to enter Type 1, 2, 3 or 4 Water and thereby cause damage to a public resource, then such exposed soil areas shall be seeded with grass, clover, or other ground cover, or be treated by erosion control measures acceptable to the department. Avoid introduction of nonnative plant species, as listed in the board manual, to wetlands and wetland management zones.

\* (5) Channel clearance. Clear stream channel of all debris and slash generated during operations prior to the removal of equipment from the vicinity, or the winter season, whichever is first.

\* (6) Drainage.

(a) All required ditches, culverts, cross drains, drainage dips, water bars, and diversion ditches shall be installed concurrently with the construction of the roadway.

(b) Uncompleted road construction to be left over the winter season or other extended periods of time shall be drained by outsliping or cross draining. Water bars and/or dispersion ditches may also be used to minimize eroding of the construction area and stream siltation. Water movement within wetlands must be maintained.

\* (7) Moisture conditions. Construction shall be accomplished when moisture and soil conditions are not likely to result in excessive erosion and/or soil movement, so as to avoid damage to public resources.

\* (8) End haul/sidecasts. End haul or overhaul construction is required where significant amounts of sidecast material would rest below the 50-year flood level of a Type 1, 2, 3, or 4 Water, within the boundary of a Type A or Type B Wetland or wetland management

zones or where the department determines there is a potential for mass soil failure from overloading on unstable slopes or from erosion of side cast material causing damage to the public resources.

**\*(9) Waste disposal.** When spoil, waste and/or other debris is generated during construction, this material shall be deposited or wasted in suitable areas or locations and be governed by the following:

(a) Spoil or other debris shall be deposited above the 50-year flood level of Type 1, 2, 3, or 4 Waters or in other locations so as to prevent damage to public resources. The material shall be stabilized by erosion control measures as necessary to prevent the material from entering the waters.

(b) All spoils shall be located outside of Type A and Type B Wetlands and their wetland management zones. Spoils shall not be located within the boundaries of forested wetlands without written approval of the department and unless a less environmentally damaging location is unavailable. No spoil area greater than 0.5 acre in size shall be allowed within wetlands.

**AMENDATORY SECTION** (Amending Order 535, filed 11/16/87, effective 1/1/88)

**WAC 222-24-035 LANDING LOCATION AND CONSTRUCTION.** **\*(1) Landing location:**

Locate landings to prevent damage to public resources. Avoid excessive excavation and filling. Minimize placement and size of landings within wetlands. Landings shall not be located in Type A or B Wetlands or their wetland management zones.

(2) Landing construction.

(a) Landings requiring sidecast or fill shall be no larger than reasonably necessary for safe operation of the equipment expected to be used.

(b) Where the average general slopes exceed 65 percent, fill material used in construction of landings shall be free from loose stumps and excessive accumulations of slash and shall be mechanically compacted where necessary and practical in layers by tractor to prevent soil erosion and mass soil movement. Chemical compacting agents may be used in accordance with WAC 222-38-020.

**\*(c) Truck roads, skid trails, and fire trails shall be outsloped or cross drained uphill of landings and the water diverted onto the forest floor away from the toe of any landing fill.**

**\*(d) Landings shall be sloped to minimize accumulation of water on the landing.**

**\*(e) Excavation material shall not be sidecast where there is high potential for material to enter Type A or B Wetlands or wetland management zones or below the ordinary high-water mark of any stream or the 50-year flood level of Type 1, 2, 3, or 4 Water.**

**\*(f) All spoils shall be located outside of Type A and Type B Wetlands and their wetland management zones. Spoils shall not be located within the boundaries of forested wetlands without written approval of the department and unless a less environmentally damaging location is unavailable. No spoil area greater than 0.5 acre in size shall be allowed within wetlands.**

**AMENDATORY SECTION** (Amending Order 535, filed 11/16/87, effective 1/1/88)

**WAC 222-24-040 WATER CROSSING STRUCTURES.** **\*(1) Bridge construction.**

(a) Bridges are required for new crossings of any Type 1 or 2 Waters regularly used for recreational boating.

(b) Permanent bridges shall not constrict clearly defined channels and shall be designed to pass the 50-year flood level or the road shall be constructed to provide erosion protection from the 50-year flood waters which exceed the water-carrying capacity of the drainage structure.

(c) One end of each new permanent log or wood bridge shall be tied or firmly anchored if any of the bridge structure is within 10 vertical feet of the 50-year flood level.

(d) Excavation for bridges, placement of sills or abutments, and the placement of stringers or girders shall be accomplished from outside the ordinary high-water mark of all waters, except when such operations are authorized by a hydraulic project approval.

(e) Earth embankments constructed for use as bridge approaches shall be protected from erosion by high water. Some examples of protection are: Planted or seeded ground cover, bulkheads, rock riprap, or retaining walls.

(f) When earthen materials are used for bridge surfacing, curbs of sufficient size shall be installed to be above the surface material and prevent such surface material from falling into the stream bed.

**\*(2) Culvert installation:** All permanent culverts installed in forest roads shall be of a size that is adequate to carry the 50-year flood or the road shall be constructed to provide erosion protection from the 50-year flood waters which exceed the water-carrying capacity of the drainage structure. Refer to Part 5 "Recommended culvert sizes" in the forest practices board manual for the size of permanent culverts recommended for use in forest roads. If the department determines that because of unstable slopes the culvert size shown on that table is inadequate to protect public resources, it may require culvert sizes in accordance with the nomograph (chart) contained in Part 5 of the forest practices board manual or with other generally accepted engineering principles.

(a) No permanent culverts shall be installed that are smaller than:

(i) 24 inches in diameter or the equivalent for anadromous fish streams or wetlands where anadromous fish are present.

(ii) 18 inches or the equivalent for ~~((the resident game fish streams:~~

~~(iii) 12 inches or the equivalent for))~~ all other water or wetland crossings in western Washington.

(iii) 15 inches or the equivalent for all other water or wetland crossings in eastern Washington.

(b) The alignment and slope of the culvert shall parallel the natural flow of the stream whenever possible.

(c) When fish life is present, construct the bottom of the culvert at or below the natural stream bed at the inlet and outlet.

(d) Terminate culverts on materials that will not readily erode, such as riprap, the original stream bed (if stable), or other suitable materials.

(e) If water is diverted from its natural channel, return this water to its natural stream bed via culvert, flume, spillway, or the equivalent.

(f) When flumes, downspouts, downfall culverts, etc., are used to protect fill slopes or to return water to its natural courses, the discharge point shall be protected from erosion by: (i) Reducing the velocity of the water, (ii) use of rock spillways, (iii) riprap, (iv) splash plates, or (v) other methods or structures demonstrated to be equally effective.

(g) Stream beds shall be cleared for a distance of 50 feet upstream from the culvert inlet of such slash or debris that reasonably may be expected to plug the culvert.

(h) The entrance of all culverts should have adequate catch basins and headwalls to minimize the possibility of erosion or fill failure.

\* (3) Culverts in anadromous fish streams. In addition to the requirements of subsection (2) of this section, in streams used by anadromous fish:

(a) Culverts shall be either open bottomed or have the bottom covered with gravel and installed at least 6 inches below the natural stream bed at the inlet and outlet.

(b) Closed bottom culverts shall not slope more than 1/2 percent; except as provided in (e) of this subsection; open bottom culverts shall not slope more than the natural slope of the stream bed.

(c) Where multiple culverts are used, one culvert shall be at least 6 inches lower than the other(s).

(d) Culverts shall be set to retain normal stream water depth throughout the culvert length. A downstream control may be required to create pooled water back into the culvert and to insure downstream stream bed stability.

(e) Closed bottom culverts, set at existing stream gradients between 1/2 percent and 3 percent slope shall be designed with baffles for water velocity control, or have an approved designed fishway.

(f) The department, after consultation with the departments of fisheries and wildlife, shall impose any necessary limitations on the time of year in which such culverts may be installed to prevent interference with migration or spawning of anadromous fish.

(g) Any of the requirements in (a) through (f) of this subsection may be superseded by a hydraulic project approval.

\* (4) Temporary water crossings.

(a) Temporary bridges and culverts, adequate to carry the highest anticipated flow in lieu of carrying the 50-year flood, may be used:

(i) In the westside region if installed after June 1 and removed by September 30 of the same year.

(ii) In the eastside region if installed after the spring runoff and removed prior to the snow buildup which could feed a heavy runoff.

(iii) At other times, when the department and applicant can agree to specific dates of installation and removal.

(b) Temporary bridges and culverts shall be promptly removed upon completion of use, and the approaches to

the crossing shall be water barred and stabilized at the time of the crossing removal.

(c) Temporary wetland crossings shall be abandoned and restored based on a written plan approved by the department prior to construction.

(5) Properly prepared and maintained fords may be used during periods of low water providing a hydraulic permit is acquired.

AMENDATORY SECTION (Amending Order 535, filed 11/16/87, effective 1/1/88)

WAC 222-24-050 ROAD MAINTENANCE. \*(1) Road maintenance and abandonment plan.

(a) The landowner when notified by the department shall submit a plan for road maintenance and abandonment for those drainages or road systems the department determines based on physical evidence to have a potential to damage public resources. The plan is subject to annual review and shall include:

(i) Ownership maps showing the road or road system;  
 (ii) Road status, whether active, inactive, abandoned or planned for abandonment;  
 (iii) Maintenance schedule and priorities for the year; and

(iv) Plan for further maintenance and reconstruction beyond the current year for repair of extensive damage.

(b) The plan shall be submitted to the department region office on or before June 30, 1988, and each June 30th thereafter unless the department agrees that no further plans are necessary.

(c) The department will review the plan annually with the landowner to determine whether it will be effective and is being implemented.

(d) Such plans shall also be reviewed with departments of ecology, fisheries and wildlife and affected Indian tribes, any of whom may request an informal conference with the landowner.

\* (2) Active roads. An active road is a forest road being actively used for hauling of logs, pulpwood, chips, or other major forest products or rock and other road building materials. To the extent necessary to prevent damage to public resources, the following maintenance shall be conducted on such roads:

(a) Culverts and ditches shall be kept functional.  
 (b) Road surface shall be maintained as necessary to minimize erosion of the surface and the subgrade.

(c) During and on completion of operations, road surface shall be crowned, outsloped, or water barred and berms removed from the outside edge except those intentionally constructed for protection of fills.

\* (3) Inactive roads. An inactive road is a forest road on which commercial hauling is discontinued for 1 or more logging seasons, and the forest landowner desires continuation of access for fire control, forest management activities, Christmas tree growing operations, occasional or incidental use for minor forest products harvesting or similar activities on such inactive roads:

(a) Before the first winter rainy season following termination of active use, nonfunctional ditches and culverts shall be cleared and the road surface shall be crowned, outsloped, water barred or otherwise left in a

condition not conducive to accelerated erosion or inter-rupt water movement within wetlands; and

(b) Thereafter, except as provided in (c) of this subsection, the landowner shall clear or repair ditches or culverts which he knows or should know to be nonfunctional and causing or likely to cause material damage to a public resource.

(c) The landowner shall not be liable for penalties or monetary damages, under the act, for damage occurring from a condition brought about by public use, unless he fails to make repairs as directed by a notice to comply.

\* (4) Additional culverts/maintenance. If the department determines based on physical evidence that the above maintenance has been or will be inadequate to protect public resources and that additional measures will provide adequate protection it shall require the landowner or operator to either elect to:

(a) Install additional or larger culverts or other drainage improvements as deemed necessary by the department; or

(b) Agree to an additional road maintenance program. Such improvements in drainage or maintenance may be required only after a field inspection and opportunity for an informal conference.

\* (5) Abandoned roads. An abandoned road is a forest road which the forest landowner has abandoned in accordance with procedures of (a) through (e) of this subsection. Roads are exempt from maintenance only after (e) of this subsection is completed:

(a) Roads are outsloned, water barred, or otherwise left in a condition suitable to control erosion and maintain water movement within wetlands; and

(b) Ditches are left in a suitable condition to reduce erosion; and

(c) The road is blocked so that four wheel highway vehicles can not pass the point of closure at the time of abandonment; and

(d) Bridges, culverts, and fills on all waters are removed, except where the department determines other measures would provide adequate protection to public resources.

(e) The department shall determine whether the road has been abandoned according to procedures of this subsection. If the department determines the road is properly abandoned, it shall within thirty days notify the landowner in writing that the road is officially abandoned.

\* (6) Brush control. Chemical control of roadside brush shall not be done where chemicals will directly enter any Type 1, 2, or 3 or flowing Type 4 or 5 Water or Type A or B Wetlands. Refer to WAC 222-38-020 for additional information.

\* (7) Road surface treatment.

(a) Apply oil to the road surface only when the temperature is above 55 degrees F and during the season when there is a minimal chance of rain for the next 48 hours. Use of waste oil is subject to RCW 70.951.060(5).

(b) Water the road surface prior to application of oil to assist in penetration.

(c) Construct a temporary berm along the road shoulder wherever needed to control runoff of the applied chemical.

(d) Take extreme care to avoid excess application of road chemicals. Shut off the flow at all bridges.

(e) When cleaning out chemical storage tanks or the application equipment tanks used for storage and application of road treatment materials, dispose of the rinse water fluids on the road surface or in a place safe from potential contamination of water.

(f) The use of dry road chemicals shall be in compliance with WAC 222-38-020.

#### AMENDATORY SECTION (Amending Order 535, filed 11/16/87, effective 1/1/88)

WAC 222-24-060 ROCK QUARRIES, GRAVEL PITS, BORROW PITS, AND SPOIL DISPOSAL AREAS. Not covered by the Surface Mine Reclamation Act of 1971 (chapter 78.44 RCW).

\* (1) Location of pits. Except as approved by the department, rock quarries and gravel pits opened after January 1, 1975 shall be located above the 50-year flood level.

\* (2) Location of spoil disposal areas. Except as approved by the department, spoil disposal areas shall be located:

(a) Above the 50-year flood level.

(b) Where the final slope after disposal will be no steeper than 1 1/2:1.

(c) Where practical, on areas having low potential timber productivity.

(d) Where the risk of soil erosion and mass soil movement is minimal.

(e) All spoils shall be placed to allow drainage without additional water ponding.

(f) All spoils shall be located outside of Type A and Type B Wetlands and their wetland management zones. Spoils shall not be located within the boundaries of forested wetlands without written approval of the department and unless a less environmentally damaging location is unavailable. No spoil area greater than 0.5 acre in size shall be allowed within wetlands.

\* (3) Pit drainage. During construction and use of rock quarries, gravel pits, or borrow pits, runoff water shall be either diverted onto the forest floor or be passed through one or more settling basins as approved by the department.

(4) Rehabilitation required. All rock quarries, gravel pits, spoil disposal areas and borrow pits used after January 1, 1975 shall be reclaimed within 2 years from the time the rock or gravel source is either exhausted or abandoned.

(5) Rehabilitation standards. Where rehabilitation is required:

(a) Remove all deleterious material that has potential for damaging the public resource, the soil productivity, or that would prevent reforestation of an otherwise plantable area.

(b) Grade slopes to less than the angle of repose unless otherwise approved.

(c) Reforest in accordance with chapter 222-34 WAC to the extent practical.

(d) Seed unreforested exposed erodible soils with grass, clover or other ground cover.

\*(6) Major spoil disposal operations. Where a spoil disposal operation involves more than 1,000 cubic yards of spoils:

(a) The spoils shall be placed to provide drainage onto the forest floor without water ponding within the disposal area;

(b) The site shall be reforested in accordance with chapter 222-34 WAC to the extent practical; and

(c) If significant erosion of the spoils develops, the eroding areas shall be water barred and any unreforested areas shall be matted, mulched, or seeded with grass or ground cover.

**AMENDATORY SECTION** (Amending Order 551, Resolution No. 88-1, filed 9/21/88, effective 11/1/88)

WAC 222-30-010 POLICY—TIMBER HARVESTING. \*This section covers all removal of timber from forest lands in commercial operations, commercial thinning, salvage of timber, relogging merchantable material left after prior harvests, postharvest cleanup, and clearing of merchantable timber from lands being converted to other uses. It does not cover removal of incidental vegetation or removal of firewood for personal use. To the extent practical the department shall coordinate the activities on a multiple disciplinary planning approach. The riparian management zone requirements specified in this section are designed to provide protection for water quality and fisheries and wildlife habitat through ensuring present and future supplies of large organic debris for streams, snags, canopy cover, and a multistoried diverse forest adjacent to Type 1, 2 and 3 Waters. Wetland areas serve several significant functions in addition to timber production: Providing fish and wildlife habitat, protecting water quality, moderating and preserving water quantity. Wetlands may also contain unique or rare ecological systems. The wetland management zone and wetland requirements specified in this section are designed to protect these wetland functions when measured over the length of a harvest rotation, although some of the functions may be reduced until the midpoint of the timber rotation cycle. Landowners are encouraged to voluntarily increase wetland acreage and functions over the long-term.

(NOTE: OTHER LAWS OR REGULATIONS AND/OR PERMIT REQUIREMENTS MAY APPLY. SEE CHAPTER 222-50 WAC.)

**AMENDATORY SECTION** (Amending Order 551, Resolution No. 88-1, filed 9/21/88, effective 11/1/88)

WAC 222-30-020 HARVEST UNIT PLANNING AND DESIGN. (1) Logging system. The logging system should be appropriate for the terrain, soils, and timber type so yarding or skidding can be economically accomplished in compliance with these regulations.

\*(2) Landing locations. Locate landings to prevent damage to public resources. Avoid excessive excavation and filling.

\*(3) (Landing construction:

~~(a) Landings requiring sidecast or fill shall be no larger than reasonably necessary for safe operation of the equipment expected to be used.~~

~~(b) Where the average general slopes exceed 65 percent, fill material used in construction of landings shall be free of loose stumps and excessive accumulations of slash and shall be mechanically compacted where necessary and practical in layers by tractor to prevent soil erosion and mass soil movement. Chemical compacting agents may be used in accordance with WAC 222-38-020.~~

~~\*(c) Truck roads, skid or fire trails shall be outsloped or cross drained uphill of landings and the water diverted onto the forest floor away from the toe of any landing fill.~~

~~(d) Landings shall be sloped to minimize accumulation of water on the landing.~~

~~\*(e) Excavation material shall not be sidecast where there is high potential for material to enter below the ordinary high-water mark of any stream or the 50-year flood level of Type 1, 2, 3 or 4 Water.~~

~~\*(4) Riparian management zones. For the purpose of riparian management zone design the state shall be divided along an administrative line which approximates the change from the Western Washington timber types to the Eastern Washington timber types described as follows:~~

~~Beginning at the International Border and Okanogan National Forest boundary at the N1/4 corner Section 6, T. 40N, R. 24E., W.M., south and west along the Pasayten Wilderness boundary to the west line of Section 30, T. 37N, R. 19E.;~~

~~Thence south on range line between R. 18E. and R. 19E., to the Lake Chelan-Sawtooth Wilderness at Section 31, T. 35N, R. 19E.;~~

~~Thence south and east along the eastern wilderness boundary of Lake Chelan-Sawtooth Wilderness to the west line of Section 18, T. 31N, R. 19E. on the north shore of Lake Chelan;~~

~~Thence south on the range line between R. 18E. and R. 19E. to the SE corner of T. 28N, R. 18E.;~~

~~Thence west on the township line between T. 27N, and T. 28N to the NW corner of T. 27N, R. 17E.;~~

~~Thence south on range line between R. 16E. and R. 17E. to the Alpine Lakes Wilderness at Section 31, T. 26N, R. 17E.;~~

~~Thence south along the eastern wilderness boundary to the west line of Section 6, T. 22N, R. 17E.;~~

~~Thence south on range line between R. 16E. and R. 17E. to the SE corner of T. 22N, R. 16E.;~~

~~Thence west along township line between T. 21N, and T. 22N to the NW corner of T. 21N, R. 15E.;~~

~~Thence south along range line between R. 14E. and R. 15E. to SW corner of T. 20N, R. 15E.;~~

~~Thence east along township line between T. 19N, and T. 20N to the SW corner of T. 20N, R. 16E.;~~

~~Thence south along range line between R. 15E. and R. 16E. to the SW corner of T. 18N, R. 16E.;~~

~~Thence west along township line between T. 17N, and T. 18N to the SE corner of T. 18N, R. 14E.;~~

~~Thence south along range line between T. 14E. and R. 15E. to the SW corner of T. 14N, R. 15E.;~~

~~Thence south and west along Wenatchee National Forest Boundary to the NW corner of T. 12N, R. 14E.;~~

~~Thence south along range line between R. 13E. and R. 14E. to SE corner of T. 10N, R. 13E.;~~

~~Thence west along township line between T. 9N, and T. 10N to the NW corner of T. 9N, R. 12E.;~~

~~Thence south along range line between R. 11E. and R. 12E. to SE corner of T. 8N, R. 11E.;~~

~~Thence west along township line between T. 7N, and T. 8N to the Gifford Pinchot National Forest Boundary;~~

~~Thence south along Forest Boundary to SE corner of Section 33, T. 7N, R. 11E.;~~

~~Thence west along township line between T. 6N, and T. 7N to SE corner of T. 7N, R. 9E.;~~

~~Thence south along Skamania-Klickitat County line to Oregon-Washington state line.~~

(5)) Western Washington riparian management zones. These zones shall be measured horizontally from the ordinary high-water mark of Type 1, 2 or 3 Water and extend to the line where vegetation changes from wetland to upland plant community, or the line required to leave sufficient shade as required by WAC 222-30-040, whichever is greater, but shall not be less than 25 feet in width nor more than the maximum widths described in (c) of this subsection, provided that the riparian management zone width shall be expanded as necessary to include ~~((swamps, bogs, marshes))~~ wetlands or ponds adjacent to the stream. When the riparian management zone overlaps a Type A or B Wetland or a wetland management zone, the requirement which best protects public resources shall apply.

(a) Harvest units shall be designed so that felling, bucking, yarding or skidding, and reforestation can be accomplished in accordance with these regulations, including those regulations relating to stream bank integrity and shade requirements to maintain stream temperature ~~((control))~~. Where the need for additional actions or restrictions adjacent to waters not covered by the following become evident, WAC 222-12-050 and 222-12-060 may apply.

(b) When requested in writing by the applicant, the department shall assist in preparation of an alternate plan for the riparian management zone.

(c) Within the riparian management zone, there shall be trees left for wildlife and fisheries habitat as provided for in the chart below. Fifty percent or more of the trees shall be live and undamaged on completion of the harvest. The leave trees shall be randomly distributed where feasible; some clumping is allowed to accommodate operational considerations. The number, size, species and ratio of leave trees, deciduous to conifer, is specified by the bed material and average width of the water type within the harvest unit. Trees left according to (d) of this subsection may be included in the number of required leave trees in this subsection.

WATER TYPE/ AVERAGE WIDTH	RMZ MAXIMUM WIDTH	RATIO OF CONIFER TO DECIDUOUS/ MINIMUM SIZE LEAVE TREES	# TREES/1000 FT. EACH SIDE	
			GRAVEL/ COBBLE <10" DIAMETER	BOULDER/ BEDROCK
1 & 2 Water 75' & over	100'	representative of stand	50 trees	25 trees

WATER TYPE/ AVERAGE WIDTH	RMZ MAXIMUM WIDTH	RATIO OF CONIFER TO DECIDUOUS/ MINIMUM SIZE LEAVE TREES	# TREES/1000 FT. EACH SIDE	
			GRAVEL/ COBBLE <10" DIAMETER	BOULDER/ BEDROCK
1 & 2 Water under 75'	75'	representative of stand	100 trees	50 trees
3 Water 5' & over	50'	2 to 1/ 12" or next largest available	75 trees	25 trees
3 Water less than 5'	25'	1 to 1/ 6" or next largest available	25 trees	25 trees

"Or next largest available" requires that the next largest trees to those specified in the rule be left standing when those available are smaller than the sizes specified. Ponds or lakes which are Type 1, 2 or 3 Waters shall have the same leave tree requirements as boulder/bedrock streams.

(d) For wildlife habitat within the riparian management zone, leave an average of 5 undisturbed and uncut wildlife trees per acre at the ratio of 1 deciduous tree to 1 conifer tree equal in size to the largest existing trees of those species within the zone. Where the 1 to 1 ratio is not possible, then substitute either species present. Forty percent or more of the leave trees shall be live and undamaged on completion of harvest. Wildlife trees shall be left in clumps whenever possible.

(e) When 10 percent or more of the harvest unit lies within ~~((the))~~ any combination of a riparian management zone of Type 1, 2 or 3 Waters or a wetland management zone and the harvest unit is a clearcutting of 30 acres or less, leave not less than 50 percent of the trees required in (c) of this subsection.

~~\*(((6)))~~ (4) Eastern Washington riparian management zones. These zones shall be measured horizontally from the ordinary high-water mark of Type 1, 2 or 3 Waters and extend to the line where vegetation changes from wetland to upland plant community, or to the line required to leave sufficient shade as required by WAC 222-30-040, whichever is greater, but shall not be less than the minimum width nor more than the maximum widths described in (c) of this subsection, provided that the riparian management zone width shall be expanded as necessary to include ~~((swamps, bogs, marshes,))~~ wetlands or ponds adjacent to the stream. When the riparian management zone overlaps a Type A or B Wetland or a wetland management zone, the requirement which best protects public resources shall apply.

(a) Harvest units shall be designed so that felling, bucking, yarding or skidding, and reforestation can be accomplished in accordance with these regulations, including those regulations relating to stream bank integrity and shade requirements to maintain stream temperature ~~((control))~~. Where the need for additional actions or restrictions adjacent to waters not covered by the following become evident, WAC 222-12-050 and 222-12-060 may apply.

(b) When requested in writing by the applicant, the department shall assist in preparation of an alternate plan for the riparian management zone.

(c) Within the riparian management zone, there shall be trees left for wildlife and fisheries habitat as provided for below. Fifty percent or more of the trees shall be live and undamaged on completion of the harvest. The leave trees shall be randomly distributed where feasible; some clumping is allowed to accommodate operational considerations.

(i) The width of the riparian management zone shall be based on the adjacent harvest type as defined in WAC 222-16-010(33) Partial cutting. When the adjacent unit harvest type is:

Partial cutting – The riparian management zone width shall be a minimum of 30 feet to a maximum of 50 feet on each side of the stream.

Other harvest types – The riparian management zone shall average 50 feet in width on each side of the stream with a minimum width of 30 feet and a maximum of 300 feet on each side of the stream.

(ii) Leave tree requirements within the riparian management zones of Type 1, 2 or 3 Waters:

(A) Leave all trees 12 inches or less in diameter breast height (dbh); and

(B) Leave all ~~((snags))~~ wildlife reserve trees within the riparian management zone ~~((that))~~ where operations in the vicinity do not violate the state safety regulations (chapter 296-54 WAC ((department of labor and industries, safety division)) and chapter 49.17 RCW administered by department of labor and industries, safety division); and

(C) Leave 16 live conifer trees/acre between 12 inches dbh and 20 inches dbh distributed by size, as representative of the stand; and

(D) Leave 3 live conifer trees/acre 20 inches dbh or larger and the 2 largest live deciduous trees/acre 16 inches dbh or larger. Where these deciduous trees do not exist, and where 2 ~~((snags))~~ wildlife reserve trees/acre 20 inches or larger do not exist, substitute 2 live conifer trees/acre 20 inches dbh or larger. If live conifer trees of 20 inches dbh or larger do not exist within the riparian management zone, then substitute the 5 largest live conifer trees/acre; and

(E) Leave 3 live deciduous trees/acre between 12 inches and 16 inches dbh where they exist.

(iii) Minimum leave tree requirements per acre for Type 1, 2 and 3 Waters. Trees left for (c)(ii) of this subsection shall be included in the minimum counts.

(A) On streams with a boulder/bedrock bed, the minimum leave tree requirements shall be 75 trees/acre 4 inches dbh or larger.

(B) On streams with a gravel/cobble (less than 10 inches diameter) bed, the minimum leave tree requirement shall be 135 trees/acre 4 inches dbh or larger.

(C) On lakes or ponds the minimum leave tree requirement shall be 75 trees/acre 4 inches dbh or larger.

Note: (See the Forest Practices Board Manual for assistance in calculating trees/acre and average RMZ widths.)

(d) When 10 percent or more of the harvest unit lies within ~~((the))~~ any combination of a riparian management zone of Type 1, 2 or 3 Waters or a wetland management zone and either the harvest unit is a clearcutting of 30 acres or less or the harvest unit is a partial cutting of 80 acres or less, leave not less than 50 percent of the trees required in (c) of this subsection. (See WAC 222-16-010(33) Partial cutting.)

~~((7) Type 4 Water))~~ \*(5) Riparian leave tree areas. The department will require trees to be left along Type 4 Water where such practices are necessary to protect public resources. Where such practices are necessary leave at least 25 conifer or deciduous trees, 6 inches in diameter or larger, on each side of every 1000 feet of stream length within 25 feet of the stream. The leave trees may be arranged to accommodate the operation.

(6) Forested wetlands. Within the wetland, unless otherwise approved in writing by the department, harvest methods shall be limited to low impact harvest or cable systems. Where feasible, at least one end of the log shall be suspended during yarding.

(a) When forested wetlands are included within the harvest area, landowners are encouraged to leave a portion (30 to 70%) of the wildlife reserve tree requirement for the harvest area within a wetland. In order to retain undisturbed habitat within forested wetlands, these trees should be left in clumps. Leave tree areas should be clumped adjacent to streams, riparian management zones, or wetland management zones where possible and they exist within forested wetlands. Green recruitment trees should be representative of the size and species found within the wetland. Leave nonmerchantable trees standing where feasible.

(b) If a RMZ or WMZ lies within a forested wetland, the leave tree requirement associated with those areas may be counted toward the percentages in (a) of this subsection.

(c) If the conditions described in (a) and (b) of this subsection are met, the distribution requirements for wildlife reserve trees and green recruitment trees (subsection (11)(e) of this section) are modified as follows: For purposes of distribution, no point within the harvest unit shall be more than 1000 feet from a wildlife reserve tree and green recruitment tree retention area.

(d) Approximate determination of the boundaries of forested wetlands greater than 5 acres shall be required. Approximate boundaries and areas shall be deemed to be sufficient for harvest operations.

(e) The department shall consult with the department of wildlife, the department of fisheries, and affected Indian tribes about site specific impacts of forest practices on wetland-sensitive species in forested wetlands.

(7) Wetland management zones (WMZ). These zones shall apply to Type A and B Wetlands, 0.5 acre in size or larger, and shall be measured horizontally from the wetland edge or the point where the nonforested wetland becomes a forested wetland, as determined by the method described in the board manual, and shall be of an average width as described in (a) of this subsection. These zones shall not be less than the minimum nor more than the maximum widths described in (a) of this subsection. When these zones overlap a riparian management zone



the requirement which best protects public resources shall apply.

(a) Wetland management zones (WMZ) shall have variable widths based on the size of the wetland and the wetland type, described as follows:

Wetland Type	Acres of Nonforested Wetland	Maximum WMZ Width	Average WMZ Width	Minimum WMZ Width
A	Greater than 5	200 feet	100 feet	50 feet
A	0.5 to 5	100 feet	50 feet	25 feet
A Bog/Fen	0.25 to 0.5	100 feet	50 feet	25 feet
B	Greater than 5	100 feet	50 feet	25 feet
B	0.5 to 5			25 feet
B	0.25 to 0.5	No WMZ Required		

(b) Within the WMZ, leave a total of 75 trees per acre of WMZ greater than 6 inches dbh in Western Washington and greater than 4 inches dbh in Eastern Washington, 25 of which shall be greater than 12 inches dbh including 5 trees greater than 20 inches dbh, where they exist. Leave trees shall be representative of the species found within the WMZ.

(c) Retain wildlife reserve trees where feasible. Type 1 and 3 wildlife reserve trees may be counted among, and need not exceed, the trees required in (b) of this subsection. Leave all cull logs on site.

(d) Partial-cutting or removal of groups of trees is acceptable within the WMZ. The maximum width of openings created by harvesting within the WMZ shall not exceed 100 feet as measured parallel to the wetland edge. Openings within WMZs shall be no closer than 200 feet. Landowners are encouraged to concentrate leave trees within the WMZ to the wetland edge.

(e) Tractors, wheeled skidders, or other ground based harvesting systems shall not be used within the minimum WMZ width without written approval of the department.

(f) When 10% or more of a harvest unit lies within any combination of a wetland management zone or a riparian management zone of Type 1, 2, or 3 Waters and either the harvest unit is a clearcut of 30 acres or less or the harvest unit is a partial cut of 80 acres or less, leave not less than 50% of the trees required in (b) of this subsection.

\* (8) Nonforested wetlands (Type A or B). Within the boundaries of Type A or B Wetlands the following shall apply:

(a) Individual trees or forested wetland areas less than 0.5 acre in size may occur. These trees have a high habitat value to the nonforested wetland. Leave individual trees or forested wetlands less than 0.5 acre. These trees may be counted toward the WMZ requirements.

(b) Harvest of upland areas or forested wetlands which are surrounded by Type A or B Wetlands must be conducted in accordance with a plan, approved in writing by the department.

(c) No timber shall be felled into or cable yarded across Type A or B Wetlands without written approval of the department.

((8)) (9) Future productivity. Harvesting shall leave the land in a condition conducive to future timber production except:

(a) To the degree required for riparian management zones; or

(b) Where the lands are being converted to another use or classified urban lands as specified in WAC 222-34-050.

((9)) (10) Wildlife habitat. This subsection is designed to encourage timber harvest practices that would protect wildlife habitats, provided, that such action shall not unreasonably restrict landowners action without compensation.

(a) The applicant should make every reasonable effort to cooperate with the department of wildlife to identify critical wildlife habitats (state) as defined by the board. Where these habitats are known to the applicant, they shall be identified in the application or notification.

(b) ((Where a critical wildlife habitat has been identified the applicant shall consider reasonable means of protection thereof as part of the proposed harvesting operation:

(c)) Harvesting methods and patterns in established big game winter ranges should be designed to insure adequate access routes and escape cover where practical.

(i) Where practical, cutting units should be designed to conform with topographical features.

(ii) Where practical on established big game winter ranges, cutting units should be dispersed over the area to provide cover, access for wildlife, and to increase edge effect.

((10)) (11) Wildlife reserve tree management. In areas where ((this will not create a significant fire or)) leaving wildlife reserve trees under this section will not create a significant fire hazard, or significant hazard to overhead power lines and operations that are proposed in the vicinity of wildlife reserve trees will not create a significant safety or residential hazard nor conflict with achieving conformance with the limitation of or performance with the provisions of chapter 76.04 RCW (snag falling law) and chapter 49.17 RCW (safety), ((a reasonable number of snags)) wildlife reserve trees will be left to protect habitat for cavity nesting wildlife in accordance with the following:

(a) In Western Washington, for each acre harvested 3 wildlife reserve trees, 2 green recruitment trees, and 2 down logs shall be left. In Eastern Washington for each acre harvested 2 wildlife reserve trees, 2 green recruitment trees, and 2 down logs shall be left. Type 1 wildlife reserve trees may be counted, at the landowner's option, either as a wildlife reserve tree or as a green recruitment tree. If adequate wildlife reserve trees are not available, no additional green recruitment trees will be required as substitutes. Landowners shall not under any circumstances be required to leave more than 2 green recruitment trees per acre for the purpose of wildlife reserve tree recruitment, or be required to leave Type 3 or 4 wildlife reserve trees.

(b) In Eastern Washington, for 5 years from the effective date of this subsection where over-story harvest of seed trees left for purpose of reforestation are proposed and less than 10 trees per acre will be harvested within the 5-year period, 50% of the green recruitment trees otherwise required in this subsection may be left.

(c) In Western Washington, only those wildlife reserve trees 10 or more feet in height and 12 or more inches dbh shall be counted toward wildlife reserve tree retention requirements. In Eastern Washington, only those wildlife reserve trees 10 or more feet in height and 10 or more inches dbh shall be counted toward wildlife reserve tree retention requirements. Green recruitment trees, 10 or more inches dbh and 30 or more feet in height and with at least 1/3 of their height in live crown, left standing after harvest may be counted toward green recruitment tree requirements. Green recruitment trees and/or wildlife reserve trees left to meet other requirements of the rules or those left voluntarily by the landowner shall be counted toward satisfying the requirements of this section. Large, live defective trees with broken tops, cavities, and other severe defects are preferred as green recruitment trees. Only down logs with a small end diameter greater than or equal to 12 inches and a length greater than or equal to 20 feet or equivalent volume shall be counted under (a) of this subsection. Large cull logs are preferred as down logs.

(d) In the areas where wildlife reserve trees are left, the largest diameter wildlife reserve trees shall be retained to meet the specific needs of cavity nesters. Where the opportunity exists, larger trees with numerous cavities should be retained and count as recruitment trees.

(e) In order to facilitate safe and efficient harvesting operations, wildlife reserve trees and recruitment trees may be left in clumps. For purposes of distribution, no point within the harvest unit shall be more than 800 feet from a wildlife reserve tree or green recruitment tree retention area. Subject to this distribution requirement, the location of these retention areas and the selection of recruitment trees shall be at the landowner's discretion. Closer spacing of retention areas through voluntary action of the landowner is encouraged. Wildlife reserve tree and green recruitment tree retention areas may include, but are not limited to, riparian management zones, riparian leave tree areas, other regulatory leave areas, or voluntary leave areas that contain wildlife reserve trees and/or green recruitment trees.

(f) In order to provide for safety, landowners may remove any Type 3 or 4 wildlife reserve tree which poses a threat to humans working, recreating, or residing within the hazard area of that tree. In order to provide for fire safety, the distribution of wildlife reserve tree retention areas, described in (e) of this subsection, may be modified as necessary based on a wildlife reserve tree management plan proposed by the landowner and approved by the department.

## NEW SECTION

**WAC 222-30-025 EVEN-AGED HARVEST—SIZE AND TIMING.** Except as provided in WAC 222-30-110, unit size and timing of timber harvesting by even-aged harvest methods is subject to the following requirements:

(1) Timber harvest which would result in an area larger than one hundred twenty acres and smaller than or equal to two hundred forty acres harvested by even-aged harvest methods on land owned or controlled by

one landowner shall be reviewed by an interdisciplinary team, if the department determines that review is necessary. The area harvested by even-aged harvest methods, for the purposes of this subsection, shall be determined in accordance with subsection (3) of this section.

(2) Timber harvest which would result in an area larger than two hundred forty acres harvested by even-aged harvest methods on land owned or controlled by one landowner shall be prohibited. The area harvested by even-aged harvest method for the purposes of this subsection shall be determined in accordance with subsection (3) of this section.

(3) In calculating areas harvested by even-aged harvest methods, the area harvested by even-aged harvest methods shall include the acreage of that harvest unit and, all contiguous acreage harvested by even-aged harvest methods which is owned or controlled by the same landowner, except that acreage harvested by even-aged harvest methods sharing 10% or less of the common perimeter with the harvest unit under consideration shall not be considered contiguous for the purposes of this section.

(4) Harvest units shall be designed so that each harvest unit meets at least one of the following criteria:

(a) At least thirty percent of the unit's perimeter is in stands of trees that are thirty years of age or older;

(b) At least sixty percent of the unit's perimeter is in stands of trees that are fifteen years of age or older; or

(c) At least ninety percent of the unit's perimeter is in stands of trees that have survived on site a minimum of five growing seasons or, if not, have reached an average height of four feet.

Evaluation of unit perimeters is subject to the conditions specified in subsection (6) of this section.

(5) The requirements of subsections (2), (3), and (4) of this section shall apply only to timber harvest by even-aged harvest methods and shall not apply to timber harvest to salvage timber damaged by wind, disease, insects, fire, or other natural causes or to forest practices involving the clearing of land of brush or understocked hardwoods to convert to managed hardwoods or conifers.

(6) In evaluating the perimeters of harvest units pursuant to subsection (4) of this section, the following conditions shall apply:

(a) The following shall be treated as fully stocked, mature stands that will not be counted as contiguous acreage harvested by even-aged methods for the purposes of subsections (1) and (2) of this section and which will be counted as thirty-year-old stands for the purposes of subsection (4) of this section:

(i) In western Washington, a riparian management zone or wetland management zone that is twice the width with twice the tree count required by WAC 222-30-020(3) along Type 1, 2, or 3 Waters;

(ii) In eastern Washington, a riparian management zone or wetland management zone that is the width required by WAC 222-30-020(4);

(iii) Designated upland management areas;

(iv) Lands in a shoreline of state-wide significance where harvest is limited under RCW 90.58.150;

(v) The portions of a perimeter consisting of land in uses other than forest land, such as land in agricultural

or residential use and natural openings, and land not owned or controlled by the landowner who has proposed the harvest unit subject to the application under consideration;

(b) A stand of trees other than those described in (a) of this subsection shall be treated as a certain age class only if the stand is at least three hundred feet wide;

(c) Timber harvest units subject to an approved application or a notification for timber harvesting shall be treated as if the timber harvesting operation proposed in the application or notification were completed and regeneration not yet established.

(7) This section shall not apply to notifications or applications approved before July 1, 1992, or to one renewal of those applications, and shall not apply to timber that the landowner or operator demonstrated to the department is subject to a cutting right created by written contract before July 1, 1992, which cutting right would expire before all the timber subject to it could reasonably be harvested.

**AMENDATORY SECTION** (Amending Order 535, filed 11/16/87, effective 1/1/88)

~~WAC 222-30-040 ((TEMPERATURE CONTROL)) SHADE REQUIREMENTS TO MAINTAIN STREAM TEMPERATURE. \* (1) ((Determination of temperature sensitivity for Type 1, 2 and 3 Waters shall be based upon field data or records, from a verified water temperature model or method acceptable to the department, that demonstrate significant adverse water temperature impacts following the proposed timber harvest and shade removal. Any designation as to whether or not waters are temperature sensitive shall be made by the department prior to the deadline for approval or disapproval of the application for harvest.~~

~~\* (2) Shade requirements. Within the riparian management zone along those Type 1, 2 and 3 Waters designated as temperature sensitive, unless a waiver is granted by the department under subsection (3) of this section, the operator shall:~~

~~(a) Leave all nonmerchantable vegetation which provides mid-summer and mid-day shade of the water surface; and~~

~~(b) Leave sufficient merchantable timber, if any, necessary to retain 50 percent of the summer mid-day shade of the water surface, provided that the department shall require leaving 75 percent of the shade where it determines that the mean of the maximum summer daily ambient water temperatures, for a 7-day period, exceeds 60 degrees before logging. (See the forest practices board manual part 2 for methods of shade determination.)~~

~~\* (3)) Determination of adequate shade. The temperature prediction method in subsections (2) and (3) of this section shall be used to determine appropriate shade levels for flowing Type 1, 2, and 3 Waters to prevent excessive water temperatures which may have detrimental impact on aquatic resources.~~

~~\* (2) Temperature prediction method. In addition to the riparian management zone requirements, leave trees shall be retained in riparian management zones on flowing Type 1, 2, and 3 Waters as provided by the method~~

described in the board manual which includes the following considerations:

(a) Minimum shade retention requirements; and

(b) Regional water temperature characteristics; and

(c) Elevation; and

(d) Temperature criteria defined for stream classes in WAC 173-203-030.

\* (3) Leave tree requirements for shade. The method described in subsection (2) of this section shall be used to establish the minimum shade cover based on site specific characteristics. When site specific data indicate that pre-harvest conditions do not meet the minimums established by the method, no additional shade removal from riparian management zones will be allowed.

(4) Waivers. The department may waive or modify the shade requirements where ((the applicant)):

(a) ((Shows a high probability of windthrow and agrees to replant the riparian management zone within the first planting season after harvest; or

(b)) The applicant agrees to a staggered setting program producing equal or greater shade requirements to maintain stream temperature ((control)); or

((c)) (b) The applicant provides alternative means of stream temperature control satisfactory to the department; or

(c) The temperature method indicates that additional shade will not affect stream temperature.

**AMENDATORY SECTION** (Amending Order 535, filed 11/16/87, effective 1/1/88)

**WAC 222-30-050 FELLING AND BUCKING.**

**\* (1) Falling along water.**

(a) No trees will be felled into Type 1, 2 and 3 Waters, or Type A or B Wetlands except trees which cannot practically and safely be felled outside the stream, lake or pond using techniques in general use and these trees must then be removed promptly.

Such felling and removing in Type 1, 2 or 3 Waters shall comply with the hydraulic project approval of the departments of fisheries or wildlife.

(b) Within ((the)) riparian management zones, and wetland management zones fall trees favorable to the lead consistent with safety standards to yard or skid away from the waters. The use of directional falling, lining, jacking and staged falling techniques are encouraged.

(c) Trees may be felled into Type 4 Water if logs are removed as soon thereafter as practical. See forest practices board manual guidelines for clearing slash and debris from Type 4 and 5 Water.

**\* (2) Bucking in water.**

(a) No bucking or limbing shall be done on trees or portions thereof lying between the banks of Type 1, 2 or 3 Waters or in open water areas of Type A Wetlands, except as necessary to remove the timber from the water.

(b) Where bucking or limbing is done between the banks of a Type 4 Water, care shall be taken to minimize accumulation of slash in the water.

\* (3) Falling near riparian management zones, wetland management zones and setting boundaries. Reasonable care shall be taken to avoid felling trees into riparian

management zones, wetland management zones and areas outside the harvest unit.

(4) Falling in selective and partial cuts. Reasonable care shall be taken to fall trees in directions that minimize damage to residual trees.

AMENDATORY SECTION (Amending Order 535, filed 11/16/87, effective 1/1/88)

WAC 222-30-060 CABLE YARDING. \*(1) Type 1, 2 and 3 Waters. No timber shall be cable yarded in or across a Type 1, 2 or 3 Waters except where the logs will not materially damage the bed of waters, banks or riparian management zones and removals from Type 1, 2 or 3 Water have hydraulic project approval of the departments of fisheries or wildlife.

\*(2) Type A or B Wetlands. No timber shall be cable yarded in or across Type A or B Wetlands without written approval from the department.

\*(3) Deadfalls. Any logs which are firmly embedded in the bed of a Type 1, 2, 3 and 4 Waters shall not be removed or unnecessarily disturbed without approval of the departments of fisheries or wildlife.

\*((3)) (4) Yarding in riparian management zones and wetland management zones. Where timber is yarded from or across a riparian management zone, or wetland management zone reasonable care shall be taken to minimize damage to the vegetation providing shade to the stream or open water areas and to minimize disturbance to understory vegetation, stumps and root systems. Where practical and consistent with good safety practices, logs shall be yarded in the direction in which they lie and away from Type A or B Wetlands or Type 1, 2 and 3 Waters until clear of the wetland management zone or riparian management zone.

\*((4)) (5) Direction of yarding.

(a) Uphill yarding is preferred.

(b) Where downhill yarding is used, reasonable care shall be taken to lift the leading end of the log to minimize downhill movement of slash and soils.

\*(c) When yarding parallel to a Type 1, 2 or 3 Water channel below the 50-year flood level or within the riparian management zone, reasonable care shall be taken to minimize soil disturbance and to prevent logs from rolling into the stream, lake, pond, or riparian management zone.

AMENDATORY SECTION (Amending Order 535, filed 11/16/87, effective 1/1/88)

WAC 222-30-070 TRACTOR AND WHEELED SKIDDING SYSTEMS. \*(1) ((Type 1, 2, 3 and 4 Waters)) Typed waters and wetlands.

(a) Tractor and wheeled skidders shall not be used in Type 1, 2 or 3 Water, except with approval by the department and with a hydraulic project approval of the departments of fisheries or wildlife.

(b) In order to maintain wetland water movement and water quality, and to prevent soil compaction, tractor or wheeled skidders shall not be used in Type A or B Wetlands without prior written approval of the department.

(c) Within all wetlands, tractors and wheeled skidder systems shall be limited to low impact harvest systems.

Ground based logging systems operating in wetlands shall only be allowed within wetlands during periods of low soil moisture or frozen soil conditions.

(d) Skidding across any flowing Type 4 Water shall be minimized and when done, temporary stream crossings shall be used, if necessary, to maintain stream bed integrity.

((e)) (e) Whenever skidding in or across any type water, the direction of log movement between stream banks shall be as close to right angles to the stream channel as is practical.

\*(2) Riparian management zone.

(a) Logging will be permitted within the zone. However, any use of tractors, wheeled skidders, or other yarding machines within the zone must be as described in an approved forest practices application or otherwise approved in writing by the department.

(b) Where skidding in or through the riparian management zone is necessary, the number of skidding routes through the zone shall be minimized.

(c) Logs shall be skidded so as to minimize damage to leave trees and vegetation in the riparian management zone, to the extent practical and consistent with good safety practices.

((3)) \*(3) Wetlands management zones.

(a) Logging will be permitted within wetland management zones.

(b) Where feasible logs shall be skidded at least with one end suspended from the ground so as to minimize soil disturbance and damage to leave trees and vegetation in the wetland management zone.

(c) Tractors, wheeled skidders, or other ground based harvesting systems shall not be used within the minimum WMZ width without written approval of the department.

\*(4) Deadfalls. Logs firmly embedded in the bed or bank of Type 1, 2, 3 or 4 Waters shall not be removed or unnecessarily disturbed without hydraulic project approval of the departments of fisheries or wildlife.

\*((4)) (5) Moisture conditions. Tractor and wheeled skidders shall not be used on exposed erodible soils or saturated soils when soil moisture content is so high that unreasonable soil compaction, soil disturbance, or wetland, stream, lake or pond siltation would result.

((5)) (6) Protection of residual timber. Reasonable care shall be taken to minimize damage from skidding to the stems and root systems of residual timber and to young reproduction.

\*((6)) (7) Skid trail construction.

(a) Skid trails shall be kept to the minimum feasible width.

(b) Reasonable care shall be taken to minimize the amount of sidecast required and shall only be permitted above the 50-year flood level.

(c) Skid trails shall be outsloped where practical, but be insloped where necessary to prevent logs from sliding or rolling downhill off the skid trail.

\*((7)) (8) Skid trail maintenance. Upon completion of use and termination of seasonal use, skid trails on slopes in exposed soils shall be water barred where necessary to prevent soil erosion.

\*~~((8))~~ (9) Slope restrictions. Tractor and wheeled skidders shall not be used on slopes where in the opinion of the department this method of operation would cause unnecessary or material damage to a public resource.

**AMENDATORY SECTION** (Amending Order 535, filed 11/16/87, effective 1/1/88)

**WAC 222-30-090 POSTHARVEST SITE PREPARATION.** Unless the application or notification indicates that the landowner or forest landowner specifically agrees to assume responsibility for compliance with this section, the operator shall leave the site in a condition suitable for reforestation following any clear cutting, or any partial cutting west of the summit of the Cascades where 80 percent or more of the cubic volume is removed within any 5 consecutive years unless the department determines that the live trees remaining will reasonably utilize the timber growing capacity of the soils. Lands being converted to another use or classified as urban development lands under WAC 222-34-050 are exempt.

The following site preparation is required when necessary to establish a condition suitable for reforestation:

(1) Cutting, slashing, or other treatment of all non-commercial tree species, other competing vegetation, and nonmerchantable size trees commonly known as "whips" which will not reasonably utilize the growing capacity of the soil except in ~~((the))~~ wetland management zones, riparian management zones; or

(2) Pile or windrow slash; or

(3) Mechanically scatter slash; or

(4) Leave the cutover area in a condition for controlled broadcast burning, and subsequently burn.

**AMENDATORY SECTION** (Amending Order 535, filed 11/16/87, effective 1/1/88)

**WAC 222-30-100 SLASH DISPOSAL.** (1) Slash disposal techniques:

\*~~(a) Any conventional method of slash disposal may be used, except in Type A or B Wetlands, wetland management zones, and riparian management zones and on sites where the department determines that a particular method would cause unreasonable risk to public resources or unreasonably damage site productivity(~~(, any conventional method of slash disposal may be used, such as:))~~. Conventional methods of slash disposal include the following: Controlled broadcast burning; pile or windrow and burn; pile or windrow without burning; mechanical scatter and compaction; scarification; chip, mulch or lop and scatter; burying; and physical removal from the forest lands: PROVIDED, That on land shown to have low productivity potential the landowner or operator shall obtain the department's approval of its regeneration plan prior to utilizing controlled broadcast burning as a slash disposal technique. In riparian management zones, slash disposal shall be by hand, unless approved by the department. Scarification shall not be allowed within wetlands. Machine piling is discouraged in wetlands.~~

(b) All slash burning requires a burning permit from the department which provides for compliance with the

smoke management plan and reasonable care to ~~((pre-vent damage to))~~ protect Type A and B Wetlands, wetland management zones, riparian management zones, soil, residual timber, public resources, and other property.

\*~~(c)~~ Location of slash piles. Except where burning will be completed before the next ordinary high-water season, slash shall not be piled or windrowed below the 50-year flood level of any Type 1, 2, 3 or 4 Water or in locations from which it could be expected to enter any stream, lake or pond.

(2) Slash isolation, reduction, or abatement is required when the department determines there is an extreme fire hazard according to law (see WAC 332-24-360).

(3) Slash disposal is required where the forest landowner has applied for and been granted an extension of time for reforestation on the grounds that slash disposal is necessary or desirable before reforestation.

\*~~(4)~~ Removing slash and debris from streams.

"Slash" or "debris" which can reasonably be expected to cause significant damage to the public resource shall be removed from Type 1, 2, 3 or 4 Waters, to above the 50-year flood level and left in a location or manner minimizing risk of re-entry into the stream, lake or pond and if substantial accumulations of slash exist below the 50-year flood level of Type 1, 2, 3 or 4 Waters, slash disposal is required. See the forest practices board manual for "Guidelines for clearing slash and debris from Type 4 and 5 Waters."

\*~~(5)~~ Fire trails.

(a) Construct dips, water bars, cross drainage and ditches as needed to control erosion.

(b) Reasonable care shall be taken to minimize excavation during fire trail construction and sidecast shall only be permitted above the 50-year flood level.

~~(c) Fire trails shall not be located within Type A or B Wetlands, wetland management zones, or riparian zones without prior written approval of the department. Hand constructed fire trails are preferred within forested wetlands. When machine built fire trails are necessary for control of burning, trail width and excavation shall be minimized.~~

## **NEW SECTION**

**WAC 222-30-110 TIMBER HARVESTING ON ISLANDS.** On an island:

(1) A landowner shall not harvest by clearcut so that more than forty contiguous acres of that landowner's forest land are in a clearcut condition;

(2) Forest land harvested by clearcut remains in the clearcut condition until it has reached canopy closure or it has been reforested for at least ten years;

(3) Clearcut harvest units are contiguous unless separated by a buffer at least two hundred feet wide that has reached canopy closure, has been reforested for at least ten years, or is in a land use other than timber production.

(4) Within two hundred feet of the ordinary high-water mark of saltwater timber harvest shall be by selective harvest only, so that no more than thirty percent of the merchantable trees are harvested in any ten-year

period: PROVIDED, That other timber harvesting methods may be permitted in those limited instances where the topography, soil conditions, or silvicultural practices necessary for regeneration render selective harvest ecologically detrimental: PROVIDED FURTHER, That harvest by clearcut on lands being converted to another use may be approved.

(5) The requirements of this section shall not apply to timber harvest to salvage timber damaged by wind, disease, insects, fire, or other natural causes.

(6) This section shall not apply to notifications or applications approved before July 1, 1992, or to one renewal of those applications, and shall not apply to timber that the landowner or operator demonstrated to the department is subject to a cutting right created by written contract before July 1, 1992, which cutting right would expire before all the timber subject to it could reasonably be harvested.

**AMENDATORY SECTION** (Amending Resolution No. 82-1, filed 8/3/82, effective 10/1/82)

WAC 222-38-010 POLICY—FOREST CHEMICALS. Chemicals perform important functions in forest management. The purpose of these regulations is to regulate the handling, storage and application of chemicals in such a way that the public health, ((soils)) lands, fish, wildlife ((and)), aquatic habitat, and water quality will not be endangered by contamination. This section in no way modifies the state department of agriculture regulations governing chemicals.

(NOTE: OTHER LAWS AND REGULATIONS AND/OR PERMIT REQUIREMENTS MAY APPLY. SEE CHAPTER 222-50 WAC.)

**AMENDATORY SECTION** (Amending Order 551, Resolution No. 88-1, filed 9/21/88, effective 11/1/88)

WAC 222-38-020 HANDLING, STORAGE, AND APPLICATION OF PESTICIDES. \*(1) No pesticide leakage, contamination, pollution.

(a) ~~((No person shall transport, handle, store, load, apply, or dispose of any pesticide, pesticide container or apparatus in such a manner as to pollute water supplies or waterways, or cause damage or injury to land, including humans, desirable plants, and animals.~~

~~(b) The department or the department of agriculture may suspend further use of any equipment responsible for chemical leakage, until the deficiency has been corrected to the satisfaction of the department suspending its usage.~~

~~\*(2) Streams, lakes and public waters. No person shall pollute streams, lakes, and other public water supplies in their pesticide loading and mixing operation. Use devices or procedures to prevent "back siphoning" such as providing an air gap or reservoir between the water source and the mixing tank.~~

~~\*(3)) Transportation, handling, storage, loading, application, and disposal of pesticides shall be consistent with applicable label requirements and other state and federal requirements.~~

\*(2) Mixing and ((handling)) loading areas.

(a) Mix ~~((chemicals))~~ pesticides and clean tanks and equipment only where any accidental spills would not enter ~~((any water types))~~ surface water or wetlands.

(b) ~~((Landing))~~ Storage and loading areas should be located where accidental spillage of ~~((chemicals))~~ pesticides will not ~~((cause them to become a contaminant))~~ enter surface water or wetlands. If any ~~((chemical))~~ pesticide is spilled, immediate appropriate procedures should be taken to contain ~~((or neutralize))~~ it.

(c) Use devices or procedures to prevent "back siphoning" such as providing an air gap or reservoir between the water source and the mixing tank.

~~\*((4))~~ (3) Riparian management zone. ~~((Chemical))~~ Pesticide treatments within the riparian management zone shall be by hand unless the department has approved a site specific plan with another method of treatment.

\*(4) Wetland management zone. Pesticide treatment within the wetland management zone shall be by hand unless the department has approved a site specific plan with another method of treatment.

\*(5) Aerial application of pesticides.

(a) To keep ~~((chemicals))~~ pesticides out of the water, leave a 50 foot buffer strip on ~~((Type 1, 2, 3 and flowing Type 4 and 5 Waters))~~ all typed waters, except segments of Type 4 and 5 Waters with no surface water and other areas of open water, such as ponds or sloughs. ~~((Do not spray chemicals in buffer strips or riparian management zones. Provided that fertilizers may be applied to within 25 feet of the water.))~~

(b) Apply the initial swath parallel to the buffer strip in (a) of this subsection ~~((on Type 1, 2, 3 or flowing Type 4 and 5 Waters. Parallel flight adjacent to all buffer strips shall be required))~~ unless a deviation is approved in advance by the department. Drift control agents shall be required adjacent to buffer strips. Avoid applications that might result in drift causing direct entry of pesticides into riparian management zones, Type A and B Wetlands, wetland management zones, and all typed waters, except segments of Type 4 and 5 Waters with no surface water.

(c) Use a bucket or spray device capable of immediate shutoff.

(d) Shut off ~~((chemical application))~~ spray equipment during turns and over open water.

~~((Do not allow direct entry of chemicals into any Type 1, 2, 3 or flowing Type 4 and 5 Waters.~~

~~((f))~~ Leave at least a 200 foot buffer strip around residences and 100 foot buffer strip adjacent to lands used for agriculture unless such residence or farmland is owned by the forest landowner or the aerial application is acceptable to the resident or landowner.

~~((g))~~ (f) The landowner shall identify for the operator the units to be sprayed and the untreated areas within the units ~~((so they are visible from the air))~~ with appropriately marked aerial photos or detailed planimetric maps. Before application of the ~~((chemical))~~ pesticide an over-flight of the area shall be made by the pilot ~~((and a responsible agent of the landowner))~~ with the marked photos or maps.

~~((h))~~ (g) Aerial chemical application areas shall be posted by the landowner by signing at significant points

of regular access at least 5 days prior to treatment. Posting shall remain at least 15 days after the spraying is complete. The department may require an extended posting period in areas where human use or consumption of plant materials is probable. Posting at formal, signed trailheads that are adjacent to aerially treated units is required. The signs will contain the name of the product used, date of treatment, ~~((and))~~ a contact telephone number, and any applicable restrictions.

~~((i) Any water purveyor of a certified Class 1, 2 or 3 system, as defined in WAC 248-54-015, may request the department to designate lands within the watershed upstream of the surface water intake of the affected water supply as an "area of water supply interest." Prior to requesting such designation, the purveyor shall personally or by certified mail deliver to each landowner of record within such area, a copy of the request, a map showing proposed area boundaries and the name and address of the purveyor. The department may designate an "area of water supply interest" in such area(s) where it determines that the aerial application of pesticides may adversely impact the affected water supply. Where the department has designated an "area of water supply interest," it shall notify the purveyor of any Class IV Forest Practices for the aerial application of pesticides.))~~

~~\* (6) ((Stream protection=))~~ Ground application of pesticides with power equipment.

~~((a) Leave a 10 foot buffer strip on each side of every Type 1 and 2 Water and each flowing Type 3 Water.~~

~~(b) Do not allow entry of chemicals into any water.~~

~~(c) Do not exceed allowable dosages.))~~ Leave a 25-foot buffer strip on each side of Type A or B Wetlands and all typed waters, except segments of Type 4 and 5 Waters with no surface water.

~~\* (7) ((Stream protection=))~~ Hand application of pesticides.

~~. Apply only to specific targets, such as ((a stump, burrow, bait or trap))~~ vegetation, trees, stumps, and burrows, or as bait or in traps.

~~\* (8) Limitations on application. ((Chemicals))~~ Pesticides shall be applied only in accordance with all limitations:

(a) Printed on the United States Environmental Protection Agency container registration label, and/or

(b) Established by regulation of the state department of agriculture.

(c) Established by state and local health departments (in municipal watersheds).

(d) Established by the Federal Occupational Safety and Health Administration, or the state department of labor and industries, as they relate to safety and health of operating personnel and the public.

(e) The department or the department of agriculture may suspend further use of any equipment responsible for chemical leakage until the deficiency has been corrected to the satisfaction of the department suspending its usage.

~~\* (9) Container disposal. ((Chemical))~~ Pesticide containers shall be either:

(a) Removed from the forest and disposed of in the manner consistent with label directions; or

(b) Removed and cleaned for reuse in a manner ~~((not inconsistent))~~ consistent with any applicable regulations of the state department of agriculture or the state or local health departments.

\* (10) Daily records – aerial application of pesticides. On all aerial applications of pesticides, the operator shall maintain for 3 years daily records of spray operations as required by the state department of agriculture WAC 16-228-190.

\* (11) Reporting of spills. All potentially damaging chemical spills shall be immediately reported to the department of ecology. Emergency telephone numbers for reporting spills shall be available at the department's regional offices.

## NEW SECTION

WAC 222-38-030 HANDLING, STORAGE, AND APPLICATION OF FERTILIZERS. \* (1) Storage and loading areas. Storage and loading areas should be located where accidental spillage of fertilizers will not enter surface water or wetlands. If any fertilizer is spilled, immediate appropriate procedures shall be taken to contain it.

\* (2) Riparian management zone. Fertilizer treatments within a riparian management zone shall be by hand unless the department has approved a site specific plan with another method of treatment.

\* (3) Wetland management zone. Fertilizer treatments within a wetland management zone shall be by hand unless the department has approved a site specific plan with another method of treatment.

\* (4) Aerial application of fertilizer.

(a) Proposed fertilization units shall be planned to avoid and to minimize the direct or indirect introduction of fertilizer into waters and wetlands.

(b) Leave a 25 foot buffer on all Type 1, 2, and 3 Waters, except as noted in (f) of this subsection.

(c) When the helicopter flight path during fertilizer application is parallel to a water course or the WMZ edge, the centerline of the initial swath should be adjusted to prevent direct application within the buffers or WMZs.

(d) Leave at least a 200 foot buffer strip around residences and a 100 foot buffer strip adjacent to lands used for agriculture unless such residence or farmland is owned by the forest landowner or the aerial application is acceptable to the resident or landowner.

(e) The landowner shall identify for the operator the units to be fertilized and the untreated areas within the units with appropriately marked aerial photos or detailed planimetric maps. Before application of the fertilizer, an over-flight of the area shall be made by the pilot and with the marked photos or maps.

(f) Where the department has been provided information by the department of ecology indicating that water quality in downstream waters is likely to be impaired by entry of fertilizer into waters, such waters shall be protected by site specific conditioning.

\* (5) Ground and hand application of fertilizers. Prevent fertilizer from entering Type A and B Wetlands and all typed waters, except segments of Type 4 and 5 Waters with no surface water.



**\*(6) Reporting of fertilizer spills.** All fertilizer spills involving streams, lakes, wetlands, or other waters of the state shall be immediately reported to the department of ecology. Emergency telephone numbers for reporting spills shall be available at the department's regional offices.

### NEW SECTION

**WAC 222-38-040 HANDLING, STORAGE, AND APPLICATION OF OTHER FOREST CHEMICALS.** **\*(1) Waters and wetlands.** Do not allow direct entry of other forest chemicals into any typed waters, except segments of Type 4 and 5 Waters with no surface water, or Type A or B Wetlands.

**\*(2) Storage, mixing, and loading areas.**

(a) Mix other forest chemicals and clean tanks and equipment only where any accidental spills would not enter surface water or wetlands.

(b) Storage and loading areas should be located where accidental spillage of other forest chemicals will not enter surface water or wetlands. If any chemical is spilled, immediate appropriate procedures should be taken to contain it.

(c) Use devices or procedures to prevent "back siphoning" such as providing an air gap or reservoir between the water source and the mixing tank.

(d) Water protection requirements in subsection (1) of this section may be waived when emergency use of fire retardants is necessary to control wildfire.

### **WSR 92-15-012**

#### **NOTICE OF PUBLIC MEETINGS TRANSPORTATION IMPROVEMENT BOARD**

[Memorandum—July 2, 1992]

MEETING NOTICE FOR JULY 1992  
TRANSPORTATION IMPROVEMENT BOARD  
OLYMPIA, WASHINGTON 98504-0901

Work session, 7:00 p.m., Thursday, July 23, 1992, in Olympia at the Best Western Aladdin Motor Inn, Cascade Room.

Board meeting, 9:00 a.m., Friday, July 24, 1992, in Olympia at the Transportation Building, Commission Board Room.

No TIB meeting in August. The next scheduled meeting is September 25, 1992, in Everett, Washington.

### **WSR 92-15-013**

#### **COLUMBIA RIVER GORGE COMMISSION**

[Filed July 2, 1992, 4:22 p.m.]

**Reviser's note:** The following material has not been adopted under the Administrative Procedure Act, chapter 34.05 RCW, but has been filed in the office of the code reviser and is published in the Register exactly as filed.

#### **CERTIFICATE AND ORDER FOR FILING PERMANENT ADMINISTRATIVE RULES WITH THE OFFICE OF THE CODE REVISER**

I hereby certify that the copy shown below is a true, full and correct copy of permanent rule(s) adopted on June 23, 1992, by the Columbia River Gorge Commission to become effective upon filing.

The within matter having come before the Columbia River Gorge Commission after all procedures having been in the required form and conducted in accordance with applicable statutes and rules and being fully advised in the premises.

Notice of Intended Action in Code Reviser's Register: Yes.

Now therefore, it is hereby ordered that the following action to be taken: Adopted 350-50 as Administrative Rules of the Columbia River Gorge Commission.

Dated this 30th day of June, 1992.

Jonathan Doherty  
Executive Director

Statutory Authority: RCW 43.97.015 to 43.97.035, chapter 499, Laws of 1987.

For Further Information Contact: Jan Brending, Rules Coordinator, (509) 493-3323.

Summary: The rule sets out the procedures that must be followed in order for the commission to consider a plan amendment.

Statement of Need: The process for submitting a plan amendment is not described in the National Scenic Act; the commission, local government and public at large needs guidance as soon as possible on how to submit plan amendments; and a delay in adoption of the rule will hold up the process of the commission considering plan amendments.

Authority: 16 USC § 544 et seq., ORS 196.150 to ORS 196.165, and RCW 43.97.015 to 49.97.035 [43.97.035].

Documents Relied Upon: The Columbia River Gorge National Scenic Area final management plan and the National Scenic Area Act.

Fiscal Impact: The rule should expedite the plan amendment process and therefore, reduce costs.

COLUMBIA RIVER GORGE COMMISSION  
Chapter 350  
Division 50  
Plan Amendment Process

350-50-010. Purpose.

This division specifies the process that will be used by the Columbia River Gorge Commission (Commission) when it considers amendments to the Management Plan.

350-50-020. Authority.

Amendments to the Management Plan must comply with the requirements of the Scenic Area Act. These requirements are included in Section 6(h) of the Scenic Area Act:

(1) If the Commission determines at any time that conditions within the Scenic Area have significantly changed, it may amend the Management Plan.

(2) The Commission shall submit amendments to the Management Plan to the Secretary of Agriculture for

review, in accordance with the provisions of the Scenic Area Act for adoption of the Management Plan.

(3) The Commission shall adopt an amendment to the Management Plan by a majority vote of the members appointed, including at least three members from each state.

(4) An amendment to the Management Plan must be consistent with the standards established in Section 6 and the purposes of the Scenic Area Act.

#### 350-50-030. Criteria for Plan Amendment Approval.

The Commission must find that the following three criteria are satisfied before it approves an amendment of the Management Plan:

(1) Conditions in the Scenic Area have significantly changed. This means:

(a) physical changes that have widespread or major impacts to the landforms, resources, or land use patterns in the Scenic Area;

(b) new information or inventory data regarding land uses or resources that could result in a change of a plan designation, classification, or other plan provision; or

(c) changes in legal, social, or economic conditions, including those that affect public health, safety, or welfare, not anticipated in the Management Plan;

(2) No practicable alternative to the proposed amendment exists; and

(3) The proposed amendment would be consistent with the standards and purposes of the Scenic Area Act.

#### 350-50-040. Origin of Applications.

Applications to amend the Management Plan may originate from the Commission or interested persons, including state and local governments, Indian tribal governments, public interest groups, or affected landowners.

#### 350-50-050. Application for Plan Amendment.

Applications to amend the plan shall contain a statement from the sponsor that explains why the proposed plan amendment is needed. The statement shall demonstrate that the proposed amendment complies with the purposes and standards of the Scenic Area Act and the criterion in Section 6(h) of the Scenic Area Act.

#### 350-50-060. Processing of Application.

Each application for a plan amendment will be reviewed according to the provisions in the Management Plan [Part IV, Chapter 1, section Amendment of the Management Plan, Policy 2].

**Reviser's note:** The brackets and enclosed material in the text above occurred in the copy filed by the Columbia River Gorge Commission and appear in the Register pursuant to the requirements of RCW 34.08.040.

#### 350-50-070. Submittal and Acceptance of Application.

(1) Applications for plan amendments shall be submitted to the Commission office by a sponsor. An original and fifteen copies of the each application are required.

(2) Within ten (10) working days of receiving an application, the Executive Director shall review the application for completeness and adequacy. No application

shall be accepted as complete until all omissions and deficiencies noted by the Executive Director have been corrected by the applicant.

(3) The Executive Director shall recommend to the Commission whether to commence the process for review of the proposed amendment to the plan. A decision to commence the process must be based on a majority vote of the Commission at a regularly scheduled meeting.

#### 350-50-080. Notice of Application.

(1) Public notice of the completed application will be sent to U.S. Forest Service – National Scenic Area Office, States of Oregon and Washington, Indian tribal governments, and the six Gorge county planning offices.

(2) Notice shall be published in local Gorge newspapers serving the National Scenic Area.

(3) Copies of the complete application will be available for inspection at the Commission office during normal office hours.

(4) Interested persons shall have twenty (20) working days from the date the notice is posted to submit written comments to the Executive Director. Written comments should address whether the proposed amendment would be consistent with the purposes and standards of the Scenic Area Act and the criterion in Section 6(h) of the Scenic Area Act.

#### 350-50-090. Report of the Executive Director.

The Executive Director will prepare a report, which may include recommendations, within thirty (30) working days of the date an application has been accepted as complete. Upon application of the Executive Director, the Commission may extend the time for submission of the report. The report will analyze the proposed amendment based on the purposes and standards of the Scenic Area Act and the criterion in Section 6(h) of the Scenic Area Act.

#### 350-50-100. Hearings.

(1) The Commission will conduct a hearing on every application that the Commission has decided to review pursuant to 350-50-070(3).

(2) A hearing will be conducted on the merits of each application. This hearing will be quasi-judicial in nature and will allow the parties, including intervenors, to present the plan amendment in a format that follows the contested case rules of the Commission [see Chapter 350, Division 16]. Any person who submitted comments on a plan amendment application pursuant to 350-50-080(3) may participate in the hearing by filing a Notice of Intervention with the Director within twenty (20) working days of the date the Executive Director's report is prepared, pursuant to 350-50-090. The Notice of Intervention shall also be served by mail upon the applicable sponsor. The Notice of Intervention shall show that the person filing the Notice has submitted comments on the proposed plan amendment. The sponsor shall be afforded an opportunity for rebuttal argument.

(3) The Commission may seek additional information from any applicant before and during the hearing.

**Reviser's note:** The brackets and enclosed material in the text above occurred in the copy filed by the Columbia River Gorge Commission and appear in the Register pursuant to the requirements of RCW 34.08.040.

### 350-50-110. Consultation.

In considering an amendment to the Management Plan, the Gorge Commission shall consult with the Forest Service, both states, the six Gorge counties, all four Indian tribal governments and agencies or organizations that have a specific interest.

### 350-50-120. Review by the Secretary of Agriculture.

According to Sections 6(f) and 6(h) of the Scenic Area Act, an amendment to the Management Plan adopted by the Commission will be submitted to the Secretary of Agriculture. The Secretary of Agriculture will review the amendment and determine if it is consistent with the purposes and standards of the Scenic Area Act. The Secretary has 90 days from the day the Commission submits an amendment to complete his/her review and make a determination of concurrence or non-concurrence.

**WSR 92-15-014**  
**PERMANENT RULES**  
**WASHINGTON STATE PATROL**

[Filed July 6, 1992, 9:35 a.m.]

Date of Adoption: June 30, 1992.

Purpose: Address change and other housecleaning purposes.

Citation of Existing Rules Affected by this Order: Amending WAC 446-16-025, 446-16-030, 446-16-080, and 446-16-090.

Statutory Authority for Adoption: RCW 10.97.080 and 10.97.090.

Pursuant to notice filed as WSR 92-11-051 on May 19, 1992.

Effective Date of Rule: Thirty-one days after filing.

June 30, 1992  
George B. Tellevik  
Chief

### AMENDATORY SECTION (Amending Order 1, filed 2/11/74)

WAC 446-16-025 EXPUNGEMENT OF ARREST RECORDS. (1) A person desiring the destruction of his fingerprints and/or other identifying data, pursuant to RCW 43.43.730, shall make his request therefor on a form furnished by the Washington state patrol section on identification. The request shall be mailed or delivered to the central office of the section located at ((3330)) 3310 Capitol Boulevard, Tumwater, Washington.

(2) The request shall be completed, signed by the person whose record is sought to be expunged and his signature witnessed. It shall include the address of the

applicant, the printed name and the address of the witness to the applicant's signature and such other information requested on the application as identifies the applicant and the offense for which the request of expungement is made.

(3) The request shall include reasonable proof that the person making the request for expungement is the same person whose fingerprints or other identifying data are sought to be expunged. Such proof shall include fingerprints of the applicant if requested by the section.

(4) The request shall include reasonable proof that the person making the request has no prior criminal record and that he has been found not guilty of the offense for which the fingerprints and/or other identifying data were taken or was finally released without a conviction for such offense having been obtained or has other lawful grounds for expungement. Such proof shall include the furnishing of all details pertaining to the finding of not guilty or release without conviction of such criminal charges. Where the finding or release is based on an order of a court, the applicant shall furnish a certified or xeroxed copy of the court order.

### AMENDATORY SECTION (Amending Order 1, filed 2/11/74)

WAC 446-16-030 INSPECTION BY THE SUBJECT OF ((HHS)) THEIR RECORD((S)). (1) Any person desiring to inspect criminal offender record information which refers to ((himself)) themselves may do so at the central office of the Washington state identification section located at ((3330)) 3310 Capitol Boulevard, Tumwater, Washington, between the hours of 8 a.m. and 5 p.m., Monday through Friday, excepting legal holidays.

(2) Any person desiring to inspect criminal offender record information pertaining to ((himself)) themselves shall first permit ((his)) their fingerprints to be taken by the section for identification purposes if requested to do so. The section in their discretion may accept other identification in lieu of fingerprints.

(3) A reasonable period of time, not to exceed 15 minutes, shall be allowed each individual to examine criminal offender record information pertaining to themselves.

(4) No person shall be allowed to retain or reproduce any criminal offender record information pertaining to themselves except for the purpose of challenge or correction of entries of arrests by submitting law enforcement agencies of the state of Washington. Visual examination only shall be permitted of such information unless the individual asserts ((his)) their belief that criminal offender record information from a submitting law enforcement agency of the state of Washington concerning ((him)) them is inaccurate, incomplete or maintained in violation of the law; and unless ((he)) they request((s)) correction or completion of the information on a form furnished by the section, or requests expungement pursuant to WAC 446-16-025.

(5) If any person who desires to examine criminal offender record information pertaining to ((himself)) themselves is unable to read or is otherwise unable to examine same because of a physical disability, ((he)) they

may designate another person of ~~((his))~~ their own choice to assist ~~((him))~~ them. The person about whom the information pertains shall execute, with ~~((his))~~ their mark, a form provided by the section consenting to the inspection of criminal offender record information pertaining to ~~((himself))~~ themselves by another person for the purpose of it being read or otherwise described to ~~((him))~~ them. Such designated person shall then be permitted to read or otherwise describe or translate the criminal offender record information to the person about whom it pertains.

**AMENDATORY SECTION** (Amending Order 91-007, filed 11/1/91, effective 12/2/91)

WAC 446-16-080 REPORT TIME LIMITATIONS. All of the information requested on the disposition report shall be completed and the report mailed to the Washington State Identification Section, ~~((Mailstop QE-02))~~ PO Box 42633, Olympia, Washington 98504-2633, within 10 days of the date that a disposition becomes effective.

**AMENDATORY SECTION** (Amending Order 1, filed 2/11/74)

WAC 446-16-090 LAW ENFORCEMENT AGENCIES—REPORTING RESPONSIBILITIES.

(1) If the disposition of criminal charges is made by the arresting agency, as where the individual is released without charge, the arresting agency shall fill in and complete the disposition report and mail same to the section. If the disposition is known at the time and arrest record or fingerprint card is submitted to the section, this information should be noted thereon. In this case, it shall be unnecessary to forward a disposition report.

(2) In all cases where the arresting agency does not make the final disposition, it shall initiate the preparation of a disposition report by recording the name of the individual arrested, ~~((the designated fingerprints of the individual;))~~ the charges on which he was arrested, the name of the contributor of the arrest or fingerprint record, the arrest number and any other information that may identify the individual. At this stage the disposition of charges shall be left blank, but the agency shall note the action that it has taken, e.g., referred to the prosecutor, etc. The partially completed disposition report shall then be included as part of the individual's case file and shall be forwarded with other information concerning the charges against the individual to the prosecutor or other agency to which the arresting agency forwards the case.

**WSR 92-15-015**

**PERMANENT RULES**

**WASHINGTON STATE PATROL**

[Filed July 6, 1992, 9:37 a.m.]

Date of Adoption: June 30, 1992.

Purpose: To establish a fee of \$25.00 for fingerprint background checks and for miscellaneous housecleaning

changes. Also, a four-dollar processing fee has been added.

Citation of Existing Rules Affected by this Order: Amending WAC 446-20-285, 446-20-290, 446-20-300, 446-20-420, 446-20-440, and 446-20-520.

Statutory Authority for Adoption: RCW 43.43.760, 43.43.815, and 43.43.838.

Pursuant to notice filed as WSR 92-11-052 on May 19, 1992.

Changes Other than Editing from Proposed to Adopted Version: A four-dollar processing fee has been added to all fees charged.

Effective Date of Rule: Thirty-one days after filing.

June 30, 1992

George B. Tellevik  
Chief

**AMENDATORY SECTION** (Amending Order 91-004, filed 12/4/91, effective 1/4/92)

WAC 446-20-285 EMPLOYMENT—CONVICTION RECORDS—CHILD AND ADULT ABUSE INFORMATION. After January 1, 1988, certain child and adult abuse conviction information will be furnished by the state patrol upon the submission of a written request of any applicant, business or organization, the state board of education, or the department of social and health services. This information will consist of the following:

(1) Convictions of crimes against children or other persons as defined in RCW 43.43.830(6), and as amended by chapter 9A.44 RCW;

(2) Department of health disciplinary authority final decisions of specific findings of physical or sexual abuse or exploitation of a child and any subsequent criminal charges associated with the conduct that is the subject of the disciplinary authority final decision; for the businesses and professions defined in chapter ~~((3, Laws of 1990))~~ 9A.44 RCW; and

(3) Civil adjudications of child abuse, as amended by chapter 9A.44 RCW.

This information will be furnished, consistent with the provisions of RCW 43.43.830 through 43.43.840, on an approved request for criminal history information form available from the Washington State Patrol, Identification and Criminal History Section, ~~((Mailstop QE-02))~~ PO Box 42633, Olympia, Washington, 98504-2633.

School districts, the superintendent of public instruction, educational service districts and their contractors will also receive conviction information under RCW 10.97.030 and 10.97.050 pursuant to chapter 159, Laws of 1992.

The state patrol shall also furnish any similar records maintained by the Federal Bureau of Investigation or records in custody of the National Crime Information Center, if available, subject to their policies and procedures regarding such dissemination.

(a) The business or organization making such request shall not make an inquiry to the Washington state patrol or an equivalent inquiry to a federal law enforcement agency unless the business or organization has notified the applicant who has been offered a position as an employee or volunteer that an inquiry may be made.

(b) For positive identification, the request for criminal history information form may be accompanied by fingerprint cards of a type specified by the Washington state patrol identification section, and shall contain a certification by the business or organization; the state board of education; or the department of social and health services, that the information is being requested and will be used only for the purposes as enumerated in RCW 43.43.830 through 43.43.845.

(c) In the absence of fingerprint cards, the applicant may provide a right thumb fingerprint impression in the area provided on the request for criminal history information form. In the event of a possible match, where the applicant's name and date of birth as submitted varies from that of the record contained by the identification section, the right thumb fingerprint impression will be used for identification verification purposes only. An exact name and date of birth match will be required for dissemination of conviction information in the absence of a fingerprint card or thumbprint impression for positive identification or verification of record.

(d) After processing a properly completed request for criminal history information form, if the conviction record, disciplinary authority final decision, adjudication record, or equivalent response from a federal law enforcement agency shows no evidence of crimes against persons, an identification declaring the showing of no evidence shall be issued to the applicant by the state patrol within fourteen working days of receipt of the request. Possession of such identification shall satisfy future ((background)) record check requirements for the applicant for a two-year period.

(e) The business or organization shall notify the applicant of the state patrol's response within ten calendar days after receipt by the business or organization. The employer shall provide a copy of the response to the applicant and shall notify the applicant of such availability.

(f) The business or organization shall be immune from civil liability for failure to request background information on a prospective employee or volunteer unless the failure to do so constitutes gross negligence.

AMENDATORY SECTION (Amending Order 91-004, filed 12/4/91, effective 1/4/92)

WAC 446-20-290 FEES. (1) A nonrefundable fee of ten dollars shall accompany each request for conviction records submitted for a name and date of birth background check at the state level pursuant to RCW 43.43.815 and 43.43.830 through 43.43.845, and chapter 10.97 RCW, unless through prior arrangement an account is authorized and established.

(a) A nonrefundable fee of twenty-five dollars shall accompany each request for a background check submitted with a fingerprint card at the state level.

(b) In addition to the state search and fees, an FBI search is required for requests submitted under chapter 159, Laws of 1992. Two fingerprint cards are required to be mailed to the Identification Section at PO Box 42633, Olympia, Washington, 98504-2633. In addition to the fee for the state search, appropriate FBI fees will be charged.

(c) In addition, a four-dollar processing fee will be charged for each fingerprint background check processed under chapter 159, Laws of 1992.

All fees are to be made payable to the "Washington state patrol," and are to be remitted only by cashier's check, money order or check written on a commercial business account. The Washington state patrol identification section shall adjust the fee schedule as may be practicable to ensure that direct and indirect costs associated with the provisions of these chapters are recovered.

(2) Pursuant to provisions of RCW 43.43.838 and chapter 159, Laws of 1992, no fees will be charged to a nonprofit organization, ((including school districts and educational service districts, for the request for conviction records)) or school districts and educational service districts for name and date of birth background checks.

The superintendent of public instruction, school districts, educational service districts and their contractors shall pay the appropriate fees for state and national fingerprint checks conducted under chapter 159, Laws of 1992.

AMENDATORY SECTION (Amending Order 88-03-A, filed 3/17/88)

WAC 446-20-300 PRIVACY—SECURITY. (1) All employers or prospective employers receiving conviction records pursuant to RCW 43.43.815, shall comply with the provisions of WAC 446-20-210 through 446-20-250 relating to privacy and security of the records.

(2) Businesses or organizations, the state board of education, and the department of social and health services receiving conviction records of crimes against persons, disciplinary board final decision information, or a civil adjudication record pursuant to ((chapter 486, Laws of 1987)) RCW 43.43.815 and 43.43.830 through 43.43.845, shall comply with the provisions of WAC 446-20-220 (1) and (3) relating to privacy and security of the records.

(a) The business or organization shall use this record only in making the initial employment or engagement decision. Further dissemination or use of the record is prohibited. A business or organization violating this prohibition is subject to a civil action for damages.

(b) No employee of the state, employee of a business or organization, or the organization is liable for defamation, invasion of privacy, negligence, or any other claim in connection with any lawful dissemination of information under RCW 43.43.830 through 43.43.840 or 43.43.760.

AMENDATORY SECTION (Amending Order 80-2, filed 7/1/80)

WAC 446-20-420 MODEL AGREEMENT FOR RESEARCH, EVALUATIVE OR STATISTICAL PURPOSES.

AGREEMENT made this . . . . . day of . . . . ., ((+198-)) 199., between . . . . ., (hereinafter referred to as "RESEARCHER") and . . . . ., (hereinafter referred to as "CRIMINAL JUSTICE AGENCY")\*

WHEREAS the RESEARCHER has made a written request to the CRIMINAL JUSTICE AGENCY dated . . . . ., a copy of which is annexed hereto and made a part hereof, and

WHEREAS the CRIMINAL JUSTICE AGENCY has reviewed said written request and determined that it clearly specifies (1) the criminal history record information sought, and (2) the research, evaluative or statistical purpose for which the said information is sought,\*\* and

WHEREAS the RESEARCHER represents that (he) (she) (it) is in receipt of, and is familiar with, the provisions of chapter 10.97 RCW, 28 CFR Part 22, including provisions for sanctions at Parts 22.24(c) and 22.29 thereof,

NOW, THEREFORE, IT IS AGREED AS FOLLOWS:

1. The CRIMINAL JUSTICE AGENCY will supply the following items of information to the RESEARCHER:

(Describe in detail)\*\*\*

.....  
.....  
.....  
.....

2. The RESEARCHER will:

- (a) Use the said information only for the research, evaluative, or statistical purposes described in the above mentioned written request dated . . . . ., and for no other purpose;
- (b) Limit access to said information to the RESEARCHER and those of the RESEARCHER's employees whose responsibilities cannot be accomplished without such access, and who have been advised of, and agreed to comply with, the provisions of this agreement, and of 28 CFR Part 22;\*\*\*\*
- (c) Store all said information received pursuant to this agreement in secure, locked containers;
- (d) So far as possible, replace the name and address of any record subject with an alphanumeric or other appropriate code;
- (e) Immediately notify the CRIMINAL JUSTICE AGENCY in writing of any proposed material changes in the purposes or objectives of its research, or in the manner in which said information will be used.

3. The RESEARCHER will not:

- (a) Disclose any of the said information in a form which is identifiable to an individual, in any project report or in any manner whatsoever, except pursuant to 28 CFR Part 22.24 (b)(1)(2).
- (b) Make copies of any of the said information, except as clearly necessary for use by employees or contractors to accomplish the purposes of the research. (To the extent reasonably possible, copies shall not be made of criminal history record information, but information derived therefrom which is not identifiable to specific individuals shall be

used for research tasks. Where this is not possible, every reasonable effort shall be made to utilize coded identification data as an alternative to names when producing copies of criminal history record information for working purposes.)

- (c) Utilize any of the said information for purposes or objectives or in a manner subject to the requirement for notice set forth in 2.(e) until specific written authorization therefor is received from the CRIMINAL JUSTICE AGENCY.

4. In the event the RESEARCHER deems it necessary, for the purposes of the research, to disclose said information to any subcontractor, (he) (she) (it) shall secure the written agreement of said subcontractor to comply with all the terms of this agreement as if (he) (she) (it) were the RESEARCHER named herein.\*\*\*\*

5. The RESEARCHER further agrees that:

- (a) The CRIMINAL JUSTICE AGENCY shall have the right, at any time, to monitor, audit, and review the activities and policies of the RESEARCHER or its subcontractors in implementing this agreement in order to assure compliance therewith; and
- (b) Upon completion, termination or suspension of the researcher, it will return all said information, and any copies thereof made by the RESEARCHER, to the CRIMINAL JUSTICE AGENCY, unless the CRIMINAL JUSTICE AGENCY gives its written consent to destruction, obliteration or other alternative disposition.

6. In the event the RESEARCHER fails to comply with any term of this Agreement the CRIMINAL JUSTICE AGENCY shall have the right to take such action as it deems appropriate, including termination of this Agreement. If the CRIMINAL JUSTICE AGENCY so terminates this Agreement, the RESEARCHER and any subcontractors shall forthwith return all the said information, and all copies made thereof, to the CRIMINAL JUSTICE AGENCY or make such alternative disposition thereof, as is directed by the CRIMINAL JUSTICE AGENCY. The exercise of remedies pursuant to this paragraph shall be in addition to all sanctions provided by law, and to legal remedies available to parties injured by disclosures.

7. INDEMNIFICATION. The RESEARCHER agrees to indemnify and hold harmless (CRIMINAL JUSTICE AGENCY) and its officers, agents and employees from and against any and all loss, damages, injury, liability suits and proceedings however caused, arising directly or indirectly out of any action or conduct of the (RESEARCHER) in the exercise or enjoyment

of this agreement. Such indemnification shall include all costs of defending any such suit, including attorney fees.

IN WITNESS WHEREOF the parties have signed their names hereto this . . . . day of . . . . ., ((+198--)) 199...

.....(CRIMINAL JUSTICE AGENCY)

by ..... (Name)

Title: .....

.....(RESEARCHERS)

by ..... (Name)

Title: .....

COMPLIANCE AGREEMENT of employee, consultant or subcontractor.

(I) (We), employee(s) of, consultant to, (and) (or) subcontractor of the RESEARCHER, acknowledge familiarity with the terms and conditions of the foregoing agreement between the CRIMINAL JUSTICE AGENCY and RESEARCHER, and agree to comply with the terms and conditions thereof in (my) (our) use and protection of the criminal history record information obtained pursuant to the foregoing agreement.

..... (date) ..... (signature)

..... (date) ..... (signature)

AMENDATORY SECTION (Amending Order 80-2, filed 7/1/80)

WAC 446-20-440 CONTRACT FOR SUPPORT SERVICES MODEL AGREEMENT UNDER WAC 446-20-180. (Some provisions may not be applicable in all cases and are noted accordingly.)

I. General Provisions

A. Parties: This agreement is made and entered into this . . . . day of . . . . ., ((+198--)) 199., by and between ( (head of agency) ), Administrator of ( (criminal justice agency) ) and ( (head of agency) ) of (Support Services Agency of "User").

B. Purpose of Agreement: This agreement authorizes (user) to collect, retrieve, maintain and/or disseminate criminal history record information (hereinafter, CHRI) pursuant to RCW 10.97.050(5), WAC 446-20-180, and the terms of this contract. In addition, it provides for the security and privacy of information in that dissemination to criminal justice agencies shall be limited for the purposes of the administration of justice and

criminal justice agency employment. Dissemination to other individuals and agencies shall be limited to those individuals and agencies authorized by either the Washington state patrol, under chapter 10.97 RCW or local ordinance, as specified by the terms of this contract, and shall be limited to the purposes for which it was given and may not be disseminated further.

II. Duties of Criminal Justice Agency

A. In accordance with federal and state regulations, (criminal justice agency) agrees to furnish complete and accurate criminal history information to user, pursuant to RCW 10.97.040.

B. (Criminal justice agency) shall specify and approve those individuals or agencies authorized to obtain CHRI, which includes non-conviction data, pursuant to RCW 10.97.050(4) or by local ordinance.

III. Duties of User

A. (User) will collect, retrieve, maintain and/or disseminate all information covered by the terms of this agreement in strict compliance with all present and future federal and state laws and regulations. In addition, all programs, tapes, source documents, listings, and other developmental or related data processing information containing or permitting any person to gain access to CHRI and all personnel involved in the development, maintenance, or operation of an automated information system containing CHRI are subject to the requirements of RCW 10.97.050(5) and WAC 446-20-180.

B. (User) will obtain the assistance of the (criminal justice agency) to familiarize its personnel with and fully adhere to section 524(b) of the Crime Control Act 1973 (42 USC 3771(b)), 28 CFR Part 20, chapter 10.97 RCW and chapter 446-20 WAC, promulgated by the Washington state patrol.

C. (User) will disseminate CHRI only as authorized by chapter 10.97 RCW and as specified by (criminal justice agency) in this agreement.

D. (User) agrees to fully comply with all rules and regulations promulgated by the Washington state patrol, pursuant to RCW 10.97.090(2), regarding standards for the physical security, protection against unauthorized access and personnel procedures and safeguards.

E. (User) agrees to permit access to its records system for the purposes of an audit, as specified under RCW 10.97.090(3).



IV. Suspension of Service

(Criminal justice agency) reserves the right to immediately suspend furnishing information covered by the terms of this agreement to (User), when any terms of this agreement are violated. (Criminal justice agency) shall resume furnishing information upon receipt of satisfactory assurances that such violations have been fully corrected or eliminated.

V. Cancellation

Either (criminal justice agency) or (user) may cancel this agreement upon thirty days notice to the other party.

VI. Indemnification

User hereby agrees to indemnify and hold harmless (criminal justice agency) and its officers, agents and employees from and against any and all loss, damages, injury, liability suits and proceedings however caused, arising directly or indirectly out of any action or conduct of the (user) in the exercise or enjoyment of this agreement. Such indemnification shall include all costs of defending any suit, including attorney fees.

VII. Construction

This agreement shall be liberally construed to apply to both manual and automated information systems wherever and whenever possible.

(CRIMINAL JUSTICE AGENCY) (USER)

By: ..... By: .....
Title: ..... Title: .....
Date: ..... Date: .....

AMENDATORY SECTION (Amending Order 90-003, filed 9/20/90, effective 10/21/90)

WAC 446-20-520 PHOTOGRAPHS. Photographs should be of the polaroid type and in color. These are not to be file photos. A new photo is required.

On the reverse side of the photo, write full name, date of birth, and SID number. Paperclip (no staples please) the photo to the fingerprint card with the registration information completed and forward to Washington State Patrol, Identification and Criminal History Section, ((Mailstop QE-02)) PO Box 42633, Olympia, WA 98504-2633.

WSR 92-15-016
ATTORNEY GENERAL OPINION
Cite as: AGO 1992 No. 13
[June 30, 1992]

WASHINGTON CITIZENS' COMMISSION ON SALARY FOR ELECTED OFFICIALS—COURTS—JUDGES—SALARIES AND WAGES—COUNTIES—CONSTITUTIONAL AMENDMENTS—

ELECTIONS—APPLICABILITY OF AMENDMENT 78 TO PART-TIME DISTRICT COURT JUDGES AND QUALIFICATIONS FOR NONATTORNEY TO BE ELECTED DISTRICT COURT JUDGE

- 1. Article 28 of the Washington Constitution (Amendment 78) provides that an independent salary commission shall set the salary for district court judges. With regard to part-time district court judges, the commission has set the salary based on the proportion of full-time work for which the part-time judge is authorized. The county legislative authority determines the proportion of work for which the part-time district court judge is authorized.
2. Prior to 1991 the commission had not established a salary for part-time district court judges. Amendment 78 provides that salaries in effect in 1987 shall remain in effect until changed by the commission. Thus, part-time district court judge salaries were set pursuant to RCW 3.58.020 until 1991 when the commission changed the salary. At that time, the salaries were properly set by the commission.
3. RCW 3.46.060 provides that a nonattorney can seek election as a district court judge under certain circumstances. A nonattorney district court judge can seek reelection if he or she is a registered voter of the district court district, and has been elected and has served as a district court judge. A nonattorney district court judge with these two qualifications can seek reelection even if the population of the district is between 5,000 and 10,000.

Requested by:

Honorable Dennis W. Morgan
Adams County Prosecuting Attorney
120 West Main Avenue
Ritzville, Washington 99169

WSR 92-15-017
NOTICE OF PUBLIC MEETINGS
PUGET SOUND
WATER QUALITY AUTHORITY
[Memorandum—July 2, 1992]

Listed below are the dates and locations for the regular meetings of the Puget Sound Water Quality Authority through December 1992. The locations for meetings through December 1993, have been confirmed and are included; I will continue to update you as we book facilities.

The meetings generally start at 9:30 a.m., any variation from this starting time will result in a starting time later than 9:30 a.m. Persons interested in more information about the meetings are invited to call Duane Fagergren at 493-9306 (in Lacey) or 1-800-SOUND.

July 15, 1992 Coupeville Coupeville Methodist Church
608 North Main
Coupeville, WA

August 19, 1992	Mercer Island	King County Library Mercer Island Branch Meeting Room 4400 88th S.E. Mercer Island, WA
September 16, 1992	Bremerton	Cascade Natural Gas 6313 Kitsap Way Bremerton, WA
October 21, 1992	Seattle	Port of Seattle Commission Chambers 2201 Alaskan Way, Pier 66 Seattle, WA
November 18, 1992	Everett	Snohomish County Courthouse 3000 Rockefeller Avenue Everett, WA
December 16, 1992	Tacoma	Port of Tacoma Commission Board Room 1 Sitcum Plaza World Trade Center 3600 Port of Tacoma Road Tacoma, WA

The following meeting facilities have not yet been booked:

January 20, 1993	Seattle
February 17, 1993	Shelton
March 17, 1993	Olympia
April 21, 1993	Mt. Vernon
May 19, 1993	Olympia
June 9, 1993	Seattle
July 21, 1993	Friday Harbor
August 18, 1993	Federal Way
September 15, 1993	Puyallup
October 20, 1993	Port Angeles
November 17, 1993	Kirkland
December 15, 1993	Seattle

**WSR 92-15-018**  
**PERMANENT RULES**  
**LAW REVISION COMMISSION**  
 [Filed July 6, 1992, 9:42 a.m.]

Date of Adoption: June 26, 1992.

Purpose: Provide basic information about the commission's organization, operation, and sources of information.

Statutory Authority for Adoption: RCW 1.30.050.

Pursuant to notice filed as WSR 92-11-064 on May 19, 1992.

Effective Date of Rule: Thirty-one days after filing.

June 29, 1992  
 Marjorie D. Rombauer  
 Chairperson

Chapter 306-01 WAC  
 WASHINGTON STATE LAW REVISION  
 COMMISSION

WAC	
306-01-010	Purpose
306-01-020	Membership
306-01-030	Officers
306-01-040	Meetings
306-01-050	Public Records
306-01-060	Law Revision Commission Research Projects
306-01-070	Reports to the Legislature
306-01-080	Coordination of Commission Activities

**[NEW SECTION]**

**WAC 306-01-010 PURPOSE AND DUTIES.** The Law Revision Commission is established pursuant to Chapter 1.30 RCW. The purpose of the Law Revision Commission is to: (1) provide facilities and procedures to undertake the scholarly investigation of the law; (2) recommend to the Legislature elimination of antiquated and inequitable rules of law and removal of other defects or anachronisms in the law; and (3) encourage the clarification and simplification of the law in Washington and to promote its better adaptation to modern conditions. The specific duties of the Commission are set forth in RCW 1.30.040.

**Reviser's note:** The bracketed material preceding the section above was supplied by the code reviser's office.

**[NEW SECTION]**

**WAC 306-01-020 MEMBERSHIP.** The Law Revision Commission consists of 13 members as follows:

- (1) Two senators, ex officio, designated by the President of the Senate, and not members of the same political party;
- (2) Two representatives, ex officio, designated by the Speaker of the House of Representatives, and not members of the same political party;
- (3) Three deans of accredited law schools of the State, ex officio, or their designees from members of their respective law faculties;
- (4) Four lawyers admitted to practice in the State, designated by the Board of Governors of the Washington State Bar Association;
- (5) Two non-lawyer members with a demonstrated interest in the work of the Law Revision Commission, appointed by the Governor.

**Reviser's note:** The bracketed material preceding the section above was supplied by the code reviser's office.

**[NEW SECTION]**

**WAC 306-01-030 OFFICERS.** There shall be a chair, a vice-chair, and a secretary of the Law Revision Commission, each elected by majority vote of the members. The officers shall serve at the pleasure of the Commission.

**Reviser's note:** The bracketed material preceding the section above was supplied by the code reviser's office.

**[NEW SECTION]**

**WAC 306-01-040 MEETINGS.** (1) The Law Revision Commission shall hold its regular meetings on the last Friday of March, of June, and of September, and the first Friday of December of each year. If at any time any regular meeting falls on a holiday, such regular meeting shall be held on the next business day. The Law Revision Commission may hold other meetings from time to time when called by the chair or when requested by five members of the Commission.

(2) Five members of the Commission shall constitute a quorum for the transaction of business.

(3) All meetings of the Commission shall be open to the public. Members of the public who wish to attend meetings held by conference phone call may attend by appearing at any one of the locations where members of

the Commission convene for such conference phone call meeting. Any member of the public may learn of the locations of such conference phone call meeting places by contacting the Secretary of the Commission.

(4) Meetings of the Commission shall be held in accordance with Roberts' Rules of Order, current revised edition, whenever requested by any member of the Commission.

**Reviser's note:** The bracketed material preceding the section above was supplied by the code reviser's office.

**[NEW SECTION]**

**WAC 306-01-050 PUBLIC RECORDS.** (1) All public records of the Law Revision Commission, including minutes, shall be available unless exempt from disclosure under Chapters 41.17 or 42.30 RCW. Any member of the public may examine records of the Commission by directing a request to the Secretary. The Secretary shall determine charges for copying Commission records for a requesting member of the public, at a charge not to exceed the actual cost of reproduction.

(2) Copies of the minutes, reports, and certain other records of the Law Revision Commission shall be on file at the University of Washington School of Law. Requests for examination of the materials located at the School of Law may be addressed to the Dean, University of Washington School of Law, Condon Hall, Seattle, Washington, 98105, with a copy of such request to the Secretary of the Commission.

**Reviser's note:** The bracketed material preceding the section above was supplied by the code reviser's office.

**[NEW SECTION]**

**WAC 306-01-060 LAW REVISION COMMISSION RESEARCH PROJECTS.** (1) Any Commissioner, state official, or any member of the public may suggest topics for study and recommendation by the Commission by directing a request to the chair or the secretary.

(2) The Commission may at its discretion choose topics for study and recommendation.

(3) The Commission may refer topics for study to subcommittees composed of members. These subcommittees may consult with other organizations or individuals and report their findings to the Commission.

(4) The Commission will circulate final drafts of its reports and recommendations to any persons who have requested copies of such drafts in a specific subject area, before making recommendation to the Legislature.

**Reviser's note:** The bracketed material preceding the section above was supplied by the code reviser's office.

**[NEW SECTION]**

**WAC 306-01-070 REPORTS TO THE LEGISLATURE.** The Commission shall report on its proceedings annually to the Legislature, on or before January 15 of each year, and, if the Commission deems advisable, accompany its report with proposed legislation to carry out any of its recommendations. The Law Revision Commission may transmit any other reports and recommended legislation to the Legislature at any other time.

**Reviser's note:** The bracketed material preceding the section above was supplied by the code reviser's office.

**[NEW SECTION]**

**WAC 306-01-080 COORDINATION OF COMMISSION ACTIVITIES.** The Commission shall confer and coordinate its activities with any committees of the Legislature, the State Bar Association, the Uniform Law Commission, the Statute Law Committee, or the Judicial Council in a manner as the Law Revision Commission finds will most efficiently accomplish its purposes and carry out its duties.

**Reviser's note:** The bracketed material preceding the section above was supplied by the code reviser's office.

**WSR 92-15-019  
NOTICE OF PUBLIC MEETINGS  
DEPARTMENT OF  
NATURAL RESOURCES  
[Memorandum—June 30, 1992]**

The Board of Natural Resources will hold a special meeting at 9:30 a.m., Friday, July 31, 1992, by conference call. The call will originate in Commissioner Brian Boyle's Office, 201 Cherberg Building, Olympia, Washington.

**WSR 92-15-020  
NOTICE OF PUBLIC MEETINGS  
BELLINGHAM TECHNICAL COLLEGE  
[Memorandum—July 6, 1992]**

The board of trustees of Bellingham Technical College will not meet in a regularly scheduled meeting in July. The next board of trustees meeting will be August 20, 1992.

**WSR 92-15-021  
PERMANENT RULES  
DEPARTMENT OF LICENSING  
[Filed July 6, 1992, 4:29 p.m.]**

Date of Adoption: July 1, 1992.

Purpose: Permit acceptance of bills of sale as evidence of ownership when applying for snowmobile registration; administrative clarification of snowmobile nonresident conditions; and prescribing day to day registration.

Citation of Existing Rules Affected by this Order: Amending WAC 308-94-030, 308-94-080, and 308-94-200.

Statutory Authority for Adoption: RCW 46.01.110.

Pursuant to notice filed as WSR 92-11-049 on May 19, 1992.

Effective Date of Rule: Thirty-one days after filing.

July 6, 1992  
Mary Riveland  
Licensing Director

AMENDATORY SECTION (Amending Order TL/RG 29, filed 1/16/87)

WAC 308-94-030 APPLICATION FOR REGISTRATION. An application for registration of a snowmobile shall include:

- (1) Name and address of registered owner(s);
- (2) Make and model year of snowmobile;
- (3) Method of propulsion, including but not limited to skis, tracks, wheels or combination thereof;
- (4) Purchase price and year of purchase or declared value and year of declaration;
- (5) Proof of payment of sales tax or a bill of sale establishing the price paid for the vehicle;
- (6) The previously issued registration certificate(;) or a duplicate thereof, or a bill of sale if the application is for the transfer of a registered snowmobile. If the snowmobile has not been previously registered in this state, a bill of sale or a purchase agreement shall be provided;
- (7) Vehicle identification number; and
- (8) Appropriate fees.

AMENDATORY SECTION (Amending Order TL/RG 29, filed 1/16/87)

WAC 308-94-080 NONRESIDENT TEMPORARY SNOWMOBILE PERMIT. An application for a nonresident temporary permit shall include:

- (1) Name and address of the applicant;
- (2) Plate or registration number if registered in another ((state)) jurisdiction;
- (3) Make and year of vehicle;
- (4) Vehicle identification number;
- (5) Method of propulsion, including but not limited to skis, tracks, wheels, or combination thereof;
- (6) Appropriate fees; and
- (7) Expiration date of the foreign ((state)) registration if registered in another jurisdiction.

AMENDATORY SECTION (Amending Order TL/RG 29, filed 1/16/87)

WAC 308-94-200 OFF-ROAD AND NON-HIGHWAY VEHICLE USE PERMIT PERIOD. (1) The registration year of off-road and nonhighway annual use permits will commence ((with) on the ((first)) day ((of the calendar month in which)) the off-road and nonhighway permit is first applied for, and end the ((last) same day ((of the preceding month)) of the following calendar year(, except that permits first applied for in January will end December 31 of the same calendar year)).

(2) Subsequent renewals of the off-road and nonhighway annual use permit will retain the registration ((year) month and day first established, provided that if a new owner applies for an off-road or nonhighway annual use permit at time of applying for transfer of title, and the off-road and nonhighway permit ((has been)) is expired ((for more than thirty days)), a new registration ((year may)) date will be established. ((Also;)) If an off-road and nonhighway vehicle has not been licensed as an off-road and nonhighway vehicle for the registration year immediately preceding the registration year in

which the application for off-road and nonhighway annual use permit is being made, or when the vehicle has been registered in another jurisdiction subsequent to any prior off-road and nonhighway registration in Washington, a new registration year may be assigned. There is no abatement of the off-road and nonhighway annual use permit fee.

(3) An owner desiring to continue operating an off-road and nonhighway vehicle shall renew the nonhighway annual use permit and display the validating tab no later than the first day of the ((month immediately following the month of expiration of the previously issued validating tab)) new registration year, or shall in lieu thereof purchase and display a temporary use permit valid for sixty days.

## WSR 92-15-022

PERMANENT RULES  
DEPARTMENT OF LICENSING

[Filed July 6, 1992, 4:39 p.m.]

Date of Adoption: July 1, 1992.

Purpose: Amend method for reporting a destroyed vehicle and describing rebuilt on the vehicle title.

Citation of Existing Rules Affected by this Order: Amending WAC 308-58-020 and 308-58-040.

Statutory Authority for Adoption: RCW 46.01.110.

Pursuant to notice filed as WSR 92-11-047 on May 19, 1992.

Effective Date of Rule: Thirty-one days after filing.

July 6, 1992

Mary Riveland

Licensing Director

AMENDATORY SECTION (Amending WSR 91-04-025, filed 1/29/91, effective 3/1/91)

WAC 308-58-020 METHOD OF REPORTING DESTRUCTION. (1) An insurance company settling a claim for a destroyed vehicle will report such settlement by using one of the following two methods:

(a) If the title is in the insurer's possession, the title will be forwarded to the department within fifteen days of the settlement. The insurer will type or print on the title, the name and address of the insurer, a notation "DESTROYED" or, in the event the vehicle is a total loss under the definitions contained in WAC 308-58-010, but in the opinion of the insurer may be repaired at a cost not to exceed sixty percent of its fair market value if repaired, a notation "TOTAL COST OF REPAIR LESS THAN SIXTY PERCENT," and the approximate date of destruction. The requested information will be placed on the title in such a manner as not to obscure any of the printed matter on the title itself. The title, with the information thereon, will be mailed to the ((Vehicle Records Section)) Technical Services Unit, Department of Licensing, PO BOX 9042, Olympia, ((Washington 98504)) WA 98507-9042.

(b) If the destroyed vehicle and its title do not come into the insurer's possession, the insurer will report the fact of settlement within fifteen days of settlement on a

form to be supplied by the department. The report will include the following information:

- (i) Year, make, series and body style of vehicle;
- (ii) License plate number, last year of registration and name of state in which registered;
- (iii) Registered and legal owner's name and address, if known;
- (iv) Cause of damage;
- (v) If the vehicle is repairable (A vehicle should be considered repairable only if its cost of repair would not exceed sixty percent of its fair market value if repaired.);
- (vi) Date and amount of sale;
- (vii) Name and address of the purchaser and if the purchaser is the assured, a private party, a salvage buyer, or a motor vehicle wrecker;
- (viii) Name and address of insurance company or adjuster;
- (ix) Date of report.

(2) Any private party, government agency, or self-insured person shall, upon destruction of a vehicle registered in their name, forward the title to the department within fifteen days of the destruction of the vehicle. The title must be endorsed by the legal owner to release their interest, if the legal owner is not the same as the registered owner. The registered owner will print or type on the title the word "DESTROYED," the approximate date of destruction and sign the title. ~~((The license plates from the vehicle will be surrendered to any office of the department of licensing.))~~

The title for a vehicle that has been destroyed, which title has not been surrendered to the department, shall be cancelled. Notice of this cancellation will be mailed to the legal owner of the vehicle by regular mail to the address as shown in the department's vehicle records. The legal owner will promptly return the cancelled title to the department.

#### AMENDATORY SECTION (Amending Order MV 142, filed 8/28/72)

WAC 308-58-040 DESTROYED VEHICLES REBUILT. ((An application for title to a destroyed)) Certificates of ownership and registration reissued for a vehicle reported destroyed that is less than four years old ((that has been repaired)) will contain the word "REBUILT" ((just above the applicable series and body type in the space reserved on the application for series and body type)) in an appropriate location on the certificate of ownership and the certificate of registration. This description will continue to appear on every subsequent certificate issued by the department for this vehicle.

The application for certificate of ownership of the vehicle will be accompanied by a bill of sale ((for the vehicle, passing)) transferring ownership to the applicant ((for title)) and a Washington state patrol inspection if the vehicle is to be operated in Washington as provided in WAC 308-56A-460. ((The application must also be accompanied by a signed statement confirming that the vehicle's identification number is the same as that shown on the application for title. This statement must be signed by someone authorized by the director of motor vehicles to confirm vehicle identification numbers. The

~~former license plate cannot be transferred. An original license plate must be purchased.~~

~~When the new title is prepared by the department, the title and registration will contain the word "REBUILT" in an appropriate location on each certificate. This identification will continue to appear on every certificate issued by the department for this vehicle whenever it is licensed or titled in Washington.~~

~~The requirements of this section shall not be applicable to a vehicle for which the cost of repair does not exceed sixty percent of the fair market value of the vehicle, if repaired, as determined by the insurance company report or title.))~~

#### WSR 92-15-023

#### PERMANENT RULES

#### DEPARTMENT OF LICENSING

[Filed July 6, 1992, 4:41 p.m.]

Date of Adoption: July 1, 1992.

Purpose: Adopt rules for confidential vessel registration program.

Statutory Authority for Adoption: RCW 88.02.035(3).

Pursuant to notice filed as WSR 92-11-046 on May 19, 1992.

Effective Date of Rule: Thirty-one days after filing.

July 6, 1992

Mary Riveland

Licensing Director

#### NEW SECTION

#### WAC 308-93-241 CONFIDENTIAL VESSEL REGISTRATION—APPLICATION PROCEDURES.

(1) Requests for confidential vessel registration shall be in writing, addressed to the administrator, title and registration services, department of licensing, Olympia, Washington and shall be accompanied by the following:

(a) An application for confidential vessel registrations, on a form furnished by the department;

(b) An explanation in support of the request for confidential vessel registrations, on a form furnished by the department, setting the purposes for which the vessel registration will be used, and why confidential vessel registrations are necessary to accomplish this purpose;

(c) Copies of documents establishing that the vessel is owned or controlled by the agency requesting issuance of confidential vessel registrations; acceptable documents include, but are not limited to, current certificate of title or registration, manufacturer's statement of origin, court order or seizure documents;

(d) Such other documentation as the department at its own discretion may reasonably require.

(2) The request, application, and explanation shall be signed by the agency head or designated contact person.

#### NEW SECTION

WAC 308-93-242 CONFIDENTIAL VESSEL REGISTRATION—AGENCY CONTACT. (1) Except as provided in subsection (2) of this section, the only

person authorized to request issuance of confidential vessel registrations or sign correspondence pertaining to the confidential vessel registration program, is the agency head, which shall include regional federal agency administrators and military commanding officers.

(2) The agency head may designate a maximum of two additional individuals within the agency as contact persons authorized to sign applications and correspondence pertaining to the confidential vessel registration program.

(3) The agency head must submit information to the department of licensing, on a form provided by the department, indicating the name, title, address, and telephone number of each additional contact person.

(4) Upon removal or replacement of an agency head or designated contact person, the department of licensing shall be notified in writing within five days of the change, and a new form as indicated in subsection (3) of this section shall be forwarded to the department.

#### NEW SECTION

WAC 308-93-243 CONFIDENTIAL VESSEL REGISTRATIONS—ANNUAL INVENTORY. By May 31 of each year, each agency having confidential vessel registrations in its possession shall furnish an inventory of the confidential vessel registrations to the department. The inventory shall include:

(1) A list of confidential vessel registrations;

(2) The make, year of manufacture, and identification number of each vessel bearing confidential vessel registrations;

(3) A certification, signed by the agency head or designated contact person, that all vessel registrations issued to the agency are being utilized solely for those purposes specified by RCW 88.02.035.

#### NEW SECTION

WAC 308-93-244 CONFIDENTIAL VESSEL REGISTRATIONS—REFUSAL. (1) The department of licensing may cancel or refuse to issue or reissue a confidential vessel registration when it has reason to believe the registration is being used for purposes not authorized in RCW 88.02.035. Issuance of the registration would violate the intent or meaning of the referenced statute.

(2) When an agency no longer requires a confidential vessel registration or the registration is canceled, the validation decal must be removed and destroyed and the confidential registration returned to the department of licensing for deletion from the agency's inventory.

#### NEW SECTION

WAC 308-93-245 CONFIDENTIAL VESSEL REGISTRATIONS—RECORDS DISCLOSURE. (1) In accordance with RCW 42.17.310(2), files, records, documents, and any other information pertaining to the confidential vessel registration program shall be exempt from public inspection and copying, as such disclosure would be contrary to vital government interests.

(2) Information concerning the confidential vessel registrations issued to any particular agency shall not be

released, except to the agency head or the designated contact person(s).

(3) Nothing herein shall be construed to prohibit the disclosure of statistical information which is not descriptive of the identity of the confidential vessel or its usage.

**WSR 92-15-024**  
**PERMANENT RULES**  
**DEPARTMENT OF LICENSING**  
[Filed July 6, 1992, 4:44 p.m.]

Date of Adoption: July 1, 1992.

Purpose: WAC 308-57-230, clarification to the abatement of license fee and excise taxes to be paid when registering a fleet vehicle for the first time; WAC 308-56A-010, authorizes the issuance of title purpose only documents for travel trailers and campers; WAC 308-56A-040 Form required for name and address—Address, delete the requirement for registered owners to provide the school district number when requesting a change of address. Clarification of address; WAC 308-56A-250 Signature of registered owner on application—Exceptions, authorize the addition of lienholder's without the signature of the registered owners under certain conditions; WAC 308-56A-260 Signature of legal owner on application, repeal of the requirement for lienholder to sign an application for title showing them as legal owner; WAC 308-56A-450 Glider kits, delete an assessors appraisal to establish the value for glider kits; WAC 308-56A-455 Assembled and homemade vehicles, delete an assessors appraisal to establish the value for homemade vehicles; WAC 308-56A-460 Destroyed vehicle rebuilt, describes the conditions under which a destroyed vehicle may be rebuilt and titled by a vehicle dealer. Retention of license plates; and WAC 308-56A-465 Fleets, revision to application for fleet identification.

Citation of Existing Rules Affected by this Order: Repealing WAC 308-56A-260; and amending WAC 308-57-230, 308-56A-010, 308-56A-040, 308-56A-250, 308-56A-450, 308-56A-455, 308-56A-460, and 308-56A-465.

Statutory Authority for Adoption: RCW 46.01.110.

Pursuant to notice filed as WSR 92-11-048 on May 19, 1992.

Effective Date of Rule: Thirty-one days after filing.

July 6, 1992

Mary Riveland  
Licensing Director

AMENDATORY SECTION (Amending WSR 91-04-026, filed 1/29/91, effective 3/1/91)

WAC 308-57-230 FLEET ABATEMENT. A fleet vehicle, which is required ((by WAC 308-96A-260)) to have a December registration expiration date, shall be charged excise tax based on the current depreciation rate for the number of months required to license through December. If the ((owner wishes to renew the registration for this fleet)) vehicle is registered for the following year at the same time, ((the vehicle shall also be

~~charged~~) an additional twelve months excise tax shall be charged at the following year's depreciation rate.

AMENDATORY SECTION (Amending Order MV 208, filed 7/31/74)

WAC 308-56A-010 TITLE PURPOSE ONLY. Certificates of title may be issued ~~((to vehicles))~~ without ~~((issuing a))~~ certificates of registration ~~((This does not apply to travel trailers and campers, unless held in a dealer's inventory but may include))~~ including but not limited to the following vehicles:

- (1) Vehicles required to display valid vehicle number license plates prior to operating on the public highway pursuant to chapter 46.16 RCW;
- (2) Farm tractors or farm equipment;
- (3) ~~((All terrain))~~ Off-road vehicles (ORV) whether or not required to obtain an ~~((ATV))~~ ORV use permit;
- (4) Golf carts and dune buggies whether or not equipped for legal highway use;
- (5) Off highway equipment that may be moved upon public highways by special permits.

AMENDATORY SECTION (Amending Order MV 208, filed 7/31/74)

WAC 308-56A-040 FORM REQUIRED FOR NAME AND ADDRESS—ADDRESS. The address of the registered and legal owner must be shown on the application as the address at which the owner regularly receives mail. If there is a change in the address, the department must be notified with the following information:

- (1) The registered owner's name as it appears on the department records ~~((must be printed or typed))~~;
- (2) The license plate number of each vehicle;
- (3) The new address with zip code and county of the new address;
- (4) Whether or not the new address is in an incorporated or unincorporated area~~((;~~
- (5) ~~The school district number where the vehicle generally is located is required for each travel trailer and camper).~~

AMENDATORY SECTION (Amending Order MV 208, filed 7/31/74)

WAC 308-56A-250 SIGNATURE OF REGISTERED OWNER ON APPLICATION—EXCEPTIONS. On an application for an original, reissue, or transfer of certificate of title, the signature of each and every named registered owner of the vehicle is required except:

- (1) When the application is for the sole purpose of removing a legal owner of record from the certificate of title when that legal owner's security interest has been satisfied in the vehicle;
- (2) When authorized supportive documentation is used in lieu of the signature or signatures;
- (3) When the legal owner applies for a duplicate title;
- (4) When there is a ~~((change in the))~~ statutorily authorized lien filed by a government agency to place a lien against the vehicle as a secured party.

(5) When an existing legal owner's perfected security interest is transferred to another party and the new legal owner is perfecting their security interest and removing the existing legal owner. Evidence or documentation of the secured interest transfer must be provided.

AMENDATORY SECTION (Amending Order MV 208, filed 7/31/74)

WAC 308-56A-450 GLIDER KITS. (1) A glider kit is a new cab and chassis designed for assembly with an existing truck or truck-tractor's axles, wheels and power train.

(2) The following procedures will be followed in ~~((fitting out the))~~ filing an application for ((reissue of)) title:

- (a) The model year of the vehicle will ~~((become))~~ be the year ~~((during which))~~ designated by the kit ((is installed)) manufacturer or the Washington state patrol;
- (b) The make of the vehicle will ~~((become))~~ be the make of the kit;
- (c) The series and body type will include the initials GL;
- (d) The identification number of the vehicle will be determined by an authorized vehicle identification inspector.

(3) The application for title must be accompanied by the following documents:

- (a) The previously issued certificates of title ~~((and registration))~~;
- (b) The previously issued ~~((tonnage))~~ gross weight license when applying for credit against the registration fee;
- (c) A certificate of inspection by an authorized member of the Washington state patrol verifying the vehicle identification number and of component parts not included in the glider kit manufacturer's statement of origin (MSO);
- (d) A certified weight slip showing the new scale weight of the vehicle;
- (e) ~~((A manufacturer's statement of origin))~~ An MSO or bill of sale of the kit;
- (f) ~~((An assessor's appraisal to establish the basis for determining the applicable amount of excise tax.))~~ A declaration of value form provided by the department.

AMENDATORY SECTION (Amending Order MV 208, filed 7/31/74)

WAC 308-56A-455 ASSEMBLED AND HOME-MADE VEHICLES. (1) Assembled and homemade vehicles are vehicles that have either (a) been put together by using major component parts from two or more commercially manufactured vehicles (major component parts often carry separate identification numbers); (b) have been structurally modified so that it does not have the same appearance as a similar vehicle from the same manufacturer; or (c) have been put together from parts and materials not obtained from other vehicles. An assembled vehicle can be one that has been sold by a wrecker who listed the vehicle on his wrecker's report pursuant to chapter 308-61 WAC. The difference between an assembled and a homemade vehicle is that an assembled vehicle will be recognizable as one produced



by a particular manufacturer. A homemade vehicle will be a vehicle that cannot, visually, be identified as one produced by a particular manufacturer. The model year of a homemade vehicle will be the original year of licensing and the make will be homemade.

(2) The following procedures must be followed in applying for a certificate of title:

(a) If the assembly or repair of the vehicle will involve the removal, destruction, or concealment of any identification number, the parts shall be inspected by an authorized member of the Washington state patrol prior to the removal, destruction, or concealment of the number.

(b) The vehicle identification number will be determined and/or assigned by an authorized member of the Washington state patrol, or other personnel authorized by the director.

(c) The application for certificate of title must be accompanied by the following documents:

(i) The certificate of title for each vehicle used in the assembly of the vehicle or bills of sale for each major component part used in the assembly of the vehicle. The bills of sale must be notarized unless the vendor has a regular place of business and is registered with the department of revenue as an agent for use tax purposes. Such bill of sale shall include the names and addresses of the seller and purchaser; a description of the vehicle or part being sold, including the make, model and identification or serial number; the date of sale; and the purchase price of the vehicle or part.

(ii) A statement from the authorized inspector verifying the vehicle identification number.

(iii) ~~((An assessor's appraisal to determine the value for excise tax.))~~ A declaration of value form provided by the department.

**AMENDATORY SECTION** (Amending WSR 91-04-025, filed 1/29/91, effective 3/1/91)

**WAC 308-56A-460 DESTROYED VEHICLE REBUILT.** (1) Any vehicle reported as destroyed pursuant to WAC 308-58-020 (1) or (2) that will be operated on any public road or highway, must be issued a new certificate of ownership and registration. The application for a new title shall include a Washington state patrol inspection and a bill of sale from:

(a) The insurance company that declared the vehicle a total loss, less salvage value; or

(b) A motor vehicle wrecker; or

(c) The last registered owner of record with the department.

(2) When the last registered owner retains a vehicle that is reported destroyed, the owner must apply for a new certificate of ownership before operating the vehicle upon a public road or highway. The application for title must include a Washington state patrol inspection and a bill of sale as provided in subsection (1) of this section.

(3) ~~((The))~~ Regular license plates ((from)) assigned to a destroyed vehicle ((shall not)) may be transferred to a new owner of the vehicle. Fees will be charged ((as if the vehicle was being titled and licensed for the first time)) for a reissue of title and for an expired registration. If the owner of record retains the vehicle, ((the)) a fee will be charged ((will be that)) for reissue of title

and for an expired registration. The license plates may be retained.

(4) Before a vehicle dealer may sell a destroyed vehicle under their vehicle dealer license, the dealer must:

(a) Rebuild the vehicle to standards set by the state of Washington or the federal government pertaining to the construction and safety of vehicles; and

(b) Obtain a Washington state patrol inspection; and

(c) Apply for and receive a certificate of title for the vehicle, issued in the name of the vehicle dealer.

**AMENDATORY SECTION** (Amending Order TL/RG 46, filed 11/9/88)

**WAC 308-56A-465 FLEETS.** Any person that has been issued a fleet identifier code by the department who makes application for ~~((title by))~~ a ~~((registered owner having fifteen or more))~~ vehicle certificate of ownership may have the vehicle~~((s))~~ registered ~~((in that name shall be identified))~~ as a ~~((<sup>x</sup>))~~part of their fleet~~((<sup>x</sup>))~~ by placing ~~((this<sup>x</sup>))~~their fleet ~~((owner<sup>x</sup>))~~ identifier ~~((symbol))~~ code on the application. ~~((The identifier symbol is issued by the department of licensing in Olympia.))~~

#### REPEALER

The following section of the Washington Administrative Code is repealed:

**WAC 308-56A-260 SIGNATURE OF LEGAL OWNER ON APPLICATION.**

#### **WSR 92-15-025**

##### **PERMANENT RULES**

##### **DEPARTMENT OF LICENSING**

[Filed July 6, 1992, 4:47 p.m.]

Date of Adoption: July 1, 1992.

Purpose: Housekeeping amendments and changes in the number of vehicles needed to qualify for a permanent fleet.

Citation of Existing Rules Affected by this Order: Amending WAC 308-96A-005, 308-96A-026, 308-96A-035, 308-96A-161, 308-96A-162, and 308-96A-275.

Statutory Authority for Adoption: RCW 46.01.110.

Pursuant to notice filed as WSR 92-11-050 on May 19, 1992.

Effective Date of Rule: Thirty-one days after filing.

July 6, 1992

Mary Riveland

Licensing Director

**AMENDATORY SECTION** (Amending WSR 92-02-100, filed 1/2/92, effective 2/2/92)

**WAC 308-96A-005 TERMINOLOGY.** (1) The terms "licensing" and "registering" are synonymous for a transaction in which either the vehicle's registration expiration or the gross weight license or both is updated on the department's records. A registration certificate and current validation tabs are issued to the applicant

unless the vehicle has current tabs or a permanent registration certificate and validation tabs, such as permanent fleet, Disabled American Veteran, or government owned vehicles.

(2) The terms "tonnage," "gross weight license," "license based on gross weight," and "gross weight fees" are used interchangeably when referring to license fees that are collected annually from owners of motor trucks, truck tractors, road tractors, tractors, bus, auto stage, or for hire vehicles with seating capacity of more than six, based upon the declared combined gross weight or declared gross weight.

(3) "Capacity fee" is used to refer to the load license for stages and for-hire vehicles with seating capacity of six or less and for fixed load vehicles including circus and tow.

(4) The term "no bill" refers to the notice to renew a license which is mailed by the department to the registered owner in lieu of a prebill. ~~((This form indicates))~~ The no bill requires additional information ~~((that is required))~~ prior to the registration for the current year license.

(5) A "prebill" is the notice to renew a vehicle license which is mailed by the department to the registered owner.

(6) References to "current year" mean the current registration year unless otherwise stated.

(7) "Month of expiration" or "expiration month" is the calendar month during which a registration year ends.

(8) A "fleet" is a group of ~~((fifteen or more))~~ vehicles registered in the same owner name and which have been assigned the same fleet identifier code by the department.

(a) "Perm or permanent fleet" means a fleet of one hundred or more commercial vehicles licensed to one registered owner where each vehicle is issued nonexpiring tabs and registration. ~~((Individual permanent fleet vehicles are not eligible for monthly license fee based on gross weight.))~~

(b) "Regular fleet" means a fleet licensed to one registered owner where each vehicle is issued year and month tabs.

(9) "License fee" means and is limited to the fees required for the act of licensing a vehicle as set forth in chapter 46.16 RCW. License fee excludes the fees required for special vehicle license plates authorized by chapter 46.16 RCW.

(10) "Ride sharing van" for purposes of RCW 82.08-.0287, 82.12.0282, and 82.44.015 means a passenger vehicle with a seating capacity of no fewer than seven nor more than fifteen persons including the driver. The seating capacity may not be fewer than five persons including the driver when at least three passengers are confined to a wheelchair.

(11) "Day of expiration" is the day of the month that the registration, gross weight license, and tabs expire.

AMENDATORY SECTION (Amending Order TL/RG 28, filed 11/18/86)

WAC 308-96A-026 VEHICLE TRANSIT PERMIT ~~((PRIOR TO REGISTRATION))~~. A vehicle

transit permit may be issued to authorize an individual to operate a vehicle over and along a public highway of this state solely for the purpose of doing what is necessary to qualify the vehicle for a Washington certificate of ~~((vehicle))~~ ownership or registration. Such purposes are limited to the following:

(1) Obtaining a Washington state patrol inspection (if required);

(2) Obtaining a weight slip;

(3) Obtaining an emission test; or,

(4) ~~((Another specific))~~ Any other purpose which the director or designee in his or her discretion deems necessary ~~((in order to obtain a Washington certificate of registration for the vehicle.~~

~~There is no fee charged for this permit)).~~

The permit is valid for a maximum of two days ~~((only))~~ and shall contain, but is not ~~((be))~~ limited to, the following information:

(a) Signature and agency number of persons issuing the permit;

(b) Signature and address of person receiving the permit;

(c) Description, including make, model, model year, and vehicle identification number, of the vehicle for which the permit is issued;

(d) Specific purpose for which the permit is issued; and,

(e) The date or dates on which the permit is valid, for a maximum of two days.

AMENDATORY SECTION (Amending Order TL/RG 24, filed 5/5/86)

WAC 308-96A-035 ~~((MANUAL))~~ ANNUAL LICENSE RENEWAL—NO PREBILL/CORRECTION. (1) ~~((If errors exist on the prebill or if the))~~ When a registered owner wishes to make a change ~~(("class," "tonnage," etc.))~~ to the information pertaining to the vehicle or their owner address, or if a prebill was not received, application shall be made ~~((on a manual form furnished by the department))~~ by mailing or appearing in person at any of the vehicle licensing offices to effect such change or to renew the registration.

(2) The applicant must satisfy the licensing agent as to his/her identity by at least one of the following:

(a) A valid Washington state driver's license;

(b) A valid Washington state identicaid;

(c) A photo identification card;

Or in the event the above are not available, two of the following:

A nationally or regionally known credit card containing the signature of the applicant;

An identification card issued by the United States, any state, or any agency of either, of a kind commonly used to identify the members or employees of such government agencies (including military ID cards) and which contain the signature of the applicant;

Any certificate or other document issued by any governmental agency commonly used for the purpose of establishing identities; or

Such other documentary evidence as in the opinion of the licensing agency clearly establishes the identity of the applicant.

(3) Nothing in this regulation shall be construed as prohibiting a member of the immediate family of the registered owner to effect such ~~((manual))~~ renewal, if he/she is able to prove his/her identity and relationship to the registered owner.

**AMENDATORY SECTION** (Amending WSR 91-15-006, filed 7/8/91, effective 8/8/91)

WAC 308-96A-161 **REGULAR FLEET REGISTRATION.** Any owner of a fleet of fifteen or more vehicles may apply for and be issued a regular fleet identifier code by the department. The owner may have any vehicle with a certificate of title in the same owner name registered using the regular fleet identifier code. Regular vehicle license plate month and year tabs shall be issued. Monthly ~~((tonnage))~~ gross weight license may be purchased for individual vehicles.

Any vehicle with an expired registration will be removed from the regular fleet. Failure of the owner to maintain a minimum of fifteen vehicles with current registrations under the owner's fleet identification code shall automatically cause cancellation of their fleet identification code and removal of all of the owner's vehicles from the regular fleet designation.

**AMENDATORY SECTION** (Amending WSR 91-15-006, filed 7/8/91, effective 8/8/91)

WAC 308-96A-162 **PERMANENT FLEET REGISTRATION.** (1) Any owner of a fleet of one hundred or more vehicles used for commercial purposes may apply for and be issued a permanent fleet identifier code by the department. Permanent fleets that were issued identifies codes prior to April 1986 may continue to use the permanent fleet code issued without satisfying the one hundred or more vehicle requirement set forth in this section. The owner may have any vehicle used for commercial purpose, with a certificate of title in the same owner name registered using the permanent fleet identifier code. Nonexpiring license plate tabs and registration documents shall be issued. Annual ~~((tonnage))~~ gross weight license must be purchased for ~~((individual))~~ each applicable vehicle((s)).

(2) Any vehicle with an expired registration will be removed from the fleet. Failure of the owner to maintain a minimum of one hundred vehicles with current registrations under the owner's fleet identifier code except as provided in subsection (1) of this section shall automatically cause cancellation of their permanent fleet identifier code and removal of all of the owner's vehicles from the permanent fleet designation.

**AMENDATORY SECTION** (Amending WSR 92-02-100, filed 1/2/92, effective 2/2/92)

WAC 308-96A-275 **ASSIGNMENT OF ~~((RENEWAL))~~ FLEET REGISTRATION EXPIRATION.** Registration renewals for fleet vehicles will be for twelve months expiring on December 31 of the following year. If a vehicle is added to a fleet or is prorated, fees will be

~~((charged))~~ collected for the number of months necessary to have a December 31 registration expiration date. For any partial month from the current expiration date to the December 31 expiration date, a full month's fees will be charged. Fees may be ~~((charged))~~ collected from ~~((one))~~ four to eighteen months to adjust the expiration date. Any vehicle added to a fleet from October 1 through December 31 will be issued an expiration date of December 31 of the following year.

## WSR 92-15-026

### PROPOSED RULES

#### DEPARTMENT OF AGRICULTURE

[Filed July 7, 1992, 9:16 a.m.]

Original Notice.

Title of Rule: Rules relating to reentry intervals for all dry wettable formulations of ziram labeled for use on pears in chapter 16-228 WAC.

Purpose: To protect unprotected workers in Bosc pear orchards treated with dry flowable ziram.

Statutory Authority for Adoption: Chapters 15.58 and 17.21 RCW.

Statute Being Implemented: Chapters 15.58 and 17.21 RCW.

Reasons Supporting Proposal: This request is based on a report and investigation of skin rashes experienced by workers exposed to ziram while picking Bosc pears.

Name of Agency Personnel Responsible for Drafting: Glenn Smerdon, Registration and Licensing, 2627A Parkmont Lane, Olympia, WA 98902 [98502], 753-5064; Implementation: Art G. Losey, Assistant Director; and Enforcement: Cliff Weed, Compliance Branch.

Name of Proponent: Pesticide Incident Reporting and Tracking Review (PIRT) Panel, governmental.

Rule is not necessitated by federal law, federal or state court decision.

Explanation of Rule, its Purpose, and Anticipated Effects: Based on a report and investigation of skin rashes experienced by workers exposed to ziram while picking Bosc pears, the pesticide incident reporting and tracking review (PIRT) panel requested establishment of a reentry interval for unprotected workers in Bosc pear orchards treated with dry flowable ziram. The proposed rules establishes reentry intervals for all dry wettable formulations of ziram labeled for use on pears.

Proposal does not change existing rules.

No small business economic impact statement is required for this proposal by chapter 19.85 RCW.

Hearing Location: On August 25, 1992, beginning at 1:30 p.m., Agricultural Conference Room, 2015 South 1st Street, Yakima, WA 98903; and on August 26, 1992, beginning at 9:30 a.m., Tree Fruit Research Center, 1100 North Western Avenue, Wenatchee, WA 98801.

Submit Written Comments to: Hearing Officer, Washington State Department of Agriculture, P.O. Box 42589, Olympia, WA 98504-2589, by August 26, 1992, 5:00 p.m.

Date of Intended Adoption: September 4, 1992.  
 July 7, 1992  
 Art G. Losey  
 Assistant Director

AMENDATORY SECTION (Amending Order 3122, filed 12/28/90, effective 1/28/91)

WAC 388-29-295 STANDARDS OF ASSISTANCE—SUPPLEMENTAL SECURITY INCOME (SSI) PROGRAM. Effective January 1, ((1991)) 1992, the standards of SSI assistance paid to an eligible individual and couple are:

NEW SECTION

WAC 16-228-500 RE-ENTRY INTERVAL—ZIRAM. All dry wettable formulations (such as wettable powders or water dispersible granules) of ziram labeled for use on pears are hereby declared state restricted use pesticides because of dermal effects to the persons exposed while working in Bosc pear orchards.

1) Growers shall observe a fourteen-day interval following treatment with dry wettable formulations of ziram before entering or allowing persons to enter Bosc pear orchards without personal protective clothing.

2) Personal protective clothing shall be that which is required by the label for re-entry but shall consist of no less than long-sleeved shirt, long-legged pants and rubber gloves.

**WSR 92-15-027**  
**PROPOSED RULES**  
**DEPARTMENT OF**  
**SOCIAL AND HEALTH SERVICES**  
**(Public Assistance)**

[Filed July 7, 1992, 11:40 a.m.]

Original Notice.

Title of Rule: WAC 388-29-295 Standards of assistance—Supplemental security income (SSI) program.

Purpose: SSI standards are reviewed/updated annually.

Statutory Authority for Adoption: RCW 74.04.620.

Statute Being Implemented: RCW 74.04.620.

Summary: Will enable staff to reference correct standards in making benefit payments to clients effective January 1, 1992.

Reasons Supporting Proposal: SSI standards are updated annually.

Name of Agency Personnel Responsible for Drafting, Implementation and Enforcement: Dave Monfort, Division of Income Assistance, 438-8304.

Name of Proponent: Department of Social and Health Services, governmental.

Rule is necessary because of federal law, 20 CFR 416.405.

Explanation of Rule, its Purpose, and Anticipated Effects: Same as above.

Proposal Changes the Following Existing Rules: See above.

No small business economic impact statement is required for this proposal by chapter 19.85 RCW.

Hearing Location: OB-2 Auditorium, 12th and Franklin, Olympia, Washington, on August 25, 1992, at 10:00 a.m.

Submit Written Comments to: Troyce Warner, Chief, Office of Issuances, Mailstop 5805, Department of Social and Health Services, Olympia, 98504, TELEFAX 664-0118 or SCAN 366-0118, by August 25, 1992.

Date of Intended Adoption: August 26, 1992.

July 7, 1992  
 Leslie F. James, Director  
 Administrative Services

	Standard	Federal SSI Benefit	State Supplement
<b>Area I: King, Pierce, Snohomish, Thurston, and Kitsap Counties</b>			
Living alone			
Individual	\$(( <del>435.00</del> — <del>5407.00</del> )) 450.00	422.00	\$ 28.00
Couple			
Both eligible	(( <del>632.00</del> — <del>610.00</del> )) 655.00	633.00	22.00
With essential person	(( <del>633.00</del> — <del>611.00</del> )) 655.00	633.00	22.00
With ineligible spouse	(( <del>599.00</del> — <del>407.00</del> )) 614.00	422.00	192.00
<b>Area II: All Counties Other Than the Above</b>			
Living alone			
Individual	(( <del>414.55</del> — <del>407.00</del> )) 429.55	422.00	7.55
Couple			
Both eligible	(( <del>610.00</del> — <del>610.00</del> )) 633.00	633.00	0
With essential person	(( <del>611.00</del> — <del>611.00</del> )) 633.00	633.00	0
With ineligible spouse	(( <del>567.15</del> — <del>407.00</del> )) 582.15	422.00	160.15
<b>Areas I and II: Shared living (all counties)</b>			
Individual	(( <del>277.15</del> — <del>271.34</del> )) 287.15	281.34	5.81
Couple			
Both eligible	(( <del>412.97</del> — <del>406.67</del> )) 428.30	422.00	6.30
With essential person	(( <del>413.64</del> — <del>407.34</del> )) 428.30	422.00	6.30
With ineligible spouse	(( <del>390.97</del> — <del>271.34</del> )) 400.97	281.34	119.63

**WSR 92-15-028**  
**PROPOSED RULES**  
**DEPARTMENT OF**  
**SOCIAL AND HEALTH SERVICES**  
**(Public Assistance)**

[Filed July 7, 1992, 11:42 a.m.]

Original Notice.

Title of Rule: WAC 388-47-070 JOBS program—Priority of services.

Purpose: Amended due to the passage of HB 2983 during the 1992 regular session.

Statutory Authority for Adoption: RCW 74.25.020.

Statute Being Implemented: RCW 74.25.020.

Summary: Requires parents under twenty-four years of age to participate in orientation, assessment, and either education, vocational training, or employment programs. Requires at least one parent in a two-parent family to participate in orientation, assessment, and either job search, education, training, or employment.

Reasons Supporting Proposal: To make it mandatory that certain persons receiving AFDC participate in the JOBS program.

Name of Agency Personnel Responsible for Drafting, Implementation and Enforcement: Lee Burnett, Division of Income Assistance, 438-8273.

Name of Proponent: Department of Social and Health Services, governmental.

Rule is not necessitated by federal law, federal or state court decision.

Explanation of Rule, its Purpose, and Anticipated Effects: Same as above.

Proposal Changes the Following Existing Rules: See above.

No small business economic impact statement is required for this proposal by chapter 19.85 RCW.

Hearing Location: OB-2 Auditorium, 12th and Franklin, Olympia, Washington, on August 25, 1992, at 10:00 a.m.

Submit Written Comments to: Troyce Warner, Chief, Office of Issuances, Mailstop 5805, Department of Social and Health Services, Olympia, 98504, TELEFAX 664-0118 or SCAN 366-0118, by August 25, 1992.

Date of Intended Adoption: August 25, 1992.

July 6, 1992

Leslie F. James, Director  
Administrative Services

**AMENDATORY SECTION** (Amending Order 3129, filed 12/31/90, effective 1/31/91)

WAC 388-47-070 JOBS PROGRAM—PRIORITY OF SERVICES. A person's participation in JOBS activities shall be in accordance with the priorities of service set forth in this section and based on criteria for approval of participation in individual JOBS components. The department shall require nonexempt parents under twenty-four years of age to actively participate in orientation, assessment, and either education, vocational training, or employment programs. The department shall require one or more parents in the aid to families with dependent children employable program to actively participate in orientation, assessment, and either job search education, training, or employment. (1) The contractor shall give first priority for JOBS activity participation to target group volunteers (~~(in the target groups)~~). Target groups include:

- (a) An AFDC recipient and applicant who received AFDC assistance for thirty-six or more of the preceding sixty months;
- (b) A custodial parent under twenty-four years of age who did not complete high school and is not enrolled in high school, or a high school equivalent, at the time of application;
- (c) A custodial parent under twenty-four years of age having little or no work experience in the preceding year; or
- (d) A member of a family where the youngest child is within two years of ineligibility for AFDC because of age.

(2) The contractor shall give second priority for JOBS activity participation to other volunteers.

(3) The contractor shall give third priority for JOBS activity participation to nonexempt persons in a target group who do not volunteer.

(4) The contractor shall give fourth priority for JOBS activity participation to other nonexempt persons who do not volunteer.

(5) An AFDC applicant or recipient may volunteer for one or more JOBS components.

**WSR 92-15-029**  
**EMERGENCY RULES**  
**DEPARTMENT OF**  
**SOCIAL AND HEALTH SERVICES**  
**(Public Assistance)**

[Order 3416—Filed July 7, 1992, 11:44 a.m., effective July 8, 1992, 12:01 a.m.]

Date of Adoption: July 7, 1992.

Purpose: SSI standards are reviewed/updated annually.

Citation of Existing Rules Affected by this Order: Amending WAC 388-29-295 Standards of assistance—Supplemental security income (SSI) program.

Statutory Authority for Adoption: RCW 74.04.620.

Pursuant to RCW 34.05.350 the agency for good cause finds that immediate adoption, amendment, or repeal of a rule is necessary for the preservation of the public health, safety, or general welfare, and that observing the time requirements of notice and opportunity to comment upon adoption of a permanent rule would be contrary to the public interest.

Reasons for this Finding: SSI standards are updated annually.

Effective Date of Rule: July 8, 1992, 12:01 a.m.

July 7, 1992

Leslie F. James, Director  
Administrative Services

**AMENDATORY SECTION** (Amending Order 3122, filed 12/28/90, effective 1/28/91)

WAC 388-29-295 STANDARDS OF ASSISTANCE—SUPPLEMENTAL SECURITY INCOME (SSI) PROGRAM. Effective January 1, ~~((1991))~~ 1992, the standards of SSI assistance paid to an eligible individual and couple are:

	Federal SSI Standard	State Benefit	Supplement
<b>Area I: King, Pierce, Snohomish, Thurston, and Kitsap Counties</b>			
<i>Living alone</i>			
<i>Individual</i>	<del>\$(435.00)</del> 450.00	<del>407.00</del> 422.00	\$ 28.00
<i>Couple</i>			
<i>Both eligible</i>	<del>((632.00))</del> 655.00	<del>610.00</del> 633.00	22.00
<i>With essential person</i>	<del>((633.00))</del> 655.00	<del>611.00</del> 633.00	22.00
<i>With ineligible spouse</i>	<del>((599.00))</del> 614.00	<del>407.00</del> 422.00	192.00
<b>Area II: All Counties Other Than the Above</b>			
<i>Living alone</i>			
<i>Individual</i>	<del>((414.55))</del> 429.55	<del>407.00</del> 422.00	7.55

	Standard	Federal SSI Benefit	State Supplement
<b>Couple</b>			
Both eligible	<del>((610.00-610.00))</del> 633.00	633.00	0
With essential person	<del>((611.00-611.00))</del> 633.00	633.00	0
With ineligible spouse	<del>((567.15-407.00))</del> 582.15	422.00	160.15
<b>Areas I and II: Shared living (all counties)</b>			
Individual	<del>((277.15-271.34))</del> 287.15	281.34	5.81
<b>Couple</b>			
Both eligible	<del>((412.97-406.67))</del> 428.30	422.00	6.30
With essential person	<del>((413.64-407.34))</del> 428.30	422.00	6.30
With ineligible spouse	<del>((390.97-271.34))</del> 400.97	281.34	119.63

**WSR 92-15-030**  
**NOTICE OF PUBLIC MEETINGS**  
**CONVENTION AND TRADE**  
**CENTER**

[Memorandum—July 2, 1992]

**NOTICE OF REGULAR AND SPECIAL PUBLIC MEETINGS**

A regular meeting of the board of directors of the Washington State Convention and Trade Center (WSCTC) will be held on Saturday, July 11, 1992, at 10:30 a.m. in Victoria Room at the Inn at Semiahmoo, 9565 Semiahmoo Parkway, Blaine, WA.

A retreat of the WSCTC board of directors will be also held at the Inn at Semiahmoo commencing at 11:30 a.m. on Saturday, July 11, and at 9:00 a.m. on Sunday, July 12.

The purpose of the retreat is to discuss the capital improvement program and the 1994-95 biennium budget.

If you have any questions regarding these meetings, please call 447-5000.

**WSR 92-15-031**  
**NOTICE OF PUBLIC MEETINGS**  
**FOREST PRACTICES BOARD**

[Memorandum—July 7, 1992]

This notice is given pursuant to provisions of RCW 42-30.075 and WAC 222-08-040.

The Washington Forest Practices Board will hold its regular quarterly meeting August 12, 1992. The meeting

will convene at 1 p.m. in the Auditorium of Office Building 2, East Capitol Campus, Olympia.

Additional information may be obtained from: Forest Practices Division, P.O. Box 47012, Olympia, WA 98504-7012, (206) 753-5315.

**WSR 92-15-032**  
**PERMANENT RULES**  
**DEPARTMENT OF HEALTH**  
 [Order 285—Filed July 7, 1992, 2:53 p.m.]

Date of Adoption: July 1, 1992.

Purpose: Changing the wording to current publication for recognized educational programs, adding a new section for temporary permits and adding a fee for temporary permits.

Citation of Existing Rules Affected by this Order: Amending WAC 246-928-020 and 246-928-990.

Statutory Authority for Adoption: WAC 246-928-020 is RCW 18.89.050; WAC 246-928-085 is RCW 18.130.050 and [18.130].075; and WAC 246-928-990 is RCW 43.70.250.

Pursuant to notice filed as WSR 92-10-071 on May 6, 1992.

Effective Date of Rule: Thirty-one days after filing.

July 1, 1992

Kristine M. Gebbie  
 Secretary

**AMENDATORY SECTION** (Amending Order 121, filed 12/27/90, effective 1/31/91)

WAC 246-928-020 **RECOGNIZED EDUCATIONAL PROGRAMS—RESPIRATORY CARE PRACTITIONERS**. Approved courses of instruction for respiratory care practitioners are recognized as the respiratory therapy technician and respiratory therapy education programs that have obtained accreditation from the Committee on Allied Health Education and Accreditation of the American Medical Association in collaboration with the Joint Review Committee for Respiratory Therapy Education as recognized in the current publication Respiratory Therapy Educational Programs published by the Joint Review Committee for Respiratory Therapy Education(~~(, revised May, 1987)~~).

**NEW SECTION**

WAC 246-928-085 **TEMPORARY PERMITS—ISSUANCE AND DURATION**. (1) An applicant who is currently licensed in another state and is applying for certification in Washington state may request a temporary practice permit by submitting to the department:

(a) A completed application on forms provided by the department with the request for a temporary practice permit indicated;

(b) An application fee and a temporary practice permit fee as specified in WAC 246-928-990; and

(c) Written verification directly from all states in which the applicant is or was licensed, attesting that the applicant has or had a license in good standing and is

not subject to charges or disciplinary action for unprofessional conduct or impairment.

(2) The department shall issue a one-time-only temporary practice permit unless the department determines a basis for denial of the license or issuance of a conditional license.

(3) The temporary permit shall expire upon the issuance of a certificate by the department, initiation of an investigation of the applicant by the department, or three months, whichever occurs first.

(4) An applicant who receives a temporary practice permit and does not complete the application process shall not be issued another temporary practice permit, even upon submission of a new application in the future.

**AMENDATORY SECTION** (Amending Order 224, filed 12/23/91, effective 1/23/92)

WAC 246-928-990 FEES. The following fees shall be charged by the professional licensing division of the department of health:

Title of Fee	Fee
Application	\$ 85.00
<u>Temporary practice permit</u>	<u>50.00</u>
Examination application	110.00
Examination retake	25.00
Duplicate license	15.00
Verification/certification	25.00
Renewal	100.00
Late renewal penalty	50.00

**WSR 92-15-033**  
**PERMANENT RULES**  
**DEPARTMENT OF HEALTH**  
 [Order 284—Filed July 7, 1992, 2:55 p.m.]

Date of Adoption: July 1, 1992.

Purpose: Provides appeal process for examination candidates who failed the exam.

Citation of Existing Rules Affected by this Order: Amending WAC 246-815-090.

Statutory Authority for Adoption: RCW 18.29.120(5).

Pursuant to notice filed as WSR 92-11-014 on May 12, 1992.

Effective Date of Rule: Thirty-one days after filing.

July 1, 1992  
 Kristine M. Gebbie  
 Secretary

**AMENDATORY SECTION** (Amending Order 121, filed 12/27/90, effective 1/31/91)

WAC 246-815-090 PRACTICAL EXAMINATION REVIEW PROCEDURES. (1) Any candidate who takes the practical examination for licensure as a dental hygienist and does not pass may request informal review by the examining committee of his or her examination results. This request must be in writing and must be received by the department within twenty days of the

postmark date of the mailing of the practical examination score sheets. The examining committee will not set aside its prior determination unless the candidate shows, by a preponderance of evidence, significant error in examination procedure, bias, fraud or discrimination in the examination process.

(2) The procedure for filing an informal review is as follows:

(a) Request, on the form provided with the examination results, a copy of the score sheets on the failed practical portion of the examination. This request must be in writing and must be received by the department within fifteen days of the postmark date of notification of the examination results.

(b) The candidate will be provided along with the copies of the failed grade sheets a form to complete on which the candidate must specifically identify the challenged portion(s) of the examination and must state the specific reason(s) why the candidate believes the results of the examination should be changed. Such form must be returned to the department within twenty days of the postmark date of the mailing of the practical examination score sheets.

(c) The candidate will be identified only by candidate number for the purpose of this review. Letters of reference, requests for special consideration, or any reexamination of the patient will not be considered by the examining committee. Patient difficulty will not be considered by the examining committee if the patient category selected by the candidate was accepted for the examination.

(d) The examining committee will schedule a closed session meeting to review the examination, score sheets, and form completed by the candidate for the purpose of informal review. Candidates are not permitted to attend.

(e) The candidate will be notified in writing of the results.

(3) Any candidate who is not satisfied with the result of the informal examination review may submit a written request for a formal hearing to be held before an administrative law judge. The hearing will be conducted under the Administrative Procedure Act, chapter 34.05 RCW and the rules adopted thereunder. The written request for a formal hearing must be received by the department of health within twenty days of the postmark date of the notification of the results of the informal review. The written request must specifically identify the challenged portion(s) of the examination and must state the specific reason(s) why the candidate believes the results of the examination should be changed. The final decision shall be made by the secretary of the department of health. The secretary will not modify the examination results unless the candidate shows, by a preponderance of evidence, significant error in examination ((content or)) procedure, bias, fraud or discrimination in the examination process.

(4) Before the hearing is scheduled the parties shall attempt by informal means to resolve the following:

(a) The simplification of issues;

(b) Amendments, if any, to the candidate's notice identifying the challenged portion(s) of the examination



and the statement of the specific reason(s) why the candidate believes the results of the examination should be changed;

(c) The obtaining of stipulations, admission of facts, and documents;

(d) The limitation of the number of witnesses;

(e) A schedule for completion of all discovery; and

(f) Such other matters as may aid in the disposition of the proceeding.

If the parties are unable to resolve any of these issues informally, either party shall request a prehearing conference to be held before the administrative law judge.

(5) In the event there is a prehearing conference, the administrative law judge shall enter an order which sets forth the actions taken at the conference, the amendments to the candidate's notice and the agreements reached by the parties as to any of the matters considered, including but not limited to the settlement or simplification of issues. The prehearing order limits the issues for hearing to those not disposed of by admissions or agreements. Such order shall control the subsequent course of the proceeding unless modified for good cause by subsequent prehearing order.

(6) Candidates will receive at least seven days notice of the time and place of the formal hearing. The hearing will be restricted to the specific portion(s) of the examination the candidate has identified as the basis for his or her challenge of the examination results unless amended by a prehearing order. The issues raised by the candidate at the formal hearing shall be limited to those issues raised by the candidate of consideration at the informal review unless amended by a prehearing order. Letters of reference, requests for special consideration or any reexamination of the patient will not be considered.

#### WSR 92-15-034

#### PROPOSED RULES

#### DEPARTMENT OF HEALTH

[Filed July 7, 1992, 3:02 p.m.]

#### Original Notice.

Title of Rule: New chapter 246-976 WAC, Emergency medical services and trauma care systems; and repealing chapter 246-975 WAC, Ambulances and chapter 246-977 WAC, Advanced life support technicians.

Purpose: To implement the EMS/Trauma Act of 1990; to consolidate all department rules relating to EMS/trauma services; and to reformat WAC for improved clarity.

Statutory Authority for Adoption: Chapter 18.71 RCW and RCW 43.70.040 for WAC 246-976-001, 246-976-010, 246-976-050, 246-976-055, 246-976-060, 246-976-065, 246-976-070, 246-976-075, 246-976-080, 246-976-085, 246-976-140, 246-976-170, 246-976-180, 246-976-190, 246-976-200, 246-976-210, 246-976-220, 246-976-230, 246-976-240, 246-976-920, 246-976-930 and 246-976-950; chapter 18.73 RCW and RCW 43.70.040 for WAC 246-976-001, 246-976-010, 246-976-020, 246-976-025, 246-976-030, 246-976-035, 246-976-040, 246-976-090, 246-

976-110, 246-976-115, 246-976-120, 246-976-140, 246-976-150, 246-976-160, 246-976-210, 246-976-220, 246-976-230, 246-976-240, 246-976-260, 246-976-270, 246-976-280, 246-976-290, 246-976-300, 246-976-310, 246-976-320, 246-976-330, 246-976-340, 246-976-350, 246-976-370, 246-976-920, 246-976-930, 246-976-950 and 246-976-990; and chapter 70.168 RCW and RCW 43.70.040 for WAC 246-976-001, 246-976-010, 246-976-390, 246-976-400, 246-976-420, 246-976-430, 246-976-440, 246-976-450, 246-976-470, 246-976-475, 246-976-480, 246-976-500, 246-976-510, 246-976-520, 246-976-550, 246-976-560, 246-976-570, 246-976-600, 246-976-610, 246-976-640, 246-976-650, 246-976-680, 246-976-690, 246-976-720, 246-976-730, 246-976-740, 246-976-770, 246-976-780, 246-976-790, 246-976-810, 246-976-820, 246-976-880, 246-976-885, 246-976-890, 246-976-910, 246-976-930, 246-976-940, 246-976-960, 246-976-970, and 246-976-990.

Statute Being Implemented: Chapters 18.71, 18.73, and 70.168 RCW.

Summary: Establish state trauma system including verification of prehospital services, designation of trauma facilities, trauma registry, and regional quality assurance programs; standards for air ambulance services; and update and consolidate previous EMS/trauma rules into one chapter.

Reasons Supporting Proposal: Implement Washington Trauma Systems Act; and update existing rules to consolidate under one chapter, reflect current knowledge and methods of treating emergency patients and clarify/simplify language.

Name of Agency Personnel Responsible for Drafting: Shane Sanderson, 1112 S.E. Quince, Olympia, 753-2095; Implementation and Enforcement: Janet Griffith, 1112 S.E. Quince, Olympia, 753-2095.

Name of Proponent: [No information supplied by agency], governmental.

Rule is not necessitated by federal law, federal or state court decision.

Explanation of Rule, its Purpose, and Anticipated Effects: Passage of chapter 70.158 RCW in 1990 established a state trauma system, which is implemented by these rules. Previous rules for emergency medical services have not been thoroughly reviewed and updated for over ten years. Also, previous rules were divided into two chapters of WAC, causing confusion and conflicting interpretations. These new rules will integrate "EMS" and "trauma care" systems.

Proposal Changes the Following Existing Rules: Chapter 246-975 WAC, Ambulances; and chapter 246-977 WAC, Advanced life support technicians, were repealed.

No small business economic impact statement is required for this proposal by chapter 19.85 RCW.

Impact of voluntary designation (physician's offices, medical clinics), or verification (ambulance services) is minor or negligible. Rules do not affect over 10% of any one business category or over 20% of all businesses.

Hearing Location: General Administration (GA) Auditorium, 11th and Columbia, Olympia, Washington 98504, on August 25, 1992, at 8:00 a.m.

Submit Written Comments to: Rules Coordinator,  
Department of Health, 1300 S.E. Quince, Olympia, WA  
98504-7902, by August 21, 1992.

Date of Intended Adoption: September 1, 1992.

July 1, 1992

Kristine M. Gebbie  
Secretary

Chapter 246-976 WAC  
EMERGENCY MEDICAL SERVICES AND TRAUMA CARE  
SYSTEMS

NEW SECTION

WAC 246-976-001 DECLARATION OF PURPOSE. The purpose of these rules is to implement RCW 18.71.200 through 18.71.215, and chapters 18.73 and 70.168 RCW; and those sections of chapter 70.24 RCW relating to EMS/TC personnel and services.

(1) This chapter sets forth standards governing the state-wide emergency medical services and trauma care (EMS/TC) System in order to:

- (a) Prevent unnecessary death and disability from trauma and emergency illness;
- (b) Provide optimal care for the trauma patient;
- (c) Contain costs of EMS/TC, and EMS/TC System Implementation; and
- (d) Pursue trauma prevention activities to decrease the incidence of trauma.

(2) This chapter establishes criteria for:

- (a) Basic Life Support training and certification;
- (b) Advanced Life Support training and certification;
- (c) Ambulance licensing and inspection;
- (d) The verification process for prehospital services/agencies providing EMS/TC;
- (e) The development and operation of a state-wide Trauma Registry;
- (f) The designation process of health care facilities to provide trauma care services;
- (g) Operation requirements for all levels of trauma care facilities;
- (h) A state-wide emergency medical communication system;
- (i) State-wide EMS/TC system administration.

(3) This chapter is not intended to constitute detailed procedures for implementation of the state EMS/TC system. Procedures and guidelines are available on request from the Office of EMS and Trauma Systems, Department of Health, Olympia, WA 98504.

NEW SECTION

WAC 246-976-010 DEFINITIONS. Unless a different meaning is plainly required by the context, the following words and phrases used in this chapter shall have the meanings indicated:

"ACLS" means advanced cardiac life support, a course developed by the American Heart Association.

"Activation of the trauma system" means a process whereby a pre-hospital provider identifies the major trauma patient by using the pre-hospital trauma triage procedures, and notifies from the field both dispatch and medical control, who mobilize resources to care for the patient in accordance with regional patient care procedures.

"Advanced life support" means invasive emergency medical services requiring advanced medical treatment skills as defined in chapter 18.71 RCW.

"Agency response time" means the time from agency notification to arrival on the scene. It is the same as the combination of activation and enroute times defined under system response times in this section.

"Aid service" means an agency, public or private, that operates one or more aid vehicles.

"Aid vehicle" means a vehicle used to carry aid equipment and individuals trained in first aid or emergency medical procedure.

"Air ambulance" means a fixed or rotary-winged aircraft that is configured to accommodate a minimum of one litter and two medical attendants with sufficient space to provide intensive life-saving care without interfering with the performance of the flight crew, and has been inspected and licensed by the department as an air ambulance.

"Airway technician" means a person certified to provide mobile airway management as defined in RCW 18.71.200(2).

"Ambulance" means a ground or air vehicle designed and used to transport the ill and injured and to provide personnel, facilities, and equipment to treat patients before and during transportation.

"Ambulance service" means an agency, public or private, that operates one or more ground or air ambulances.

"Approved" means approved by the department of health.

"ATLS" means advanced trauma life support, a course developed by the American College of Surgeons.

"Attending surgeon" means a physician who is board-certified or board-eligible in general surgery, and who has surgical privileges delineated by the facility's medical staff. The attending surgeon is responsible for care of the trauma patient, participates in all major therapeutic decisions, and is present during operative procedures.

"Basic life support" means noninvasive emergency medical services requiring basic medical treatment skills as defined in chapter 18.73 RCW.

"BP" means blood pressure.

"Certification" means recognition by the department of the competence of an individual who has met predetermined qualifications, and the authorization of the individual to perform certain procedures for which they have been trained or are otherwise qualified.

"CME" means continuing medical education.

"Communications system" means a radio and landline network which provides rapid public access, coordinated central dispatching of services, and coordination of personnel, equipment and facilities in an EMS/TC system.

"Consumer" means an individual who is not associated with the EMS/TC system, either for pay or as a volunteer, except for service on the steering committee, licensing and certification committee, or regional or local EMS/TC councils.

"Continuing medical education (CME)" means ongoing education after initial certification for the purpose of maintaining and enhancing skill and knowledge.

"Council" means the local or regional EMS/TC council as authorized under chapter 70.168 RCW.

"Course coordinator" means an individual who has overall administrative responsibility for coordinating an EMS/TC course or program of continuing education.

"CPR" means cardiopulmonary resuscitation.

"Department" means the department of health.

"Designated trauma care service" means a level I, II, III, IV, or V trauma care service, or level I, II, or III pediatric trauma care service, or level I, I-pediatric, II, or III trauma-related rehabilitative service.

"Designation" means a formal determination by the department that a hospital or health care facility is capable of providing designated trauma care services as authorized in RCW 70.168.070.

"Dispatch" means to designate and direct an emergency response unit to a service location.

"E-code" means external cause code, an etiology included in the International Classification of Diseases (ICD).

"ED" means emergency department.

"Emergency medical dispatch (EMD)" means provision of special procedures and trained personnel to ensure the efficient handling of medical emergencies and dispatch of aid. It includes prearrival instructions for CPR, mouth-to-mouth resuscitation and other verbal aid to callers.

"Emergency medical service (EMS)" means medical treatment and care which may be rendered at the scene of any medical emergency or while transporting any patient in an ambulance to an appropriate medical facility, including ambulance transportation between medical facilities.

"Emergency medical services and trauma care (EMS/TC) planning and services regions" means geographic areas established by the department in accordance with RCW 70.168.110.

"Emergency medical services and trauma care (EMS/TC) system" means an organized approach to providing personnel, facilities, and equipment for effective and coordinated medical treatment of patients with a medical emergency or injury requiring immediate medical or surgical intervention to prevent death or disability. The emergency medical service and trauma care system includes prevention activities, prehospital care, hospital care, and rehabilitation. The components of an EMS and trauma care system include:

- (1) Provision of manpower;
- (2) Training of personnel;
- (3) Communications;
- (4) Transportation;
- (5) Facilities;

- (6) Critical care units;
- (7) Use of public safety agencies;
- (8) Use of private agencies;
- (9) Consumer participation;
- (10) Accessibility to care;
- (11) Transfer of patients;
- (12) Standard medical record keeping and reporting;
- (13) Consumer information and education;
- (14) Independent review and evaluation, including formal quality assurance programs;
- (15) Disaster linkage; and
- (16) Mutual aid agreements.

"Emergency medical services and trauma care system plan (EMS/TC plan)" means a plan that identifies state-wide EMS/TC objectives and priorities and identifies equipment, facility, personnel, training, and other needs required to create and maintain a state-wide EMS/TC.

"Emergency medical technician (EMT)" means a person who is authorized by the secretary to render emergency medical care pursuant to RCW 18.73.081.

"EMS/TC" means emergency medical services and trauma care.

"EMT" means emergency medical technician.

"Facility patient care protocols" means the written procedures adopted by the medical staff that direct the care of the patient. These procedures shall be based upon the assessment of the patient's medical needs. The procedures shall follow minimum state-wide standards for trauma care service.

"First responder" means a person who is authorized by the secretary to render emergency medical care as defined by RCW 18.73.081.

"HIV/AIDS" means human immunodeficiency virus/acquired immunodeficiency syndrome.

"Hospital" means a facility licensed under chapter 70.41 RCW, or comparable health care facility operated by the federal government or located and licensed in another state.

"Hospital trauma service" means a service designed by the hospital within state guidelines for the treatment of trauma patients, including a formal commitment by the hospital and medical staff to an organized trauma care system and to participation in the regional/state system.

"ICD" means the international classification of diseases, a coding system developed by the World Health Organization.

"ICU" means intensive care unit.

"Indicator" means a quality improvement tool or performance measure used to monitor the quality of important governance, management, clinical, and support processes and outcomes.

"Indicator monitoring system" means a method in which indicators are used to monitor important processes or outcomes of care or service, and indicator data are used to evaluate that care.

"Injury prevention" means any combination of educational, legislative, enforcement, engineering and emergency response initiatives used to reduce the number and severity of injuries.

"IV technician" means a person certified to provide mobile intravenous therapy as defined in RCW 18.71.200(1).

"L&C" means licensing and certification.

"Legend drug" means any drug which is required by state law or regulation by the state board of pharmacy to be dispensed on prescription only, or is restricted to use by practitioners only.

"Level I pediatric rehabilitative services" means rehabilitative services as defined by RCW 70.168.015. Facilities providing level I pediatric rehabilitative services provide the same services as facilities authorized to provide level I rehabilitative services, except these services are exclusively for children under the age of fifteen years.

"Level I pediatric trauma care services" means pediatric trauma care services as defined by RCW 70.168.015. Hospitals providing level I services shall provide definitive, comprehensive, specialized care for pediatric trauma patients and shall also provide ongoing research and health care professional education in pediatric trauma care.

"Level II pediatric trauma care services" means pediatric trauma care services as defined by RCW 70.168.015. Hospitals providing level II services shall provide initial stabilization and evaluation of pediatric trauma patients and provide comprehensive general medical and surgical care to pediatric patients who can be maintained in a stable or improving condition without the specialized care available in the level I hospital. Complex surgeries and research and health care professional education in pediatric trauma care activities are not required.

"Level III pediatric trauma care services" means pediatric trauma care services as defined by RCW 70.168.015. Hospitals providing level III services shall provide initial evaluation and stabilization of patients.

The range of pediatric trauma care services provided in level III hospitals is not as comprehensive as level I and II hospitals.

"Level I rehabilitative services" means rehabilitative services as defined by RCW 70.168.015. Facilities providing level I rehabilitative services provide rehabilitative treatment to patients with traumatic brain injuries, spinal cord injuries, complicated amputations, and other diagnoses resulting in functional impairment, with moderate to severe impairment or complexity. These facilities serve as referral facilities for facilities authorized to provide level II and III rehabilitative services.

"Level II rehabilitative services" means rehabilitative services as defined by RCW 70.168.015. Facilities providing level II rehabilitative services treat individuals with musculoskeletal trauma, peripheral nerve lesions, lower extremity amputations, and other diagnoses resulting in functional impairment in more than one functional area, with moderate to severe impairment or complexity.

"Level III rehabilitative services" means rehabilitative services as defined by RCW 70.168.015. Facilities providing level III rehabilitative services provide treatment to individuals with musculoskeletal injuries, peripheral nerve injuries, uncomplicated lower extremity amputations, and other diagnoses resulting in functional impairment in more than one functional area but with minimal to moderate impairment or complexity.

"Level I trauma care services" means trauma care services as defined by RCW 70.168.015. Hospitals providing level I services shall have specialized trauma care teams and provide ongoing research and health care professional education in trauma care.

"Level II trauma care services" means trauma care services as defined by RCW 70.168.015. Hospitals providing level II services shall be similar to those provided by level I hospitals, although complex surgeries and research and health care professional education activities are not required to be provided. This does not exclude education or training of prehospital providers.

"Level III trauma care services" means trauma care services as defined by RCW 70.168.015. The range of trauma care services provided by level III hospitals are not as comprehensive as level I and II hospitals.

"Level IV trauma care services" means trauma care services as defined by RCW 70.168.015.

"Level V trauma care services" means trauma care services as defined by RCW 70.168.015. Facilities providing level V services shall provide stabilization and transfer of all patients with potentially life-threatening injuries.

"Licensing and certification committee (L&C committee)" means the emergency medical services licensing and certification advisory committee created by RCW 18.73.040.

"Local council" means a local EMS/TC council authorized by RCW 70.168.120(1).

"Local medical community" means the organized local medical society existing in a county or counties; or in the absence of an organized medical society, majority physician consensus in the county or counties.

"Medical control" means MPD authority to direct the medical care provided by all certified EMS personnel involved in patient care in the prehospital EMS system.

"Medical control agreement" means a written agreement between two or more MPD's, consistent with regional plans, to assure continuity of patient care between counties, and to facilitate assistance.

"Medical program director (MPD)" means an approved emergency medical services medical program director as defined by RCW 18.71.205(4).

"MPD" means medical program director.

"Name code" means the first four letters of the last name, followed by the first and middle initials.

"National uniform data set" means a coding system which describes the functional abilities and disabilities of the disabled person, published by the State University of New York, Buffalo, NY.

"Ongoing training and evaluation" means a course of education as authorized in RCW 18.73.081 (3)(b).

"PALS" means pediatric advanced life support, a course developed by the American Heart Association.

"Paramedic" means a person certified to provide mobile intensive care paramedic services as defined in RCW 18.71.200(3).

"Patient care procedures" means written operating guidelines adopted by the regional EMS/TC council, in consultation with local EMS/TC councils, emergency communications centers and the MPDs, in

accordance with state-wide minimum standards. The patient care procedures identify the level of medical care personnel to be dispatched to an emergency scene, procedures for triage of patients, the level of trauma care facility to first receive the patient, and the name and location of other trauma care facilities to receive the patient should an interfacility transfer be necessary. Procedures on interfacility transfer of patients shall be consistent with the transfer procedures in chapter 70.170 RCW.

"Pediatric trauma patient" means trauma patients known or estimated to be less than fifteen years of age.

"Physician" means an individual licensed under the provisions of chapter 18.71 RCW, Physicians, or under the provisions of chapter 18.57 RCW, Osteopathy.

"Practical examination" means a test which is conducted in the initial course, or a test or series of evaluations during a recertification period, wherein the competency of a person is determined on each of the practical skills specified by the department.

"Prehospital" means emergency medical care or transportation rendered to patients prior to hospital admission or during interfacility transfer by licensed ambulance or aid service under chapter 18.73 RCW, by personnel certified to provide emergency medical care under chapters 18.71 and 18.73 RCW, or by facilities providing level V trauma care services as provided for in chapter 18.71 RCW.

"Prehospital agencies" means both public and private providers of prehospital care or interfacility transport.

"Prehospital index" means a scoring system for hospital trauma team activation, incorporating assessment of systolic blood pressure, pulse, respiratory status, and level of consciousness, as described in "Prehospital Index: A scoring system for field triage of trauma victims", Koehler, John J., M.D. et al. *Annals of Emergency Medicine* 1986; 15:178-182.

"Prehospital patient care protocols" means the written procedures adopted by the MPD which direct the out-of-hospital emergency care of the emergency patient which includes the trauma care patient.

"Public education" means the use of preventive measures, involving the education of the population at large, targeted groups or individuals, and efforts to alter specific injury-related behaviors.

"Quality assurance (QA)" means an organized method of auditing and evaluating care provided within EMS/TC systems.

"Reciprocity" means the process by which an individual certified in another state, or certified by the university of Washington's school of medicine as authorized by RCW 18.71.200, is certified by the department.

"Region" means a geographic area used for EMS/TC planning, designated by the department in accordance with RCW 70.168.110.

"Regional council" means the regional EMS/TC council established by RCW 70.168.100.

"Regional plan" means the approved plan that identifies region-wide EMS/TC objectives and prioritizes and identifies equipment, facilities, personnel, training and other needs required to create and maintain a region-wide EMS/TC system. The plan includes a strategy of implementation that identifies regional and local activities to create, operate, maintain, and enhance the system.

"Registered nurse" means an individual licensed under the provisions of chapter 18.88 RCW.

"Rehabilitative services" means a formal program of multidisciplinary, coordinated, and integrated services for evaluation, treatment, education, and training to help individuals with disabling impairments achieve and maintain optimal functional independence in physical, psychosocial, social, vocational, and avocational realms.

"Reinstatement" means the process by which an individual whose EMS certification has expired can be recertified.

"Response area" means a service coverage zone identified in an approved regional plan.

"Rural" means unincorporated or incorporated areas with total populations less than 10,000 people, or with a population density of less than 1,000 people per square mile.

"Senior EMT instructor" means an individual approved to be responsible for the quality of instruction of an initial EMS training course.

"Specialized training" means approved training of certified EMS personnel to use a skill, technique or equipment that is not included in the standard course curriculum.

"State trauma registry" means data collected for examining the entire spectrum of trauma patients and their care, regardless of injury, hospital, or outcome.

"Steering committee" means the EMS/TC Steering committee created by RCW 70.168.020.

"Suburban" means an incorporated or unincorporated area with a population of 10,000 to 29,999 or any area with a population density of 1,000 to 2,000 people per square mile.

"System response time" for trauma means the time from an injury until the patient arrives at a designated trauma facility. It includes:

- (1) "System access time": The time from discovery to call received;
- (2) "E-911 time": The time it takes the call answer to:
  - (a) Process the call, including citizen interview; and
  - (b) Give the information to the dispatcher;
- (3) "Dispatch time": The time from call received by the dispatcher to the time the agency is notified;
- (4) "Activation time": The time from agency notification to start of response;
- (5) "Enroute time": The time it takes a unit to get to the scene;
- (6) "On scene time": The time the unit is on the scene with the patient. This includes extrication, resuscitation, treatment, and loading;
- (7) "Transport time": The time from leaving the scene to arrival at a health care facility;

"Training agency" means an organization or individual, which may include local or regional EMS/TC councils, that is approved to train EMS personnel for initial certification.

"Training physician" means a physician delegated by the MPD and approved by the department to be responsible for specified aspects of training of EMS personnel.

"Trauma" means a major single or multisystem injury requiring immediate medical or surgical intervention or treatment to prevent death or permanent disability.

"Trauma care system" means an organized approach to providing care to trauma patients that provides personnel, equipment and facilities for effective and coordinated trauma care. The trauma care system includes: Prevention, prehospital care, triage of trauma victims from the scene to designated trauma services, facilities with specific capabilities to provide trauma care, acute hospital care and rehabilitation services.

"Trauma rehabilitation coordinator" means a person designated to facilitate early rehabilitation interventions and the trauma patient's access to a designated rehabilitation center.

"Trauma surgeon" means a licensed physician who is board certified or board eligible in general surgery, and who has trauma surgery privileges delineated by the facility's medical staff credentials committee.

"Triage" means the sorting of patients in terms of disposition, destination, or priority. Triage of prehospital trauma victims requires identifying injury severity so that the appropriate care level can be readily assessed according to patient care guidelines.

"Unit of learning" means a method of meeting the CME requirements of this chapter, which includes:

- (1) Approved learning objectives that reflect a complete patient care approach and to a topic or group of related topics; and
- (2) Measures a student's comprehension of the subject matter by written testing and demonstration of skills.

"Urban" means:

- (1) An incorporated area over 30,000; or
- (2) An incorporated or unincorporated area of at least 10,000 people and a population density over 2,000 people per square mile.

"Verification" means the identification of prehospital providers capable of providing verified trauma care services, and is part of the licensure process described in chapter 18.73 RCW.

"Verified trauma care service" means prehospital services as provided for in RCW 70.168.080, and identified in the regional EMS/TC plan as required by RCW 70.168.100, whose capabilities have been verified by the department.

"Wilderness" means any rural area not readily accessible by private road.

## TRAINING

### NEW SECTION

WAC 246-976-020 FIRST RESPONDER TRAINING—COURSE CONTENTS, REGISTRATION, INSTRUCTOR QUALIFICATIONS. (1) For initial first responder training, the department shall recognize:

- (a) The U.S. Department of Transportation First Responder Training Course, as amended by the department; and

(b) Four hours of approved training in infectious disease prevention with special emphasis on HIV/AIDS and Hepatitis B, as required by chapter 70.24 RCW. Training shall be consistent with the curriculum manual KNOW – HIV/AIDS Prevention Education – an HIV/HSV Curriculum Manual for Emergency Medical Service Workers, published June 15, 1989, by the department's office on HIV/AIDS, or as amended by the department.

(2) The department shall establish and publish procedures for agencies conducting first responder training courses, including:

(a) The registration process;

(b) MPD responsibilities, including approval of course content and instructional personnel;

(c) Requirements, functions and responsibilities of course instructional and administrative personnel, including at least:

(i) A senior EMT instructor; or for first responder courses sponsored by fire service training, a fire service training endorsed first responder instructor; and

(ii) A course coordinator;

(d) Necessary administrative forms and information to conduct the course;

(e) Local EMS/TC council endorsement.

(3) Training agencies shall:

(a) Obtain written approval from the department to conduct each course;

(b) Approve or deny applicants for training consistent with requirements for certification, the regional plan, and recommendations of local EMS councils. Age of the applicant shall be at least eighteen years (or sixteen years with written recommendation from the MPD) at the beginning of the course;

(4) Training agencies or local councils may give fire department, prehospital and law enforcement personnel priority for admittance to the course.

(5) The department shall recognize county agencies established by ordinance and approved by the MPD to coordinate EMS training. Such agencies shall have the same responsibilities for selection of students and training as described in this section for the local EMS/TC councils.

#### NEW SECTION

WAC 246-976-025 FIRST RESPONDER—CONTINUING MEDICAL EDUCATION. (1) During each certification period a first responder shall complete a minimum of fifteen hours of MPD-approved CME, including:

(a) Annually:

(i) Two hours of CPR and airway management, including pediatrics;

(ii) One hour of patient medical extrication, including pediatric extrication and immobilization;

(iii) One hour of patient assessment, including pediatric assessment;

(b) During the current certification period:

(i) Two hours of approved training in infectious disease prevention with special emphasis on HIV/AIDS and Hepatitis B, to meet the requirements of chapter 70.24 RCW. Training shall be consistent with the curriculum manual Infectious Disease Prevention for EMS Providers – CME Disease Prevention Manual for Emergency Medical Service Personnel, published May 1991 by the department's office on HIV/AIDS, or as amended by the department;

(ii) One additional hour of CME on topics approved by the MPD;

(2) For one certification period only, the first responder may substitute hour-for-hour an approved trauma training course for any CME requirement, EXCEPT the CPR and HIV/AIDS requirements;

(3) With MPD approval, the first responder may substitute one approved unit of learning, as described in WAC 246-976-090, for two hours of required CME, EXCEPT the HIV/AIDS requirements.

#### NEW SECTION

WAC 246-976-030 EMERGENCY MEDICAL TECHNICIAN TRAINING—COURSE CONTENT, REGISTRATION, AND INSTRUCTOR QUALIFICATIONS. (1) For initial EMT training, the department shall recognize:

(a) The U.S. Department of Transportation Emergency Medical Technician training course as amended by the department; and

(b) Four hours of approved training in infectious disease prevention with special emphasis on HIV/AIDS and Hepatitis B, to meet the requirements of chapter 70.24 RCW. Training shall be consistent with the curriculum manual KNOW – HIV/AIDS Prevention Education – an HIV/HSV Curriculum Manual for Emergency Medical Service

Workers, published June 15, 1989 by the department's office on HIV/AIDS, or as amended by the department.

(2) The department shall establish and publish procedures for agencies conducting EMT training courses, including:

(a) The registration process;

(b) MPD responsibilities, including approval of course content and instructional personnel;

(c) Requirements, functions and responsibilities of course instructional and administrative personnel that include at least a course coordinator and senior EMT instructor;

(d) Necessary administrative forms and information to conduct the course; and

(e) Local EMS/TC council endorsement.

(3) Training agencies shall:

(a) Obtain written approval from the department to conduct each course;

(b) Approve or deny applicants for training consistent with requirements for certification, the regional plan, and recommendations of local EMS councils, including:

(i) Age of the applicant at least eighteen years at the beginning of the course;

(ii) High school diploma or GED;

(4) Training agencies or local councils may give fire department, prehospital and law enforcement personnel priority for admittance to the course.

(5) The department shall recognize any county agency established by ordinance to coordinate the EMS training responsibilities with local MPD approval. Such agency shall have the same responsibilities for selection of students and training as described in this section for the local EMS/TC councils.

#### NEW SECTION

WAC 246-976-035 EMERGENCY MEDICAL TECHNICIAN—CONTINUING MEDICAL EDUCATION. (1) During each certification period, an EMT shall complete a minimum of thirty hours of MPD-approved CME, including:

(a) Annually:

(i) Two hours of CPR and airway management, including pediatrics;

(ii) One hour of patient medical extrication, including pediatric extrication and immobilization;

(iii) One hour of patient assessment, including pediatric assessment;

(b) During the current certification period:

(i) Two hours of approved training in infectious disease prevention with special emphasis on HIV/AIDS and Hepatitis B, to meet the requirements of chapter 70.24 RCW. Training shall be consistent with the curriculum manual Infectious Disease Prevention for EMS Providers – CME Disease Prevention Manual for Emergency Medical Service Personnel, published May 1991 by the department's office on HIV/AIDS, or as amended by the department;

(ii) Two hours of pediatrics;

(iii) Fourteen additional hours of CME on topics approved by the MPD.

(2) For one certification period only, the EMT may substitute hour-for-hour an approved trauma training course for the CME requirements above, EXCEPT for the CPR and HIV/AIDS requirements.

(3) With MPD approval, the EMT may substitute one approved unit of learning, as described in WAC 246-976-090, for two hours of required CME, EXCEPT the HIV/AIDS requirement.

#### NEW SECTION

WAC 246-976-040 SPECIALIZED TRAINING. (1) The department shall establish and publish procedures for agencies conducting specialized training courses, including:

(a) The registration process;

(b) MPD and department approval of course curriculum and lesson plans, which shall be consistent with local patient care protocols;

(c) MPD and department approval of instructional personnel who are experienced and qualified in the area of training;

(d) Requirements, functions and responsibilities of course instructional and administrative personnel;

(e) Necessary administrative forms and information to conduct the course;

(2) Agencies conducting specialized training shall:

(a) Obtain written approval from the MPD and the department to conduct each course;

(b) Approve or deny applicants for training consistent with requirements for certification, the regional plan, and recommendations of local EMS councils;

(c) Have a written agreement with the clinical facility, if it is required for the course and is separate from the academic facility;

(d) Ensure that clinical facilities provide departments, sections, personnel and policies, including:

(i) Written program approval from the administrator and chief of staff;

(ii) A written agreement to participate in continuing education;

(iii) Supervised clinical experience for students during the clinical portion of the program;

(iv) An orientation program.

#### NEW SECTION

WAC 246-976-050 INTRAVENOUS THERAPY TECHNICIAN TRAINING—COURSE CONTENT, REGISTRATION, INSTRUCTOR QUALIFICATIONS. (1) For initial IV technician training, the department shall recognize those sections of the U.S. Department of Transportation Emergency Medical Technician – Intermediate course which relate to intravenous therapy, as amended by the department.

(2) The department shall establish and publish procedures for agencies conducting IV technician training courses, including:

(a) The registration process;

(b) MPD responsibilities, including approval of course content and instructional personnel;

(c) Requirements, functions and responsibilities of course instructional and administrative personnel;

(d) Necessary administrative forms and information to conduct the course;

(e) Local EMS/TC council endorsement.

(3) Training agencies shall:

(a) Obtain written approval from the department to conduct each course;

(b) Approve or deny applicants for training consistent with requirements for certification, the regional plan, and recommendations of local EMS Councils, including:

(i) Age of applicant at least eighteen years at the beginning of the course;

(ii) The applicant for training as an IV technician shall have a minimum of one year current experience as a certified EMT, unless a waiver is recommended in writing by the MPD;

(c) Have a written agreement with the clinical facility if it is separate from the academic facility;

(d) Ensure that clinical facilities provide departments, sections, personnel and policies, including:

(i) Written program approval from the administrator and chief of staff;

(ii) A written agreement to participate in continuing education;

(iii) Supervised clinical experience for students during the clinical portion of the program;

(iv) An orientation program.

(4) Training agencies or local councils may give fire department, prehospital and law enforcement personnel priority for admittance to the course.

(5) The department shall recognize county agencies established by ordinance and approved by the MPD to coordinate EMS training. Such agencies shall have the same responsibilities for selection of students and training as described in this section for the local EMS/TC councils.

#### NEW SECTION

WAC 246-976-055 INTRAVENOUS THERAPY TECHNICIANS—CONTINUING MEDICAL EDUCATION. (1) During each certification an IV technician shall complete a minimum of forty-five hours of MPD-approved CME, including:

(a) Annually:

(i) Two hours of CPR and airway management, including pediatrics;

(ii) One hour of patient medical extrication, including pediatric extrication and immobilization;

(iii) One hour of patient assessment, including pediatric assessment;

(b) During the current certification period:

(i) Two hours of approved training in infectious disease prevention with special emphasis on HIV/AIDS and Hepatitis B, to meet the requirements of chapter 70.24 RCW. Training shall be consistent with

the curriculum manual Infectious Disease Prevention for EMS Providers – CME Disease Prevention Manual for Emergency Medical Service Personnel, published May 1991 by the department's office on HIV/AIDS, or as amended by the department;

(ii) Two hours of pediatrics;

(iii) Twenty-nine additional hours of CME on topics approved by the MPD.

(2) For one certification period only, the IV technician may substitute hour-for-hour an approved trauma training course for the CME requirements above, EXCEPT the CPR and HIV/AIDS requirements.

(3) With MPD approval, the IV technician may substitute one approved unit of learning, as described in WAC 246-976-090, for two hours of required CME, EXCEPT the HIV/AIDS requirements.

#### NEW SECTION

WAC 246-976-060 AIRWAY TECHNICIAN TRAINING—COURSE CONTENT, REGISTRATION, INSTRUCTOR QUALIFICATIONS. (1) For initial airway technician training, the department shall recognize those sections of the U.S. Department of Transportation Emergency Medical Technician – Intermediate course which relate to airway management, as amended by the department.

(2) The department shall establish and publish procedures for agencies conducting airway technician training courses, including:

(a) The registration process;

(b) MPD responsibilities, including approval of course content and instructional personnel;

(c) Requirements, functions and responsibilities of course instructional and administrative personnel;

(d) Necessary administrative forms and information to conduct the course;

(e) Local EMS/TC council endorsement.

(3) Training agencies shall:

(a) Obtain written approval from the department to conduct each course;

(b) Approve or deny applicants for training consistent with requirements for certification, the regional plan, and recommendations of the local EMS Councils, including:

(i) Age of applicant at least eighteen years at beginning of course;

(ii) The applicant for initial training as an airway technician shall have a minimum of one year current experience as a certified EMT, unless a waiver is recommended in writing by the MPD;

(c) Have a written agreement with the clinical facility if it is separate from the academic facility;

(d) Ensure that clinical facilities provide departments, sections, personnel and policies, including:

(i) Written program approval from the administrator and chief of staff;

(ii) A written agreement to participate in continuing education;

(iii) Supervised clinical experience for students during the clinical portion of the program;

(iv) An orientation program.

(4) Training agencies or local councils may give fire department, prehospital and law enforcement personnel priority for admittance to the course.

(5) The department shall recognize county agencies established by ordinance and approved by the MPD to coordinate EMS training. Such agencies shall have the same responsibilities for selection of students and training as described in this section for the local EMS/TC councils.

#### NEW SECTION

WAC 246-976-065 AIRWAY TECHNICIAN—CONTINUING MEDICAL EDUCATION. (1) During each certification period the airway technician shall complete of a minimum of forty-five hours of MPD-approved CME, including:

(a) Annually:

(i) Two hours of CPR and airway management, including pediatrics;

(ii) One hour of patient medical extrication, including pediatric extrication and immobilization;

(iii) One hour of patient assessment, including pediatric assessment;

(b) During the current certification period:

(i) Two hours of approved training in infectious disease prevention with special emphasis on HIV/AIDS and Hepatitis B, to meet the requirements of chapter 70.24 RCW. Training shall be consistent with

the curriculum manual Infectious Disease Prevention for EMS Providers - CME Disease Prevention Manual for Emergency Medical Service Personnel, published May 1991 by the department's office on HIV/AIDS, or as amended by the department;

- (ii) Two hours of pediatrics;
- (iii) Twenty-nine additional hours of CME on topics approved by the MPD.

(2) For one certification period only, the airway technician may substitute hour-for-hour an approved trauma training course for the CME requirements above, EXCEPT the CPR and HIV/AIDS requirements.

(3) With MPD approval, the airway technician may substitute one approved unit of learning, as described in WAC 246-976-090, for two hours of required CME, EXCEPT the HIV/AIDS requirements.

#### NEW SECTION

WAC 246-976-070 COMBINED INTRAVENOUS THERAPY AND AIRWAY TECHNICIAN TRAINING—COURSE CONTENT, REGISTRATION, INSTRUCTOR QUALIFICATIONS.

(1) For initial airway and IV therapy training, the department shall recognize those sections of the U.S. Department of Transportation Emergency Medical Technician - Intermediate course which relate to airway management and IV therapy, as amended by the department.

(2) The department shall establish and publish procedures for agencies conducting IV therapy and airway technician training courses, including:

- (a) The registration process;
- (b) MPD responsibilities, including approval of course content and instructional personnel;
- (c) Requirements, functions and responsibilities of course instructional and administrative personnel;
- (d) Necessary administrative forms and information to conduct the course;
- (e) Local EMS/TC council endorsement.

(3) Training agencies shall:

(a) Obtain written approval from the department to conduct each course;

(b) Approve or deny applicants for training consistent with requirements for certification, the regional plan, and recommendations of local EMS councils, including:

- (i) Age of applicant at least eighteen years at the beginning of the course;
- (ii) The applicant for initial training as a combined IV therapy technician and airway technician shall have a minimum of one year current experience as a certified EMT, unless a waiver is recommended in writing by the MPD;
- (c) Have a written agreement with the clinical facility if it is separate from the academic facility;
- (d) Ensure that clinical facilities provide departments, sections, personnel and policies, including:

- (i) Written program approval from the administrator and chief of staff;
- (ii) A written agreement to participate in continuing education;
- (iii) Supervised clinical experience for students during the clinical portion of the program;
- (iv) An orientation program.

(4) Training agencies or local councils may give fire department, prehospital and law enforcement personnel priority for admittance to the course.

(5) The department shall recognize county agencies established by ordinance and approved by the MPD to coordinate EMS training. Such agencies shall have the same responsibilities for selection of students and training as described in this section for the local EMS/TC councils.

#### NEW SECTION

WAC 246-976-075 IV THERAPY/AIRWAY TECHNICIAN—CONTINUING MEDICAL EDUCATION. (1) During each certification period, an individual holding dual certification as both an IV technician and an airway technician shall complete a minimum of sixty hours of MPD-approved CME, including:

- (a) Annually:
  - (i) Two hours of CPR and airway management, including pediatrics;
  - (ii) One hour of patient medical extrication, including pediatric extrication and immobilization;
  - (iii) One hour of patient assessment, including pediatric assessment;

(b) During the current certification period:

(i) Two hours of approved training in infectious disease prevention with special emphasis on HIV/AIDS and Hepatitis B, to meet the requirements of chapter 70.24 RCW. Training shall be consistent with the curriculum manual Infectious Disease Prevention for EMS Providers - CME Disease Prevention Manual for Emergency Medical Service Personnel, published May 1991 by the department's office on HIV/AIDS, or as amended by the department;

(ii) Two hours of pediatrics;

(iii) Forty-four additional hours of CME on topics approved by the MPD.

(2) For one certification period only, the combined IV and airway technician may substitute hour-for-hour an approved trauma training course for the CME requirements above, EXCEPT for the CPR and HIV/AIDS requirements.

(3) With MPD approval, the combined IV and airway technician may substitute one approved unit of learning, as described in WAC 246-976-090, for two hours of required CME, EXCEPT for the HIV/AIDS requirements.

#### NEW SECTION

WAC 246-976-080 PARAMEDIC TRAINING—COURSE CONTENT. (1) For initial paramedic training, the department shall recognize the current U.S. Department of Transportation Emergency Medical Technician - Paramedic National Standard Course, as amended by the department.

(2) The department shall establish and publish procedures for agencies conducting paramedic training courses, including:

- (a) The registration process;
- (b) MPD responsibilities, including approval of course content and instructional personnel;
- (c) Requirements, functions and responsibilities of course instructional and administrative personnel;
- (d) Necessary administrative forms and information to conduct the course;
- (e) Local EMS/TC council endorsement.

(3) Paramedic training agencies shall:

(a) By July 1, 1995, be accredited by the committee on allied health education and accreditation;

(b) Obtain written approval from the department to conduct each course;

(c) Approve or deny applicants for training consistent with requirements for certification, the regional plan, and recommendations of local EMS Councils, including:

- (i) Age of the applicant at least eighteen years at the beginning of the course;
- (ii) The applicant for training as a paramedic shall have a minimum of one year current experience as a certified EMT, unless a waiver is recommended in writing by the MPD;
- (d) Have a written agreement with the clinical facility if it is separate from the academic facility;
- (e) Ensure that clinical facilities provide departments, sections, personnel and policies, including:

- (i) Written program approval from the administrator and chief of staff;
- (ii) A written agreement to participate in continuing education;
- (iii) Supervised clinical experience for students during the clinical portion of the program;
- (iv) An orientation program.

(4) Training agencies or local councils may give fire department, prehospital and law enforcement personnel priority for admittance to the course.

(5) The department shall recognize county agencies established by ordinance and approved by the MPD to coordinate EMS training. Such agencies shall have the same responsibilities for selection of students and training as described in this section for the local EMS/TC councils.

#### NEW SECTION

WAC 246-976-085 PARAMEDIC—CONTINUING MEDICAL EDUCATION. (1) During each certification period, a paramedic shall document completion of a minimum of one hundred fifty hours of MPD-approved CME, including:

(a) Two hours of approved training in infectious disease prevention with special emphasis on HIV/AIDS and Hepatitis B, to meet the requirements of chapter 70.24 RCW. Training shall be consistent with



the curriculum manual Infectious Disease Prevention for EMS Providers - CME Disease Prevention Manual for Emergency Medical Service Personnel, published May 1991 by the department's office on HIV/AIDS, or as amended by the department;

(b) Six hours of pediatrics;

(c) One hundred forty-two additional hours of CME on topics approved by the MPD;

(2) With MPD approval, the paramedic may substitute one approved unit of learning, as described in WAC 246-976-090, for two hours of required CME, EXCEPT for the HIV/AIDS requirements.

#### NEW SECTION

WAC 246-976-090 CONTINUING MEDICAL EDUCATION—UNITS OF LEARNING. (1) The department shall approve units of learning which:

(a) Have defined objectives reflecting minimum knowledge and performance requirements appropriate to the category and subject, including at least:

(i) Patient assessment and treatment skills;

(ii) Extrication and patient handling;

(iii) Pediatric, geriatric, and other special patient care needs;

(b) Include evaluation of knowledge and skill performance identified in the learning objectives, through both written assessment and practical application.

(2) Training agencies offering units of learning for CME shall:

(a) Have MPD approval of lesson plans and evaluation tools;

(b) Require students to demonstrate knowledge and skill performance to meet the approved objectives, without specific hour requirements. If demonstration of knowledge and skills is unsatisfactory, remedial training shall be completed before additional attempts are allowed.

#### NEW SECTION

WAC 246-976-110 SENIOR EMT INSTRUCTOR—QUALIFICATIONS AND RESPONSIBILITIES. (1) The department shall establish and publish procedures for the recognition and renewal of recognition for senior EMT instructors and course coordinators.

(2) For initial recognition by the department as a senior EMT instructor, an applicant shall submit to the department proof of:

(a) High school graduation or GED;

(b) Current EMS certification with a minimum of three years experience at the EMT level or above. The department may waive this requirement if the applicant has:

(i) A minimum of three years prehospital EMS experience; and

(ii) Recommendation for waiver from the MPD;

(c) Certification as a CPR instructor by the American Heart Association or American Red Cross;

(d) Successful completion of an approved instructor workshop;

(e) Experience assisting with two EMT courses, performing a minimum of three hours of lectures and six hours of practical skills in each course;

(f) Recommendation from:

(i) An MPD or delegate; and

(ii) A fire chief, another senior EMT instructor, or EMS faculty person;

(g) The recommendation of the MPD; and

(h) The recommendation of the Local EMS/TC council; and

(3) To maintain recognition, a senior EMT instructor shall renew written approval from the MPD and the local EMS/TC council every three years.

(4) The senior EMT instructor shall:

(a) Be responsible for the overall instructional quality of the course;

(b) Counsel students as needed.

#### NEW SECTION

WAC 246-976-115 COURSE COORDINATOR—RESPONSIBILITIES. (1) The course coordinator shall:

(a) Submit the course application to the department for approval;

(b) Schedule course times, locations, and instructors;

(c) Schedule approved written, oral or practical certification examinations;

(d) Submit all required documentation to the department;

(e) A course coordinator who is also the lead instructor for a course shall meet all senior EMT instructor requirements described in this chapter.

#### NEW SECTION

WAC 246-976-120 DISCIPLINARY ACTION—TRAINING PERSONNEL. (1) The department may take disciplinary action against senior EMT instructors and course coordinators, for reasons which include but are not limited to:

(a) Falsification of any documents associated with the course of instruction, evaluation, or examination;

(b) Compromise of the department's examination process;

(c) Failure to provide required information to the department, the MPD or other training and testing personnel as appropriate; or

(d) Failure to properly complete departmental forms and procedures.

(2) Disciplinary action may include but is not limited to:

(a) Withdrawal of authority to participate in EMS/TC training and/or testing;

(b) Revocation, modification, or suspension of certification, if the individual holds EMS certification.

#### CERTIFICATION

#### NEW SECTION

WAC 246-976-140 CERTIFICATION AND RECERTIFICATION—GENERAL REQUIREMENTS. (1) The department shall establish and publish procedures for initial certification which include:

(a) Written and practical examinations for:

(i) First responders;

(ii) EMTs

(iii) IV technicians;

(iv) Airway technicians;

(v) Paramedics;

(b) The process for administration of written and practical examinations;

(c) Administrative requirements and the necessary forms.

(2) The department shall establish and publish procedures for renewal of certification which include:

(a) The process for ongoing training and evaluation of skills for first responders and EMTs;

(b) Written and practical examinations for renewal of certification.

(3) Applicants for initial certification shall submit to the department:

(a) An application for certification of forms provided by the department;

(b) Proof of identity: A valid driver's license or other photo identification;

(c) Proof of age;

(c) Proof of completion of an approved course or courses of instruction for the level of certification sought, as described in this chapter;

(d) Proof of completion of four hours of initial HIV/AIDS training, as described in this chapter;

(e) Proof of successful completion of approved written and practical examinations within the six months prior to application. Applicants shall be allowed no more than three attempts to successfully complete the written and practical examinations;

(f) Proof of active membership, paid or volunteer, in one of the following EMS/TC organizations:

(i) Fire department or district;

(ii) Licensed provider of aid or ambulance services;

(iii) Law enforcement agency; or

(iv) Other affiliated EMS/TC service;

(g) Recommendation by the MPD for certification;

(h) Other information required by this chapter.

(4) Certification shall be effective on the date the department issues the certificate, and shall be valid for a period of three years. The expiration date shall be indicated on the certification card.

(5) Applicants for renewal of certification shall submit to the department on approved forms:

(a) All the information identified in subsection (3) of this section; EXCEPT, current certification shall be deemed proof of course completion, age, and initial HIV/AIDS training;

(b) Proof of completion of CME required for the level of certification sought, as defined in this chapter;

(c) Proof of maintenance of skills required for the level of recertification sought, as defined in this chapter;

(d) For first responders and EMTs, proof of successful demonstration of skills, by:



(i) Successful completion of an approved program of ongoing training and evaluation. An applicant changing from the practical examination program to the on-going training and evaluation program shall do so before a second attempt at the practical examination; or

(ii) Passing an approved practical examination within the six months prior to application. An applicant changing from the on-going training and evaluation program to the practical examination program shall do so by taking the practical examination prior to the end of the certification period;

(e) For IV technicians, airway technicians, or paramedics, proof that proficiency of skills has been demonstrated to the satisfaction of the MPD.

(6) Certification of IV technicians, airway technicians, and paramedics under this chapter shall be valid only:

(a) In the county or counties where approved by an MPD, as indicated on the certification card;

(b) In other counties where formal EMS/TC medical control agreements are in place; or

(c) In other counties when accompanying a patient in transit from a county meeting the criteria in (a) or (b) of this subsection.

**Reviser's note:** The typographical error in the above section occurred in the copy filed by the agency and appears in the Register pursuant to the requirements of RCW 34.08.040.

#### NEW SECTION

WAC 246-976-150 CERTIFICATION AND RECERTIFICATION—FIRST RESPONDER. (1) In addition to meeting the requirements of WAC 246-976-140(3), the applicant for initial certification as a first responder shall submit documentation to the department of:

(a) Successful completion of a first responder course as described in WAC 246-976-020(1);

(b) Age, which shall be at least eighteen years, or at least sixteen years of age with written recommendation of the MPD.

(2) In addition to meeting the requirements of WAC 246-976-140(5), a currently certified First Responder applying for recertification shall document completion during the current certification period of CME requirements described in WAC 246-976-025.

#### NEW SECTION

WAC 246-976-160 CERTIFICATION AND RECERTIFICATION—EMERGENCY MEDICAL TECHNICIAN. (1) In addition to meeting the requirements of WAC 246-976-140(3), the applicant for initial certification as an EMT shall submit documentation to the department of:

(a) Successful completion of an EMT course as described in WAC 246-976-030(1);

(b) Age, which shall be at least eighteen years;

(c) High school graduation or GED.

(2) In addition to meeting the requirements of WAC 246-976-140(5), a currently certified EMT applying for recertification shall document completion during the current certification period of the CME requirements described in WAC 246-976-035.

#### NEW SECTION

WAC 246-976-170 CERTIFICATION AND RECERTIFICATION—INTRAVENOUS THERAPY TECHNICIANS. (1) In addition to meeting the requirements of WAC 246-976-140(3), the applicant for initial certification as an IV technician shall submit documentation to the department of:

(a) Successful completion of an IV technician course as described in WAC 246-976-050(1);

(b) Current certification as an EMT, with a minimum of one year of active affiliation as an EMT with an EMS/TC provider;

(2) In addition to meeting the requirements of WAC 246-976-140(5), a currently certified IV technician applying for recertification shall submit to the department documentation of:

(a) Completion of the CME requirements described in WAC 246-976-055;

(b) Skills that have been maintained as follows:

(i) Annually, during the initial certification period:

(A) A minimum of thirty-six catheter-around-needle insertions performed on sick, injured, or preoperative adult and pediatric patients, or on artificial training aids with approval of the MPD;

(B) Proficiency in intraosseous line placement in pediatric patients, demonstrated to the satisfaction of the MPD;

(ii) In subsequent certification periods, proficiency in intravenous and intraosseous line placement, demonstrated to the satisfaction of the MPD.

#### NEW SECTION

WAC 246-976-180 CERTIFICATION AND RECERTIFICATION—AIRWAY TECHNICIANS. (1) In addition to meeting the requirements of WAC 246-976-140(3), the applicant for initial certification as an airway technician shall submit to the department documentation of:

(a) Successful completion of an airway management course as described in WAC 246-976-060(1);

(b) Current certification as an EMT or above, with a minimum of one year of active affiliation as an EMT with an EMS/TC provider;

(2) In addition to meeting the requirements of WAC 246-976-140(5), a currently certified airway technician applying for recertification shall submit to the department documentation of:

(a) Completion of the CME requirements described in WAC 246-976-065;

(b) Skills that have been maintained as follows:

(i) Annually, during the initial certification period, a minimum of twelve endotracheal intubations, at least six of which must be performed on human subjects; with written authorization of the MPD, no more than six of the intubations may be performed on artificial training aids;

(ii) In subsequent certification periods:

(A) Annually, a minimum of four endotracheal intubations, at least two of which must be performed on human subjects; with written authorization of the MPD, no more than two of the intubations may be performed on artificial training aids; and

(B) Proficiency in pediatric airway management, demonstrated to the satisfaction of the MPD.

#### NEW SECTION

WAC 246-976-190 RECERTIFICATION—IV AND AIRWAY TECHNICIANS. In addition to meeting the requirements of WAC 246-976-140(5), an individual currently certified as both an IV and an airway technician, who is applying for recertification in both skills, shall submit to the department documentation of:

(1) Completion of the skills maintenance requirements for IV technicians described in WAC 246-976-170 (2)(b);

(2) Completion of the skills maintenance requirements for airway technicians described in WAC 246-976-180 (2)(b);

(3) Completion during the current certification period of the CME requirements described in WAC 246-976-075.

#### NEW SECTION

WAC 246-976-200 CERTIFICATION AND RECERTIFICATION—PARAMEDICS. (1) In addition to meeting the requirements of WAC 246-976-140(3), an applicant for initial certification as a Paramedic shall submit to the department documentation of successful completion of a paramedic course as described in WAC 246-976-800(1).

(2) In addition to meeting the requirements of WAC 246-976-140(5), a currently certified paramedic applying for recertification shall submit to the department documentation of:

(a) Completion of the skills maintenance requirements for IV technicians described in WAC 246-976-170 (2)(b);

(c) Completion of the skills maintenance requirements for airway technicians described in WAC 246-976-180 (2)(b).

#### NEW SECTION

WAC 246-976-210 CERTIFICATION—RECIPROCITY, CHALLENGES, AND REINSTATEMENT. (1) The department shall establish and publish procedures for:

(a) Reciprocal certification of individuals with current EMS certification in another state, and who are recognized by the National Registry;

(b) Reinstatement of individuals whose EMS/TC certification has expired;

(c) Challenge of prerequisites for certification examinations by individuals who have not completed the course work and practical training

required by this chapter, but who document equivalent EMS training and/or experience;

(2) Before granting reciprocity, reinstatement, or challenge, the department shall insure that HIV/AIDS training required for EMS/TC personnel by chapter 70.24 RCW has been accomplished.

#### NEW SECTION

WAC 246-976-220 EMS PERSONNEL—SCOPE OF CARE AUTHORIZED, PROHIBITED. (1) Certified EMS/TC personnel are authorized to provide only:

(a) Services within the scope of training as contained in the approved course curriculum for the level of certification; and

(b) Services within the scope of approved specialized training as described WAC 246-976-040.

(2) Certified EMS/TC personnel are authorized to provide treatment for patients in prehospital emergency situations and during patient transport, following MPD-approved patient care protocols.

#### NEW SECTION

WAC 246-976-230 CERTIFICATION—REVERSION, REVOCATION, SUSPENSION, MODIFICATION, OR DENIAL. (1) The department shall establish and publish procedures:

(a) To allow an individual to revert from a level of certification to a lower level of certification;

(b) To investigate complaints and allegations against certified personnel;

(c) For corrective action by MPDs regarding certified individuals.

(2) The uniform disciplinary act, chapter 18.130 RCW, governs uncertified practice, the issuance and denial of certificates, and the disciplining of certificate holders under this chapter. The secretary is authorized by RCW 18.130.040 to be the disciplining authority under this chapter. Disciplinary action shall be initiated against a person credentialed under this chapter in a manner consistent with the responsibilities and duties of the MPD under whom such person is responsible.

(3) The department may revoke, suspend, or modify certificates of, or deny certificates to individuals who have:

(a) Provided false information to obtain the certificate;

(b) Performed duties or skills outside of the scope of practice;

(c) Misrepresented their level of certification;

(d) Falsified records of patient care;

(e) Demonstrated incompetence, negligence, malpractice, or otherwise an inability or unwillingness to provide adequate service;

(f) Violated provisions of chapters 18.71, 18.73 or 70.168 RCW, or of this chapter;

(g) Had a professional license revoked, suspended, or denied under Washington state professional licensing statutes;

(h) Demonstrated unprofessional conduct in the course of providing services, including:

(i) The possession, use, prescription for use, or distribution of controlled substances or legend drugs in any way other than for legitimate or therapeutic purposes;

(ii) Diversion of controlled substances or legend drugs;

(iii) The violation of any drug law;

(iv) Prescribing controlled substances for oneself;

(v) Current misuse of:

(A) Alcohol;

(B) Controlled substances; or

(C) Legend drugs;

(vi) Abuse of a client or patient; or

(vii) Sexual contact with a client or patient;

(i) Violated written patient care protocols which the certified individual has acknowledged in writing;

(j) Failed to maintain skills or continuing education according to standards set forth in this chapter;

(k) Failed to demonstrate to the MPD and the department continuing knowledge and overall ability to successfully manage patients with medical or traumatic emergencies;

(l) Failed to cooperate or interfered with the MPD and the department in any investigation regarding medical performance or professional conduct;

(m) Failed to cooperate with the MPD and/or the department in the attempt to initiate corrective action pursuant to this chapter, which may include counseling;

(n) Been convicted of a felony;

(o) Been decertified for cause by out of state authorities;

(p) Not successfully completed the ongoing training and evaluation program;

(q) Failed the written or practical examination;

(4) Before recommending revocation, suspension, modification or denial of a certificate, the MPD shall initiate corrective action with the certified individual, consistent with department procedures.

(5) The MPD may request the department to summarily suspend certification of an individual if the MPD believes that continued certification will be detrimental to patient care.

(6) In cases where the MPD recommends denial of recertification, the department:

(a) Shall investigate the individual;

(b) May revoke the certification.

(7) Except in the case of summary action as provided in subsection (5) of this section, any action by the department shall be in accordance with WAC 246-976-240.

(8) If an employing or sponsoring agency disciplines a certified individual for conduct as described in this section, the agency shall report the cause and the action taken to the department.

#### NEW SECTION

WAC 246-976-240 NOTICE OF DECISION AND HEARING. The department shall establish and publish procedures for the conduct of modification, suspension, revocation, or denial of certification, which shall be consistent with the requirements of the Administrative Procedure Act, the Uniform Disciplinary Act, chapter 34.05 RCW, and chapter 246-08 WAC.

### LICENSURE

#### NEW SECTION

WAC 246-976-260 LICENSES REQUIRED. (1) The department shall:

(a) Establish and publish procedures for licensure of ambulance and aid services and ambulance and aid vehicles, consistent with the state and regional plans;

(b) Not allow the transfer of licenses issued under this chapter.

(2) Applicants for licensure as ambulance or aid services shall submit application to the department following department procedures, including:

(a) Evidence of ability to comply with standards, rules, and regulations of this chapter;

(b) Evidence of operation that is consistent with the state-wide and regional EMS/TC plans and prehospital patient care procedures;

(c) Evidence of liability insurance coverage;

(d) Description of the general area to be served and the number of vehicles to be used.

(3) Licensees shall submit application for renewal of licensure to the department at least thirty days before the expiration of the current license.

#### NEW SECTION

WAC 246-976-270 DENIAL, SUSPENSION, REVOCATION OF LICENSE—NOTICE, HEARING. (1) Under the provisions of the Administrative Procedure Act, chapter 34.05 RCW, and chapter 246-08 WAC, the department may suspend, modify or revoke any ambulance or aid vehicle license issued under this chapter, or deny licensure to an applicant, when it finds failure to comply with the requirements of chapter 18.73 RCW, or other applicable laws or rules, or with this chapter.

(2) The Uniform Disciplinary Act, chapter 18.130 RCW, governs the unlicensed practice, the issuance and denial of licenses, and the disciplining of persons who hold licenses to operate ambulance or aid services under this chapter. The secretary is authorized by RCW 18.130.040 to be the disciplining authority under this chapter. The department may suspend, modify or revoke any ambulance or aid service license issued under this chapter, or deny licensure to an applicant when it finds:

(a) Failure to comply with the requirements of chapters 18.71, 18.73, or 70.168 RCW, or other applicable laws or rules, or with this chapter;

(b) False, fraudulent, or misleading advertising, or any public claim of authorization to provide a level of service for which the licensee is not authorized or licensed;

(c) Failure to comply with approved patient care protocols or procedures;

(d) Failure to cooperate with the department in inspections or investigations;

(e) Failure to supply data as required in chapter 70.168 RCW and this chapter.

(3) Licensees or applicants may request a hearing to contest department decisions on license denial, suspension, modification or revocation by filing a written application in accordance with WAC 246-08-020.

(4) Under the provisions of the administrative procedures act, and the uniform disciplinary act, the department may impose sanctions against a licensed service which has not been verified under this chapter, but which routinely responds to trauma incidents and/or renders care to patients of trauma in a manner that is not consistent with the approved regional plan. Such sanctions may include but are not limited to action under RCW 18.73.190 and this chapter which may lead to revocation of the service's license, assessment of fines, and/or filing of misdemeanor charges.

(a) The department shall not take action against a licensed, nonverified service under this section for providing emergency trauma care when wait for arrival of a verified service would place the life of the patient in jeopardy.

(b) This section shall not restrict the authority of a provider licensed under chapter 18.73 RCW to provide services which it has been authorized to provide by state law, EXCEPT as addressed by chapter 70.168 RCW and specified in the approved regional plan.

#### NEW SECTION

WAC 246-976-280 AMBULANCE AND AID SERVICES—PERSONNEL REQUIREMENTS. (1) Aid services shall provide each aid vehicle with at least one person currently trained in advanced first aid or certified as a first responder.

(2) Ambulance services shall provide each ambulance with sufficient personnel for adequate patient care, including a minimum of one EMT and one person with advanced first aid training or first responder certification;

(a) The person with the highest level of EMS certification shall be in charge of patient care;

(b) The driver of the ambulance shall have a minimum of advanced first aid training or first responder certification; EXCEPT, if there are at least two certified EMTs in attendance of the patient the driver shall not be required to have advanced first aid training or first responder certification.

#### NEW SECTION

WAC 246-976-290 AMBULANCE VEHICLE STANDARDS.

(1) All ambulance vehicles shall be clearly identified by appropriate emblems and markings on the front, side and rear of the vehicle.

(2) Tires, spare tire, tire changing tools shall meet the following requirements:

(a) Tires shall be in good condition with not less than two-thirty-seconds inch useable tread, appropriately sized to support the weight of the vehicle when loaded;

(b) One inflated spare tire shall be furnished and stored in a protected area which provides access without removal of the patient;

(c) Tire changing tools shall be furnished. Minimum tools shall include a jack, jack handle, and wheel-nut wrench. The jack shall be capable of raising any wheel of the loaded ambulance to an adequate height.

(3) The electrical system shall meet the following requirements:

(a) Interior lighting in the driver compartment shall be designed and located so that no glare is reflected from surrounding areas to the driver's eyes or line of vision from the instrument panel, switch panel, or other areas which may require illumination while the vehicle is in motion;

(b) Interior lighting in the patient compartment shall be adequate throughout the compartment, and provide an intensity of twenty foot-candles at the level of the patient. Lights should be controllable from the patient compartment and the driver compartment;

(c) Exterior lights shall comply with the appropriate sections of Federal Motor Vehicle Safety Standards, and include body-mounted flood lights over the rear door which provide adequate loading visibility;

(d) Emergency warning lights shall be provided in accordance with RCW 46.37.380, as administered by the state commission on equipment.

(4) Windshield wipers and washers shall be dual, electric, multispeed, and maintained in good condition.

(5) Battery and generator system:

(a) The battery shall have a minimum seventy ampere hour rating. It must be located in a ventilated area sealed off from the vehicle interior, and completely accessible for checking and removal;

(b) The generating system shall be capable of supplying the maximum built-in DC electrical current requirements of the ambulance. Extra fuses shall be provided.

(6) Seat belts shall comply with Federal Motor Vehicle Safety Standards 207, 208, 209 and 210. Restraints shall be provided in all seat positions in the vehicle, including the attendant station.

(7) Mirrors shall be provided on the left side and right side of the vehicle. The location of mounting must be such as to provide maximum rear vision from the driver's seated position. There may be an interior rear-view mirror to provide the driver with a view of occurrences in the patient compartment.

(8) One ABC two and one-half pound fire extinguisher shall be provided.

(9) Ambulance body:

(a) The length of the patient compartment shall be at least 112 inches in length, measured from the partition to the inside edge of the rear loading doors. This length shall provide at least twenty inches, and not more than thirty inches, of unobstructed space at the head of the primary patient, measured from the technician's seat back rest to the forward edge of the cot;

(b) The width of the patient compartment, after cabinet and cot installation, shall provide at least nine inches of clear walkway between cots or the squad bench. The department recommends at least twenty-five inches width of kneeling space alongside the primary cot be provided, measured at the floor for a height of nine inches, from the forward leading edge, half of the length back of the primary cot;

(c) The height of the patient compartment shall be at least fifty-three inches at the center of the patient area, measured from floor to ceiling, exclusive of cabinets or equipment;

(d) There shall be secondary egress from the curb side of the patient compartment;

(e) The back doors shall open in a manner to increase the width for loading patients without blocking existing working lights of the vehicle;

(f) Steps may be provided at door openings if the floor is more than eighteen inches above the ground. Steps shall be of a design to prevent the accumulation of mud, ice or snow, and shall have a nonskid surface;

(g) The floor shall be at the lowest level permitted by clearances. It shall be flat and unencumbered in the access and work area. There shall be no voids or pockets in the floor to side wall areas where water or moisture can become trapped to cause rusting and/or unsanitary conditions;

(h) Floor covering shall be applied to the top side of the floor surface. It shall withstand washing with soap and water or disinfectant without damage to the surface. All joints in the floor covering shall have minimal void between matching edges and shall be cemented with a suitable water- and chemical-proof cement to eliminate the possibility of joints loosening or lifting;

(i) The department recommends all interior fasteners, latches, hinges, etc. should be of a flush-type design. When doors are open, the hinges, latches, and door checks shall not protrude into the access area. All hangers or supports for equipment or other items should be flush with the surrounding surface when not in use. The finish of the entire patient compartment shall be impervious to soap and water and disinfectants to permit washing and sanitizing;

(j) Exterior surfaces shall be smooth, with appurtenances kept to a minimum;

(k) Restraints shall be provided for all litters. If the litter is floor supported on its own support wheels, a means shall be provided to secure it in position. These restraints shall permit quick attachment and detachment for quick transfer of patient.

(10) Vehicle brakes, tires, regular and special electrical equipment, windshield wipers, heating and cooling units, safety belts, and window glass, shall be in good working order.

**Reviser's note:** The typographical error in the above section occurred in the copy filed by the agency and appears in the Register pursuant to the requirements of RCW 34.08.040.

**NEW SECTION**

AMBULANCE AID VEHICLE

WAC 246-976-300 AMBULANCE AND AID VEHICLES—EQUIPMENT. Ambulance and aid services shall provide minimum equipment on each licensed vehicle, including:

	AMBULANCE	AID VEHICLE
<b>AIRWAY MANAGEMENT</b>		
Airway Adjuncts		
Oral airway (adult: sm, med, lg)	1ea	1ea
Oral airway (pediatric: 00,0,1,2,3,4)	1ea	1ea
Suction		
Portable, manual	1	1
Vehicle mounted	1	0
Tubing	1	1
Bulb syringe, pediatric	1	1
Catheter		
Adult (14 Fr x 22")	4	2
Pediatric (6, 8, 10 Fr)	1ea	1ea
Rigid suction tips	2	1
Water, rinsing	Yes	0
Oxygen delivery		
Oxygen cylinder (3000L, 500PSI min)	1	0
Oxygen cylinder (300L, 500PSI min)	2	1
Regulator, oxygen (0-15+ Liter)	1	1
Cannula, nasal, adult	4	2
O <sub>2</sub> mask, adult	4	2
O <sub>2</sub> mask, pediatric	2	1
O <sub>2</sub> mask, nonrebreather, adult	4	2
O <sub>2</sub> mask, nonrebreather, pediatric	2	1
BVM, with O <sub>2</sub> reservoir		
adult	1	0
Pediatric (with 00, 1, 2 masks)	1	0
Pocket mask or equivalent	0	1
<b>PATIENT ASSESSMENT AND CARE</b>		
Assessment		
Sphygmomanometer		
Adult, large	1	0
Adult, regular	1	1
Pediatric	1	0
Infant	1	0
Stethoscope		
Adult	1	1
Pediatric	1	0
Thermometer, oral, hypothermia	1ea	0
Flashlight, w/spare batteries & bulb	1	1
Personal infection control		
Gloves, exam, nonsterile (box)	1	1
Other equipment per WISHA requirements	Yes	Yes
<b>MEDICAL EMERGENCIES</b>		
Wound care		
Dressing, sterile	asst	asst
Dressing, sterile, trauma	6	4
Roller gauze bandage	asst	asst
Triangular bandage	4	4
Medical tape	asst	asst
Self adhesive bandage strips	asst	asst
Cold packs	4	2
Occlusive dressings	2	2
Burn sheets	2	2
Scissors, bandage	1	1
Irrigation solution	2	1
Splinting		
Back board, with straps	2	1
Backboard head immobilizer	1	1
Immobilizer board, pediatric capable	1	0
Extrication collars, rigid		
Adult (small, medium, large)	2ea	1ea
Pediatric (assorted)	1ea	1ea
Extrication device (immobilizer) adult	1	0
Splint, traction, adult w/straps	1	0
Splint, traction, pediatric, w/straps	1	0
Splint, adult (arm and leg)	2ea	1ea
Splint, pediatric (arm and leg)	1ea	1ea
General		
Litter, wheeled, collapsible	1	0
Pillows, plastic covered or disposable	2	0
Pillow case	4	0
Sheets	4	0
Blankets	4	2
Towels	4	0
Emesis collection device	1	1
Urinal	1	0
Bed pan	1	0
OB kit	1	1

Extrication		
Shovel	1	1
Hammer	1	1
Adjustable wrench, 10"	1	1
Hack saw, with blades	1	1
Crowbar, pinch point, 48" minimum	1	1
Screwdriver, straight tip, 10" minimum	1	1
Screwdriver, 3 Phillips, 10" minimum	1	1
Tin snips	1	1
Wrecking bar, 3' minimum	1	1
Pliers	1	1
Locking pliers	1	1
Bolt cutters, 1/2" min. jaw spread	1	1
Rope, utility, 50' x 3/8"	1	1

**NEW SECTION**

WAC 246-976-310 AMBULANCE AND AID VEHICLES—COMMUNICATIONS EQUIPMENT. (1) Ambulance and aid services shall provide each licensed vehicle with communication equipment which:

- (a) Is consistent with approved state and regional plans;
  - (b) Is in good working order;
  - (c) Allows direct two-way communication between the vehicle and its system control point; and
  - (d) Allows communication with the state-wide medical control system established in the state plan.
- (2) In addition to subsection (1) of this section, services shall provide each licensed ambulance with communication equipment which:
- (a) Allows direct two-way communication, from both the driver's and patient's compartments, with all hospitals in the service area of the vehicle;
  - (b) Incorporates appropriate encoding and selective signaling devices; and
  - (c) When transporting patients, allows communications with designated EMS/TC receiving facilities state-wide.

**NEW SECTION**

WAC 246-976-320 AIR AMBULANCE SERVICES. (1) The department shall:

- (a) Issue licenses to air ambulance services and aircraft which meet standards described in this section;
  - (b) Exclude from licensure requirements those services operating aircraft for primary purposes other than civilian air medical transport, but which may be called into service to initiate an emergency air medical transport of a patient to the nearest available treatment facility or rendezvous point with other means of transportation. Examples of services fitting this description include, but are not limited to: U.S. Army Military Assistance to Safety and Traffic, U.S. Navy, U.S. Coast Guard, Search and Rescue, and the U.S. Department of Transportation.
  - (c) Establish and publish minimum standards for air ambulance services, medical transport aircraft, and medical equipment required for licensure. Standards for aircraft shall be consistent with federal aviation administration regulations.
- (2) Air ambulance services shall:
- (a) Comply with all regulations in this chapter pertaining to ambulance services and vehicles, except as specifically modified in subsection (3)(b) and (c) of this section;
  - (b) Comply with the standards in this section for all types of transports, including inter-facility and prehospital transports;
  - (c) Be currently certified as an air taxi under federal aviation regulations Part 135, Air Taxi Operators and Commercial Operators of Small Aircraft. Air ambulance services shall comply with applicable federal aviation regulations contained in Parts 91 and 135, and conduct all maintenance activities in accordance with Part 43. Air ambulance services shall comply with any additional federal aviation administration regulations specifically dealing with air ambulance services.
- (3) Air ambulance services shall provide:
- (a) A physician director who is:
    - (i) Trained and experienced in emergency, trauma and critical care; and
    - (ii) Responsible for supervising and evaluating the quality of patient care provided by the air medical flight personnel;
  - (b) Sufficient air medical personnel on each response to provide adequate patient care, specific to the mission, including:

(i) One specially trained, experienced registered nurse or paramedic; and

(ii) One other person who may be a physician, nurse, physician's assistant, respiratory therapist, paramedic, EMT, or other appropriate specialist appointed by the physician director;

(iii) If an air ambulance responds directly to the scene of an incident, at least one of the air medical personnel shall be trained in pre-hospital emergency care;

(c) Aircraft that, when operated as air ambulances:

(i) Are configured in such a way that the medical attendants have access to the patient in order to begin and maintain advanced life support and other treatment modalities;

(ii) Allow loading and unloading the patient without excessive maneuvering or tilting of the stretcher;

(iii) Have appropriate communication equipment to insure internal crew and air-to-ground exchange of information between flight personnel and hospitals, medical control, the flight operations center and air traffic control facilities;

(iv) Are equipped with:

(A) Appropriate navigational aids;

(B) An electric inverter to convert direct current to alternating current, with a minimum power output of seven hundred fifty volt/amps, and two outlets;

(C) Airway management equipment, including:

(I) Oxygen;

(II) Suction;

(III) Ventilation and intubation equipment, adult and pediatric;

(D) Cardiac Monitor/Defibrillator;

(E) Supplies, equipment, and medication as required by the program physician director, for emergency, cardiac, trauma, pediatric care and other missions; and

(v) Have adequate interior lighting for patient care arranged so as not to interfere with the pilot's vision;

(d) If using fixed-wing aircraft, pressurized, multi-engine aircraft when appropriate to the mission;

(e) If using helicopter aircraft:

(i) A protective barrier sufficiently isolating the cockpit, in order to minimize in-flight distraction or interference;

(ii) Appropriate communication equipment to communicate with ground EMS/TC services and public safety vehicles, in addition to the communication equipment specified in (c)(iii) of this subsection.

(4) All air medical personnel shall:

(a) Be certified in ACLS;

(b) Be trained in:

(i) Emergency, trauma and critical care;

(ii) Altitude physiology;

(iii) EMS communications;

(iv) Aircraft and flight safety; and

(v) The use of all patient care equipment on board the aircraft;

(c) Be familiar with survival techniques appropriate to the terrain;

(d) Perform under protocols;

(e) Have their physical well being evaluated through periodic medical and hearing examinations. The results of these examinations shall be provided to the service physician director;

(5) In instances where aeromedical evacuation of a patient is necessary because of a life threatening condition and a licensed air ambulance is not available, patient transportation may be accomplished by the nearest available aircraft that can accommodate the patient. The physician ordering the transport shall justify the need for air transport of the patient in writing to the department within thirty days after the incident.

#### NEW SECTION

WAC 246-976-330 AMBULANCE AND AID SERVICES—RECORD REQUIREMENTS. (1) Each ambulance and aid vehicle service shall maintain a record of:

(a) Current certification levels of all personnel;

(b) Make, model, and license number of all vehicles; and

(c) Each patient contact with at least the following information:

(i) Names and certification levels of all personnel;

(ii) Date and time of medical emergency;

(iii) Age of patient;

(iv) Applicable components of system response time as defined in this chapter;

(v) Patient vital signs;

(vi) Procedures performed on the patient;

(vii) Mechanism of injury or type of illness;

(viii) Patient destination;

(ix) Other data points identified in this chapter for the trauma registry.

(2) Transporting agencies shall leave a copy of the patient care record at the receiving facility.

(3) Patient records are confidential. Disclosure of patient information shall be governed by applicable state and federal regulations on confidentiality.

(4) Licensed services shall make all records available for inspection and duplication upon request of the department.

#### NEW SECTION

WAC 246-976-340 AMBULANCE AND AID SERVICES—INSPECTIONS AND INVESTIGATIONS. (1) The department shall conduct periodic, unannounced inspections of licensed ambulances and aid vehicles services.

(2) If the service is also verified in accordance with WAC 246-976-390, the department shall include a review for compliance with verification standards as part of the inspections described in this section.

(3) Licensed services shall make available to the department copies of any printed or written materials relevant to the inspection, verification review, or investigative process.

#### NEW SECTION

WAC 246-976-350 AMBULANCE AND AID SERVICES—VARIANCES FROM REQUIREMENTS. (1) The department may grant a variance from ambulance and aid vehicle licensing requirements if:

(a) No detriment to health and safety would result from the variance; and

(b) Compliance is expected to cause reduction or loss of existing emergency medical services.

(2) Consistent with state and regional plans, the department may grant variances for a period of no more than one year. A variance may be renewed by the department upon approval of the L&C committee.

#### NEW SECTION

WAC 246-976-370 AMBULANCE AND AID SERVICES—PREHOSPITAL TRAUMA TRIAGE PROCEDURES. (1) Licensed ambulance and aid services shall comply with the state of Washington Prehospital Trauma Triage Procedures, March 11, 1992, or as subsequently revised by the department.

(2) The EMS provider shall make assessments to determine whether an injury is classified as a major trauma, including:

(a) Vital signs and level of consciousness;

(b) Anatomy of injury;

(c) Biomechanics of the injury; and

(d) Comorbid and associated risk factors.

(3) The prehospital provider shall activate the trauma system immediately for patients who meet the criteria for vital signs, level of consciousness, and anatomy of injury listed in the trauma triage procedures, steps one and two;

(4) The prehospital provider shall consult with medical control before activating the trauma system for patients who meet the criteria listed in the trauma triage procedures for biomechanics of injury and comorbid and associated risk factors, steps three and four, but not for vital signs, level of consciousness, or anatomy of injury.

#### VERIFICATION

#### NEW SECTION

WAC 246-976-390 VERIFICATION OF TRAUMA CARE SERVICES. (1) The department shall:

(a) Develop and provide procedures and application forms for verification;

(b) Establish and publish standards for verification of prehospital trauma care services in the following categories:

(i) Aid service, basic life support;

(ii) Ambulance, basic life support;

(iii) Aid service, intermediate life support;

(iv) Ambulance, intermediate life support;

(v) Aid service, paramedic;

(vi) Ambulance, paramedic;

(c) Review the minimum response times for verified prehospital trauma services at least biennially, considering data available from the trauma registry and with the advice of the steering committee;

(d) Approve an applicant to provide verified prehospital trauma care, based on satisfactory evaluations as described in this section;

(e) Notify the Regional Council and the MPD in writing of the name, location and level of verified services;

(f) Renew approval of a verified service upon reapplication, if the service continues to meet standards established in this chapter and the needs identified in the regional EMS/TC plan.

(2) For licensed aid services, the department shall:

(a) Establish and review biennially the minimum number of aid services needed to provide verified nontransport trauma care services based upon distribution and level of service identified for each response area in the approved regional plan;

(b) Evaluate applicants for aid service trauma verification based upon demonstrated ability of the provider to meet standards defined in this section;

(3) For licensed ambulance services, the department shall:

(a) Establish and review biennially the minimum and maximum number of verified ambulance services needed in the state and within each region to assure adequate availability and avoid inefficient duplication and lack of coordination of verified transport trauma care service based upon distribution and level of service identified for each response area identified in the approved regional plan;

(b) Evaluate applicants for ambulance trauma service verification based upon:

(i) Demonstrated ability of the provider to meet standards defined in this section;

(ii) The maximum number of ambulance services for each response area identified in the approved regional plans;

(iii) Preference for verification of existing licensed EMS/TC agencies, until January 1, 1995;

(iv) Recommendations from:

(A) EMS systems established by ordinance, resolution, interlocal agreement or contract;

(B) Local government; and

(C) Local and regional EMS/TC councils;

(v) Verification shall be renewed upon re-application, if the service continues to meet standards established in this chapter, and the needs identified in the regional plan.

(4) The Regional Councils shall:

(a) Identify the need for and distribution of verified aid services needed to assure adequate availability of prehospital aid service within the region for each response area, based upon agency response time standards, geography, topography, and population density for:

(i) Aid service, basic life support;

(ii) Aid service, intermediate basic life support;

(iii) Aid service, advanced life support;

(b) Identify the need for and distribution of verified ambulance services needed to assure adequate availability and avoid inefficient duplication and lack of coordination of prehospital ambulance service within the region for each response area based upon agency response time standards, geography, topography, and population density for:

(i) Ambulance, basic life support;

(ii) Ambulance, intermediate life support;

(iii) Ambulance, advanced life support.

(5) Licensed ambulance and aid services applying to become verified prehospital trauma care services shall submit application on forms provided by the department, including:

(a) Documentation required for licensure specified by WAC 246-976-260(2);

(b) By July 1, 1995, a policy that a trauma training program is required for all personnel responding to trauma incidents. The program shall meet learning objectives established by the department and be approved by the MPD;

(c) Documentation that the provider has the ability to deliver personnel and equipment required for verification to the scene of a trauma injury within the agency response times identified in this section; and

(d) By July 1, 1995, documentation that the provider is participating in an approved regional quality assurance program.

(6) Verified aid services shall provide personnel on each trauma response including:

(a) Aid service, basic life support: At least one individual, first responder or above;

(b) Aid service, intermediate life support: At least one IV/Airway technician; OR two individuals, one IV technician AND one airway technician;

(c) Aid service, advanced life support: At least one paramedic.

(7) Verified ambulance services shall provide personnel on each trauma response including:

(a) Ambulance, basic life support: At least two certified individuals — one EMT plus one first responder;

(b) Ambulance, intermediate life support:

(i) One IV/airway technician, plus one EMT; or

(ii) One IV technician and one airway technician, both of whom shall be in attendance in the patient compartment, plus a driver;

(c) Ambulance, paramedic: At least two certified individuals — one paramedic and one EMT.

(8) Verified aid and ambulance services shall provide equipment on each vehicle, including for intermediate life support (ILS) and paramedic (PAR) level of service:

	AMBULANCE		AID VEHICLE	
	PAR	ILS	PAR	ILS
<b>AIRWAY MANAGEMENT</b>				
Airway Adjuncts				
Oral airway (adult: sm, med, lg)	1ea	1ea	1ea	1ea
Oral airway (pediatric: 00,0,1,2,3,4)	0	1	0	1
Adjunctive airways, per protocol	1	1	1	1
Laryngoscope handle, spare batteries	1	1	1	1
Adult blades	1ea	1ea	1ea	1ea
Pediatric blades, straight (0,1,2)	1ea	1ea	1ea	1ea
Pediatric blades, curved (2,3,4)	1ea	1ea	1ea	1ea
McGill forceps, adult & pediatric	1	1	1	1
ET tubes, adult (5,6,7,8,9) w/stylet	1ea	1ea	1ea	1ea
ET tubes, pediatric, with stylet				
Uncuffed (2.5 - 6.0 mm)	1ea	1ea	1ea	1ea
Cuffed (6.0 - 7.0 mm)	1ea	1ea	1ea	1ea
Suction				
Portable, manual	1	1	1	1
Vehicle mounted	1	1	0	0
Tubing	1	1	1	1
Bulb syringe, pediatric	1	1	1	1
Catheters				
Adult (14 Fr x 22")	4	4	2	2
Pediatric (6,8,10 Fr)	1ea	1ea	1ea	1ea
Rigid suction tips				
Water, rinsing	2	2	1	1
Oxygen delivery				
Oxygen cylinder (3000L, 500PSI min)	1	1	0	0
Oxygen cylinder (300L, 500PSI min)	2	2	1	1
Regulator, oxygen (0-15+ Liter)	1	1	1	1
Cannula, nasal, adult	4	4	2	2
O <sub>2</sub> mask, adult	4	4	2	2
O <sub>2</sub> mask, pediatric	2	2	1	1
O <sub>2</sub> mask, nonrebreather, adult	4	4	2	2
O <sub>2</sub> mask, nonrebreather, pediatric	2	2	1	1
BVM, w/O <sub>2</sub> reservoir				
Adult	1	1	1	1
Peds, w/00, 1,2 masks	1	1	1	1
Pocket mask or equivalent	0	0	0	0
<b>PATIENT ASSESSMENT AND CARE</b>				
Assessment				
Sphygmomanometer				
Adult, large	1	1	1	1
Adult, regular	1	1	1	1
Pediatric	1	1	1	1
Infant	1	1	1	1
Stethoscope				
Adult	1	1	1	1
Pediatric	1	1	1	1
Thermometer, oral, hypothermia	1ea	1ea	0	0
Flashlight, w/spare batteries & bulb	1	1	1	1
Personal infection control				
Gloves, exam, nonsterile (box)	1	1	1	1
Other equipment per WISHA requirements	Yes	Yes	Yes	Yes
<b>MEDICAL EMERGENCIES</b>				
Wound care				
Dressing, sterile	asst	asst	asst	asst
Dressing, sterile, trauma	6	6	4	4
Roller gauze bandage	asst	asst	asst	asst
Triangular bandage	4	4	4	4
Medical tape				
Self adhesive bandage strips	asst	asst	asst	asst
Cold packs	4	4	2	2
Occlusive dressings	2	2	2	2
Burn sheets	2	2	2	2
Scissors, bandage	1	1	1	1
Irrigation solution	2	2	1	1

AMBULANCE AID VEHICLE  
PAR ILS PAR ILS

Splinting				
Back board, with straps	2	2	1	1
Backboard head immobilizer	1	1	1	1
Immobilizer board, pediatric capable	1	1	1	1
Extrication collars, rigid				
Adult (small, medium, large)	2ea	2ea	1ea	1ea
Pediatric (assorted)	1ea	1ea	1ea	1ea
Extrication device (immobilizer) adult	1	1	1	1
Splint, traction, adult with straps	1	1	1	1
Splint, traction, pediatric, w/straps	1	1	1	1
Splint, adult (arm and leg)	2ea	2ea	1ea	1ea
Splint, pediatric (arm and leg)	1ea	1ea	1ea	1ea
IV access				
Isotonic solution	4L	4L	2L	2L
D5W	4L	4L	2L	2L
Administration sets				
Adult	4	4	2	2
Pediatric, w/volume control	4	4	2	2
Catheters, intravenous (14-24 ga)	asst	asst	asst	asst
Needles				
Hypodermic	asst	0	asst	0
Pediatric,	asst	asst	asst	asst
Intraosseous, per protocol	2	0	1	0
Sharps container	1	1	1	1
Syringes	asst	0	asst	0
Glucose measuring supplies	Yes	0	Yes	0
Pressure infusion device	1	1	1	1
Cardiac care				
Monitor/defibrillator (manual capable)	1	0	1	0
Pediatric paddles (pair)	1	0	1	0
Adult medications per protocol	Yes	0	Yes	0
Pediatric medications per protocol	Yes	0	Yes	0
Pediatric reference material	Yes	Yes	Yes	Yes
General				
Litter, wheeled, collapsible, w/straps	1	1	0	0
Pillows (plastic cover or disposable)	2	2	0	0
Pillow case	4	4	0	0
Sheets	4	4	0	0
Blankets	4	4	2	2
Towels	4	4	0	0
Emesis collection device	1	1	1	1
Urinal	1	1	0	0
Bed pan	1	1	0	0
OB kit	1	1	1	1
Extrication				
Shovel	1	1	1	1
Hammer	1	1	1	1
Adjustable wrench, 10"	1	1	1	1
Hack saw, with blades	1	1	1	1
Crowbar, pinch point, 48" minimum	1	1	1	1
Screwdriver, straight tip, 10" minimum	1	1	1	1
Screwdriver, 3 Phillips, 10" minimum	1	1	1	1
Tin snips	1	1	1	1
Wrecking bar, 3' minimum	1	1	1	1
Pliers	1	1	1	1
Locking pliers	1	1	1	1
Bolt cutters, 1/2" min. jaw spread	1	1	1	1
Rope, utility, 50' x 3/8"	1	1	1	1

(2) By January 1994, all verified trauma services shall participate in the regional quality assurance program established by RCW 70.168.090(2).

(3) Verified aid services shall meet the following minimum agency response times for response areas as defined by the department and identified in the approved regional plan:

- (a) To urban response areas: Eight minutes or less, eighty percent of the time;
- (b) To suburban response areas: Fifteen minutes or less, eighty percent of the time;
- (c) To rural response areas: Forty-five minutes or less, eighty percent of the time;
- (d) To wilderness response areas: As soon as possible.

(4) Verified ambulance services shall meet the following minimum agency response times for response areas as defined by the department and identified in the approved regional plan:

- (a) To urban response areas: Ten minutes or less, eighty percent of the time;
- (b) To suburban response areas: Twenty minutes or less, eighty percent of the time;
- (c) To rural response areas: Forty-five minutes or less, eighty percent of the time;
- (d) To wilderness response areas: As soon as possible.

(5) A verified prehospital trauma care service, or an applicant for verification, may request a variance from the requirements of this section.

(6) The department may:

(a) Grant a variance from ambulance and aid service verification requirements for a period not to exceed one year if the department determines:

(i) No detriment to public health and safety will result from the variance; and

(ii) Compliance with the provisions of this section will cause a reduction or loss of existing prehospital services;

(b) Renew a variance. If a renewal is granted, the verified service shall prepare a plan to bring the provider or region into compliance and the expected date of compliance, consistent with the regional EMS/TC plan.

NEW SECTION

WAC 246-976-400 VERIFICATION—NONCOMPLIANCE WITH STANDARDS. If the department finds that a verified prehospital trauma care service is out of compliance with verification standards:

(1) The department shall promptly notify in writing: the service, the MPD, the local and regional EMS/TC councils;

(2) The service shall, within thirty days of notification by the department, submit a corrective plan to the MPD and the regional council outlining proposed action to bring the service into compliance.

(3) The MPD and the regional council shall, within thirty days of receipt of the service's corrective plan, forward their recommendations on the plan to the department.

(4) The department shall, within thirty days, review the plan and recommendations of the Regional Council and MPD, and notify the service of acceptance or rejection.

(5) The regional council may:

(a) Seek assistance and funding from the department and others to provide training or grants necessary to bring the verified prehospital trauma service into compliance; and/or

(b) Appeal to the department for modification of the regional plan if it is unable to assure continued compliance with the regional plan.

(6) The department shall monitor the service's progress in fulfilling the terms of the approved plan.

(7) If the service is either unable or unwilling to comply with the verification standards, under the provisions of chapter 34.05 RCW, the department may suspend or revoke the verification. The department shall promptly notify the regional council and the MPD of any revocation or suspension of verification.

TRAUMA REGISTRY

NEW SECTION

WAC 246-976-420 TRAUMA REGISTRY—DEPARTMENT RESPONSIBILITIES. (1) The department shall:

(a) Establish a state-wide data registry to collect and analyze data on the incidence, severity, and causes of trauma, including traumatic brain injury for the purposes of:

- (i) Monitoring and providing information necessary to evaluate major trauma patient care and outcome;
- (ii) Assessing compliance of prehospital providers, health care facilities, hospitals and rehabilitation services with the standards of state trauma system operation and designation;
- (iii) Providing information necessary for resource planning and management;
- (iv) Providing data for injury surveillance, analysis and prevention programs; and
- (v) Providing a resource for research and education;

(b) Establish criteria to identify patients to be included in the state trauma registry by:

- (i) All licensed prehospital providers;
- (ii) Health care facilities, both designated (all levels) and nondesignated;
- (iii) Designated trauma rehabilitation services;
- (iv) Medical examiner reports;
- (v) Other sources outside of the EMS/TC System which may include but not be limited to:



- (A) Death certificates;
  - (B) Washington Fire Incident Report System;
  - (C) Commission's Hospital Abstract Reporting System (CHARS);
- and
- (D) Law enforcement agency records;
  - (c) Establish, publish and periodically review the required data elements to be submitted to provide information regarding injury, trauma care, and system operation, in the following categories:
    - (i) Demographic;
    - (ii) Anatomic;
    - (iii) Physiologic;
    - (iv) Severity;
    - (v) Epidemiologic;
    - (vi) Resource utilization;
    - (vii) Quality assurance;
    - (viii) Outcome; and
    - (ix) Financial;
  - (d) Require a case specific patient identifier common to all data sources used in the registry;
  - (e) Provide procedures for electronic submission of data, including specifications for necessary software; or provide paper forms for manual submission of data;
    - (f) For data quality assurance:
      - (i) Develop detailed protocols for quality control, consistent with the department's most current data quality guidelines;
      - (ii) Perform validity studies to assess the completeness and accuracy of case identification and data collection;
      - (iii) Provide a report on completeness and accuracy of data submitted for each provider submitting data to the registry;
    - (g) Conclude a pilot of the trauma registry by July 1993, which assesses the impact of data reporting on hospital and prehospital participants, and evaluates the appropriateness of the inclusion criteria and required data elements; and
    - (h) Evaluate requests from regional EMS/TC councils for collection of voluntarily submitted additional data elements from agencies and facilities in that region.

**NEW SECTION**

**WAC 246-976-430 TRAUMA REGISTRY—PROVIDER RESPONSIBILITIES.** (1) All licensed prehospital services shall:

- (a) Use the following criteria for inclusion of patient data in the trauma registry:
  - (i) Trauma victims dead at scene; and
  - (ii) All patients meeting trauma triage criteria who are transported to a health care facility;
- (b) Submit required registry data via electronic transfer; or, if authorized in writing by the department, on approved paper forms.
- (2) The first licensed service on the scene shall be responsible for submitting the following data on all patients identified in subsection (1) of this section, treated during each calendar quarter. Data shall arrive at the registry in an approved format no later than ninety days after the end of the quarter:
  - (a) Run sheet number;
  - (b) Name or name code, when available;
  - (c) Date of birth when available;
  - (d) Age;
  - (e) Sex;
  - (f) Agency incident number;
  - (g) Patient's trauma identification number;
  - (h) Agency identification number;
  - (i) First agency on scene (yes/no);
  - (j) Transporting agency identification;
  - (k) Level of transporting agency (BLS/ALS);
  - (l) Incident county code;
  - (m) Response area code of incident (urban, suburban, rural, wilderness);
  - (n) Date of incident;
  - (o) Time:
    - (i) Call received;
    - (ii) Dispatched;
    - (iii) Arrived at scene;
  - (p) First scene:
    - (i) Systolic blood pressure;
    - (ii) Respiratory rate;
    - (iii) Pulse;
    - (q) Glasgow coma score – eye, verbal and motor;
    - (r) Systolic blood pressure less than 90 mm Hg in field (yes/no);

- (s) Mechanism of injury;
- (t) Prehospital trauma system activation (yes/no);
- (u) Extrication required;
- (v) Patient entrapped (yes/no);
- (w) Safety restraint or device used;
- (x) Field interventions done; and
- (y) Additional information if patient died at scene:
  - (i) Patient home zip code;
  - (ii) Patient race and ethnicity when available.
- (3) The transporting service shall be responsible for submitting the following data on all patients identified in subsection (1) of this section, treated during each calendar quarter. Data shall arrive at the registry in an approved format no later than ninety days after the end of the quarter:
  - (a) Run sheet number or file number;
  - (b) Name or name code;
  - (c) Date of birth, when available;
  - (d) Age;
  - (e) Sex;
  - (f) Agency incident number;
  - (g) Patient's trauma identification number;
  - (h) Agency identification number;
  - (i) First agency on scene identification number;
  - (j) Transporting agency identification;
  - (k) Level of transporting agency (BLS/ALS);
  - (l) Intra-facility transport;
  - (m) Incident county code;
  - (n) Response area code of incident (urban, suburban, rural, wilderness);
  - (o) Date of incident;
  - (p) First hospital transported to (code);
  - (q) Second hospital transported to (code);
  - (r) Intra-field rendezvous transport agency identification number;
  - (s) Time of:
    - (i) Call received;
    - (ii) Dispatch;
    - (iii) Arrival at scene;
    - (iv) Departure from scene;
    - (v) Arrival at intra-field destination or rendezvous;
    - (vi) Arrival at first hospital;
    - (vii) Departure from first hospital;
    - (viii) Arrival at second hospital;
  - (t) First:
    - (i) Systolic blood pressure;
    - (ii) Respiratory rate;
    - (iii) Pulse;
    - (iv) Glasgow coma score – eye, verbal and motor;
    - (u) Systolic blood pressure less than ninety mm Hg in field;
    - (v) Mechanism of injury;
    - (w) Trauma triage criteria met;
    - (x) Prehospital trauma system activation (yes/no);
    - (y) Extrication required;
    - (z) Patient entrapped (yes/no);
    - (aa) Safety restraint/device used;
    - (bb) Field interventions done;
    - (cc) Receiving hospital contacted (code);
    - (dd) Diverted;
    - (ee) Mode of transport; and
    - (ff) Additional information if patient dies in route:
      - (i) Patient home zip code;
      - (ii) Patient race and/or ethnicity, when available;
  - (4) Licensed ambulance services transporting patients between facilities shall be responsible for submitting the following data on all patients identified in subsection (1) of this section, treated during each calendar quarter. Data shall arrive at the registry in an approved format no later than ninety days after the end of the quarter:
    - (a) Run sheet number;
    - (b) Patient's trauma identification number;
    - (c) Agency identification number;
    - (d) Inter-facility transfer (yes/no);
    - (e) Mode of transport;
    - (f) Level of transport (BLS/ALS);
    - (g) Time:
      - (i) Call received;
      - (ii) Arrived at hospital;
      - (h) Originating facility (code);
      - (i) Destination facility (code);

- (5) Designated trauma care facilities at all levels shall:
- (a) Use the following criteria for inclusion of patient data in the trauma registry:
- (i) All trauma patients dead on arrival at health care facility;
  - (ii) All trauma patients discharged deceased from health care facility;
  - (iii) All trauma patients transferred to another facility;
  - (iv) Other patients with all three of the following:
    - (A) Emergency admit, UB-82; and
    - (B) Length of stay greater than two days or forty-eight hours; and
    - (C) Discharge diagnosis ICD-9-CM codes of 800 - 904.99 or 910 - 959.9;
  - (b) Submit required registry data via electronic transfer; or, if authorized in writing by the department, on approved paper forms;
  - (c) Submit the following data for patients identified in subsection (5)(a) of this section, who were discharged during each calendar quarter. Data shall arrive at the registry in an approved format no later than ninety days after the end of the quarter:
    - (i) Identification of facility;
    - (ii) Unique patient identification number assigned to the patient by the facility;
    - (iii) Arrival via EMS system;
    - (iv) Prehospital run sheet number, when available;
    - (v) Date of ED arrival;
    - (vi) Time of ED arrival;
    - (vii) Date of incident;
    - (viii) Initial hospital;
    - (ix) Facility patient was transferred from;
    - (x) Patient information:
      - (A) Name or name code;
      - (B) Date of birth;
      - (C) Sex;
      - (D) Race and ethnicity;
      - (E) Patient's trauma identification number;
      - (F) Social Security number;
      - (G) Home zip code number;
      - (H) Organ donor;
      - (xi) Mechanism of injury;
      - (xii) Safety restraint/device used;
      - (xiii) Prehospital Index score on admission;
      - (xiv) Time of first contact with ED physician;
      - (xv) Trauma team activated (yes/no);
      - (xvi) Time of arrival of surgeon in ED;
      - (xvii) First systolic blood pressure in ED;
      - (xviii) First temperature in ED;
      - (xix) First pulse rate in ED;
      - (xx) First spontaneous respiration rate in ED;
      - (xxi) Lowest systolic blood pressure in ED;
      - (xxii) Glasgow coma score in ED - eye, verbal and motor;
      - (xxiii) Patient intubated at first GCS;
      - (xxiv) Patient pharmacologically paralyzed at first GCS;
      - (xxv) ED procedures performed;
      - (xxvi) Time of ED discharge;
      - (xxvii) ED discharge disposition;
      - (xxviii) Admitting Service;
      - (xxix) CT scan of head done (yes/no);
      - (xxx) Date of head CT scan;
      - (xxxii) For each operation:
        - (A) Date and time patient arrived in operating room;
        - (B) Date and time operation started;
        - (C) Most recent ICD codes;
        - (xxxiii) Length of primary stay in intensive care unit;
        - (xxxiv) Length of readmission stay in intensive care unit;
        - (xxxv) Co-morbidity complications;
        - (xxxvi) Physical therapy consult;
        - (xxxvii) Date of physical therapy consult;
        - (xxxviii) Rehabilitation consult;
        - (xxxix) Date of rehabilitation consult;
      - (xl) Disability at acute care discharge:
        - (A) Feeding;
        - (B) Locomotion;
        - (C) Expression;
        - (xli) Glasgow outcome score at discharge;
        - (xlii) Date of facility discharge;
        - (xliii) Time of facility discharge;
        - (xliv) Discharge disposition;
        - (xlv) Rehabilitation facility identification number;
        - (xlvi) Autopsy done (yes/no);
        - (xlvii) Date of death;
        - (xlviii) Time of death;
        - (lix) Most recent ICD diagnosis codes/discharge codes;
          - (i) E-code;
          - (ii) Occupational injury;
          - (lii) Safety restraint/device used; and
          - (liii) Payer source;
        - (l) Submit reimbursement information on trauma registry patients annually, including:
          - (i) Total billed charges;
          - (ii) Remitted reimbursement by each payer category; and
          - (iii) Ratio of cost to charges, by department.
      - (6) Designated rehabilitation facilities shall:
        - (a) Inclusion patient data for the trauma registry on all patients whose primary admission diagnosis is trauma, including ICD diagnosis codes of 800 - 904.99 or 910 - 959.9;
        - (b) Submit the following data for patients identified in subsection (6)(a) of this section, who were discharged during each calendar quarter. Data shall arrive at the registry in an approved format no later than ninety days after the end of the quarter:
          - (i) Rehabilitation facility identification number;
          - (ii) Trauma tag/identification number;
          - (iii) Name or name code;
          - (iv) Social security number;
          - (v) Sex;
          - (vi) Date of birth;
          - (vii) Date of admission to rehabilitation;
          - (viii) First admit (yes/no);
          - (ix) Continuing admit (yes/no);
          - (x) Impairment code, from the national uniform data set;
          - (xi) Source of admission;
          - (xii) Level of cognitive function on admission (Rancho scale);
          - (xiii) Tracheostomy;
          - (xiv) Ventilator dependent;
          - (xv) Feeding tube;
          - (xvi) Admission functional independence measure, from the national uniform data set (FIM or WEE FIM);
          - (xvii) Complications;
          - (xviii) Premorbid physiological, cognitive and mental conditions;
          - (xix) Highest grade completed;
          - (xx) Level of cognitive function on discharge (Rancho scale);
          - (xxi) Functional independence measure on discharge, from the national uniform data set (FIM or WEE FIM score);
          - (xxii) Discharged with tracheostomy;
          - (xxiii) Discharged ventilator dependent;
          - (xxiv) Discharged with feeding tube;
          - (xxv) Discharge due to medical problem (yes/no);
          - (xxvi) Date of discharge due to medical problem;
          - (xxvii) Readmitted after medically required interruption;
          - (xxviii) Date of readmission after interruption;
          - (xxix) Patient did not return after interruption;
          - (xxx) Discharged to;
          - (xxxii) Discharge date from rehabilitation;
          - (xxxiii) Rehabilitation services ordered at discharge;
          - (xxxiv) Community support system; and
          - (xxxv) Payer source - primary and secondary;
      - (c) Submit reimbursement information on trauma registry patients annually, including:
        - (i) Total billed charges;
        - (ii) Remitted reimbursement by each payer category; and
        - (iii) Ratio of cost to charges, by department.
    - (7) Medical examiners and coroners may:
      - (a) Submit data to the registry on all patients with injury listed as an underlying cause or contributing factor to death on the death certificate;
      - (b) Submit the following data for all patients meeting the inclusion criteria identified in (7)(a) above:
        - (i) Patient:
          - (A) Name or name code;
          - (B) Date of birth;
          - (C) Social Security number;
          - (D) Patient's trauma identification number;
          - (E) Gender;
          - (F) Race and/or ethnicity;

- (G) Date of incident;
- (H) Date of death; and
- (I) Home zip code;
- (ii) Medical examiner number/coroner identification number;
- (iii) Medical examiner/coroner facility identification number;
- (iv) Autopsy done;
- (v) Mechanism of injury;
- (vi) Organ donor;
- (vii) Cause of death; and
- (viii) Most recent ICD diagnosis code or equivalent description.

#### NEW SECTION

WAC 246-976-440 TRAUMA REGISTRY—REPORTS. (1) Within three months after the reporting period, the department shall report:

- (a) Semi-annually and annually on all patient data entered into the trauma registry during the reporting period;
  - (d) Semi-annually on trends, patient care outcomes, and other data, for each EMS/TC region and for the state, for the purpose of regional evaluation;
  - (h) Periodically on report financial data.
- (2) The department shall provide:
- (b) Registry reports to all providers that have submitted data;
  - (f) For the generation of quarterly reports to all providers submitting data to the registry, for the purpose of planning, management and quality assurance;
  - (e) Provider-specific raw data to the provider that originally submitted it;
  - (c) Aggregate regional data semi-annually to the regional EMS/TC council, excluding any confidential or identifying data.

**Reviser's note:** The typographical errors in the above section occurred in the copy filed by the agency and appear in the Register pursuant to the requirements of RCW 34.08.040.

#### NEW SECTION

WAC 246-976-450 ACCESS AND RELEASE OF TRAUMA REGISTRY INFORMATION. (1) Data elements related to the identification of individual patient's, provider's and facility's care outcomes shall be confidential, shall be exempt from RCW 42.17.250 through 42.17.450, and shall not be subject to discovery by subpoena or admissible as evidence.

(2) Persons with access to information collected under this chapter shall use the information for only those purposes stipulated in the chapter.

(3) The department may approve requests for data and other information from the registry for special studies and analyses, consistent with requirements for confidentiality of patient and quality assurance records. The release of confidential information shall be governed by the provisions of current laws regarding disclosure of personal records. In accordance with those provisions, confidential information shall not be disclosed, except:

- (a) On request, to an approved regional quality assurance program which is bound by the same confidentiality guidelines as the department;
- (b) On request, to a scientific research professional associated with a bona fide scientific research organization, providing:
  - (i) The research professional's written research proposal has been reviewed and approved by the DSHS/DOH Human Research Review Board with respect to the scientific merit and confidentiality safeguards; and
  - (ii) The department has given administrative approval for the proposal.
- (c) The department may require requestors to pay any or all of the reasonable costs associated with such requests that might be approved.

### DESIGNATION OF TRAUMA CARE FACILITIES

#### NEW SECTION

WAC 246-976-470 TRAUMA CARE FACILITIES—DESIGNATION PROCESS. (1) The department shall develop a request for proposal (RFP) for facilities seeking designation or renewal of designation as trauma care services. The RFP shall include:

- (a) System standards for facility level and category of designation sought;

- (b) Application requirements;
- (c) Evaluation criteria;
- (d) Goals and objectives of the facility;
- (e) Capability to provide trauma care;
- (f) Commitment to serve the trauma care needs of the state-wide system;

(g) Compliance with goals of the regional EMS/TC plan; and  
(h) Geographic coverage.

(2) The applicant for designation as a trauma care service shall submit to the department within ninety days of receipt of the RFP:

- (a) A completed proposal packet; and
  - (b) Fees as required by WAC 246-976-990.
- (3) The department may:
- (a) Consider and approve requests for designation for more than one level or category of trauma service from a single facility at one time;
  - (b) Consider and approve single proposals from two or more facilities for joint provision of a single level or category of trauma service. If the department grants joint designation, it shall resurvey the facilities at the end of twelve months of operation, to confirm compliance with the provisions of this chapter; and/or
  - (c) In order to ensure adequate trauma care, grant provisional designation, for a period not exceeding one year, to facilities that are currently unable to fully meet the standards of this chapter.
- (4) The department shall:
- (a) Conduct on-site review of applicant's facilities in accordance with WAC 246-976-475;
  - (b) Consider proposals from facilities located and licensed in adjacent states in the same manner as proposals received from facilities located and licensed in Washington; and
  - (c) Evaluate applications for joint designation following the same criteria as for a single-facility application.
- (5) After an evaluation to determine the current capability of each applicant to meet or exceed the requirements of this chapter, the department shall designate the health care facilities it deems most qualified to provide trauma care services, based on:

- (a) Evaluation of the proposals submitted;
  - (b) Recommendations from the on-site review team;
  - (c) Trauma patient outcomes during the previous designation period;
  - (d) The best interests of the patients of the area;
  - (e) Expected patient volume of the area;
  - (f) The number and levels of designated health care facilities established by the state and regional EMS/TC plans;
  - (g) Ability of each applicant to comply with goals of the state and regional EMS/TC plans; and
  - (h) Compliance with contractual obligations to the department during the previous designation period;
- (6) The department shall:
- (a) Notify the applicant in writing of designation or denial of designation. Notification shall include a written report of the on-site review; and

(b) Notify regional EMS/TC councils of the name, location, level and category of service of facilities that have been designated in their regions.

(7) The department and the designated facility shall enter into a contractual agreement. The contract shall:

- (a) Authorize the facility to provide trauma care service for a three year period;
  - (b) Identify the contractual and financial requirements and responsibilities of both the facility and the department;
  - (c) Allow the department to monitor compliance with regulations and standards during the contract period, including access to:
    - (i) Patient discharge summaries;
    - (ii) Patient care logs;
    - (iii) Patient care records;
    - (iv) Hospital trauma care quality assurance program records, including minutes; and
    - (v) Other relevant documents; and
  - (d) Require confidentiality of information relating to individual patient's, provider's, and facility's care outcomes.
- (8) The department shall issue a new RFP as described in this section, for all interested health care facilities, including those currently designated, no later than one hundred fifty days prior to the expiration of each service's current designation.

#### NEW SECTION

WAC 246-976-475 ON-SITE REVIEW FOR DESIGNATION. The department shall require an on-site review of an applicant facility

for levels I, II, and III trauma care services, and for levels I, II, and III pediatric trauma care services, prior to designation.

(1) The department shall establish multidisciplinary review teams composed of individuals knowledgeable in EMS/TC, appropriate to the level of designation requested, which may include:

- (a) Surgeons;
- (b) Emergency physicians;
- (c) Trauma nurse coordinators;
- (d) Physicians knowledgeable in pediatric trauma care;
- (e) Hospital or other medical administrators;
- (f) EMS personnel;
- (g) Department personnel; and/or
- (h) Other specialists as needed for the level and category applied for.

(2) The department shall conduct on-site review using teams whose members do not live or work:

- (a) In the same state as the applicant, for designation of levels I and II trauma services, and for levels I and II pediatric trauma services; or
- (b) In the same county as the applicant, for designation of levels III trauma care services, and for level III pediatric trauma services;

(3) The department may conduct on-site review of applicants for levels IV or V trauma care services.

(4) The on-site review team shall evaluate the appropriateness and capabilities of the applicant to provide high-quality trauma care services, and validate its ability to meet the responsibilities, equipment and performance standards for the level of designation sought, by:

- (a) Inspecting the facility;
- (b) Examining hospital records, including patient care records;
- (c) Interviewing appropriate individuals;
- (5) The on-site review team shall:

(a) Make a verbal report of findings to the applicant prior to leaving the facility; and

- (b) Make written recommendations to the department.

(6) The department shall require and maintain confidentiality of information, records and reports developed pursuant to on-site reviews. Such reports shall be exempt from public disclosure under the provisions of RCW 70.168.070, and not subject to discovery by subpoena or admissible as evidence. Members of the on-site review team shall not divulge, and cannot be subpoenaed to divulge, any information obtained or included in reports submitted to the department relating to the on-site review, including in any civil action resulting from the department's designation process.

(7) The applicant may submit to the department written objections or concerns of conflict of interest regarding any member of the on-site review team.

#### NEW SECTION

WAC 246-976-480 DENIAL, REVOCATION OR SUSPENSION OF DESIGNATION. (1) The department shall deny the application for designation if it finds, in the course of the designation process, that the facility:

- (a) Is not the most qualified applicant, when the number of applicants exceeds the number of facilities identified in the state plan;
- (b) Is unable to meet the requirements of this chapter for the level of designation sought;
- (c) Makes a false statement of a material fact in its application for designation;
- (d) Refuses to allow representatives of the department to inspect any part of the facility, records, documentation, or files; or
- (e) Is unable to meet or comply with the requirements of the approved regional plan.

(2) The department shall revoke or suspend designation of a health care facility if any owner, officer, director, or managing employee:

- (a) Fails or refuses to comply with the provisions of this chapter or chapter 70.168 RCW;
- (b) Fails to provide data to the registry;
- (c) Makes a false statement of a material fact in the application for designation, or in any record required by this chapter, or in a matter under investigation;
- (d) Prevents, interferes with, or attempts to impede in any way, the work of a representative of the department in the lawful enforcement of this chapter or chapter 70.168 RCW;
- (e) Uses false, fraudulent, or misleading advertising, or makes any public claims regarding the facility's ability to care for nontrauma patients based on its trauma care designation status;
- (f) Misrepresents or is fraudulent in any aspect of conducting business;

(g) Is substantially out of compliance with the requirements of this chapter and RCW 70.168, and has been unable or refused to comply as required by the department; or

(h) Fails to comply with the terms of its contract, as documented, reviewed, and confirmed by the department.

(3) The following process shall be used when designation is denied, revoked or suspended:

(a) The department shall notify a facility in writing of denial, revocation or suspension of designation. Such notice shall include:

- (i) The reasons for the action; and
- (ii) Rights of the facility, which include a right to hearing, and may also include the opportunity to submit a plan of correction according to (c) - (e) of this subsection.

(b) The department shall notify the regional EMS/TC council of the action taken.

(c) A designated facility found to be out of compliance with chapter 70.168 RCW and this chapter may, within thirty working days, submit a plan of correction to the department. The plan shall include steps the facility is to take to correct deficiencies.

(d) The department shall approve or disapprove the plan within thirty working days.

(e) Upon notification that the plan of correction is approved by the department, the facility shall implement that plan within thirty working days, and notify the department upon completion.

(f) Upon satisfactory evidence of compliance with chapter 70.168 RCW and this chapter, which may include an on-site review, the department shall reinstate designation status.

(g) The facility may appeal decisions of denial, suspension, or revocation of designation in accordance with the provisions of chapter 34-.05 RCW and chapter 246-08 WAC. Appeals should be addressed to the office of EMS and trauma systems, Department of Health, Olympia, WA 98504.

#### NEW SECTION

WAC 246-976-500 DESIGNATION STANDARDS FOR LEVEL I TRAUMA CARE HOSPITAL—ADMINISTRATION AND ORGANIZATION. (1) For the purpose of administering trauma care, a designated level I hospital shall have a trauma service, including:

(a) Organization and direction by a general surgeon who is expert in, and committed to, care of the injured;

(b) A multidisciplinary trauma committee with input to hospital management, including:

- (i) An emergency physician;
- (ii) An ED registered nurse;
- (iii) A trauma surgeon;
- (iv) A neurosurgeon;
- (v) An orthopaedic surgeon;
- (vi) A pediatric physician;
- (vii) An anesthesiologist;
- (viii) Director of intensive care unit; and
- (ix) An intensive care registered nurse;

(c) A trauma resuscitation team to provide initial evaluation and treatment.

(i) The team shall be organized and directed by a general surgeon who is expert in and committed to care of the injured, and who assumes responsibility for coordination of overall care of the trauma patient. The surgeon shall be at least a post-graduate year four resident;

(ii) All members of the team, including the surgeon, shall be in-house and available within five minutes;

(iii) The team shall include an emergency physician:

(A) Responsible for activating the trauma resuscitation team, using an approved scoring system; and

(B) Responsible for providing team leadership and care for the trauma patient until the arrival of the surgeon in the resuscitation area;

(iv) Other members of the team shall be as specified in the hospital's application for designation;

(d) Specific delineation of trauma surgery privileges by the medical staff.

(2) A level I trauma care hospital shall have an ED with established standards and procedures to ensure immediate and appropriate care for adult and pediatric trauma patients.

(3) A level I trauma care hospital shall have a surgery department, including:

(a) General surgery, including a trauma surgeon, in-house and available on patient's arrival in the ED, assuming five minute prehospital notification;

(b) Neurosurgery:

(i) In-house and available within five minutes, by a board certified neurosurgeon, or by a surgeon who has been judged competent by the neurologic consultants on staff to initiate measures to stabilize the patient, and to initiate diagnostic procedures; and

(ii) With a board-certified neurosurgeon on-call and available within thirty minutes;

(c) The following services on-call and available within thirty minutes:

(i) Gynecologic surgery;

(ii) Hand surgery;

(iii) Microsurgery;

(iv) Obstetric surgery;

(v) Orthopaedic surgery;

(vi) Otorhinolaryngologic/maxillofacial surgery capable of managing upper airway trauma;

(vii) Plastic surgery;

(viii) Thoracic surgery; and

(ix) Urologic surgery.

(4) A level I trauma care hospital shall have nonsurgical specialties including:

(a) Anesthesiology, with an anesthesiologist who:

(i) Is ACLS certified;

(ii) Is in-house and available within five minutes;

(b) A radiologist on-call and available within twenty minutes;

(c) The following services on-call and available within thirty minutes:

(i) Cardiology;

(ii) Gastroenterology;

(iii) Hematology;

(iv) Infectious disease specialists;

(v) Internal medicine;

(vi) Nephrology;

(vii) Pathology;

(viii) Pediatrics;

(ix) Pulmonology; and

(k) Psychiatry;

(5) A level I trauma care hospital shall have a pediatric trauma policy that:

(a) Provides for initial stabilization and resuscitation of pediatric trauma patients, including ED and operating room interventions; and

(b) If it is not a level I pediatric hospital, includes written provision to transfer the patient to a designated level I pediatric trauma facility.

(6) A level I trauma care hospital shall have an approved policy to divert patients to other designated facilities, based on its ability to manage each patient at a particular time.

(7) A level I trauma care hospital shall:

(a) Have a quality assurance program in accordance with WAC 246-976-880; and

(b) Cooperate with regional trauma care quality assurance programs throughout the state established pursuant to WAC 246-976-910.

## NEW SECTION

WAC 246-976-510 DESIGNATION STANDARDS FOR LEVEL I TRAUMA CARE HOSPITALS—BASIC RESOURCES AND CAPABILITIES. (1) A level I trauma care hospital shall have an ED with:

(a) A physician director who is:

(i) Board certified or eligible in emergency medicine;

(ii) ATLS trained; and

(iii) ACLS certified;

(b) Emergency physicians who are:

(i) Board certified or eligible in emergency medicine, or who are practicing emergency medicine as their primary practice with special competency in care of trauma patients;

(ii) In-house and available within five minutes to patient on arrival to ED;

(iii) ATLS trained;

(iv) ACLS certified;

(v) PALS or approved equivalent trained; and

(vi) Designated members of the trauma team;

(c) ED registered nurses who:

(i) Are ACLS certified;

(ii) Are PALS or approved equivalent trained;

(iii) Have taken a trauma life support course; and

(iv) Are in the ED and available to the patient within five minutes; with at least two Rns on duty per shift;

(d) Equipment for resuscitation and life support of pediatric and adult trauma patients, including:

(i) Airway control and ventilation equipment including:

(A) Airways;

(B) Laryngoscopes, including curved and straight;

(C) Endotracheal tubes of all sizes;

(D) Bag-mask resuscitator, all sizes;

(E) Sources of oxygen; and

(F) Mechanical ventilation;

(ii) Suction devices, including:

(A) Back up suction source;

(B) Pediatric and adult suction catheters; and

(C) Tonsil suction tip;

(iii) Electrocardiograph;

(iv) Cardiac monitor;

(v) Defibrillator, including pediatric paddles;

(vi) All standard apparatus to establish central venous pressure monitoring;

(vii) All standard intravenous fluids and administering devices for adult and pediatric patients, including intravenous and intraosseous needles;

(viii) Sterile surgical sets for procedures standard for ED such as thoracostomy and cut down, including adult and pediatric sets;

(ix) Gastric lavage equipment;

(x) Drugs and supplies necessary for emergency care, including pediatric emergency care;

(xi) Capability for rapid infusion of fluids;

(xii) Capability for rapid fluid recovery and transfusion;

(xiii) X-ray capability with twenty-four hour coverage by in-house technician;

(xiv) Thermal control equipment for:

(A) Patient;

(B) Blood;

(xv) Two-way radio linked with EMS/TC vehicles;

(xvi) Pneumatic anti-shock garments, all sizes; EXCEPT, pediatric are sizes optional depending on local protocol;

(xvii) Cervical injury immobilization device;

(xviii) Long-bone stabilization device;

(xix) Equipment specific to pediatric trauma care, including:

(A) Traction splint;

(B) Blood pressure cuffs in infant, child sizes;

(C) Foley catheters;

(D) Rigid cervical collars;

(E) Doppler;

(F) Infant scale for accurate weight measurement under twenty-five pounds;

(G) Backboard;

(H) Temperature controlled heating units, with/without open crib;

(I) Heating/cooling blankets;

(J) Heat lamp;

(K) Hypothermia thermometers;

(L) Expanded scale electronic thermometers;

(M) Device for assuring maintenance of infant warmth during evaluation and transport;

(N) Nasogastric/feeding tubes;

(O) Noninvasive BP monitor; and

(P) Pulse oximetry.

(2) A level I trauma care hospital shall have a general surgery department including:

(a) An attending surgeon who is in-house and available upon the patient's arrival in the ED, assuming five minute prehospital notification. The attending surgeon shall:

(i) Be board certified; or have graduated from a residency program accredited by the accreditation council of graduate medical education, but who is less than five years out of training;

(ii) Have general surgery privileges;

(b) A post-graduate year four or above surgical resident may initiate evaluation and treatment upon the patient's arrival in the ED until the arrival of the attending surgeon. The resident shall have PALS or approved equivalent training.

(c) All trauma surgeons certified in ACLS; and

(d) All trauma surgeons trained in ATLS.

(3) A level I trauma care hospital shall have an operating suite with:

(a) An operating room adequately staffed and available within five minutes after notification;

(b) Essential personnel, including at least one OR nurse, readily available twenty-four hours a day;

(c) A documented method for prompt mobilization of consecutive operating room teams for trauma patients; and

(d) Equipment or capabilities including:

(i) Cardiopulmonary bypass capability;

(ii) Operating microscope;

(iii) Thermal control equipment for patients;

(iv) Thermal control equipment for blood;

(v) Rapid infusion capability;

(vi) Rapid fluid recovery capability; and

(vii) X-ray capability;

(viii) Bronchoscope in operating room;

(ix) Endoscopes available from elsewhere in the facility;

(x) Craniotome;

(xi) Monitoring equipment; and

(xii) Instruments and equipment appropriate to pediatric trauma care.

(4) A level I trauma care hospital shall have a post anesthetic recovery unit with:

(a) Essential personnel, including at least one nurse with critical post anesthetic nurse training, readily available twenty-four hours a day;

(b) All nurses ACLS certified; and

(c) Appropriate monitoring and resuscitation equipment.

(5) A level I trauma care hospital shall have an intensive care unit with:

(a) A medical director who is:

(i) Board certified or eligible in critical care, pulmonary medicine, cardiology or surgery;

(ii) ACLS certified; and

(iii) ATLS trained.

(b) A physician on duty in the ICU twenty-four hours a day, or who is in-house and available within five minutes;

(c) A physician directed code team;

(d) ICU registered nurses who:

(i) Are CCRN certified;

(ii) Are ACLS certified; and

(iii) Have taken a trauma life support course;

(e) Immediate access to clinical laboratory services;

(f) Equipment appropriate for adult and pediatric patients, including:

(i) Airway control and ventilation devices;

(ii) Oxygen source with concentration controls;

(iii) Cardiac emergency cart;

(iv) Temporary transvenous pacemaker;

(v) Electrocardiograph-cardiac monitor-defibrillator;

(vi) Cardiac output monitoring;

(vii) Electronic pressure monitoring;

(viii) Mechanical ventilator-respirators;

(ix) Patient weighing devices;

(x) Pulmonary function measuring devices;

(xi) Temperature control devices;

(xii) Drugs, intravenous fluids, and supplies; and

(xiii) Intracranial pressure monitoring devices.

(6) A level I trauma care hospital shall have a clinical laboratory available within five minutes, including:

(a) Standard analysis of blood, urine, and other body fluids;

(b) Coagulation studies;

(c) Blood gases and Ph determination;

(d) Serum and urine osmolality;

(e) Microbiology;

(f) Serum alcohol determination; and

(g) Drug screening.

(7) A level I trauma care hospital shall have transfusion services including:

(a) Blood and blood components available from in house or through community services, to meet patient needs in a timely fashion;

(b) Noncrossmatched blood available on patient arrival in ED;

(c) Massive transfusion protocols in place;

(d) Ability to perform massive transfusions and cell savers; and

(e) Blood storage capability.

(8) A level I trauma care hospital shall have radiological services, including:

(a) The following services in-house and available within five minutes:

(i) Computerized tomography; and

(ii) X-ray capability;

(a) The following services on-call and available within twenty minutes:

(i) Angiography;

(ii) Sonography; and

(iii) Nuclear scanning.

(9) A level I trauma care hospital shall have acute hemodialysis capability, or a written transfer agreement.

(10) A level I trauma care hospital shall have:

(a) A physician-directed burn unit which is staffed by nursing personnel trained in burn care; and is equipped to care for extensively burned patients; or

(b) Written transfer agreement with a burn center or hospital with burn unit.

(11) A level I trauma care hospital shall be able to manage acute head and/or spinal cord injury; or have written transfer agreements with a facilities that have such capabilities. Early transfer to an appropriate designated rehabilitation facility shall be considered.

(12) A level I trauma care hospital shall have a trauma rehabilitation coordinator; and

(a) A physician-directed rehabilitation medicine service which is staffed by personnel trained in rehabilitation care; and is equipped to care for the trauma patient; or

(b) Written agreements to transfer patients to a designated rehabilitation service when medically feasible.

#### NEW SECTION

WAC 246-976-520 DESIGNATION STANDARDS FOR LEVEL I TRAUMA CARE HOSPITALS—OUTREACH, TRAINING, AND PUBLIC EDUCATION. A level I trauma care hospital shall have:

(1) An outreach program with telephone and on-site consultations with physicians of the community and outlying areas regarding trauma care;

(2) Training, including:

(a) A formal program of continuing trauma care education for:

(i) Staff physicians;

(ii) Nurses;

(iii) Allied health care professionals;

(iv) Community physicians; and

(v) Prehospital personnel;

(b) An residency program accredited by the accreditation council of graduate medical education, committed to training physicians in trauma management;

(c) In-house initial and maintenance training of invasive manipulative skills for prehospital personnel;

(3) A public education program addressing:

(a) Injury prevention:

(i) In the home;

(ii) In industry and the work place;

(iii) On the highways;

(iv) On athletic fields; and

(v) For recreational or sports related activities.

(b) First aid or CPR;

(c) Problems confronting the public, the medical profession, and hospitals regarding optimal care for the injured.

#### NEW SECTION

WAC 246-976-550 DESIGNATION STANDARDS FOR LEVEL II TRAUMA CARE HOSPITALS—ADMINISTRATION AND ORGANIZATION. (1) For the purpose of administering trauma care, a designated level II hospital shall have a trauma service, including:

(a) Organization and direction by a general surgeon who is expert in, and committed to, care of the injured;

(b) A multidisciplinary trauma committee with input to hospital management, including:

(i) An emergency physician;

(ii) A ED registered nurse;

(iii) A trauma surgeon;

(iv) A neurosurgeon;

(v) An orthopaedic surgeon;

(vi) A pediatric physician;

- (vii) An anesthesiologist;
  - (viii) Director of intensive care unit; and
  - (ix) An intensive care registered nurse;
- (c) A trauma resuscitation team to provide initial evaluation and treatment.

(i) The team shall be organized and directed by a general surgeon who is expert in and committed to care of the injured, and who assumes responsibility for coordination of overall care of the trauma patient;

(ii) All members of the team, except the surgeon, shall be in-house and available within five minutes;

(iii) The surgeon shall be available upon the patient's arrival in the ED, assuming twenty minute prehospital notification; and shall assume responsibility for patient care upon the surgeon's arrival in the resuscitation area;

(iv) The team shall include an emergency physician:

(A) Responsible for activating the trauma resuscitation team, using an approved scoring system; and

(B) Responsible for providing team leadership and care for the trauma patient until the arrival of the surgeon in the resuscitation area;

(v) Other members of the team shall be as specified in the hospital's application for designation;

(d) Specific delineation of trauma surgery privileges by the medical staff.

(2) A level II trauma care hospital shall have an ED with established standards and procedures to ensure immediate and appropriate care for adult and pediatric trauma patients.

(3) A level II trauma care hospital shall have a surgery department, including:

(a) General surgery, including a trauma surgeon;

(b) Neurosurgery:

(i) In house and available within five minutes, by a neurosurgeon, surgeon, or other physician who has been judged competent by the neurologic consultants on staff to initiate measures to stabilize the patient, and to initiate diagnostic procedures; and

(ii) With a surgeon with neurosurgical privileges on-call and available within thirty minutes;

(c) The following services on-call and available within thirty minutes:

(i) Gynecologic surgery;

(ii) Obstetric surgery;

(iii) Orthopaedic surgery;

(iv) Otorhinolaryngologic/maxillofacial surgery capable of managing upper airway trauma; and

(v) Thoracic surgery.

(4) A level II trauma care hospital shall have nonsurgical specialties including:

(a) Anesthesiology, with an anesthesiologist who:

(i) Is ACLS certified; and

(ii) Is on-call and available on patient's arrival in ED, assuming a twenty minute prehospital notification;

(b) A radiologist on-call and available within twenty minutes; and

(c) The following services on-call and available within thirty minutes:

(i) Cardiology;

(c) Hematology;

(d) Internal medicine;

(e) Pathology; and

(f) Pediatrics.

(5) A level II trauma care hospital shall have a pediatric trauma policy that:

(a) Provides for initial stabilization and resuscitation for pediatric trauma patients, including ED and operating room interventions; and

(b) If it is not a level II pediatric trauma hospital, includes written provision to transfer the patient to designated level I and II pediatric trauma facilities.

(6) A level II trauma care hospital shall have an approved policy to divert patients to other designated facilities, based on its ability to manage each patient at a particular time.

(7) A level II trauma care hospital shall have a quality assurance program in accordance with WAC 246-976-880.

#### NEW SECTION

#### WAC 246-976-560 DESIGNATION STANDARDS FOR LEVEL II TRAUMA CARE HOSPITALS—BASIC RESOURCES

AND CAPABILITIES. (1) A level II trauma care hospital shall have an ED with:

(a) A physician director who is board certified or eligible in emergency medicine;

(b) Emergency physicians who are:

(i) Board certified or eligible in emergency medicine, or who are practicing emergency medicine as their primary practice with special competency in care of trauma patients;

(ii) In-house and available within five minutes to patient on arrival to ED;

(iii) ATLS trained;

(iv) ACLS certified;

(v) PALS or approved equivalent trained; and

(vi) Designated members of the trauma team;

(c) ED registered nurses who:

(i) Are ACLS certified;

(ii) Are PALS or approved equivalent trained;

(iii) Have taken a trauma life support course; and

(iv) Are in the ED and available to the patient within five minutes; with at least two RN's on duty per shift;

(d) Equipment for resuscitation and life support of adult and pediatric trauma patients, including:

(i) Airway control and ventilation equipment including:

(A) Airways;

(B) Laryngoscopes, including curved and straight;

(C) Endotracheal tubes of all sizes;

(D) Bag-mask resuscitator, all sizes;

(E) Sources of oxygen; and

(F) Mechanical ventilation;

(ii) Suction devices, including:

(A) Back up suction source;

(B) Pediatric and adult suction catheters; and

(C) Tonsil suction tip;

(iii) Electrocardiograph;

(iv) Cardiac monitor;

(v) Defibrillator, including pediatric paddles;

(vi) All standard apparatus to establish central venous pressure monitoring;

(vii) All standard intravenous fluids and administering devices for adult and pediatric patients, including intravenous catheters and intraosseous needles;

(viii) Sterile surgical sets for procedures standard for ED such as thoracostomy and cut down, including adult and pediatric sets;

(ix) Gastric lavage equipment;

(x) Drugs and supplies necessary for adult and pediatric emergency care;

(xi) Capability for rapid infusion of fluids;

(xii) Capability for rapid fluid recovery and transfusion;

(xiii) X-ray capability with twenty-four hour coverage by in-house technician;

(xiv) Thermal control equipment for:

(A) Patient; and

(B) Blood;

(xv) Two-way radio linked with EMS/TC vehicles;

(xvi) Pneumatic anti-shock garments, all sizes; EXCEPT, pediatric sizes are optional, depending on local protocol;

(xvii) Cervical injury immobilization device;

(xviii) Long-bone stabilization device;

(xix) Equipment specific to pediatric care, including:

(A) Traction splint;

(B) Blood pressure cuffs in infant, child, and toddler sizes;

(C) Foley catheters;

(D) Rigid cervical collars;

(E) Doppler;

(F) Infant scale for accurate weight measurement under twenty-five pounds;

(G) Backboard;

(H) Temperature controlled heating units with/without open crib;

(I) Heating/cooling blankets;

(J) Heat lamp;

(K) Hypothermia thermometers;

(L) Expanded scale electronic thermometers;

(M) Device for assuring maintenance of infant warmth during transport;

(N) Nasogastric/feeding tubes;

(O) Noninvasive BP monitor; and

(P) Pulse oximetry.



(2) A level II trauma care hospital shall have a general surgery department including:

(a) An attending surgeon who is in-house and available upon the patient's arrival in the ED, assuming twenty minute prehospital notification. The attending surgeon shall:

(i) Be board certified; or have graduated from a residency program accredited by the accreditation council of graduate medical education, but who is less than five years out of training;

(ii) Have general surgery privileges;

(b) A post-graduate year four or above surgical resident may initiate evaluation and treatment upon the patient's arrival in the ED until the arrival of the attending surgeon. The resident shall have PALS or approved equivalent training;

(c) All trauma surgeons trained in ATLS.

(3) A level II trauma care hospital shall have an operating suite with:

(a) An operating room adequately staffed and available within twenty minutes after notification;

(b) Essential personnel, including at least one OR nurse, readily available twenty-four hours a day;

(c) A documented method for prompt mobilization of consecutive operating room teams for trauma patients; and

(d) Equipment or capabilities including:

(i) Operating microscope;

(ii) Thermal control equipment for patients;

(iii) Thermal control equipment for blood;

(iv) Rapid infusion capability;

(v) Rapid fluid recovery capability; and

(vi) X-ray capability;

(vii) Bronchoscope in operating room;

(viii) Endoscopes available from elsewhere in the facility;

(ix) Craniotome;

(x) Monitoring equipment; and

(xi) Instruments and equipment appropriate to pediatric trauma care.

(4) A level II trauma care hospital shall have a post anesthetic recovery unit with:

(a) Essential personnel, including at least one nurse with critical post anesthetic nurse training, readily available twenty-four hours a day;

(b) Appropriate monitoring and resuscitation equipment.

(5) A level II trauma care hospital shall have an intensive care unit with:

(a) A medical director who is:

(i) Board certified, board eligible, or who has expertise in critical care, pulmonary medicine, cardiology, surgery, internal medicine, or anesthesiology, and

(iii) ACLS certified;

(b) A physician on duty in the ICU twenty-four hours a day, or who is in-house and available within five minutes;

(c) A physician directed code team;

(d) ICU registered nurses that:

(i) Are CCRN certified;

(ii) Are ACLS certified; or

(iii) Have taken a trauma life support course;

(e) Immediate access to clinical laboratory services;

(f) Equipment appropriate for adult and pediatric patients, including:

(i) Airway control and ventilation devices;

(ii) Oxygen source with concentration controls;

(iii) Cardiac emergency cart;

(iv) Temporary transvenous pacemaker;

(v) Electrocardiograph-cardiac monitor-defibrillator;

(vi) Cardiac output monitoring;

(vii) Electronic pressure monitoring;

(viii) Mechanical ventilator-respirators;

(ix) Patient weighing devices;

(x) Pulmonary function measuring devices;

(xi) Temperature control devices;

(xii) Drugs, intravenous fluids, and supplies; and

(xiii) Intracranial pressure monitoring devices.

(6) A level II trauma care hospital shall have clinical laboratory services available within five minutes, including:

(a) Standard analysis of blood, urine, and other body fluids;

(b) Coagulation studies;

(c) Blood gases and pH determination;

(d) Serum and urine osmolality;

(e) Microbiology;

(f) Serum alcohol determination; and

(g) Drug screening.

(7) A level II trauma care hospital shall have transfusion services including:

(a) Blood and blood components available from in-house or through community services, to meet patient needs in a timely fashion;

(b) Noncrossmatched blood available on patient arrival in ED;

(c) Massive transfusion protocols in place;

(d) Ability to perform massive transfusions and cell savers; and

(e) Blood storage capability.

(8) A level II trauma care hospital shall have radiological services, including:

(a) The following services on-call and available within twenty minutes:

(i) Computerized tomography; and

(ii) X-ray capabilities;

(b) The following services on-call and available within thirty minutes:

(i) Angiography; and

(ii) Sonography.

(9) A level II trauma care hospital shall have acute hemodialysis capability, or a written transfer agreement.

(10) A level II trauma care hospital shall have:

(a) A physician-directed burn unit which is staffed by nursing personnel trained in burn care; and is equipped to care for the extensively burned patient; or

(b) Written transfer agreement with a burn center or hospital with burn unit.

(11) A level II trauma care hospital shall be able to manage acute head and/or spinal cord injuries, or have written transfer agreements with facility with such capabilities. Early transfer to an appropriate designated rehabilitation center shall be considered.

(12) A level II trauma care hospital shall have a trauma rehabilitation coordinator; and

(a) A physician-directed rehabilitation medicine service which is staffed by personnel trained in rehabilitation care, and is equipped to care for the trauma patient; or

(b) Written agreements to transfer patients to a designated rehabilitation service when medically feasible.

#### NEW SECTION

WAC 246-976-570 DESIGNATION STANDARDS FOR LEVEL II TRAUMA CARE HOSPITALS—OUTREACH AND TRAINING. Level II trauma care hospitals shall:

(1) Have an outreach program with telephone and on-site consultations with physicians of the community and outlying areas regarding trauma care;

(2) Have a formal program of continuing trauma care education for:

(a) Nurses;

(b) Allied health care professionals; and

(c) Prehospital personnel;

(3) Make the facility available for initial and maintenance training of invasive manipulative skills for prehospital personnel.

#### NEW SECTION

WAC 246-976-600 DESIGNATION STANDARDS FOR LEVEL III TRAUMA CARE HOSPITAL—ADMINISTRATION AND ORGANIZATION. (1) For the purpose of administering trauma care, a designated level III hospital shall have a trauma service, including:

(a) Organization and direction by a general surgeon or other physician who is expert in, and committed to, care of the injured;

(b) A multidisciplinary trauma committee with input to hospital management, including:

(i) An emergency physician;

(ii) An ED registered nurse;

(iii) A trauma surgeon;

(iv) An orthopaedic surgeon;

(v) An anesthesiologist;

(vi) Director of intensive care unit; and

(vii) An intensive care registered nurse;

(c) A trauma resuscitation team to provide initial evaluation and treatment:

(i) The team shall be organized and directed by a general surgeon who is expert in and committed to care of the injured, and who assumes responsibility for coordination of overall care of the trauma patient. The surgeon shall be on-call and available within twenty minutes;

(ii) All members of the team, except the surgeon, shall be in-house and available within five minutes;

(iii) The team shall include an emergency physician:

(A) Responsible for activating the trauma resuscitation team, using an approved scoring system; and

(B) Responsible for providing team leadership and care for the trauma patient until the arrival of the surgeon in the resuscitation area;

(iv) Other members of the team shall be as specified in the hospital's application for designation.

(d) Specific delineation of trauma surgery privileges by the medical staff.

(2) A level III trauma care hospital shall have an ED with established standards and procedures to ensure immediate and appropriate care for adult and pediatric trauma patients.

(3) A level III trauma care hospital shall have a surgery department with:

(a) A trauma surgeon; and

(b) An attending surgeon who is on-call and available within thirty minutes, and:

(i) Has general surgery privileges;

(ii) Has ATLS training; EXCEPT this requirement shall not apply to board certified surgeons;

(4) A level III trauma care hospital shall have nonsurgical specialties including:

(a) Anesthesiology, with an anesthesiologist or nationally certified registered nurse anesthetist who is:

(i) On-call and available within twenty minutes;

(ii) ACLS certified; or

(b) The following services on-call and available within thirty minutes:

(i) Internal medicine; and

(ii) A radiologist.

(5) A level III trauma hospital shall have a pediatric trauma policy that:

(a) Provides for initial stabilization and resuscitation for pediatric trauma patients including ED and operating room interventions; and

(b) If it is not a level III pediatric hospital, includes written provision to transfer patients to designated level I, II, and III pediatric trauma facilities.

(6) A level III trauma hospital shall have an approved policy to divert patients to other designated facilities, based on its ability to manage each patient at a particular time.

(7) A level III trauma care hospital shall have a quality assurance program in accordance with WAC 246-976-880.

#### NEW SECTION

WAC 246-976-610 DESIGNATION STANDARDS FOR LEVEL III TRAUMA CARE HOSPITALS—BASIC RESOURCES AND CAPABILITIES. (1) A level III trauma care hospital shall have an ED with:

(a) A physician director;

(b) A physician in-house and available within five minutes of patient's arrival in the ED, who is:

(i) Experienced in the resuscitation and care of trauma patients;

(ii) ATLS trained;

(iii) ACLS certified; and

(iv) A designated member of the trauma team;

(c) ED registered nurses who:

(i) Are ACLS certified;

(ii) Are PALS or equivalent trained;

(iii) Have taken a trauma life support course; and

(iv) Are in the ED and available to the patient within five minutes;

(d) Equipment for resuscitation and life support of pediatric and adult trauma patients, including:

(i) Airway control and ventilation equipment including:

(A) Airways;

(B) Laryngoscopes, including curved and straight;

(C) Endotracheal tubes of all sizes;

(D) Bag-mask resuscitator, all sizes;

(E) Sources of oxygen; and

(F) Mechanical ventilation available to the patient within five minutes;

(ii) Suction devices, including:

(A) Back up suction source;

(B) Pediatric and adult suction catheters; and

(C) Tonsil suction tip;

(iii) Electrocardiograph;

(iv) Cardiac monitor;

(v) Defibrillator, including pediatric paddles;

(vi) All standard apparatus to establish central venous pressure monitoring;

(vii) All standard intravenous fluids and administering devices appropriate for adult and pediatric patients, including intravenous catheters and intraosseous needles;

(viii) Sterile surgical sets for procedures standard for ED such as thoracostomy and cut down, including both adult and pediatric sets;

(ix) Gastric lavage equipment;

(x) Drugs and supplies necessary for adult and pediatric emergency care;

(xi) Capability for rapid infusion of fluids;

(xii) X-ray capabilities, with a technician on-call and available within twenty minutes;

(xiii) Thermal control equipment for:

(A) Patient; and

(B) Blood;

(xiv) Two-way radio linked with EMS/TC vehicles;

(xv) Pneumatic anti-shock garments, all sizes; EXCEPT, pediatric sizes are optional, depending on local protocol;

(xvi) Cervical injury immobilization device;

(xvii) Long-bone stabilization device;

(xviii) Equipment specific to pediatric care, including:

(A) Traction splint;

(B) Blood pressure cuffs in infant, child sizes;

(C) Foley catheter;

(D) Rigid cervical collars;

(E) Doppler;

(F) Infant scale for accurate weight measurement under twenty-five pounds;

(G) Backboard;

(H) Temperature-controlled heating units with/without open crib available within five minutes;

(I) Heating/cooling blankets;

(J) Heat lamp;

(K) Hypothermia thermometers;

(L) Expanded scale electronic thermometers;

(M) Device for assuring maintenance of infant warmth during evaluation and transport;

(N) Nasogastric/feeding tubes;

(O) Noninvasive BP monitor; and

(P) Pulse oximetry.

(2) A level III trauma care hospital shall have an operating suite adequately staffed and available within twenty minutes after notification, with:

(a) Essential personnel, including at least one OR nurse, readily available twenty-four hours a day;

(b) A documented method for prompt mobilization of consecutive operating room teams for trauma patients; and

(c) Equipment or capabilities including:

(i) Thermal control equipment for patients;

(ii) Thermal control equipment for blood;

(iii) X-ray capability;

(iv) Bronchoscope in operating room;

(v) Endoscopes available from elsewhere in the facility;

(vi) Monitoring equipment; and

(vii) Instruments and equipment appropriate to pediatric trauma care.

(3) A level III trauma care hospital shall have a post anesthetic recovery unit with:

(b) Essential personnel, including registered nurses with ACLS certification, readily available twenty-four hours a day;

(c) Appropriate monitoring and resuscitation equipment.

(4) A level III trauma care hospital shall have an intensive care unit with:

(a) A medical director who is ACLS certified;

(b) A physician-directed code team;

(d) ICU registered nurses who:

(i) Are CCRN certified;

- (ii) Are ACLS certified;
- (iii) Have taken a trauma life support course;
- (e) Immediate access to clinical laboratory services;
- (f) Equipment appropriate for adult and pediatric patients, including:
  - (i) Airway control and ventilation devices;
  - (ii) Oxygen source with concentration controls;
  - (iii) Cardiac emergency cart;
  - (iv) Temporary transvenous pacemaker;
  - (v) Electrocardiograph-defibrillator;
  - (vi) Electronic pressure monitoring;
  - (vii) Mechanical ventilator-respirators available within five minutes;
  - (viii) Patient weighing devices;
  - (ix) Pulmonary function measuring devices;
  - (x) Temperature control devices; and
  - (xi) Drugs, intravenous fluids, and supplies.
- (5) A level III trauma care hospital shall have clinical laboratory services available within twenty minutes, including:
  - (a) Standard analysis of blood, urine, and other body fluids;
  - (b) Coagulation studies;
  - (c) Blood gases and pH determination;
  - (d) Microbiology; and
  - (e) Serum alcohol determination.
- (6) A level III trauma care hospital shall have transfusion services including
  - (a) Blood and blood components available from in-house or through community services, to meet patient needs in a timely fashion;
  - (b) Noncrossmatched blood available on patient arrival in ED;
  - (c) Massive transfusion protocols in place;
  - (d) Ability to perform massive transfusions and cell savers; and
  - (e) Blood storage capability.
- (7) A level III trauma care hospital shall have acute hemodialysis capability, or written transfer agreements.
- (8) A level III trauma care hospital shall have:
  - (a) A physician-directed burn unit staffed by nursing personnel trained in burn care, and equipped to care for extensively burned patients; or
  - (b) Written transfer agreements with burn centers or hospitals with burn units.
- (9) A level III trauma care hospital shall be able to manage acute head and/or spinal cord injuries, or have written transfer agreements with facilities with such capabilities. Early transfer to an appropriate designated rehabilitation facility shall be considered.
- (10) A level III trauma care facility shall have a trauma rehabilitation coordinator; and
  - (a) A physician-directed rehabilitation medicine service staffed by personnel trained in rehabilitation care; and equipped to care for the trauma patient; or
  - (b) Written agreements to transfer patients to a designated rehabilitation service when medically feasible.

**Reviser's note:** The typographical error in the above section occurred in the copy filed by the agency and appears in the Register pursuant to the requirements of RCW 34.08.040.

#### NEW SECTION

WAC 246-976-640 DESIGNATION STANDARDS FOR LEVEL IV TRAUMA CARE FACILITIES—ADMINISTRATION AND ORGANIZATION. For the purpose of administering trauma care, a designated level IV hospital shall:

- (1) Define a system for providing emergency care; and
- (2) Establish emergency care services consistent with community needs and within the facility's capabilities; and
- (3) Have a quality assurance program in accordance with WAC 246-976-880.

#### NEW SECTION

WAC 246-976-650 DESIGNATION STANDARDS FOR LEVEL IV TRAUMA CARE FACILITIES—RESOURCES AND CAPABILITIES. (1) A level IV trauma care hospital shall have an ED with:

- (a) A physician who is experienced in resuscitation and care of trauma patients, who is:
  - (i) On-call and available within twenty minutes;
  - (ii) ATLS trained; and
  - (iii) ACLS certified;

- (b) An ED registered nurse in house and available within five minutes, who:
  - (i) Is ACLS certified; and
  - (ii) Has taken a trauma life support course;
  - (c) Basic emergency services including:
    - (i) Assessment of the patient's condition, in person by a registered nurse, physician, physician's assistant, physician extender, or advanced registered nurse practitioner;
    - (ii) Determination of the nature and urgency of the patient's medical need, including the timing and place of care;
    - (iii) Immediate diagnosis and treatment of any life threatening condition, including procedures to minimize aggravation of the patient's condition during transport to another health care facility; and
    - (iv) Written transfer agreements with higher levels of designated trauma facilities;
  - (d) Equipment for resuscitation and life support of adult and pediatric trauma patients, including:
    - (i) Airway control and ventilation equipment including:
      - (A) Laryngoscope;
      - (B) Endotracheal tubes of all sizes;
      - (C) Bag-mask resuscitator;
      - (D) Sources of oxygen; and
      - (E) Suction devices;
    - (ii) Electrocardiograph;
    - (iii) Oscilloscope;
    - (iv) Defibrillator;
    - (v) All standard intravenous fluids and administering devices, including intravenous catheters and intraosseous needles;
    - (vi) Sterile surgical sets for procedures standard for ED;
    - (vii) Gastric lavage equipment;
    - (viii) Drugs and supplies necessary for adult and pediatric emergency care;
    - (ix) X-ray capability, with technician on-call and available within 20 minutes;
    - (x) Thermal control equipment for patient;
    - (xi) Two-way radio linked with EMS/TC vehicles;
    - (xii) Pneumatic anti-shock garments; EXCEPT, pediatric sizes are optional depending on local protocol;
    - (xiii) Cervical injury immobilization device;
    - (xiv) Long-bone stabilization device; and
    - (xv) Back board.
- (2) A level IV trauma care hospital shall have surgery capabilities, including:
  - (a) Adequate staff, including:
    - (i) A physician on-call and available within thirty minutes, who:
      - (A) Has surgical privileges;
      - (B) Is ACLS certified; and
      - (C) Is ATLS trained;
    - (ii) Anesthesiology, with an anesthesiologist or certified registered nurse anesthetist, who has ACLS certification, and is on-call and available within twenty minutes;
  - (b) An operating suite available within twenty minutes, equipped with:
    - (i) Thermal control equipment for patients;
    - (ii) X-ray capability;
    - (iii) Endoscopes available from elsewhere in the facility; and
    - (iv) Monitoring equipment.
  - (3) A level IV trauma care hospital shall have a post anesthetic recovery unit with appropriate monitoring and resuscitation equipment.
  - (4) A level IV trauma care hospital's shall have:
    - (a) An ICU which meets requirements for a designated level III trauma hospital as described in WAC 246-976-610, EXCEPT for availability of a mechanical ventilator-respirator and a temporary transvenous pacemaker; or
    - (b) Written agreements with appropriate facilities to transfer patients requiring intensive care.
- (5) A level IV trauma care hospital shall have a clinical laboratory readily available, including:
  - (a) Standard analysis of blood, urine, and other body fluids;
  - (b) Blood gases and pH determination;
  - (6) A level IV trauma care hospital shall have transfusion services including:
    - (a) Blood and blood components available from in-house or through community services, to meet patient needs in a timely fashion;
    - (b) Ability to perform massive transfusions, or written transfer agreements with facilities having such capability; and
    - (c) Blood storage capability.

(7) A level IV trauma care hospital shall be able to perform acute hemodialysis, or have written transfer agreements with facilities having such capability.

(8) A level IV trauma care hospital shall have:

(a) A physician-directed burn unit staffed by nursing personnel trained in burn care, and equipped to care for extensively burned patients; or

(b) Written transfer agreement with a burn center or hospital with burn unit.

(9) A level IV trauma care hospital shall be able to manage acute head and/or spinal cord injuries, or have written transfer agreements with facilities that have such capabilities. Early transfer to an appropriate designated trauma rehabilitation facility shall be considered.

(10) A level IV trauma care hospital shall have a trauma rehabilitation coordinator.

#### NEW SECTION

WAC 246-976-680 DESIGNATION STANDARDS FOR LEVEL V TRAUMA CARE FACILITIES—ADMINISTRATION AND ORGANIZATION. For the purpose of administering trauma care, a designated Level V trauma care facility shall:

(1) Have written policy and patient care procedures for providing emergency medical care, consistent with regional patient care procedures; and

(2) Establish emergency care services with a nature and scope consistent with community needs, the regional plan, and the facilities capabilities.

(3) Have an organized trauma care quality assurance program with:

(a) A special audit process for all trauma deaths;

(b) Participation in the state trauma registry as required in WAC 246-976-420; and

(c) A person identified as responsible for coordination of trauma registry activities.

(4) Participate in the regional trauma network quality assurance program as required in WAC 246-976-910.

#### NEW SECTION

WAC 246-976-690 DESIGNATION STANDARDS FOR LEVEL V TRAUMA CARE FACILITIES—BASIC RESOURCES AND CAPABILITIES. A level V trauma care facility shall have:

(1) A physician, physician assistant registered in accordance with chapter 18.71 RCW, or advanced registered nurse practitioner, on-call and available within twenty minutes, who has:

(a) ATLS training, or approved equivalent;

(b) Experience in resuscitation and care of trauma patients;

(2) Equipment for resuscitation and life support of adult and pediatric trauma patients, including:

(a) Airway control and ventilation equipment, including:

(i) Laryngoscope;

(ii) Endotracheal tubes of all sizes;

(iii) Bag-mask resuscitator;

(iv) Sources of oxygen; and

(v) Suction devices;

(b) Electrocardiograph;

(c) Cardiac monitor;

(d) Defibrillator;

(e) All standard intravenous fluids and administering devices, including intravenous catheters;

(f) Gastric lavage equipment;

(g) Drugs and supplies necessary for emergency care;

(h) Pneumatic anti-shock garment;

(i) Cervical injury immobilization device;

(j) Long-bone stabilization device; and

(k) Back board.

#### NEW SECTION

WAC 246-976-720 DESIGNATION STANDARDS FOR LEVEL I PEDIATRIC TRAUMA CARE HOSPITALS—ADMINISTRATION AND ORGANIZATION. (1) For the purpose of administering trauma care, a designated level I pediatric hospital shall have a trauma service, including:

(a) Organization and direction by a general surgeon who is expert in, and committed to, care of the injured child;

(b) A multidisciplinary trauma committee with input to hospital management, including:

(i) A pediatric emergency physician;

(ii) An ED registered nurse;

(iii) A trauma surgeon;

(iv) A neurosurgeon;

(v) An orthopaedic surgeon;

(vi) An anesthesiologist;

(vii) Director of pediatric intensive care service;

(viii) A pediatric intensive care registered nurse; and

(ix) A pediatric intensivist;

(c) A trauma resuscitation team to provide initial evaluation and treatment.

(i) The team shall be organized and directed by a surgeon who is expert in and committed to care of the injured child, and who assumes responsibility for coordination of overall care of the pediatric trauma patient.

(ii) All members of the team, including the surgeon, shall be in-house and available within five minutes.

(iii) The team shall include an emergency physician:

(A) Responsible for activating the trauma resuscitation team, using an approved scoring system; and

(B) Responsible for providing team leadership and care for the pediatric trauma patient until the arrival of the surgeon in the resuscitation area.

(iv) Other members of the team shall be as specified in the hospital's application for designation.

(v) The team shall work in conjunction with a pediatrics intensive care physician or pediatric emergency physician;

(d) Specific delineation of trauma surgery privileges by the medical staff.

(2) A level I pediatric trauma care hospital shall have an ED with established standards and procedures to ensure immediate and appropriate care for pediatric trauma patients.

(3) A level I pediatric trauma care hospital shall have a surgery department, including:

(a) General surgery in-house and available upon patient's arrival in the ED, assuming a five minute prehospital notification;

(b) Neurosurgery;

(i) In-house and available within five minutes, by a neurosurgeon, surgeon, or other physician who has been judged competent by the neurologic consultants on staff to initiate measures directed toward stabilizing the pediatric patient and to initiate diagnostic procedures; and

(ii) With a neurosurgeon on-call and available within thirty minutes.

(c) The following services on-call and available within thirty minutes:

(i) Cardiac surgery;

(ii) Microsurgery;

(iii) Gynecologic surgery;

(iv) Hand surgery;

(v) Ophthalmic surgery;

(vi) Oral/dental surgery;

(vii) Orthopedic surgery;

(viii) Otorhinolaryngologic surgery;

(ix) Plastic and maxillofacial surgery;

(x) Thoracic surgery; and

(xi) Urologic surgery.

(4) A level I pediatric trauma care hospital shall have non surgical specialties with special expertise in pediatric care, including:

(a) Anesthesiology, with an anesthesiologist who is:

(i) ATLS trained;

(ii) ACLS certified;

(iii) PALS or equivalent trained; and

(iv) In-house and available on patient's arrival in ED, assuming five minute prehospital notification;

(b) General pediatrics in house and available on patient's arrival in ED, assuming five-minute prehospital notification, with pediatricians who are:

(i) Board certified; and

(ii) PALS or equivalent trained;

(iii) These requirements may be met by a PL 2;

(c) The following services on-call and available within thirty minutes:

(i) Cardiology;

(ii) Chest medicine;

(iii) Gastroenterology;

(iv) Hematology/Pathology;

- (v) Infectious diseases;
  - (vi) Nephrology;
  - (vii) Neuro-radiology;
  - (viii) Pediatric cardiology;
  - (ix) Pediatric hematology/oncology;
  - (x) Pediatric pulmonology;
  - (xi) Psychiatry;
  - (xii) A radiologist; and
  - (xiii) Social work.
- (d) Pediatric neurology on-call and available within one hour;
- (5) A level I pediatric trauma care hospital shall have an approved policy to divert patients to other designated facilities, based on its ability to manage each patient at a particular time.
- (6) A level I pediatric trauma care hospital shall:
- (a) Have a quality assurance program in accordance with WAC 246-976-880; and
  - (b) Cooperate with regional trauma care quality assurance programs throughout the state established pursuant to WAC 246-976-910.

#### NEW SECTION

WAC 246-976-730 DESIGNATION STANDARDS FOR LEVEL I PEDIATRIC TRAUMA CARE HOSPITALS—RESOURCES AND CAPABILITIES. (1) A level I pediatric trauma care hospital shall have an ED with:

- (a) A physician director who is:
  - (i) Board certified or eligible in emergency medicine or pediatric emergency medicine;
  - (ii) ATLS trained;
  - (iii) ACLS certified; and
  - (iv) PALS or approved equivalent trained;
- (b) Emergency physicians who are:
  - (i) Board certified or eligible in emergency medicine, or pediatric emergency medicine, or in a specialty practicing emergency medicine as their primary practice with special competence in the care of the pediatric trauma patient;
  - (ii) In-house and available within five minutes of the patient's arrival in the ED;
    - (iii) ATLS trained;
    - (iv) ACLS certified;
  - (v) PALS or equivalent pediatric ALS trained; and
  - (vi) Designated members of the trauma team;
- (c) ED registered nurses who:
  - (i) Are ACLS certified;
  - (ii) Have completed a trauma life support course;
  - (iii) Are PALS or approved equivalent trained;
  - (iv) Are in the ED and available within five minutes;
- (d) An area designated for pediatric resuscitation, with equipment for resuscitation and life support of pediatric patients, including:
  - (i) Airway control and ventilation equipment including:
    - (A) Airways;
    - (B) Laryngoscopes, including curved and straight;
    - (C) Endotracheal tubes of all sizes;
    - (D) Bag-valve-mask resuscitator with all mask sizes;
    - (E) Sources of oxygen;
    - (F) Child and neonatal BVM resuscitation device designed to deliver 100% oxygen; and
    - (G) Mechanical ventilation;
  - (ii) Suction devices including:
    - (A) Back-up suction source;
    - (B) Pediatric suction catheters; and
    - (C) Tonsil suction tip;
  - (iii) Electrocardiograph-cardiac monitor-defibrillator appropriate to pediatric patients;
  - (iv) All standard apparatus to establish central venous pressure monitoring;
  - (v) All standard IV fluids and administering devices appropriate for pediatric patients, including:
    - (A) IV catheters;
    - (B) Intraosseous needles
    - (C) Infusion sets;
    - (D) Infusion pumps including micro-infusion capabilities;
    - (E) Infusion controllers; and
    - (G) Pediatric dosages/dilutions of medications; and
  - (vi) Sterile surgical sets appropriate for pediatric patients, for standard ED procedures including:
    - (A) Thoracostomy set;
    - (B) Chest tubes;

- (C) Tracheostomy set;
- (D) Spinal tap set;
- (E) Peritoneal lavage set; and
- (F) Cricothyrotomy set;
- (vii) Gastric lavage equipment;
- (viii) Drugs and supplies necessary for pediatric emergency care;
- (ix) X-ray capability with twenty-four hour coverage by in-house technicians;
- (x) Respiratory therapy available within five minutes;
- (xi) Two-way radio linked with EMS/TC vehicles;
- (xii) Pneumatic anti-shock garment, if included in local protocols for pediatric patients;
- (xiii) Skeletal traction device for cervical injuries;
- (xiv) Equipment specific to pediatric trauma care, including:
  - (A) Traction splint;
  - (B) Blood pressure cuffs in infant and child sizes;
  - (C) Foley catheters;
  - (D) Rigid cervical collars;
  - (E) Doppler;
  - (F) Infant scale for accurate weight measurement under twenty-five pounds;
  - (G) Backboard;
  - (H) Temperature controlled heating units with/without open crib;
  - (I) Heating/cooling blankets;
  - (J) Heat lamp;
  - (K) Hypothermia thermometers;
  - (L) Expanded scale electronic thermometers;
  - (M) Device for assuring maintenance of infant warmth during evaluation and transport;
  - (N) Nasogastric/feeding tubes;
  - (O) Noninvasive BP monitor; and
  - (P) Pulse oximetry.
- (2) A level I pediatric trauma care hospital shall have a general surgery department including:
  - (a) An attending surgeon who is in-house and available upon the patient's arrival in the ED, assuming five minute prehospital notification. The attending surgeon shall:
    - (i) Be board certified; or have graduated from a residency program accredited by the accreditation council of graduate medical education, but who is less than five years out of training;
    - (ii) Have PALS or approved equivalent training;
    - (iii) Be ATLS trained;
    - (iv) Have general surgery privileges;
  - (b) A post-graduate year four or above surgical resident may initiate evaluation and treatment upon the patient's arrival in the ED until the arrival of the attending surgeon. The resident shall have PALS or approved equivalent training;
  - (c) All trauma surgeons trained in ATLS.
- (3) A level I pediatric trauma care hospital shall have an operating suite with:
  - (a) An operating room adequately staffed and available within five minutes of notification;
  - (b) Essential personnel, including at least one OR nurse, available twenty-four hours a day;
  - (c) A documented method for prompt mobilization of consecutive operating room teams for pediatric trauma patients;
  - (d) Equipment or capabilities including:
    - (i) Cardiopulmonary bypass;
    - (ii) Operating microscope;
    - (iii) Thermal control equipment for patient;
    - (iv) Thermal control equipment for blood;
    - (v) X-ray capability;
    - (vi) Pediatric endoscopes/bronchoscopes;
    - (vii) Craniotomy set;
    - (viii) Monitoring equipment; and
    - (ix) Pediatric instruments and equipment.
- (4) A level I pediatric trauma care hospital shall have a postanesthetic recovery room or surgical intensive care unit with:
  - (a) Essential personnel, including at least one nurse with critical post anesthetic nurse training, readily available twenty-four hours a day;
  - (b) All nurses ACLS certified;
  - (c) Appropriate monitoring and resuscitation equipment.
- (5) A level I pediatric trauma care hospital shall have a pediatric intensive care unit exclusively for children, with:
  - (a) A medical director or co-director who is a board certified or eligible pediatric intensivist, with:

- (i) PALS or approved equivalent training;
  - (ii) Responsibility for coordinating the care of pediatric trauma patients, including:
    - (A) Development and implementation of policies;
    - (B) Supervision of resuscitation;
    - (C) Coordination of medical care;
    - (D) Determination of patient isolation;
    - (E) Ultimate authority for triage decisions;
    - (F) Maintenance of equipment;
    - (G) Coordination of staff education;
    - (H) Maintenance of statistics; and
    - (I) Reviewing quality of care on all pediatric trauma patients;
  - (c) A physician in-house and available within five minutes;
  - (d) A nurse manager responsible for training and coordination of nurses, physicians, and community agencies or services;
  - (e) Nurses with pediatric ALS certification;
  - (f) Patient isolation capacity; and
  - (g) Equipment appropriate for pediatric patients, including:
    - (i) Airway control and ventilation including:
      - (A) Airways;
      - (B) Child, infant and neonatal bag-mask resuscitators, able to deliver 100% oxygen;
      - (C) Endotracheal tubes with stylet;
      - (D) Infant and child laryngoscopes, curved and straight;
      - (E) Suction catheters; and
      - (F) Tonsil suction tip;
    - (ii) Oxygen source with concentration controls;
  - (iii) Cardiac emergency cart;
    - (iv) Temporary transvenous pacemaker;
    - (v) Electrocardiograph-cardiac monitor-defibrillator;
    - (vi) Electronic pressure monitoring;
    - (vii) Automated blood pressure apparatus;
    - (viii) Mechanical ventilator-respirator appropriate for entire pediatric spectrum including:
      - (A) Air/oxygen blenders; and
      - (B) Oxygen analyzers;
      - (ix) Patient weighing devices, including infant scale;
      - (x) Pulmonary function measuring devices;
      - (xi) Temperature control devices including:
        - (A) Temperature controlled heating units with/without open crib;
        - (B) Heating/cooling blankets; and
        - (C) Heat lamp;
      - (xii) Drugs, IV fluids and supplies including:
        - (A) Intravenous and intraosseous needles and catheters;
        - (B) Pediatric infusion sets;
        - (C) Pediatric dosages/dilutions;
        - (D) Infusion pumps;
        - (E) Infusion controllers; and
        - (F) IV fluid warmer;
      - (xiii) Spotlight;
      - (xiv) Doppler ultrasound BP device;
      - (xv) Suction machine;
      - (xvi) Refractometer;
      - (xvii) Otoscope/ophthalmoscope;
      - (xviii) Thermometers;
      - (xix) Pressor infuser pumps;
      - (xx) Portable EEG;
      - (xxi) Bedside EKG;
      - (xxii) Bedside echocardiography;
      - (xxiii) Bedside ultrasound;
      - (xxiv) Nuclear scan;
      - (xxv) Noninvasive oximetry and capnometry;
      - (xxvi) Portable transport monitor;
      - (xxvii) Specialized pediatric sets for thoracostomy, tracheostomy, spinal tap, cricothyroidotomy, and peritoneal lavage;
    - (xxviii) Foley catheters;
    - (xxix) Chest tubes;
    - (xxx) Capability for continuous monitoring of:
      - (A) EKG, heart rate;
      - (B) Respiration;
      - (C) Temperature;
      - (D) Arterial pressure; and
      - (E) Central venous pressure;
    - (xxxi) High/low alarms for heart rate, respiratory rate, and all pressures;
  - (xxxii) Provision for life support and cardiopulmonary monitoring; and
  - (xxxiii) Hard copy monitor recording capability.
- (6) A level I pediatric trauma care hospital shall designate a physician, who has an established relationship to the pediatric critical care team, to respond to pediatric airway emergencies. This requirement may be met by an emergency physician or an ICU physician.
- (7) A level I pediatric trauma care hospital shall have clinical laboratory services available within five minutes, including:
- (a) Micro-technique capability;
  - (b) Standard analyses of blood, urine and other body fluids;
  - (c) Blood typing and cross-matching;
  - (d) Coagulation studies;
  - (e) Comprehensive blood bank, or access to a community central blood bank and adequate hospital storage facilities;
  - (f) Blood gases and pH determination;
  - (g) Serum and urine osmolality;
  - (h) Microbiology;
  - (i) Serum alcohol determination; and
  - (j) Drug screening.
- (8) A level I pediatric trauma care hospital shall have radiological services, staffed and equipped including:
- (a) The following services in-house and available within five minutes:
    - (i) Routine radiological procedures; and
    - (ii) Computerized tomography;
  - (b) The following services on-call and available within thirty minutes:
    - (i) Angiography of all types;
    - (ii) Sonography;
    - (iii) Nuclear scanning;
    - (iv) Fluoroscopy;
    - (v) Contrast studies, including intravenous pyelograms, esophagrams, and barium enemas.
- (9) A level I pediatric trauma care facility shall have acute hemodialysis capability, or a written transfer agreement.
- (10) A level I pediatric trauma care hospital shall have:
- (a) A physician-directed burn unit which is staffed by nursing personnel trained in burn care, and equipped to care for extensively burned patients; or
  - (b) Written transfer agreement with a burn center or hospital with burn unit.
- (11) A level IV trauma care hospital shall be able to manage acute head and/or spinal cord injuries, or have written transfer agreements with facility that have such capabilities. Early transfer to a designated pediatric trauma rehabilitation facility shall be considered.
- (12) A level I pediatric trauma care hospital shall have respiratory therapy in-house and available within five minutes to the patient in the ED or ICU, with a therapist who has special pediatric training and/or experience.
- (13) A level I pediatric trauma care hospital shall have a trauma rehabilitation coordinator; and
- (a) A physician-directed pediatric rehabilitation medicine service which is staffed by nursing personnel trained in rehabilitation care, and is equipped to care for the pediatric trauma patient; or
  - (b) Written agreements to transfer patients to designated pediatric rehabilitation services when medically feasible.
- (14) A level I pediatric trauma care hospital shall have ancillary services including:
- (a) Pharmacy, with pharmacist in-house;
  - (b) Pediatric therapeutic recreation;
  - (c) Clergy or pastoral care;
  - (d) Social work, with social workers on-call and available within thirty minutes, and with written policies and procedures, including comprehensive case-finding mechanisms;
  - (e) Child protection services;
  - (f) Nutritionist services;
  - (g) Physical therapy services;
  - (h) Occupational therapy services.
- (15) A level I pediatric trauma care hospital shall have a heliport or landing zone located close enough to permit the facility to receive or transfer patients by air.

**Reviser's note:** The typographical error in the above section occurred in the copy filed by the agency and appears in the Register pursuant to the requirements of RCW 34.08.040.

**NEW SECTION****WAC 246-976-740 DESIGNATION STANDARDS FOR LEVEL I PEDIATRIC TRAUMA CARE HOSPITALS—OUT-REACH, TRAINING, RESEARCH AND PUBLIC EDUCATION.**

A level I pediatric trauma care hospital shall have:

- (1) An outreach program with telephone and on-site consultations with physicians in the community and outlying areas regarding trauma care;
  - (2) Training, including:
    - (a) A formal program of continuing trauma education for:
      - (i) Staff physicians;
      - (ii) Nurses;
      - (iii) Allied health care professionals;
      - (iv) Community physicians; and
      - (v) Prehospital personnel;
    - (b) An general surgery residency program accredited by the accreditation council of graduate medical education;
    - (c) In-house initial and maintenance training of invasive manipulative skills for prehospital personnel.
  - (3) A public education program addressing:
    - (a) Injury prevention;
    - (b) First aid;
    - (c) Problems confronting the public, medical profession, and hospitals regarding optimal care for the injured child;
  - (4) A pediatric trauma research program.

**NEW SECTION****WAC 246-976-770 DESIGNATION STANDARDS FOR LEVEL II PEDIATRIC TRAUMA CARE HOSPITALS—ADMINISTRATION AND ORGANIZATION.** (1) For the purpose of administering trauma care, a designated level II pediatric hospital shall have a trauma service, including:

- (a) Organization and direction by a general surgeon who is expert in, and committed to, care of the injured child;
- (b) A multidisciplinary trauma committee with input to hospital management, including:
  - (i) An emergency physician;
  - (ii) An ED registered nurse;
  - (iii) A trauma surgeon;
  - (iv) A neurosurgeon;
  - (v) An orthopaedic surgeon;
  - (vi) An anesthesiologist;
  - (vii) Director of pediatric intensive care service;
  - (viii) A pediatric intensive care registered nurse;
  - (ix) Pediatric intensivists; and
  - (x) Pediatric emergency physician;
- (c) A trauma resuscitation team to provide initial evaluation and treatment.
  - (i) The team shall be organized and directed by a trauma surgeon expert in, and committed to, care of the injured child, who assumes responsibility for coordination of overall care of the pediatric trauma patient.
  - (ii) The team shall work in conjunction with a pediatric intensive care physician or pediatric emergency physician.
  - (iii) All members of the trauma team, including the surgeon, shall be in-house and available within five minutes.
  - (iv) The team shall include an emergency physician:
    - (A) Responsible for activating the trauma resuscitation team, using an approved scoring system
    - (B) Responsible for providing team leadership and care of the pediatric trauma patient until the arrival of the surgeon in the resuscitation area.
  - (v) Other members of the team shall be as specified in the hospital's application for designation.
  - (d) Specific delineation of trauma surgery privileges by the medical staff.
    - (2) A level II pediatric trauma care hospital shall have an ED with established standards and procedures to ensure immediate and appropriate care for pediatric trauma patients.
    - (3) A level II pediatric trauma care hospital shall have a surgery department, including:
      - (a) General surgery, with a trauma surgeon in-house and available on the patient's arrival in the ED, assuming a five minute prehospital notification;
      - (b) Neurosurgery;

(i) In-house and available within five minutes, by a neurosurgeon, surgeon, or other physician who has been judged competent by the neurologic consultants on staff to initiate measures to stabilize the patient, and to initiate diagnostic procedures; and

(ii) With a neurosurgeon on-call and available within thirty minutes;

(c) The following services on-call and available within thirty minutes:

- (i) Ophthalmic surgery;
- (ii) Orthopedic surgery;
- (iii) Otorhinolaryngologic surgery;
- (iv) Plastic and maxillofacial surgery;
- (v) Thoracic surgery; and
- (vi) Urologic surgery.

(4) A level II pediatric trauma care hospital shall have nonsurgical specialty capabilities with pediatric expertise, including:

- (a) Anesthesiology, with an anesthesiologist who:
  - (i) Is PALS or equivalent trained; and
  - (ii) Is in-house and available within five minutes;
- (b) The following pediatric specialty services on-call and available within thirty minutes:
  - (i) Cardiology;
  - (ii) Chest medicine;
  - (iii) Gastroenterology;
  - (iv) Hematology/pathology;
  - (v) Infectious disease specialists;
  - (vi) Nephrology;
  - (vii) Neuro-radiology;
  - (viii) General pediatrics, with board-certified pediatricians who are PALS or equivalent trained;
  - (ix) A radiologist; and
  - (x) Social work.

(5) A level II pediatric trauma care hospital shall have an approved policy to divert patients to other designated facilities, based on its ability to manage each patient at a particular time.

(6) A level II pediatric trauma care hospital shall have a quality assurance program in accordance with WAC 246-976-880.

**NEW SECTION****WAC 246-976-780 DESIGNATION STANDARDS FOR LEVEL II PEDIATRIC TRAUMA CARE HOSPITALS—RESOURCES AND CAPABILITIES.** (1) A level II pediatric trauma care hospital shall have an ED with:

- (a) A physician director who is:
  - (i) Board certified or eligible in emergency medicine or pediatric emergency medicine;
  - (ii) ATLS trained; and
  - (iii) ACLS certified;
- (b) Emergency physicians who are:
  - (i) Board certified or eligible in emergency medicine, or pediatric emergency medicine, or in a specialty practicing emergency medicine as their primary practice with special competency in the care of the pediatric trauma patient;
  - (ii) In-house and available within five minutes;
  - (iii) ATLS trained;
  - (iv) ACLS certified;
  - (v) PALS or equivalent trained; and
  - (vi) Designated members of the trauma team;
- (c) ED registered nurses who:
  - (i) Are ACLS certified;
  - (ii) Have completed a trauma life support course;
  - (iii) Are PALS or approved equivalent trained;
  - (iv) Are in the ED and available to the patient within five minutes;
  - (d) A designated area for pediatric resuscitation with equipment for pediatric resuscitation and life support, including:
    - (i) Airway control and ventilation equipment including:
      - (A) Airways;
      - (B) Laryngoscopes, including curved and straight;
      - (C) Endotracheal tubes of all sizes;
      - (D) Bag-valve-mask resuscitator with all mask sizes, designed to deliver 100% oxygen;
    - (E) Sources of oxygen; and
    - (F) Mechanical ventilation;
  - (ii) Suction devices including:
    - (A) Back-up suction source;
    - (B) Suction catheters; and
    - (C) Tonsil suction tip;

- (iii) Electrocardiograph/cardiac monitor;
- (iv) Apparatus to establish central venous pressure monitoring;
- (v) All standard IV fluids and administering devices, including:
  - (A) IV catheters;
  - (B) Intraosseous needles
  - (C) Infusion sets;
  - (D) Infusion pumps including micro-infusion capabilities;
  - (E) Infusion controllers;
  - (F) Pediatric dosages/dilutions of medications; and
  - (G) IV fluid/blood warmer;
- (vi) Sterile surgical sets for procedures standard for EDs including:
  - (A) Thoracostomy set;
  - (B) Chest tubes;
  - (C) Tracheostomy set;
  - (D) Spinal tap set;
  - (E) Peritoneal lavage set; and
  - (F) Cricothyrotomy set;
- (vii) Gastric lavage equipment;
- (viii) Drugs and supplies necessary for pediatric emergency care;
- (ix) X-ray capability with twenty-four hour coverage by in-house technicians;
  - (x) Respiratory therapy available within five minutes;
  - (xi) Two-way radio linked with EMS vehicles;
  - (xii) Pneumatic anti-shock garment, if included in local pediatric protocols;
  - (xiii) Skeletal traction device for cervical injuries;
  - (xiv) Specialized pediatric equipment including:
    - (A) Traction splint;
    - (B) Blood pressure cuffs in infant, child sizes;
    - (C) Foley catheters;
    - (D) Rigid cervical collars in pediatric sizes;
    - (E) Doppler;
    - (F) Infant scale for accurate weight measurement under twenty-five pounds;
    - (G) Backboard;
    - (H) Temperature controlled heating units with/without open crib;
    - (I) Heating/cooling blankets;
    - (J) Heat lamp;
    - (K) Hypothermia thermometers;
    - (L) Expanded scale electronic thermometers;
    - (M) Device for assuring maintenance of infant warmth during evaluation and transport;
    - (N) Nasogastric/feeding tubes;
    - (O) Noninvasive blood pressure monitor; and
    - (P) Pulse oximetry.
- (2) A level II pediatric trauma care hospital shall have a general surgery department including:
  - (a) An attending surgeon who is in-house and available upon the patient's arrival in the ED, assuming twenty minute prehospital notification. The attending surgeon shall:
    - (i) Be board certified; or have graduated from a residency program accredited by the accreditation council of graduate medical education, but who is less than five years out of training;
    - (ii) Have general surgery privileges;
    - (b) A post-graduate year four or above surgical resident may initiate evaluation and treatment upon the patient's arrival in the ED until the arrival of the attending surgeon;
    - (c) All trauma surgeons trained in ATLS;
    - (d) All trauma surgeons trained in PALS or approved equivalent.
  - (3) A level II pediatric trauma care hospital shall have an operating suite adequately staffed and available within twenty minutes of notification. This requirement may be met by one RN who is in-house and available to the operating suite within five minutes, with the remainder of the staff on-call and available within twenty minutes. The operating suite shall have equipment appropriate for pediatric surgery, including:
    - (a) Thermal control equipment for patient;
    - (b) Thermal control equipment for blood;
    - (c) X-ray capability;
    - (d) Endoscopes/bronchoscopes; and
    - (e) Monitoring equipment.
  - (4) A level II pediatric trauma care hospital shall have a postanesthetic recovery room or surgical intensive care unit with:
    - (a) Essential personnel, including at least one nurse with critical post anesthetic nurse training, readily available twenty-four hours a day; and
    - (b) Appropriate monitoring and resuscitation equipment.
- (5) A level II pediatric trauma care hospital shall have a distinct pediatric intensive care service, including:
  - (a) A medical director or co-director who is board certified or eligible in pediatric intensive care, who has:
    - (i) PALS or approved equivalent training;
    - (ii) Responsibility for pediatric trauma care, including:
      - (A) Development and implementation of policies;
      - (B) Supervision of resuscitation;
      - (C) Coordination of medical care;
      - (D) Determination of patient isolation;
      - (E) Ultimate authority for triage decisions;
      - (F) Maintenance of equipment;
      - (G) Coordination of staff education;
      - (H) Maintenance of statistics; and
      - (I) Reviewing quality of care on all pediatric trauma patients;
    - (b) Patient isolation capacity;
    - (c) Pediatric intensive care nursing with:
      - (i) A pediatric nurse manager responsible for training and coordination of nurses, physicians, administration, and community agencies or services;
      - (ii) Nurses caring for pediatric trauma patients who have completed PALS or approved equivalent training; and
    - (d) Equipment appropriate for pediatric patients including:
      - (i) Airway control and ventilation including:
        - (A) Airways;
        - (B) Child and neonatal BVM designed to deliver 100% oxygen;
        - (C) Bag-mask resuscitators, all sizes;
        - (D) Endotracheal tubes with stylet;
        - (E) Infant and child laryngoscopes, curved and straight;
        - (F) Suction catheters; and
        - (G) Tonsil suction tip;
      - (ii) Oxygen source with concentration controls;
      - (iii) Cardiac emergency cart;
      - (iv) Temporary transvenous pacemaker;
      - (v) Electrocardiograph-cardiac monitor-defibrillator;
      - (vi) Electronic pressure monitoring;
      - (vii) Mechanical ventilator-respirator appropriate for entire pediatric spectrum including:
        - (A) Air/oxygen blenders;
        - (B) Oxygen analyzers;
      - (viii) Patient weighing devices, including infant scale;
      - (ix) Pulmonary function measuring devices;
      - (x) Temperature control devices including:
        - (A) Temperature controlled heating units with/without open crib;
        - (B) Heating/cooling blankets; and
        - (C) Heat lamp;
      - (xi) Drugs, IV fluids and supplies, including:
        - (A) Needles and catheters;
        - (B) Infusion sets;
        - (C) Infusion pumps;
        - (D) Infusion controllers; and
        - (E) IV fluid warmer;
      - (xii) Intraosseous needles and catheters;
      - (xiii) Spotlight;
      - (xiv) Doppler ultrasound BP device;
      - (xv) Suction machine;
      - (xvi) Refractometer;
      - (xvii) Otoloscope/ophthalmoscope;
      - (xviii) Thermometers;
      - (xix) Pressor infuser pumps;
      - (xx) Portable EEG;
      - (xxi) Bedside EKG;
      - (xxii) Noninvasive oximetry and capnometry;
      - (xxiii) Portable transport monitor;
      - (xxiv) Sets for thoracostomy, tracheostomy, spinal tap, cricothyroidotomy, and peritoneal lavage;
      - (xxv) Foley catheters;
      - (xxvi) Chest tubes;
      - (xxvii) Capability for continuous monitoring of:
        - (A) EKG, heart rate;
        - (B) Respiration;
        - (C) Temperature;
        - (D) Arterial pressure; and
        - (E) Central venous pressure;
      - (xxviii) High/low alarms for heart rate, respiratory rate, and all pressures;



(xxix) Provision for life support and cardiopulmonary monitoring; and

(xxx) Hard copy monitor recording capability.

(6) A level II pediatric trauma care hospital shall designate one or more physicians, who have an established relationship to the pediatric trauma resuscitation team, to respond to pediatric airway emergencies. This requirement may be met by an emergency physician or an ICU physician.

(7) A level II pediatric trauma care hospital shall have clinical laboratory services readily available twenty-four hours a day, including:

- (a) Laboratory technician in-house;
- (b) Micro-technique capability;
- (c) Standard analyses of blood, urine and other body fluids;
- (d) Blood typing and cross-matching;
- (e) Coagulation studies;
- (f) Comprehensive blood bank, or through access to a community central blood bank and adequate hospital storage facilities;
- (g) Blood gases and pH determination;
- (h) Serum and urine osmolality;
- (i) Microbiology;
- (j) Serum alcohol determination; and
- (k) Drug screening.

(8) A level II pediatric trauma care hospital shall have radiological services including:

- (a) Routine radiologic procedures in-house and available within five minutes;
- (b) Contrast studies including intravenous pyelograms, esophagrams, and barium enemas, on-call and available within twenty minutes;
- (c) The following services on-call and available within thirty minutes:

- (i) Angiography of all types;
- (ii) Sonography;
- (c) In-house computerized tomography; and
- (d) Fluoroscopy.

(9) A level II pediatric trauma care hospital shall have respiratory therapy with a trained therapist in-house.

(10) A level II pediatric trauma care hospital shall have a pharmacy, with pharmacist on-call and available within twenty minutes.

(11) A level II pediatric trauma care hospital shall have acute hemodialysis capability, or a transfer agreement.

(12) A level II pediatric trauma care hospital shall have:

(a) A physician-directed burn unit which is staffed by nursing personnel trained in burn care; and is equipped to care for extensively burned patients; or

(b) Written transfer agreement with a burn center or hospital with burn unit.

(13) A level II pediatric trauma care hospital shall be able to manage acute head and/or spinal cord injuries, or have written transfer agreements with a facility that has such capabilities. Early transfer to an appropriate designated rehabilitation facility shall be considered.

(14) A level II pediatric trauma care hospital shall have a nurse designated as trauma rehabilitation coordinator; and:

(a) A physician-directed rehabilitation medicine service which is staffed by nursing personnel trained in pediatric rehabilitation care; and is equipped to care for pediatric trauma patients; or

(b) Written agreements to transfer patients to a designated pediatric rehabilitation services when medically feasible.

(15) A level II pediatric trauma care hospital shall have ancillary services including:

- (a) Clergy or pastoral care;
- (b) Social work, with social workers on-call and available within thirty minutes, and with written policies and procedures including comprehensive case-finding mechanisms;
- (c) Child protection services;
- (d) Nutritionist services.
- (e) Physical therapy services.

(16) A level II pediatric trauma care hospital shall have a heliport or landing zone located close enough to permit the facility to receive or transfer patients by air.

#### NEW SECTION

WAC 246-976-790 DESIGNATION STANDARDS FOR LEVEL II PEDIATRIC TRAUMA CARE HOSPITALS—EDUCATION AND TRAINING PROGRAMS. A level II pediatric trauma care hospital shall have:

- (1) A public education program addressing:

(a) Injury prevention;

(b) Standard first aid;

(c) Problems confronting the public, medical profession, and hospitals regarding optimal care for the injured child;

(2) A formal program of continuing education provided by the facility for staff physicians, nurses, allied health personnel, community physicians, and prehospital personnel.

#### NEW SECTION

WAC 246-976-810 DESIGNATION STANDARDS FOR LEVEL III PEDIATRIC TRAUMA CARE HOSPITALS—ADMINISTRATION AND ORGANIZATION. (1) For the purpose of administering trauma care, a designated level III pediatric trauma care hospital shall have a trauma service including:

(a) Organization and direction by a general surgeon or physician expert in, and committed to, care of the injured child;

(b) A multidisciplinary trauma committee with input to hospital management, including:

- (i) An emergency physician;
- (ii) An ED registered nurse;
- (iii) A trauma surgeon;
- (iv) An anesthesiologist;
- (v) Director of pediatric intensive care unit;
- (vi) A pediatric intensive care registered nurse; and
- (vii) A pediatrician;

(c) A trauma resuscitation team to provide initial evaluation and treatment.

(i) The team shall be organized and directed by a surgeon who is expert in and committed to care of the injured child; who assumes responsibility for coordination of overall care of the pediatric trauma patient; and who is on-call and available within twenty minutes;

(ii) All members of the team, except the surgeon, shall be in-house and available within five minutes;

(iii) The team shall include an emergency physician:

(A) Responsible for activating the trauma resuscitation team, using an approved scoring system; and

(B) Responsible for providing team leadership and care for the trauma patient until the arrival of the surgeon in the resuscitation area;

(iv) Other members of the team shall be as specified in the hospital's application for designation.

(d) Specific delineation of trauma surgery privileges by the medical staff.

(2) A level III pediatric trauma care hospital shall have an ED with established standards and procedures to ensure immediate and appropriate care for pediatric trauma patients.

(3) A level III pediatric trauma care hospital shall have a surgery department that includes an attending surgeon who is on-call and available within twenty minutes; and

(a) Has general surgery privileges;

(b) Has PALS or equivalent training;

(c) Has ATLS training; EXCEPT this requirement shall not apply to board certified surgeons.

(4) A level III pediatric trauma care hospital shall have anesthesiology, by an anesthesiologist or certified registered nurse anesthetist, who is PALS or equivalent trained, and who is on-call and available within twenty minutes.

(5) A level III pediatric trauma care hospital shall have an approved policy to divert patients to other designated facilities, based on its ability to manage each patient at a particular time.

(6) A level III trauma care hospital shall have a quality assurance program in accordance with WAC 246-976-880.

#### NEW SECTION

WAC 246-976-820 DESIGNATION STANDARDS FOR LEVEL III PEDIATRIC TRAUMA CARE HOSPITALS—RESOURCES AND CAPABILITIES. (1) Level III pediatric trauma care hospitals shall have an ED with:

(a) A physician director who is:

(i) Board certified or eligible in emergency medicine or pediatric emergency medicine; or in a specialty practicing emergency medicine as their primary practice with special competency in the care of the pediatric trauma patient;

(ii) ATLS trained; and

(iii) ACLS certified;

(b) Emergency physicians who are:

- (i) Qualified and experienced in caring for pediatric patients with traumatic injuries;
- (ii) Capable of initiating resuscitation measures;
- (iii) In-house and available within five minutes;
- (iv) ATLS trained;
- (v) ACLS certified;
- (vi) PALS or equivalent trained; and
- (vii) Designated members of the trauma team;
- (c) ED registered nurses who are:
  - (i) ACLS certified;
  - (ii) ATLS trained;
  - (iii) PALS or approved equivalent trained; and
  - (iv) In-house and available within five minutes;
- (d) A designated area for pediatric resuscitation, with equipment for resuscitation and life support for the pediatric trauma patient, including:
  - (i) Airway control and ventilation equipment including:
    - (A) Airways;
    - (B) Laryngoscopes including curved and straight;
    - (C) Endotracheal tubes of all sizes;
    - (D) Bag-valve-mask resuscitator with all mask sizes;
    - (E) Sources of oxygen;
    - (F) Child and neonatal BVM resuscitation device designed to deliver 100% oxygen; and
    - (G) Mechanical ventilator;
  - (ii) Suction devices, including:
    - (A) Back-up suction source;
    - (B) Suction catheters; and
    - (C) Tonsil suction tip;
  - (iii) Electrocardiograph-cardiac monitor-defibrillator;
  - (iv) Standard IV fluids and administering devices, including:
    - (A) IV catheters;
    - (B) Intraosseous needles;
    - (C) Infusion sets;
    - (D) Infusion pumps including micro-infusion capabilities;
    - (E) Infusion controllers;
    - (F) IV fluid/blood warmer;
  - (v) Sterile surgical sets for pediatric ED procedures, including:
    - (A) Thoracostomy set;
    - (B) Chest tubes;
    - (C) Tracheostomy set;
    - (D) Spinal tap set;
    - (E) Peritoneal lavage set; and
    - (F) Cricothyrotomy set;
  - (vi) Gastric lavage equipment;
  - (vii) Drugs and supplies necessary for pediatric emergency care;
  - (viii) X-ray capability, with technician on-call and available within twenty minutes;
  - (ix) Two-way radio linked with vehicles of the EMS/TC system;
  - (x) Pneumatic anti-shock garment, if included in local pediatric protocols;
  - (xi) Specialized pediatric equipment including:
    - (A) Traction splint;
    - (B) Blood pressure cuffs in infant, child sizes;
    - (C) Foley catheters;
    - (D) Rigid cervical collars;
    - (E) Doppler;
    - (F) Infant scale for accurate weight measurement under twenty-five pounds;
    - (G) Backboard;
    - (H) Temperature controlled heating units with/without open crib;
    - (I) Heating/cooling blankets;
    - (J) Heat lamp;
    - (K) Hypothermia thermometers;
    - (L) Expanded scale electronic thermometers;
    - (M) Device for assuring maintenance of infant warmth during evaluation and transport; and
    - (N) Nasogastric/feeding tubes.
- (2) A level III pediatric trauma care hospital shall have an operating suite adequately staffed, equipped and available within twenty minutes of notification, with:
  - (a) Thermal control equipment for patient;
  - (b) Thermal control equipment for blood;
  - (c) X-ray capability; and
  - (d) Monitoring Equipment.

(3) A level III pediatric trauma care hospital shall have a post-anesthetic recovery room or surgical intensive care unit with appropriate monitoring and resuscitation equipment.

(4) A level III pediatric trauma care hospital shall have a pediatric intensive care service for trauma patients with:

- (a) A medical director;
- (b) Nurses with:
  - (i) PALS or approved equivalent training; and
  - (ii) Completion of a trauma life support course;
- (c) Immediate access to clinical laboratory services with micro-technique capabilities;
- (d) Equipment specific to infant/pediatric trauma care, including:
  - (i) Airway control and ventilation devices;
  - (ii) Oxygen source with concentration controls;
  - (iii) Cardiac emergency cart;
  - (iv) Temporary transvenous pacemaker;
  - (v) Electrocardiograph-cardiac monitor-defibrillator;
  - (vi) Mechanical ventilator-respirators;
  - (vii) Patient weighing devices;
  - (viii) Pulmonary function measuring devices;
  - (ix) Temperature control devices; and
  - (x) Drugs, IV fluids, and supplies.

(5) A level III pediatric trauma care hospital shall have clinical laboratory services available within twenty minutes, including:

- (a) Standard analyses of blood, urine and other body fluids;
  - (b) Blood typing and cross-matching;
  - (c) Coagulation studies;
  - (d) Comprehensive blood bank or access to a community central blood bank and adequate hospital storage facilities; and
  - (e) Blood gases and Ph determination.
- (6) A level III pediatric trauma care hospital shall have:
- (a) A physician-directed burn unit staffed by nursing personnel trained in burn care, and equipped to care for the extensively burned pediatric patient; or
  - (b) Written transfer agreement with a burn center or hospital with burn unit.

(7) A level III pediatric trauma care hospital shall be able to manage acute head and/or spinal cord injuries, or have written transfer agreements with facility with such capabilities. Early transfer to an appropriate designated rehabilitation facility shall be considered.

(8) A level III pediatric trauma care hospital shall have routine radiological capabilities available within five minutes.

(9) A level III pediatric trauma care hospital shall have a trauma rehabilitation coordinator to facilitate the pediatric trauma patient's access to a designated pediatric rehabilitation center; and

- (a) A physician-directed rehabilitation medicine service staffed by nursing personnel trained in pediatric rehabilitation; and equipped to care for pediatric trauma patients; or
- (c) Written agreements to transfer patients to a designated pediatric rehabilitation service when medically feasible.

(10) A level III pediatric trauma care hospital shall have ancillary services, including clergy/pastoral care, and child protection services.

(12) A level III pediatric trauma care hospital shall have a heliport or landing zone located close enough to permit the facility to receive or transfer patients by air.

**Reviser's note:** The typographical error in the above section occurred in the copy filed by the agency and appears in the Register pursuant to the requirements of RCW 34.08.040.

#### NEW SECTION

WAC 246-976-880 TRAUMA QUALITY ASSURANCE PROGRAMS FOR DESIGNATED TRAUMA CARE HOSPITALS. All designated trauma care services EXCEPT level V shall:

(1) Have a hospital-wide quality assurance program to reflect and demonstrate continuous quality improvement in the delivery of trauma care. The trauma care quality assurance program includes:

- (a) Regular in-house multidisciplinary trauma conferences, including:
  - (i) Comprehensive review of patient care throughout the patient's stay;
  - (ii) Participation of members of the trauma team;
  - (iii) Participation of the person responsible for coordination of trauma registry activities;
  - (iv) Feedback to staff and services involved; and
  - (v) Provision of reports to the regional quality assurance program;

- (b) Special audit processes for all trauma patients including trauma deaths, using a monitoring system including:
  - (i) Outcomes of care and service;
  - (ii) Evaluations;
  - (iii) Trends;
  - (iv) Indicators;
  - (v) Documented patient care assessments;
  - (vi) Standards of care and/or practice guidelines;
  - (vii) Comparison of adult and pediatric patient care outcomes in the same facility;
  - (viii) Review of the delivery of prehospital trauma care; and
  - (ix) Patient perspectives of care;
- (2) Document the trauma care quality assurance program's proceedings, findings, conclusions, recommendations, actions taken, and results of the actions taken, demonstrating that relevant findings are used to study and improve processes that affect trauma patient care;
- (3) Evaluate the results of the trauma quality assurance program and include them with the hospital's general quality assurance program;
- (4) Participate in the state trauma registry as required in WAC 246-976-420;
- (5) Identify a person to be responsible for coordination of trauma registry activities;
- (6) Participate in the regional trauma care quality assurance program required in WAC 246-976-910.

#### NEW SECTION

WAC 246-976-885 EDUCATIONAL AND CERTIFICATION REQUIREMENTS—DESIGNATED TRAUMA CARE SERVICE PERSONNEL. To allow for timely and orderly establishment of the trauma system, the department shall consider that education and/or certification requirements established in this chapter for physicians in the ED, and for nursing personnel in all units of a designated trauma care facility, have been met if:

- (1) Until July 1, 1994, twenty-five percent of personnel caring for trauma patients meet the educational and certification requirements of this chapter at the time of designation;
- (2) By July 1, 1995, fifty percent of personnel caring for trauma patients meet the educational and certification requirements of this chapter;
- (3) By July 1, 1996, seventy-five percent of personnel caring for trauma patients meet the educational and certification requirements of this chapter; and
- (4) By July 1, 1997, all personnel caring for trauma patients meet the educational or certification requirements of this chapter.

#### NEW SECTION

WAC 246-976-890 INTERHOSPITAL TRANSFER GUIDELINES. (1) All designated trauma services shall have written transfer agreements for the identification and transfer of patients with special care needs who meet interhospital transfer criteria.

(2) Transfer agreements shall include the responsibility of the transferring hospital and of the receiving hospital, and shall assign medical control during interhospital transfer.

(3) All designated trauma care facilities shall have written clinical protocols for the multidisciplinary trauma resuscitation team to manage:

- (a) Multiple system injuries;
- (b) Head injuries;
- (c) Spinal cord injuries;
- (d) Pediatric trauma;
- (e) Gravid patient with injuries;
- (f) Profound hypothermia;
- (g) Burn care;
- (h) Barotrauma.

#### SYSTEM ADMINISTRATION

#### NEW SECTION

WAC 246-976-910 EMS AND TRAUMA CARE SYSTEM REGIONAL QUALITY ASSURANCE PROGRAM. (1) The department shall:

- (a) Provide guidelines for regional EMS/TC system quality assurance to evaluate regional trauma care delivery, patient care outcomes, and compliance with the requirements of this chapter; and

- (b) Review and approve regional quality assurance activities.
- (2) Levels I, II and III trauma care facilities shall establish and participate in regional EMS/TC systems quality assurance programs.
- (3) The regional quality assurance program:
  - (a) Shall include at least one member of each designated facility's medical staff, an EMS provider, and a member of the EMS/TC regional council; and
  - (b) In regions with facilities jointly designated under WAC 246-976-470(3) (b), shall include at least one member who does not reside or work in the region.
- (4) The regional quality assurance program shall invite the MPD and all other health care providers and facilities providing trauma care in the region, including nondesignated facilities and nonverified pre-hospital services, to participate in the regional trauma quality assurance program.
- (5) The regional quality assurance program shall include a written plan for implementation including:
  - (a) Scope of all services offered in the region;
  - (b) On-going assessment of performance of the regional EMS and trauma care system, based on data supplied by the trauma registry and other sources, including:
    - (i) Trauma care delivery;
    - (ii) Patient care outcomes;
    - (iii) Unexpected deaths; and
    - (iv) Compliance with the requirements of chapter 70.168 RCW, and this chapter;
  - (c) Identification and analysis of trends, patient care outcomes, and other information, based on trauma registry data;
  - (d) Periodic assessment of data concerning aspects of patient care;
  - (e) Policies regarding confidentiality of data elements related to identification of provider's and facility's care outcomes, in accordance with chapter 70.168 RCW;
  - (f) Policies regarding confidentiality and release of patient care quality assurance committee minutes, records and reports in accordance with RCW 70.168.090(4). Information identifying individual patients shall not be publicly disclosed without the patient's consent;
  - (g) Policies regarding confidentiality of documentation of the results of inquiries involving patient care issues; and
  - (h) Provision for feedback to the department and the regional council on identified EMS/TC issues and concerns.

#### NEW SECTION

WAC 246-976-920 MEDICAL PROGRAM DIRECTOR. (1) The department shall:

- (a) In conjunction with the state EMS/TC Committee, evaluate, certify and terminate certification of MPDs for a county, group of counties, or cities with populations over four hundred thousand, in coordination with the recommendations of the local medical community and local EMS/TC council;
- (b) Withdraw certification of MPDs on receipt of written resignation;

(c) Defend and hold harmless MPDs, delegates, or agents for any act or omission committed or omitted in good faith in the performance of his or her duties.

(2) The MPD shall:

- (a) Be knowledgeable in the administration and management of prehospital emergency medical care and services;
- (b) Provide medical control and direction of EMS/TC certified personnel in their medical duties, by oral or written communication;
- (c) Develop and adopt written prehospital patient care protocols to direct EMS/TC certified personnel in patient care. These protocols shall be based upon the assessment of the patients' medical needs. The protocols shall meet or exceed state-wide minimum standards for trauma and other prehospital care services;
- (d) Establish protocols for storing, dispensing and administering controlled substances, in accordance with state and federal regulations and guidelines;

(e) Consult with the local and regional EMS/TC councils and emergency communications centers to develop and approve patient care procedures;

(f) Work within the parameters of the approved regional patient care procedures;

(g) Supervise training of all EMS/TC certified personnel;

(h) Develop protocols for special training described in WAC 246-976-040;

(i) Periodically audit the educational performance, skill maintenance, and field performance of EMS/TC certified personnel, for quality assurance purposes;

(j) Recommend to the department certification, recertification, or denial of certification of EMS/TC personnel;

(k) Recommend to the department disciplinary action to be taken against EMS/TC personnel, which may include modification, suspension, or revocation of certification;

(l) Review and make recommendations to the department for individuals applying for recognition or renewal of recognition as senior EMT instructors.

(3) In accordance with department policies and procedures, the MPD may:

(a) Delegate in writing any duties, other than those described above in subsection (2)(c), (j), and (k) of this section, to other physicians;

(i) The MPD shall notify the department in writing of the names and duties of individuals so delegated, within 14 days;

(ii) The MPD may remove delegated authority at any time, which shall be effective upon written notice to the delegate and the department;

(b) Delegate in writing duties relating to training, evaluation or examination of certified EMS/TC personnel, to qualified nonphysicians;

(c) Enter into EMS/TC medical control agreements with other MPDs; and

(d) Recommend denial of certification to the department for any student the MPD deems unable to function as an EMS provider, despite successful completion of MPD-approved training, evaluation, or examinations.

(4) The department may withdraw the certification of an MPD when:

(a) The MPD fails to maintain eligibility under this chapter;

(b) The MPD fails to perform the duties assigned under this chapter;

(c) The MPD demonstrates unwillingness or inability to perform duties under this chapter;

(d) The local EMS/TC council or the local medical community recommends revocation to the department.

#### NEW SECTION

WAC 246-976-930 GENERAL RESPONSIBILITIES OF THE DEPARTMENT. (1) The department shall establish:

(a) The minimum and maximum number of hospitals and health care facilities in the state and within each EMS/TC planning and service region that may provide designated trauma care services based upon approved regional EMS/TC plans;

(b) The minimum and maximum number of prehospital providers in the state and within each EMS/TC planning and service region that may provide verified trauma care services based upon approved regional EMS/TC plans.

(2) The department shall designate hospitals and health care facilities to provide designated trauma care services in accordance with needs identified in the state-wide EMS/TC plan.

(3) The department shall design and establish the state-wide trauma care registry as authorized in RCW 70.168.090.

(4) The department shall develop prehospital trauma triage procedures and interfacility transfer guidelines, for adult and pediatric patients, and review them biennially with the advice of the steering committee.

(5) The department shall create:

(a) An EMS/TC licensing and certification advisory committee of eleven members, and appoint members including a balance of physicians, one of whom is an MPD, and individuals regulated under RCWs 18.71.205 and 18.73.081, an administrator from a city or county EMS/TC system, a member of the steering committee, and one consumer. All members except the consumer shall be knowledgeable in specific and general aspects of EMS/TC. Members shall be appointed for a period of three years. The terms of those members representing the same field shall not expire at the same time;

(b) Regional EMS/TC councils and appoint members, including a balance of hospital and prehospital trauma care and EMS providers, local elected officials, consumers, local law enforcement representatives, local government agencies, physicians, EMS/TC educators and prevention specialists involved in the delivery of EMS/TC services recommended by the local EMS/TC councils within the region.

(6) The department shall develop standards and a process and schedule for biennial update of regional and state-wide planning.

(7) The department shall review, recommend changes to, and approve regional plans based on the requirements of this chapter and recommendations from the steering committee, and upon consideration of the needs of trauma patients whose care may require resources from more than one region and/or from adjacent states.

(8) The department shall develop and publish a state-wide EMS/TC plan that:

(a) Identifies state-wide EMS/TC objectives and priorities and identifies equipment, facility, personnel, training, prevention, and other needs required to create and maintain a state-wide EMS/TC system;

(b) Is formulated by incorporating the regional EMS/TC plans required under chapter 70.168 RCW;

(c) Shall be updated every two years and shall be made available to the state board of health in sufficient time to be considered in preparation of the biennial state health report required in RCW 43.20.050;

(d) Includes a state EMS/TC communication plan formulating the system based on regional plans and legislative intent. The communications system plan shall:

(i) Provide for a communication network to support medical control;

(ii) Establish guidelines for EMD training for all EMS dispatch personnel; and

(iii) Establish minimum communications equipment levels for licensed ambulance and aid vehicles;

(e) Provides for interagency coordination, administration and regulation of the statewide EMS/TC communications plan;

(9) From available funds, the department shall make EMS systems development grants to regional councils:

(a) To support regional EMS/TC council operations;

(b) To support regional council matching grant programs described in WAC 246-976-960 (1)(f), giving priority to achievement of minimum standards of this chapter, and other purposes and priorities established with the advice of the steering committee;

(10) The department shall review biennially:

(a) Rules, policies and standards for EMS/TC, with the advice of the steering committee;

(b) Rules and standards for licensure of services and vehicles, and for certification of EMS/TC personnel, with the advice of the L&C committee;

(c) Minimum response times for verified prehospital trauma care services, considering data available from the trauma registry and with the advice of the steering committee.

(11) The department shall develop a format for evaluating the performance of MPDs consistent with WAC 246-976-920.

(12) The department shall develop and maintain the trauma prevention and education program as an integral component of the EMS/TC system.

(13) The department may:

(a) Recognize as an affiliated EMS services those organizations which are not required to be licensed under chapter 18.73 RCW, but which are:

(i) Recommended for affiliation by the local EMS/TC council and the MPD;

(ii) Identified in the regional plan as part of the EMS/TC system;

(b) Approve pilot programs and projects which have:

(i) Stated objectives;

(ii) A specified beginning and ending date;

(iii) An identified way of measuring the outcome;

(iv) A review process;

(v) A work plan with a time line;

(vi) Consistency with regional and state plans;

(vii) If training of certified EMS/TC personnel involved, consistency with the requirements of WAC 246-976-040.

(c) Appoint a communications advisory committee, with members who are users of EMS/TC communications and providers of EMS/TC services.

#### NEW SECTION

WAC 246-976-940 STEERING COMMITTEE. The EMS/TC steering committee shall:

(1) Review and comment on the department's rules, policies, and standards for EMS/TC at least biennially;

(2) Review and comment on rules proposed by the department for EMS/TC;

(3) Review and comment on the department's budget for the EMS/TC system at least biennially;

(4) Advise the department regarding EMS/TC needs and proposed funding throughout the state;

(5) Review the regional EMS/TC plans and recommend changes to the department before the department adopts the plans;

(6) Advise the department on disbursement of grants to regional councils and nonprofit agencies for the development, implementation and enhancement of the EMS/TC system; and

(7) Review the department's prehospital triage guidelines and inter-facility transfer guidelines biennially.

#### NEW SECTION

WAC 246-976-950 LICENSING AND CERTIFICATION COMMITTEE. The Licensing and Certification Committee shall:

(1) Review and comment on proposed licensing and certification rules under chapters 18.71 and 18.73 RCW;

(2) Review and comment biennially on the department's EMS/TC rules and standards pertaining to licensure of vehicles and services, and to certification of individuals;

(3) Assist the department, at the department's request, to fulfill any duty or exercise any power under this chapter pertaining to EMS/TC licensing and certification.

#### NEW SECTION

WAC 246-976-960 REGIONAL EMERGENCY MEDICAL SERVICES AND TRAUMA CARE COUNCILS. (1) Regional councils shall:

(a) At least semi-annually, identify and analyze trends and patient care outcomes, based on trauma registry data provided by the department, to evaluate the EMS/TC system and its component subsystems;

(b) Develop and submit to the department regional EMS/TC plans to:

(i) Assess and analyze regional EMS/TC needs;

(ii) Identify personnel, agencies, facilities, equipment, training, prevention programs and education to meet regional and local needs;

(iii) Identify specific activities necessary to meet state-wide standards and patient care outcomes and develop a plan of implementation for regional compliance;

(iv) Establish and review agreements with regional providers necessary to meet state standards;

(v) Establish agreements with providers outside the region to facilitate patient transfer;

(vi) Include a regional budget identifying the amount, source and purpose of all gifts and payments;

(vii) Establish the number and level of facilities to be designated, consistent with department guidelines and based on availability of resources and the distribution of trauma within the region;

(viii) Identify the need for and recommend distribution and level of care of prehospital services, to assure adequate availability and avoid inefficient duplication and lack of coordination of prehospital services within the region;

(ix) Include other specific elements defined by the department;

(x) Identify EMS/TC services and resources currently available within the region;

(xi) Describe how the roles and responsibilities of the MPD are coordinated with those of the regional EMS/TC council;

(xii) Describe and recommend improvements in medical control communications and EMS/TC dispatch, with at least the elements of the state communication plan described in WAC 246-976-930

(1)(i)(iv); and

(xiii) Include a schedule for implementation;

(c) In developing or updating its plan:

(i) Seek and consider the recommendations of:

(A) Local EMS/TC Councils;

(B) Counties, cities, or other governmental bodies that have established an EMS/TC system by ordinance, resolution, interlocal agreement, or contract; and

(ii) Use the regional and state analyses provided by the department based on trauma registry data and other appropriate sources;

(d) Advise the department on matters relating to the delivery of EMS/TC within the region;

(e) Provide data required by the department to assess the effectiveness of the EMS/TC system;

(f) Provide matching grants from funds made available by the department. These funds shall:

(i) Not exceed fifty percent of the cost of the proposal for which the grant is made; EXCEPT, the department may waive or modify the matching requirement if it determines insufficient local funding exists

and the public health and safety would be jeopardized if the proposal were not funded;

(ii) Be made available to any public or private nonprofit agency which in the judgment of the council will best fulfill the purpose of the grant;

(iii) Be awarded to:

(A) Establish, develop, expand and improve the EMS/TC system;

(B) Purchase EMS/TC equipment;

(C) Provide training and continuing education for EMS/TC personnel;

(E) Research and development activities pertaining to EMS/TC;

(F) Develop, implement and evaluate prevention programs; or

(G) Accomplish other purposes as approved by the department;

(g) Adopt patient care procedures in consultation with the MPDs, local councils and emergency communications centers. The patient care procedures shall identify the level of medical care personnel to be dispatched to an emergency scene, procedures for triage of patients, the level of trauma care facility to first receive the patient, and the name and location of other trauma care facilities to receive the patient should an interfacility transfer be necessary. Procedures on interfacility transfer of patients shall be consistent with the transfer procedures in chapter 70.170 RCW, and:

(i) Identify types and expected volume of trauma that may exceed regional capabilities, taking into consideration resources available in other regions and adjacent states;

(ii) Include a description of activation of the trauma system.

(3) In areas where no local EMS/TC council exists, the regional EMS/TC council shall have all the authority, duties and responsibilities of the local council, as described in WAC 246-976-970.

(2) Regional councils may:

(a) Apply for, receive, and accept gifts and other payments, including property and service, from any governmental or other public or private entity or person;

(b) Use these funds for any activities related to the design, maintenance, or enhancements of the EMS/TC system in the region; or

(c) Establish regional standards in the plan, including response times for verified services, which exceed the minimum requirements of this chapter.

(3) An EMS/TC provider who disagrees with the regional plan may appeal to the steering committee before the department approves the plan.

**Reviser's note:** The typographical error in the above section occurred in the copy filed by the agency and appears in the Register pursuant to the requirements of RCW 34.08.040.

#### NEW SECTION

WAC 246-976-970 LOCAL EMERGENCY MEDICAL SERVICES AND TRAUMA CARE COUNCILS. (1) A county or group of counties may create a local EMS/TC council composed of representatives of hospital and prehospital trauma care and EMS providers, local elected officials, consumers, local law enforcement officials, local government agencies, physicians, and prevention specialists involved in the delivery of EMS/TC.

(2) Local EMS/TC councils shall:

(a) Review, evaluate, and provide recommendations to the regional EMS/TC council regarding the provision of EMS/TC in the region, and provide recommendations on the regional EMS/TC plan;

(b) Recommend individuals to the department for membership on the regional EMS/TC council;

(c) Participate with the MPD, emergency communication centers, and the regional EMS/TC council in the development of regional patient care procedures; and

(d) Review and make recommendations to the department for individuals applying for recognition or renewal of recognition as senior EMT instructors.

#### NEW SECTION

WAC 246-976-990 FEES AND FINES. (1) The department shall establish and publish a fee structure for applicants for designation as trauma care facilities, to help defray the costs to the department of inspections and review of applications. Such fees shall not be assessed to health care facilities applying to provide level IV and V trauma care services.

(2) The department may assess fines for ambulance or aid services failing to license within the specified periods. Delinquent fines shall be

\$100 for a service and \$25.00 per vehicle, and shall not exceed \$500.00.

#### REPEALER

The following chapter of the Washington Administrative Code is repealed:

- WAC 246-975-001 DECLARATION OF PURPOSE.
- WAC 246-975-010 DEFINITIONS.
- WAC 246-975-020 LICENSE(S) REQUIRED.
- WAC 246-975-030 LICENSE EXPIRATION DATES.
- WAC 246-975-040 LICENSE EXPIRATION DATES.
- WAC 246-975-050 DENIAL, SUSPENSION, REVOCATION OF LICENSE—NOTICE—ADJUDICATIVE PROCEEDING.
- WAC 246-975-060 AMBULANCE VEHICLE AND EQUIPMENT.
- WAC 246-975-070 EXTRICATION EQUIPMENT.
- WAC 246-975-080 VARIANCES.
- WAC 246-975-090 RADIO COMMUNICATIONS EQUIPMENT—AMBULANCE VEHICLE.
- WAC 246-975-100 FIRST AID VEHICLE AND EQUIPMENT.
- WAC 246-975-110 EXTRICATION EQUIPMENT.
- WAC 246-975-120 VARIANCES.
- WAC 246-975-130 AIR AMBULANCE SERVICES.
- WAC 246-975-140 RADIO COMMUNICATIONS EQUIPMENT.
- WAC 246-975-150 VARIANCES FROM THE REQUIREMENTS OF THIS CHAPTER.
- WAC 246-975-160 AMBULANCE OPERATOR, AMBULANCE DIRECTOR RECORD REQUIREMENTS.
- WAC 246-975-170 LIABILITY INSURANCE.
- WAC 246-975-180 FIRST AID VEHICLE OPERATOR, FIRST AID VEHICLE DIRECTOR REQUIREMENTS.
- WAC 246-975-190 PERSONNEL REQUIREMENTS.
- WAC 246-975-200 ADVANCED FIRST AID TRAINING.
- WAC 246-975-210 BASIC LIFE SUPPORT—EMERGENCY MEDICAL TECHNICIAN QUALIFICATIONS AND TRAINING.
- WAC 246-975-220 EMERGENCY MEDICAL TECHNICIAN TRAINING—COURSE CONTENT, REGISTRATION, AND INSTRUCTOR QUALIFICATIONS.
- WAC 246-975-230 EMERGENCY MEDICAL TECHNICIAN—CERTIFICATION AND RECERTIFICATION.
- WAC 246-975-240 EMERGENCY MEDICAL TECHNICIAN—RECIPROCITY AND CHALLENGES.
- WAC 246-975-250 EMERGENCY MEDICAL TECHNICIAN AND FIRST RESPONDER—SPECIALIZED TRAINING.
- WAC 246-975-260 EMERGENCY MEDICAL TECHNICIAN—SCOPE OF CARE AUTHORIZED—PROHIBITION.
- WAC 246-975-270 REVOCATION, SUSPENSION OR MODIFICATION OF CERTIFICATE.
- WAC 246-975-280 NOTICE OF DECISION—ADJUDICATIVE PROCEEDING.
- WAC 246-975-290 INSPECTIONS AND INVESTIGATIONS.
- WAC 246-975-300 FIRST RESPONDER QUALIFICATIONS AND TRAINING.
- WAC 246-975-310 FIRST RESPONDER TRAINING COURSE CONTENTS, REGISTRATION AND INSTRUCTOR QUALIFICATION.
- WAC 246-975-320 FIRST RESPONDER—CERTIFICATION AND RECERTIFICATION.
- WAC 246-975-330 RECERTIFICATION—GENERAL REQUIREMENTS.
- WAC 246-975-340 FIRST RESPONDER—RECIPROCITY, CHALLENGES AND REINSTATEMENT.
- WAC 246-975-350 FIRST RESPONDER—SCOPE OF CARE AUTHORIZED, PROHIBITED.
- WAC 246-975-360 FIRST RESPONDER—REVOCATION OR SUSPENSION OF CERTIFICATE.
- WAC 246-975-990 AMBULANCES AND FIRST-AID VEHICLES LICENSING AND INSPECTION FEES.

#### REPEALER

The following chapter of the Washington Administrative Code is repealed:

- WAC 246-977-001 DECLARATION OF PURPOSE.
- WAC 246-977-010 DEFINITIONS.
- WAC 246-977-020 MEDICAL PROGRAM DIRECTOR.
- WAC 246-977-030 PHYSICIAN'S TRAINED MOBILE INTRAVENOUS THERAPY TECHNICIAN—AIRWAY MANAGEMENT TECHNICIAN—MOBILE INTENSIVE CARE PARAMEDIC, SELECTION, GENERAL TRAINING, AND KNOWLEDGE STANDARDS.
- WAC 246-977-040 PHYSICIAN'S TRAINED MOBILE IV THERAPY TECHNICIAN—TRAINING AND KNOWLEDGE STANDARDS.
- WAC 246-977-050 PHYSICIAN'S TRAINED MOBILE AIRWAY MANAGEMENT TECHNICIAN—TRAINING AND KNOWLEDGE STANDARDS.
- WAC 246-977-060 PHYSICIAN'S TRAINED MOBILE INTENSIVE CARE PARAMEDIC—TRAINING AND KNOWLEDGE STANDARDS.
- WAC 246-977-070 TESTING.
- WAC 246-977-080 CERTIFICATION AND RECERTIFICATION.
- WAC 246-977-090 CERTIFICATION OF INDIVIDUALS WHO HAVE NOT COMPLETED A TRAINING COURSE CONDUCTED BY APPROVED TRAINING PHYSICIANS IN THE STATE OF WASHINGTON.
- WAC 246-977-100 REVOCATION, SUSPENSION OR MODIFICATION OF CERTIFICATE.
- WAC 246-977-110 NOTICE OF DECISION—ADJUDICATIVE PROCEEDING.

**WSR 92-15-035**  
**PERMANENT RULES**  
**DEPARTMENT OF ECOLOGY**  
 [Order 91-59—Filed July 8, 1992, 8:51 a.m.]

Date of Adoption: July 7, 1992.

Purpose: To implement the provisions of RCW 90.56.200 to establish onshore and offshore facility oil spill prevention plan requirements to minimize the likelihood that a facility oil spill will occur and provide improved protection of Washington waters.

Statutory Authority for Adoption: RCW 90.56.300, 90.56.200, and 90.56.310.

Pursuant to notice filed as WSR 92-06-087 on March 4, 1992.

Changes Other than Editing from Proposed to Adopted Version: A number of editorial and renumbering changes that do not change intent or meaning were made throughout the rule for clarification purposes. Additional changes follow:

WAC 173-180D-030, definition of "cargo vessel" was revised to delete the phrase "greater than." This change was made to conform with the new statutory definition as amended by ESHB 2389 of 1992; definition of "oil" or "oils" was revised to clarify that "oil mixed with wastes other than dredged spoil" included oil-contaminated ballast or bilge water; and definition of "passenger vessel" was revised to conform with the new statutory definition as amended by ESHB 2389 of 1992.

WAC 173-180D-060, subsection (4)(c) was amended to identify the Washington statewide master oil and hazardous substance spill contingency plan as one key example of the local, state, regional, tribal, and/or federal government prevention plans that a facility prevention plan should address; subsection (6) was revised to state that a prevention plan must be updated to establish

compliance with the Federal Oil Pollution Act of 1990 within thirty calendar days after federal deadlines for facility requirements under that act. This change clarifies that prevention plans due by January 1, 1993, are not expected to establish compliance with regulations not yet in effect; subsection (7) was revised to state that a prevention plan must be updated to establish compliance with state financial responsibility requirements within thirty calendar days after financial responsibility evidence is required by rules adopted pursuant to chapter 88.44 RWC. This change clarifies that prevention plans due by January 1, 1993, are not expected to establish compliance with regulations not yet in effect; subsection (8) was revised to state that a prevention plan must be updated to establish compliance with personnel certification requirements within thirty calendar days after certification is required by rules adopted under chapter 90.56 RCW. This change clarifies that prevention plans due by January 1, 1993, are not expected to establish compliance with regulations not yet in effect; subsection (9) was revised to state that a prevention plan must be updated to establish compliance with operations manual requirements within thirty calendar days after manual submittal is required by rules adopted pursuant to chapter 90.56 RCW. This change clarifies that prevention plans due by January 1, 1993, are not expected to establish compliance with regulations not yet in effect; subsection (10) was revised to add that the prevention plan must provide evidence of contingency plan approval or submittal; this change clarifies that prevention plans due by January 1, 1993, are not expected to demonstrate contingency plan approval if the plan submittal deadline has been met and the contingency plan is still under review by the Department of Ecology; the term "if applicable" was deleted from subsection (11)(a)(ii) and (iii), and replaced with the term "existing" to clarify that while the rule does not require a facility to develop programs to meet these two rule provisions, any existing program must be documented in the prevention plan; the term "if applicable" was deleted from subsection (12) and replaced with the term "existing." This change clarifies that while an adequate facility prevention plan will need to involve an adequate maintenance and inspection program, and must document the facility's existing program, the rule does not strictly require a facility to develop programs to meet all subsection (12) provisions; subsection (12)(a)(ii) was revised to replace the term "hydrostatic and other integrity testing" with "integrity testing . . .". This change was made to clarify that the prevention plan should document any type of tank and pipeline integrity testing that the facility conducts; subsection (12)(d) was revised to clarify that the facility must only be responsible to make available existing copies of maintenance and inspection records for the five year period prior to plan submittal, but that the plan shall provide for use of a system to maintain all such records over subsequent five year periods; the term "if applicable" was deleted from subsections (13) and (14). This change clarifies that while an adequate facility prevention plan will need to involve an adequate use of spill prevention and site security measures, the rule does not strictly require a facility to document existence of all

provisions of subsections (13) and (14); subsection (14)(d) was revised to clarify that prevention plan should identify any measures used by the facility to prevent third-party damages; subsection (15)(e) was revised to clarify that the facility only needs to provide existing information on past discharges for the period between July 1, 1987, and January 1, 1993, given that such recordkeeping was not required during that period; however, the plan must provide for use of a system to maintain such information over subsequent five year periods; and subsection (16)(a)(iii) was changed to allow for use of a licensed professional engineer in general, versus only one licensed in Washington. This change is consistent with the flexibility of another part of this provision, which also allows the facility to use "another individual which the department has deemed to have an acceptable level of expertise."

WAC 173-180D-070, subsection (3) was revised to clarify that a prevention plan shall not be reviewed against criteria developed under the facility operations and design standards rule until after that rule has been adopted; subsection (4)(d) was revised to clarify use of the term "hazards"; subsection (5) was changed to allow the Department of Ecology to perform an expedited review of a prevention plan if that plan was approved by a federal agency or other state using equal or greater approval criteria. This change is consistent in intent with the reciprocity provision in the related contingency plan rule, chapter 173-181 WAC, it promotes consistency and avoids duplication, yet safeguards against the event that a major plan flaw is not addressed by other review authorities; and a new subdivision (d) was added to subsection (6) to provide information that the Department of Ecology's decisions under this rule are reviewable in Superior Court.

WAC 173-180D-080, subsection (1) was revised to require a facility to locate copies of the plan within the facility to ensure that a copy of the plan is immediately accessible to all applicable facility personnel.

WAC 173-180D-085, noncompliance with state financial responsibility requirements developed under chapter 88.44 RCW was added under subsection (1)(a) as an example of a significant prevention plan change; subsection (1)(a)(v) and (vi) were combined and modified to clarify the definition of a substantial change involving situations which affect the level of risk of an oil spill at the facility; and subsection (5) was revised to allow for prevention plan review by the Department of Ecology following any spill at the facility, rather for only those spills for which the plan holder is found responsible (a fact sometimes difficult to quickly determine).

WAC 173-180D-090, subsection (2) was revised to clarify that other statutory penalties could be imposed in the case of noncompliance.

Effective Date of Rule: Thirty-one days after filing.

July 7, 1992

Fred Olson

Deputy Director

Chapter 173-180D WAC  
FACILITY OIL SPILL PREVENTION PLAN  
STANDARDS



**WAC**

173-180D-010	Purpose.
173-180D-020	Authority.
173-180D-030	Definitions.
173-180D-040	Applicability.
173-180D-050	Plan preparation.
173-180D-055	Plan format requirements.
173-180D-060	Plan content requirements.
173-180D-065	Plan submittal.
173-180D-070	Plan review.
173-180D-075	Inspections.
173-180D-080	Plan maintenance and use.
173-180D-085	Plan update timeline.
173-180D-090	Noncompliance with plan requirements.
173-180D-098	Severability.

**NEW SECTION**

**WAC 173-180D-010 PURPOSE.** The purpose of this chapter is to establish onshore and offshore facility oil spill prevention plan requirements which, when followed, will:

- (1) Minimize the likelihood that facility oil spills will occur;
- (2) Minimize the size and impacts of those facility oil spills which do occur;
- (3) Facilitate coordination of local, state, regional, tribal, and other prevention and contingency plans;
- (4) Provide improved protection of Washington waters and natural resources from the impacts of oil spills; and
- (5) Emphasize that oil spill prevention is the top priority strategy for protecting Washington waters and natural resources from the impacts of oil spills.

**NEW SECTION**

**WAC 173-180D-020 AUTHORITY.** RCW 90.56.200, 90.56.300, and 90.56.310 provide statutory authority for the prevention plan preparation and review requirements established by this chapter.

**NEW SECTION**

**WAC 173-180D-030 DEFINITIONS.** (1) "Best achievable protection" means the highest level of protection that can be achieved through the use of the best achievable technology and those staffing levels, training procedures, and operational methods that provide the greatest degree of protection achievable. The director's determination of best achievable protection shall be guided by the critical need to protect the state's natural resources and waters, while considering:

- (a) The additional protection provided by the measures;
- (b) The technological achievability of the measures; and
- (c) The cost of the measures.

(2) "Best achievable technology" means the technology that provides the greatest degree of protection, taking into consideration processes that are being developed, or could feasibly be developed, given overall reasonable expenditures on research and development, and processes that are currently in use. In determining what is best

achievable technology, the director shall consider the effectiveness, engineering feasibility, and commercial availability of the technology.

(3) "Bulk" means material that is stored or transported in a loose, unpackaged liquid, powder, or granular form capable of being conveyed by a pipe, bucket, chute, or belt system.

(4) "Cargo vessel" means a self-propelled ship in commerce, other than a tank vessel or a passenger vessel, of three hundred or more gross tons, including but not limited to, commercial fish processing vessels and freighters.

(5) "Department" means the state of Washington department of ecology.

(6) "Director" means the director of the state of Washington department of ecology.

(7) "Discharge" means any spilling, leaking, pumping, pouring, emitting, emptying, or dumping.

(8) (a) "Facility" means any structure, group of structures, equipment, pipeline, or device, other than a vessel, located on or near the navigable waters of the state that both:

(i) Transfers oil in bulk to or from a tank vessel or pipeline; and

(ii) Is used for producing, storing, handling, transferring, processing, or transporting oil in bulk.

(b) A facility does not include any:

(i) Railroad car, motor vehicle, or other rolling stock while transporting oil over the highways or rail lines of this state;

(ii) Underground storage tank regulated by the department or a local government under chapter 90.76 RCW;

(iii) Motor vehicle motor fuel outlet;

(iv) Facility that is operated as part of an exempt agricultural activity as provided in RCW 82.04.330; or

(v) Marine fuel outlet that dispenses three thousand gallons or less of fuel in a single transaction to a ship other than a tank vessel, cargo vessel, or passenger vessel. Marine fuel outlets that dispense more than three thousand gallons of fuel to any vessel in a single transaction do not meet this exemption.

(9) "Gross ton" means a vessel's approximate volume as defined in Title 46, United States Code of Federal Regulations, Part 69.

(10) "Marine facility" means any facility used for tank vessel wharfage or anchorage, including any equipment used for the purpose of handling or transferring oil in bulk to or from a tank vessel.

(11) "Maximum extent practicable" means the highest level of effectiveness that can be achieved through the use of facility personnel and best achievable technology. In determining what is the maximum extent practicable, the director shall consider, at a minimum, the effectiveness, engineering feasibility, commercial availability, safety, and the cost of the measures.

(12) "Navigable waters of the state" means those waters of the state, and their adjoining shorelines, that are subject to the ebb and flow of the tide and/or are presently used, have been used in the past, or may be susceptible for use to transport intrastate, interstate, or foreign commerce.



(13) "Offshore facility" means any facility, as defined in subsection (8) of this section, located in, on, or under any of the navigable waters of the state, but does not include a facility any part of which is located in, on, or under any land of the state, other than submerged land.

(14) "Oil" or "oils" means naturally occurring liquid hydrocarbons at atmospheric temperature and pressure coming from the earth, including condensate and natural gasoline, and any fractionation thereof, including, but not limited to, crude oil, petroleum, gasoline, fuel oil, diesel oil, oil sludge, oil refuse, and oil mixed with wastes other than dredged spoil, including oil-contaminated ballast or bilge water. Oil does not include any substance listed in Table 302.4 of 40 C.F.R. Part 302 adopted August 14, 1989, under section 101(14) of the Federal Comprehensive Environmental Response, Compensation, and Liability Act of 1980, as amended by P.L. 99-499.

(15) "Onshore facility" means any facility, as defined in subsection (8) of this section, any part of which is located in, on, or under any land of the state, other than submerged land, that because of its location, could reasonably be expected to cause substantial harm to the environment by discharging oil into or on the navigable waters of the state or the adjoining shorelines.

(16)(a) "Owner or operator" means:

(i) In the case of an onshore or offshore facility, any person owning or operating the facility; and

(ii) In the case of an abandoned onshore or offshore facility, the person who owned or operated the facility immediately before its abandonment.

(b) "Operator" does not include any person who owns the land underlying a facility if the person is not involved in the operations of the facility.

(17) "Passenger vessel" means a ship of three hundred or more gross tons with a fuel capacity of at least six thousand gallons carrying passengers for compensation.

(18) "Person" means any political subdivision, government agency, municipality, industry, public or private corporation, copartnership, association, firm, individual, or any other entity whatsoever.

(19) "Pipeline" means, for the purposes of subsection (8)(a)(i) of this section, a pipeline connected to a marine facility, and not owned or operated by the facility referred to in subsection (8)(a) of this section.

(20) "Plan" means oil spill prevention plan.

(21) "Ship" means any boat, ship, vessel, barge, or other floating craft of any kind.

(22) "Spill" means an unauthorized discharge of oil which enters waters of the state.

(23) "Tank vessel" means a ship that is constructed or adapted to carry, or that carries, oil in bulk as cargo or cargo residue, and that:

(a) Operates on the waters of the state; or

(b) Transfers oil in a port or place subject to the jurisdiction of this state.

(24) "Transporting" means, for the purposes of subsection (8)(b)(i) of this section, the act of moving oil over the highways or rail lines of this state, and the act of transferring oil to or from the rolling stock.

(25) "Waters of the state" includes lakes, rivers, ponds, streams, inland waters, underground water, salt

waters, estuaries, tidal flats, beaches and lands adjoining the seacoast of the state, sewers, and all other surface waters and watercourses within the jurisdiction of the state of Washington.

#### NEW SECTION

WAC 173-180D-040 **APPLICABILITY.** Oil spill prevention plans for onshore and offshore facilities must be prepared, submitted, and implemented, pursuant to requirements in this chapter.

#### NEW SECTION

WAC 173-180D-050 **PLAN PREPARATION.** (1) Each onshore and offshore facility shall prepare a plan for prevention of oil spills from the facility into the waters of the state, and for the protection of fisheries and wildlife, other natural resources, and public or private property from oil spills.

(2) Plans shall be thorough and contain enough information, analyses, supporting data, and documentation to demonstrate the plan holder's ability to meet the requirements of this chapter.

(3) Spill Prevention Countermeasure and Control Plans, Operation Manuals, and other prevention documents which meet federal requirements under 33 C.F.R. 154, 33 C.F.R. 156, 40 C.F.R. 109, 40 C.F.R. 112, or the Federal Oil Pollution Act of 1990 may be submitted to satisfy plan requirements under this chapter if the department deems that such federal requirements equal or exceed those of the department, or if the plans are modified or appended to satisfy plan requirements under this chapter.

(4) Plans which meet requirements of other states may be submitted to satisfy plan requirements under this chapter if the department deems that such state requirements equal or exceed those of the department, or if the plans are modified or appended to satisfy plan requirements under this chapter.

(5) Prevention plans may be combined with contingency plans required by chapter 173-181 WAC.

(6) Plans, when implemented, shall be designed to be capable of providing the best achievable protection from damages caused by the discharge of oil into the waters of the state. At a minimum, plans shall meet the criteria specified in this chapter.

#### NEW SECTION

WAC 173-180D-055 **PLAN FORMAT REQUIREMENTS.** (1) Plans shall be organized in a format which provides easy access to prevention information. Plans shall be divided into a system of chapters and sections. Chapters and sections shall be numbered and identified with a system of index tabs.

(2) Plans shall be formatted to allow replacement of chapter and appendix pages with revisions, without requiring replacement of the entire plan.

(3) If combined with a contingency plan, the prevention plan shall be clearly separated from contingency plan elements.

(4) Prevention plan content requirements specified in WAC 173-180D-060 are presented in suggested but not requisite order.

(5) Computerized plans, in addition to a hard copy, may be submitted to the department.

#### NEW SECTION

WAC 173-180D-060 PLAN CONTENT REQUIREMENTS. (1) Each plan shall contain a submittal agreement which:

(a) Includes the name, address, and phone number of submitting party;

(b) Verifies acceptance of the plan by the owner or operator of the facility by either signature of the owner or operator or signature by a person with authority to bind the corporation which owns or operates the facility;

(c) Commits the owner or operator of the facility to execution of the plan, and verifies that the plan holder is authorized to make appropriate expenditures in order to execute plan provisions; and

(d) Includes the name, location, and address of the facility, type of facility, starting date of operations, types of oil(s) handled, and oil volume capacity.

(2) Each plan shall include a log sheet to record amendments to the plan. The log sheet shall be placed at the front of the plan. The log sheet shall provide for a record of the section amended, the date that the old section was replaced with the amended section, verification that the department was notified of the amendment pursuant to WAC 173-180D-085, and the initials of the individual making the change. A description of the amendment and its purpose shall also be included in the log sheet, or filed in the form of an amendment letter immediately after the log sheet.

(3) Each plan shall include a detailed table of contents based on chapter, section, and appendix numbers and titles, as well as tables and figures.

(4) Each plan shall describe its purpose and scope, including but not limited to:

(a) The onshore facility or offshore facility operations covered by the plan;

(b) The relationship of the prevention plan to other oil spill plans and operation manuals held by the facility; and

(c) The relationship of the plan to all applicable local, state, regional, tribal, and federal government prevention plans, including the Washington State-wide Master Oil and Hazardous Substance Spill Contingency Plan.

(d) Information required under facility oil spill contingency plan standards in WAC 173-181-050(4); spill prevention, countermeasure, and control plan standards in 40 C.F.R. 112.4(a); or facility operations manual standards in 33 C.F.R. 154.310(1-4) may be used to address (a) of this subsection.

(5) Each plan shall describe the procedures and time periods for updating the plan and distributing the plan and updates to appropriate parties.

(6) Each plan shall establish that the facility is in compliance with the Federal Oil Pollution Act of 1990. Within thirty calendar days after federal deadlines for facility requirements under that act, the plan shall be

updated to include any applicable evidence of compliance.

(7) Within thirty calendar days after evidence of financial responsibility is required by rules adopted by the department pursuant to chapter 88.44 RCW, the plan shall be updated to include any applicable evidence of compliance.

(8) Each plan shall describe the types and frequency of spill prevention training provided to personnel. Within thirty calendar days after personnel certification is required by rules adopted by the department pursuant to RCW 90.56.220, the plan shall be updated to include any applicable evidence of compliance.

(9) Within thirty calendar days after submittal of an operations manual is required by rules adopted by the department pursuant to RCW 90.56.230, the plan shall be updated to include any applicable evidence of compliance.

(10) Each plan shall provide evidence that the facility has an approved oil spill contingency plan or has submitted a contingency plan to the department in accordance with standards and deadlines established by chapter 173-181 WAC.

(11) Each plan shall address the facility's alcohol and drug use awareness and treatment program for all facility personnel.

(a) The plan shall include at a minimum:

(i) Documentation of an alcohol and drug awareness program. The awareness program shall provide training and information materials to all employees on recognition of alcohol and drug abuse; treatment opportunities, including opportunities under the Alcohol and Drug Addiction Treatment and Support Act pursuant to chapter 388-40 WAC; and applicable company policies;

(ii) A description of the facility's existing drug and alcohol treatment programs; and

(iii) A description of existing provisions for the screening of supervisory and key employees for alcohol and drug abuse and related work impairment.

(b) Evidence of conformance with applicable federal "Drug-Free Workplace" guidelines or other federal or state requirements may be used to address (a) of this subsection.

(12) Each plan shall describe the facility's existing maintenance and inspection program.

(a) The description shall summarize:

(i) Frequency and type of all regularly scheduled inspection and preventive maintenance procedures for tanks; pipelines; other key storage, transfer, or production equipment, including associated pumps, valves, and flanges; and overpressure safety devices and other spill prevention equipment;

(ii) Integrity testing of storage tanks and pipelines, including but not limited to frequency; pressures used (including ratio of test pressure to maximum operating pressure, and duration of pressurization); means of identifying that a leak has occurred; and measures to reduce spill risk if test material is product;

(iii) External and internal corrosion detection and repair;

(iv) Damage criteria for equipment repair or replacement; and

(v) Any other aspect of the maintenance and inspection program.

(b) The plan shall include a current index of maintenance and inspection records of the storage and transfer facilities and related equipment.

(c) Documentation required under 40 C.F.R. 112.7(e) or 33 C.F.R. 154 Subparts C and D may be used to address elements of this subsection.

(d) Existing copies of the facility's maintenance and inspection records for the five-year period prior to plan submittal shall be maintained and shall be available for inspection if requested by the department. The plan shall document the use of a system to maintain such records over a five-year period for subsequent activity.

(13) Each plan shall describe spill prevention technology currently installed and in use, including:

(a) Tank and pipeline materials and design;

(b) Storage tank overflow alarms, low level alarms; tank overflow cut-off switches; automatic transfer shut-down systems; methods to alert operators; system accuracy; and tank fill margin remaining at time of alarm activation in terms of vertical distance, quantity of liquid, and time before overflow would occur at maximum pumping rate;

Documentation required under 40 C.F.R. 112.7(e)(2)(viii) or 33 C.F.R. 154.310(a)(12-13) may be used to address some or all of these elements;

(c) Leak detection systems for both active and nonactive pipeline conditions, including detection thresholds in terms of duration and percentage of pipeline flow; limitations on system performance due to normal pipeline events; and procedures for operator response to leak alarms;

Documentation required under 40 C.F.R. 112.7(e)(3) may be used to address some or all of these elements;

(d) Rapid pump and valve shutdown procedures, including means of ensuring that surge and over-pressure conditions do not occur; rates of valve closure; sequence and time duration (average and maximum) for entire procedure; automatic and remote control capabilities; and displays of system status for operator use;

Documentation required under 40 C.F.R. 112.7(e)(3) may be used to address some or all of these elements;

(e) Methods to minimize of post-shutdown residual drain-out from pipes, including criteria for locating valves; identification of all valves (including types and means of operation) that may be open during a transfer process; and any other techniques for reducing drain-out;

(f) Means of relieving pressure due to thermal expansion of liquid in pipes during quiescent periods;

(g) Secondary containment, including capacity, permeability, and material design;

Documentation required under 40 C.F.R. 112.7(e)(1) and (2)(iii-iv) may be used to address some or all of these elements;

(h) Internal and external corrosion control coatings and monitoring;

(i) Storm water and other drainage retention, treatment, and discharge systems, including maximum storage capacities and identification of any applicable discharge permits;

Documentation required under 40 C.F.R. 112.7(e)(1) and (2)(iii and ix) may be used to address some or all of these elements; and

(j) Criteria for suspension of operations while leak detection or other spill control systems are inoperative.

(14) Each plan shall describe measures taken to ensure facility site security, including:

(a) Procedures to control and monitor facility access;

(b) Facility lighting (documentation required under 33 C.F.R. 154.570 may be used to address some or all of this element);

(c) Signage; and

(d) Right-of-way identification or other measures to prevent third-party damage (documentation required under 40 C.F.R. 112.7(e)(3)(v) and (9) may be used to address some or all of this element).

(15) Each plan shall list any discharges of oil in excess of twenty-five barrels (one thousand fifty gallons) to the land or waters of the state which occurred during the five-year period prior to the plan submittal date. For each discharge, the plan shall describe:

(a) Quantity;

(b) Type of oil;

(c) Geographic location;

(d) Analysis of cause, including source(s) of discharged oil and contributing factors (e.g., third party human error, adverse weather, etc.); and

(e) Measures taken to remedy the cause and prevent a reoccurrence;

For the period between July 1, 1987, and January 1, 1993, the facility shall provide existing information regarding (a) through (e) of this subsection for such discharges, and shall document the use of a system to record complete information for subsequent discharges.

(16) Each plan shall include a detailed and comprehensive analysis of facility spill risks based on the information required in subsections (11) through (15) of this section, and other relevant information.

(a) The risk analysis shall:

(i) Evaluate the construction, age, corrosion, inspection and maintenance, operation, and oil spill risk of the transfer, production, and storage systems in the facility, including piping, tanks, pumps, valves, and associated equipment;

(ii) Evaluate spill minimization and containment systems within the facility;

(iii) Be prepared under the supervision of (and bear the seal of) a licensed professional engineer or another individual which the department has deemed to have an acceptable level of expertise.

(b) Documentation required under 40 C.F.R. 112.7(b) and (e) may be used to address some or all of the elements of this subsection.

(17) Each plan shall describe how the facility will incorporate those measures that will provide best achievable protection to address the spill risks identified in the risk analysis required in subsection (16) of this section.

(a) Information documented pursuant to 40 C.F.R. 112.7(e) and 33 C.F.R. 154.310 may be used to address some or all of these elements of this subsection.

(b) Within six months after facility operation standards are adopted by rule by the department pursuant to

RCW 90.56.220, the plan shall be updated to address how the facility will meet prevention standards and deadlines established by that rule.

(18) If the prevention plan is combined with a contingency plan, the prevention plan may incorporate information required in this section by reference if that information is provided in the contingency plan.

#### NEW SECTION

**WAC 173-180D-065 PLAN SUBMITTAL.** (1) Plans for onshore and offshore facilities shall be submitted to the department by January 1, 1993.

(2) Any onshore or offshore facility that first begins operating after the deadlines stated in subsection (1) of this section shall submit a plan to the department at least sixty-five calendar days prior to the beginning of operations.

(3) Three copies of the plan and appendices shall be delivered to:

Spill Management Section, Prevention Plan Review  
Washington Department of Ecology  
P.O. Box 47600  
Olympia, WA 98504-7600

(4) Onshore and offshore facility plans may be submitted by:

(a) The facility owner or operator; or

(b) A primary response contractor approved by the department pursuant to WAC 173-181-090, in conformance with signature requirements under WAC 173-180D-060(1).

(5) A single plan may be submitted for more than one facility, provided that the plan meets the requirements in this chapter for each facility listed.

(6) The plan submitter may request that proprietary information be kept confidential under RCW 43.21A.160.

#### NEW SECTION

**WAC 173-180D-070 PLAN REVIEW.** (1) The department shall endeavor to review each plan in sixty-five calendar days. If the plan is submitted in conjunction with a contingency plan required under chapter 173-181 WAC, the department may extend the prevention plan review period an additional sixty-five calendar days. Upon receipt of a plan, the department shall evaluate promptly whether the plan is incomplete. If the department determines that a plan is incomplete, the submitter shall be notified of deficiencies. The review period shall not begin until the department receives a complete plan.

(2) The department shall regularly notify interested parties of any prevention plans which are under review by the department, and make plans available for review by all department programs, other state, local, tribal, and federal agencies, and the public. The department shall accept comments on the plan from any interested party during the first thirty calendar days of review by the department.

(3) A plan shall be approved if, in addition to meeting criteria in WAC 173-180D-055 and 173-180D-060, it demonstrates that when implemented, it can:

(a) Provide best achievable protection from damages caused by the discharge of oil into the waters of the state;

(b) Minimize the likelihood that facility oil spills will occur;

(c) Minimize the size and impacts of those facility oil spills which do occur; and

(d) After the adoption of facility operation standards by rule by the department pursuant to RCW 90.56.220:

(i) Provide for compliance with prevention standards and deadlines established by facility operation standards adopted by rule by the department pursuant to RCW 90.56.220; and

(ii) Provide, to the maximum extent practicable, protection from oil spill risk factors identified in the risk analysis required by WAC 173-180D-060(16), for those risk factors not addressed by facility operation standards adopted by rule by the department pursuant to RCW 90.56.220.

(4) When reviewing plans, the department shall, in addition to the above criteria, consider the following at a minimum:

(a) The volume and type of oil(s) addressed by the plan;

(b) The history and circumstances of prior spills by similar types of facilities, including spill reports by ecology on-scene coordinators;

(c) Inspection reports;

(d) The presence of hazards unique to the facility, such as seismic activity or production processes;

(e) The sensitivity and value of natural resources within the geographic area covered by the plan; and

(f) Any pertinent local, state, tribal, federal agency, or public comments received on the plan.

(5) The department may approve a plan based upon an expedited review pursuant to criteria set out in this chapter, if that plan has been approved by a federal agency or other state which the department has deemed to apply approval criteria which equal or exceed those of the department.

(6) The department shall endeavor to notify the facility owner or operator within five working days after the review is completed whether the plan has been approved.

(a) If the plan receives approval, the facility owner or operator shall receive a certificate of approval describing the terms of approval, including expiration dates pursuant to WAC 173-180D-085(4).

(b) The department may conditionally approve a plan by requiring a facility owner or operator to operate with specific precautionary measures until unacceptable components of the plan are resubmitted and approved.

(i) Precautionary measures may include, but are not limited to, reducing oil transfer rates, increasing personnel levels, or restricting operations to daylight hours or favorable weather conditions. Precautionary measures may also include additional requirements to ensure availability of response equipment.

(ii) A plan holder shall have thirty calendar days after the department gives notification of conditional status to

submit to the department and implement required changes, with the option for an extension at the department's discretion. Plan holders who fail to meet conditional requirements or provide required changes in the time allowed shall lose conditional approval status.

(c) If plan approval is denied or revoked, the facility owner or operator shall receive an explanation of the factors for disapproval and a list of deficiencies. The facility shall not continue oil storage, transfer, production, or other operations until a plan for that facility has been approved.

(d) The department's decisions under this chapter are reviewable in superior court.

(e) If a plan holder demonstrates an inability to comply with an approved prevention plan or otherwise fails to comply with requirements of this chapter, the department may, at its discretion:

(i) Place conditions on approval pursuant to (b) of this subsection; or

(ii) Revoke its approval pursuant to (c) of this subsection.

(f) Approval of a plan by the department does not constitute an express assurance regarding the adequacy of the plan nor constitute a defense to liability imposed under state law.

(7) The department shall prepare a manual to aid department staff responsible for plan review. This manual shall be made available to plan preparers. While the manual will be used as a tool to conduct review of a plan, the department will not be bound by the contents of the manual.

(8) The department shall work with the office of marine safety to ensure that no duplication of regulatory responsibilities occurs in the review of prevention plans from marine facilities.

#### NEW SECTION

WAC 173-180D-075 INSPECTIONS. (1) The department may verify compliance with this chapter by announced and unannounced inspections in accordance with RCW 90.48.090.

(2) During inspections, department staff may require the plan holder to test operations of spill prevention technology installed in the facility.

(3) The department shall endeavor to provide a completed inspection report to the facility owner and operator within thirty calendar days from the inspection date.

#### NEW SECTION

WAC 173-180D-080 PLAN MAINTENANCE AND USE. (1) Each facility covered by the plan shall conspicuously locate copies of the plan within the facility to ensure that a copy of the plan is immediately accessible to all facility personnel involved in supervising or implementing oil handling operations.

(2) Facilities shall ensure that all employees involved in oil transfer, production, or storage operations are familiar with the plan provisions through regular training. Orientation materials for new employees involved in oil transfer, production, or storage operations shall contain a copy of the plan.

#### NEW SECTION

WAC 173-180D-085 PLAN UPDATE TIMELINE. (1) The department shall be notified in writing as soon as possible and prior to completion of any significant change which could affect the plan. If the change will reduce the facility's ability to implement the plan, the plan holder shall also provide a schedule for the return of the plan to full implementation capability.

(a) A significant change includes, but is not limited to:

(i) A change in the owner or operator of the facility;

(ii) A change in the types of oil handled at the facility;

(iii) A five percent or greater change in the facility's oil handling capacity;

(iv) Noncompliance with the Federal Oil Pollution Act of 1990;

(v) Noncompliance with state financial responsibility requirements developed under chapter 88.44 RCW; and

(vi) A substantial change in oil spill prevention technology installed at the facility, or other substantial changes to facility equipment, operations, personnel procedures, or any other change, including compliance with amended or new rules adopted by the department, which substantially affects the level of risk described pursuant to WAC 173-180D-060(16).

(b) Changes which are not considered significant include, but are not limited to, minor variations (less than five percent) in oil handling capacity, maintenance schedules, and operating procedures, provided that none of these changes will increase the risk of a spill.

(c) The facility shall update the plan's list of discharges, as required by WAC 173-180D-060(15), within thirty calendar days after an oil discharge by the facility in excess of twenty-five barrels (one thousand fifty gallons).

(d) A facsimile will be considered written notice for the purposes of this subsection.

(e) Failure to notify the department of significant changes shall be considered noncompliance with this chapter and subject to provisions of WAC 173-180D-070 (6)(e).

(2) If the department finds that, as a result of the change, the plan no longer meets approval criteria pursuant to WAC 173-180D-070, the department may, at its discretion, place conditions on approval or revoke approval in accordance with WAC 173-180D-070 (6)(e). The department may also require the plan holder to amend its plan to incorporate the change.

(3) Within thirty calendar days of making a change to the prevention plan, the facility owner or operator shall distribute the amended page(s) of the plan to the department and other plan holders.

(4) Plans shall be reviewed by the department at least every five years pursuant to WAC 173-180D-070. Plans shall be submitted for reapproval unless the plan holder submits a letter requesting that the department review the plan already in the department's possession. The plan holder shall submit the plan or such a letter at least sixty-five calendar days in advance of the plan expiration date.

(5) The department may review a plan following any spill at the facility.

#### NEW SECTION

**WAC 173-180D-090 NONCOMPLIANCE WITH PLAN REQUIREMENTS.** (1) Any violation of this chapter may be subject to the enforcement and penalty sanctions of RCW 90.56.300 and 90.56.310.

(2) In addition to other penalties, the department may assess a civil penalty of up to one hundred thousand dollars against any person who violates this section. Each day that a facility or person violates this section shall be considered a separate violation.

#### NEW SECTION

**WAC 173-180D-098 SEVERABILITY.** If any provision of this chapter is held invalid, the remainder of the rule is not affected.

**WSR 92-15-036**  
**PERMANENT RULES**  
**DEPARTMENT OF ECOLOGY**  
[Order 91-44—Filed July 8, 1992, 8:55 a.m.]

Date of Adoption: July 7, 1992.

Purpose: WAC 173-303-145 Spills and discharges, is being amended in response to a petition by the Federal Department of Energy.

Citation of Existing Rules Affected by this Order: Amending WAC 173-303-145.

Statutory Authority for Adoption: Chapters 70.105 and 70.105D RCW.

Pursuant to notice filed as WSR 92-11-040 on May 19, 1992.

Changes Other than Editing from Proposed to Adopted Version: During the past year ecology worked to draft language to amend WAC 173-303-145 of the dangerous waste regulations in order to improve the reporting requirements for spills and discharges of dangerous waste and hazardous substances to the environment. Following a year of work, which included consultation with industry, environmentalists, and an ecology technical advisory committee, a rule was drafted and presented for public review and comment in February 1992. The comments ecology received concerning this draft rule caused us to reconsider our approach. With the draft rule, we had attempted to take a comprehensive look at state-wide spill reporting needs; however, the draft rule was complex and its workability was questionable. The rule, if adopted as proposed, would result in new compliance requirements that would be inefficient for both industry and ecology. For these reasons, ecology has decided to return to the rule language that was in effect from 1986 to April 1991. This language required reporting of spills and discharges to the environment which impact public health and the environment. A focus sheet describing the return to the original rule language (pre April 1991) and brief guidance will be prepared by ecology to assist the regulated community in determining when spills should be reported. This guidance would include reference to

spills to surface water, the ground, and in some cases, to containment. The guidance will be distributed to all interested parties and hazardous waste generators and management facilities.

Effective Date of Rule: Thirty-one days after filing.

July 7, 1992

Fred Olson

Deputy Director

**AMENDATORY SECTION** (Amending Order 90-42, filed 3/7/91, effective 4/7/91)

**WAC 173-303-145 SPILLS AND DISCHARGES INTO THE ENVIRONMENT.** (1) Purpose and applicability. This section sets forth the requirements for any person responsible for a spill or discharge of a dangerous waste or hazardous substance into the environment, except when such release is otherwise permitted under state or federal law. For the purposes of complying with this section, a transporter who spills or discharges dangerous waste or hazardous substances during transportation will be considered the responsible person. This section shall apply when any dangerous waste or hazardous substance is intentionally or accidentally spilled or discharged into the environment (unless otherwise permitted) such that human health or the environment is threatened, regardless of the quantity of dangerous waste or hazardous substance.

(2) Notification. Any person who is responsible for a ~~((nonpermitted))~~ spill or nonpermitted discharge shall immediately notify the individuals and authorities described for the following situations:

(a) For spills or discharges onto the ground or into groundwater or surface water, notify all local authorities in accordance with the local emergency plan. If necessary, check with the local emergency service coordinator and the fire department to determine all notification responsibilities under the local emergency plan. Also, notify the appropriate regional office of the department of ecology;

(b) For spills or discharges which result in emissions to the air, notify all local authorities in accordance with the local emergency plan. If necessary, check with the local emergency service coordinator and the fire department to determine all notification responsibilities under the local emergency plan. Also, in western Washington notify the local air pollution control authority, or in eastern Washington notify the appropriate regional office of the department of ecology.

~~((c) Notify the appropriate regional office of the department of ecology in the following circumstances:~~

~~(i) For spills or discharges occurring outside of secondary containment meeting the requirements of this chapter, regardless of quantity, and~~

~~(ii) For spills or discharges occurring and contained in secondary containment meeting the requirements of this chapter, if the quantity of dangerous waste or hazardous substance meets or exceeds ten gallons.~~

~~(d) In lieu of notification under (c) of this subsection, for spills or discharges below ten gallons occurring and contained in secondary containment meeting the requirements of this chapter, a brief account must immediately be entered into the operating record, for a TSD~~

facility, or into the inspection log or separate spill log, for a generator. This account must include: The time and date of the spill, the location and cause of the spill, the type and quantity of material spilled, and a brief description of any response actions taken or planned.)

(3) Mitigation and control. The person responsible for a ~~((nonpermitted))~~ spill or nonpermitted discharge shall take appropriate immediate action to protect human health and the environment (e.g., diking to prevent contamination of state waters, shutting of open valves).

(a) In addition, ~~((the department may require))~~ the person responsible for a spill or discharge ~~((to))~~ shall:

(i) Clean up all released dangerous wastes or hazardous substances, or ~~((to))~~ take such actions as may be required or approved by federal, state, or local officials acting within the scope of their official responsibilities. This may include complete or partial removal of released dangerous wastes or hazardous substances as may be justified by the nature of the released dangerous wastes or hazardous substances, the human and environmental circumstances of the incident, and protection required by the Water Pollution Control Act, chapter 90.48 RCW;

(ii) Designate and treat, store or dispose of all soils, waters, or other materials contaminated by the spill or discharge in accordance with this chapter 173-303 WAC. The department may require testing in order to determine the amount or extent of contaminated materials, and the appropriate designation, treatment, storage, or disposal for any materials resulting from clean-up; and

(iii) If the property on which the spill or discharge occurred is not owned or controlled by the person responsible for the incident, restore the area impacted by the spill or discharge, and replenish resources (e.g., fish, plants) in a manner acceptable to the department.

(b) Where immediate removal or temporary storage of spilled or discharged dangerous wastes or hazardous substances is necessary to protect human health or the environment, the department may direct that removal be accomplished without a manifest, by transporters who do not have EPA/state identification numbers.

(4) Nothing in WAC 173-303-145 shall eliminate any obligations to comply with reporting requirements which may exist in a permit or under other state or federal regulations.

### WSR 92-15-037

#### PERMANENT RULES

#### STATE BOARD OF EDUCATION

[Filed July 9, 1992, 10:40 a.m.]

Date of Adoption: May 22, 1992.

Purpose: To eliminate requirements that have severely limited enrollment in the internship program; and to clarify appeal procedure to the State Board of Education.

Citation of Existing Rules Affected by this Order: Amending WAC 180-79-241, 180-86-150, and 180-86-155.

Statutory Authority for Adoption: RCW 28A.410.010.

Pursuant to notice filed as WSR 92-08-077 on March 31, 1992.

Effective Date of Rule: Thirty-one days after filing.

July 8, 1992

Dr. Monica Schmidt

Executive Director/Secretary

AMENDATORY SECTION (Amending WSR 91-05-056, filed 2/15/91, effective 3/18/91)

WAC 180-79-241 INTERNSHIP CERTIFICATE. In order to broaden the base of persons eligible to pursue teaching careers, the state board of education establishes a teaching internship certificate pilot project under the specific circumstances set forth below:

Internship certificate.

(1) Candidates shall be eligible for internship certificates which allow the holder full authority to serve as a part-time or full-time teacher and will be subject to the local school district's evaluation procedures under the following conditions:

(a) Persons must possess a master's degree and have a minimum of forty-five quarter hours (thirty semester hours) in an endorsement area or in a directly related area of study; or a bachelor's degree with a minimum of forty-five quarter hours (thirty semester hours) in an endorsement area or in a directly related area of study and at least five years of relevant work experience, subsequent to the bachelor's degree, as determined by the college or university;

(b) Candidates must be admitted to an approved Washington state college or university teacher education program, and hold a contract for employment as a teacher in a participating school district or be given written notice of other program or placement options if the candidate does not hold a contract. Candidates would be eligible for the internship certificate only upon completion of the college or university course work, as specified in subsection (2)(d) of this section, and employment in a participating school district.

(2) The college or university approved internship program shall be designed as follows:

(a) ~~((At least ten students must be enrolled at the time of the commencement of the program;~~

~~((b)))~~ Students shall proceed through the program as a cohort group;

~~((c)))~~ (b) The program shall be a minimum of forty-five quarter hours (thirty semester hours) of upper division and/or graduate study and must meet the state board of education standards for approved programs;

~~((d)))~~ (c) The program shall provide the intern a minimum of fifteen quarter hours (ten semester hours) of study prior to the beginning of the school year, five quarter hours (three semester hours) for each quarter/semester of the school year and fifteen quarter hours (ten semester hours) in the summer following the first year of teaching;

~~((e)))~~ (d) Prior to beginning teaching, the candidate must complete a minimum of fifteen quarter hours (ten semester hours) of course work in pedagogy including but not limited to: Child or adolescent psychology,



classroom management, methods instruction in the appropriate endorsement area, the legal responsibilities of the professional educator, reading in a content area, and the safety and supervision of children (the course work must include forty hours of observation of school students in learning situations);

((f)) (e) During each quarter/semester the interns shall participate in a college/university three hour seminar weekly in order to provide the interns with peer interaction and assistance on issues associated with their teaching experiences;

((g)) (f) The college/university shall assign a college supervisor to work with each intern;

((h)) (g) The school district shall assign a staff member to serve as a mentor (who shall be selected using the criteria established for the teacher assistance program) for each intern;

((i)) (h) The school district and the college/university shall specify in detail the resources they will provide and the procedures they will follow to assure that the intern is qualified to assume full-time responsibility when placed in the classroom as a teacher.

((j)) (i) The year of internship teaching shall be deemed comparable to the state board of education student teaching requirement, provided, the college/university evaluates the intern's teaching as satisfactory. The local school district evaluation of the intern shall be shared with the college/university in making its decision;

((k)) (j) The internship certificate shall be issued for one year and may be renewed only once for one additional year to persons who for good cause were unable to complete the program upon recommendation by the college or university where the person is enrolled in the teacher education program.

(3) At least one college/university and one school district that meet the following criteria shall be approved by the state board of education to conduct this pilot program:

(a) Colleges and universities and school districts wishing to participate in this program must submit joint proposals to the state board of education for its consideration, provided, one college/university may have joint agreements with more than one school district and may include within such agreements a cooperative arrangement with an educational service district.

(b) Colleges/universities and school districts shall submit a detailed description of the program based on the requirements in subsection (2) of this section, provided, the state board of education will consider modifications to the requirements if the proposal indicates how the intent of the program can be met in a different curricular design.

(4) The internship teaching program shall be reviewed annually by the respective professional education advisory board and evaluated by the professional education advisory committee during its third year of operation. After receiving the recommendation from the professional education advisory committee, the state board of education shall determine whether or not or under what circumstances the pilot project shall be continued.

(5) The pilot project shall terminate on August 31, 1995, unless the state board of education extends or revises the existing program.

**AMENDATORY SECTION** (Amending WSR 90-02-076, filed 1/2/90, effective 2/2/90)

WAC 180-86-150 APPEAL PROCEDURE—FORMAL SPI REVIEW PROCESS. Formal appeals to the superintendent of public instruction shall be provided as follows:

(1) Any person who has filed an appeal in accordance with WAC 180-86-140 and desires to have the decision of the review officer formally reviewed by the superintendent of public instruction may do so. To instigate review under this section, a person must file a written notice with the superintendent of public instruction within thirty calendar days following the date of receipt of the review officer's written decision.

(2) For purposes of hearing an appeal under this section, the superintendent of public instruction shall conduct a formal administrative hearing in conformance with the Administrative Procedure Act, chapter 34.05 RCW. The superintendent of public instruction, in carrying out this duty, may contract with the office of administrative hearings pursuant to RCW 28A.03.500 to hear a particular appeal. Decisions in cases formally appealed pursuant to this section may be made by the administrative law judge selected by the chief administrative law judge if the superintendent of public instruction delegates this authority pursuant to RCW 28A.03.500.

(3) The decision of the superintendent of public instruction or the administrative law judge, whichever is applicable, shall be sent by certified mail to the appellant's last known address and if the decision is to reprimand, suspend, or revoke, the appellant shall be notified that such order takes effect upon signing of the final order and that no stay of reprimand, suspension, or revocation shall exist until the appellant files an appeal in a timely manner pursuant to WAC ((180-75-033)) 180-86-155.

**AMENDATORY SECTION** (Amending WSR 90-02-076, filed 1/2/90, effective 2/2/90)

WAC 180-86-155 APPEAL PROCEDURE TO SBE. Any person whose application has been denied for any reason, who has been reprimanded, suspended, or whose certificate has been lapsed or revoked by the superintendent of public instruction in accordance with the procedures of this chapter may appeal that decision to the state board of education by filing a notice of appeal with the superintendent of public instruction or the secretary of the state board of education within thirty calendar days of the date of mailing the decision of the superintendent of public instruction. Review by the state board of education shall be conducted as follows:

(1) Review shall be conducted by the state board of education at its next scheduled meeting following notice of appeal unless either the appellant or the superintendent of public instruction requests an extension of the review to the following next scheduled meeting.



(2) Review conducted by the state board of education shall be confined to the record, except that in cases of alleged irregularities in procedures before the superintendent of public instruction, not shown in the record, testimony thereon shall be taken before the state board of education.

(3) The record shall include written briefs submitted.

(4) Oral argument will be permitted if fifteen days advance notice is given to the secretary of the state board of education.

(5) The state board of education will be assisted in its deliberations and its final order by an assistant attorney general who has not been involved in any prior proceeding related to the previous administrative order by the superintendent of public instruction.

(6) The state board of education may affirm the decision of the superintendent of public instruction, remand the matter for further proceedings, or reverse the decision.

(7) If the decision of the state board of education is to reverse the decision of the superintendent of public instruction or to remand the matter for further proceedings, the state board of education shall state its reasons in a written order.

(8) The final order of the state board of education shall be by written order, attested by the secretary of the state board of education, and sent to the appellant by certified mail within ten calendar days of the final decision by the state board of education. In addition, persons aggrieved by a final order shall be advised of their right to judicial review pursuant to RCW 34.05.570.

### WSR 92-15-038

#### EMERGENCY RULES

#### STATE BOARD OF EDUCATION

[Filed July 9, 1992, 10:42 a.m.]

Date of Adoption: May 22, 1992.

Purpose: To correct staff error of filing incorrect rules. This rule-making order shall supersede WSR 92-13-021 filed June 9, 1992. Adopted changes required to be consistent with changes in certification requirements enacted by the 1992 legislature (chapter 141, Laws of 1992).

Citation of Existing Rules Affected by this Order: Amending WAC 180-79-045, 180-79-060, 180-79-065, 180-79-115, 180-79-117, 180-79-122, 180-79-123, 180-75-127, and 180-75-085.

Statutory Authority for Adoption: RCW 28A.410.010.

Pursuant to RCW 34.05.350 the agency for good cause finds that immediate adoption, amendment, or repeal of a rule is necessary for the preservation of the public health, safety, or general welfare, and that observing the time requirements of notice and opportunity to comment upon adoption of a permanent rule would be contrary to the public interest.

Reasons for this Finding: WACs pertaining to the requirements associated with the required master's degree for initial certification need to be deleted or amended in

time for colleges and universities to make course and degree adjustments prior to the 1992-93 academic year.

Effective Date of Rule: Immediately.

June 12, 1992

Dr. Monica Schmidt

Executive Director/Secretary

#### AMENDATORY SECTION (Amending WSR 92-04-044, filed 1/31/92, effective 3/2/92)

WAC 180-75-085 GENERAL REQUIREMENTS—TEACHERS, ADMINISTRATORS, EDUCATIONAL STAFF ASSOCIATES. The following requirements are to be met by candidates for certification as teachers, administrators, or educational staff associates:

(1) Age. No person who is less than eighteen years of age shall receive a certificate to serve in the public or nonpublic schools of Washington state.

(2) Character. Applicants for certificates in Washington state who are not holders of a valid Washington state teacher's, administrator's, educational staff associate's, or vocational certificate must give evidence of good moral character and personal fitness as specified in WAC 180-75-082 and must ~~((make arrangements with the Washington state patrol for a background check as required by RCW 28A.410.010: PROVIDED, That applicants for vocational teaching certificates who do not make such an arrangement with the state patrol shall have placed on such certificates by the superintendent of public instruction a provision which restricts the certificate holder to the teaching of vocational technical institute students who are sixteen years of age or older))~~ complete a record check through the Washington state patrol criminal identification system and through the Federal Bureau of Investigation at the applicant's expense as required by RCW 28A.410.010; such record check shall include a finger print check using a Washington state patrol approved fingerprint card: PROVIDED, That the superintendent of public instruction may waive the record check for an applicant who has had a record check within the two years prior to application.

(3) Academic. A candidate for certification shall have successfully completed a state approved college/university professional preparation program and hold appropriate degrees, licenses, and additional course work as prescribed in chapter 180-79 WAC or have qualified under WAC 180-79-245: PROVIDED, That this section shall not apply to vocational, limited, internship, or instructional specialists certificates.

#### AMENDATORY SECTION (Amending WSR 90-12-075, filed 6/1/90, effective 7/2/90)

WAC 180-79-045 CERTIFICATES—PREVIOUS STANDARDS. (1) Certificates issued under previous standards which were issued for a specific term shall continue to be effective for that term. All persons who hold any standard teacher, administrator, or specialized personnel certificate issued under previous standards of the state board of education shall be issued a continuing certificate at such time as it is necessary for

them to reinstate a standard certificate or on application and payment of the fee as specified in WAC 180-75-065(1): **PROVIDED**, That ~~((until August 31, 1992,))~~ all persons who hold any provisional or initial certificate granted under previous standards of the state board of education shall be authorized to meet requirements for standard or continuing certification as set forth in the relevant previous standards so long as the standard or continuing certificate is obtained within six calendar years of the date on which the first provisional or initial certificate was issued; and, if such requirements are met, shall be issued a continuing certificate subject to the conditions of this chapter: **PROVIDED FURTHER**, That all persons who hold other than provisional or standard teaching certificates issued under standards of the state board of education adopted prior to 1971 shall be issued continuing certificates if they have completed forty-five quarter hours (thirty semester hours) of preparation past the baccalaureate degree and three years of experience: **PROVIDED FURTHER**, That any person holding a provisional certificate as a school nurse under provisions of chapter 180-84 WAC shall be granted a continuing certificate: **PROVIDED FURTHER**, That any person who holds a provisional principal's or provisional superintendent's certificate under previous standards of the state board of education shall be issued upon application, including payment of applicable fees, continuing administrative certificates with endorsements for such respective roles and such certificates shall be subject to the continuing education requirements of chapter 180-85 WAC.

(2) Except as noted in subsection (1) of this section, certificates issued under previous standards which were issued for an indefinite period shall continue to be in effect.

**AMENDATORY SECTION** (Amending WSR 90-12-075, filed 6/1/90, effective 7/2/90)

WAC 180-79-060 LEVELS OF CERTIFICATES. Two levels of certification may be issued:

(1) Initial certificate. The initial teacher certificate is valid for ~~((two))~~ four years and the initial administrator and educational staff associate certificates are valid for seven years. Initial teacher certificates shall be subject to renewal pursuant to WAC 180-79-065. Initial administrator and educational staff associate certificates shall not be subject to renewal~~((: PROVIDED, That initial teacher certificates issued or applied for, if the candidate is otherwise eligible, prior to August 31, 1992, shall be valid for four years))~~.

(2) Continuing certificate. The continuing certificate is valid on a continuing basis as specified in WAC 180-79-065(2).

**AMENDATORY SECTION** (Amending WSR 90-12-075, filed 6/1/90, effective 7/2/90)

WAC 180-79-065 INITIAL AND CONTINUING CERTIFICATES—APPLICABLE CONDITIONS. The following shall apply to initial and continuing certificates issued pursuant to this chapter:

(1) Initial certificate.

~~((a))~~ An ~~((initial teacher certificate issued prior to August 31, 1992, and an))~~ initial educational staff associate or administrator certificate issued prior to August 31, 1988, or an initial teacher certificate may be renewed for an additional three-year period on application and verification that the individual has completed all course work requirements for continuing certification or has completed at least fifteen quarter hours (ten semester hours) of course work since the certificate was issued or renewed.

~~((b) An initial teacher certificate issued on or after August 31, 1992 may be renewed for a three-year period by the applicant providing proof that he or she is enrolled in an approved masters degree program. A second renewal for a two-year period shall be granted if the candidate provides the following information from the degree granting institution:~~

~~(i) That the candidate has made substantial—i.e., fifty percent or more—progress toward the completion of an approved masters degree;~~

~~(ii) That the candidate has made satisfactory progress in the approved masters degree program;~~

~~(iii) That the candidate has made satisfactory arrangements to complete the approved masters degree program during the two-year extension period.))~~

(2) Continuing certificate.

(a) The continuing certificates of holders who were eligible for such certificates prior to August 31, 1987 and who applied for such certificates prior to July 1, 1988 or who would have been eligible for such certificates prior to August 31, 1987, but for one of the three-year experience requirement and who complete such requirement and apply for such certificate prior to August 31, 1988, will be valid for life. Holders of valid continuing certificates affected by this subsection shall be entitled to have such certificate reissued and subject to the terms and conditions applicable to certification at the time of reissuance including the continuing education requirements of chapter 180-85 WAC.

(b) All continuing certificates not affected by the exception stated in (a) of this subsection shall lapse if the holder does not complete the continuing education requirement specified in chapter 180-85 WAC. To reinstate such a lapsed continuing certificate the individual must complete the requirements for reinstatement stated within chapter 180-85 WAC.

**AMENDATORY SECTION** (Amending WSR 92-04-044, filed 1/31/92, effective 3/2/92)

WAC 180-79-115 ACADEMIC REQUIREMENTS FOR CERTIFICATION—TEACHERS. Candidates for teachers' certificates shall complete the following requirements in addition to those set forth in WAC 180-75-080 and 180-75-085.

(1) Initial.

(a) Candidates for the initial certificate who apply for such certificate on or before August 31, 1992, shall hold a baccalaureate degree from a regionally accredited college or university and shall have completed the degree major in an academic field or in the teaching specialization of early childhood, elementary, reading, or special education.

(b) Candidates for the initial certificate who apply for such certificate after August 31, 1992, shall hold an approved baccalaureate degree from a regionally accredited college or university: PROVIDED, That if the approved baccalaureate degree is in early childhood education, elementary education, or special education, the candidate also must have at least thirty quarter hours (twenty semester hours) in one of the academic fields listed in WAC 180-79-080 (3)(a) through (e) and (4).

(2) Continuing.

(a) Candidates who apply for a continuing certificate (~~on or before August 31, 1992,~~) shall have at least forty-five quarter hours (thirty semester hours) of upper division and/or graduate work completed subsequent to the conferral of the baccalaureate degree: PROVIDED, That if the individual is pursuing study in a new subject matter area or specialization, lower division courses in that subject area or specialization shall be accepted toward continuing certification upon completion of the requirements for an endorsement in that subject area or specialization.

(b) (~~Candidates who apply for a continuing certificate after August 31, 1992, shall have completed an approved masters degree.~~

(c)) Candidates for a continuing certificate shall have been granted at least two subject area endorsements.

((~~d~~)) (c) Candidates who apply for a continuing certificate after August 31, 1992, who have not successfully completed course work or an in-service program including a minimum of ten clock hours of instruction on issues of abuse, must complete such course work or in-service program as a condition for the issuance of a continuing certificate. The content of the course work or in-service program shall discuss the identification of physical, emotional, sexual, and substance abuse, information on the impact of abuse on the behavior and learning abilities of students, discussion of the responsibilities of a teacher to report abuse or provide assistance to students who are the victims of abuse, and methods for teaching students about abuse of all types and their prevention.

AMENDATORY SECTION (Amending WSR 90-22-002, filed 10/25/90 and 11/20/90, effective 11/25/90 and 12/21/90)

WAC 180-79-117 EXPERIENCE REQUIREMENT FOR CONTINUING CERTIFICATION—TEACHERS. In addition to the academic requirements specified in WAC 180-79-115, candidates for continuing teachers' certificates shall provide, as a condition for the issuance of a continuing certificate, documentation of one hundred eighty days or full time equivalent or more satisfactory teaching experience with an authorized employer—i.e., school district, state agency, college or university, private school, or private school system—and at least thirty days of such employment with the same employer. (~~The requirements set forth in this section shall expire August 31, 1992.~~)

AMENDATORY SECTION (Amending WSR 90-22-002, filed 10/25/90, effective 11/25/90)

WAC 180-79-122 EXPERIENCE REQUIREMENT FOR INITIAL ENDORSEMENT—PRINCIPALS. In addition to the academic requirements specified in WAC 180-79-120(2), candidates for initial administrator's certificate with a principal's endorsement, as a condition for the issuance of such endorsement, documentation of one hundred eighty days or full time equivalent or more teaching experience with an authorized employer—i.e., school district, state agency, college or university, private school, or private school system—and at least thirty days of such employment with the same employer. (~~The requirements set forth in this section shall expire August 31, 1992.~~)

AMENDATORY SECTION (Amending WSR 92-04-044, filed 1/31/92, effective 3/2/92)

WAC 180-79-123 EXPERIENCE REQUIREMENT FOR CONTINUING CERTIFICATION—ADMINISTRATORS. In addition to the academic requirements specified in WAC 180-79-120, candidates for continuing administrator certificates shall provide, as a condition for issuance of a continuing certificate, documentation of one hundred eighty days or full time equivalent or more employment in the respective role with an authorized employer—i.e., school district, educational service district, state agency, college or university, private school, or private school system—and at least thirty days of such employment with the same employer. (~~The requirements set forth in this section shall expire August 31, 1992.~~)

AMENDATORY SECTION (Amending WSR 90-22-002, filed 10/25/90, effective 11/25/90)

WAC 180-79-127 EXPERIENCE REQUIREMENT FOR CONTINUING CERTIFICATION—ESAS. In addition to the academic requirements specified in WAC 180-79-179, candidates for continuing educational staff associate certificates shall provide, as a condition for issuance of a continuing certificate, documentation of one hundred eighty days or full time equivalent or more employment in the respective role with an authorized employer—i.e., school district, educational service district, state agency, college or university, private school, or private school system—and at least thirty days of such employment with the same employer. (~~The requirements set forth in this section shall expire August 31, 1992.~~)

WSR 92-15-039  
PERMANENT RULES  
DEPARTMENT OF  
HEALTH AND SOCIAL SERVICES  
(Public Assistance)

[Order 3417—Filed July 9, 1992, 2:31 p.m.]

Date of Adoption: July 9, 1992.

Purpose: This rule amendment clarifies that a household that does not transact its FCA during the issuance's validity period shall lose its entitlement to the benefits.

Citation of Existing Rules Affected by this Order: Amending WAC 388-49-560 Issuances.

Statutory Authority for Adoption: RCW 74.04.050.

Pursuant to notice filed as WSR 92-12-041 on May 29, 1992.

Effective Date of Rule: Thirty-one days after filing.

July 9, 1992

Leslie F. James, Director  
Administrative Services  
by Rosemary Carr

to comment upon adoption of a permanent rule would be contrary to the public interest.

Reasons for this Finding: A limited number of halibut are available for harvest in Catch Area 3 and that portion of Catch Area 4 west of the Bonilla Tatoosh line for Friday openings.

Effective Date of Rule: Immediately.

July 8, 1992

Judith Merchant  
Deputy  
for Robert Turner  
Director

**AMENDATORY SECTION** (Amending Order 3022, filed 6/1/90, effective 7/2/90)

WAC 388-49-560 ISSUANCE. (1) The department shall issue food coupons through a:

(a) Food coupon authorization (FCA) system staggered through the tenth of the month((:)); or

(b) Direct coupon mail out system staggered through the tenth of the month.

(2) For FCAs issued after the twentieth of the month, the department shall issue a valid FCA:

(a) Until the end of the month and issue a valid replacement FCA if the household is unable to transact the FCA before the expiration date((:)); or

(b) For the current month's benefits valid in the following month.

(3) For eligible households applying on the sixteenth of the month or after, the department shall issue the prorated allotment for the initial month and the allotment for the first full month at the same time, except for households:

(a) ~~((Households))~~ Eligible for expedited services for which missing or postponed verification have not been provided; and

(b) ~~((Households))~~ Ineligible for the initial month, or the second month.

(4) The department shall not transact or restore an FCA with an expired validity date, except as specified under WAC 388-49-560(2).

(5) The department shall maintain issuance records for a period of three years from the month of origin.

**NEW SECTION**

WAC 220-56-25500P HALIBUT-SEASONS. Notwithstanding the provisions of WAC 220-56-255, effective immediately until further notice it is unlawful to take, fish for or possess halibut taken for personal use except as follows:

(1) Those waters of Catch Areas 1, and 2, are open May 1, 1992 seven days a week.

(2) Those waters of Catch Areas 3 and 4 west of the Bonilla Tatoosh Line are open on Fridays only.

(3) Those waters of Catch Area 4 east of the Bonilla Tatoosh Line and Catch Areas 5 through 13 are open May 9, 1992 seven days a week.

**REPEALER**

The following section of the Washington Administrative Code is repealed:

WAC 220-56-25500N HALIBUT-SEASONS. (92-42)

**WSR 92-15-041**

NOTICE OF PUBLIC MEETINGS  
WHATCOM COMMUNITY COLLEGE  
[Memorandum—July 6, 1992]

The board of trustees of Whatcom Community College, District Number Twenty-One, has cancelled its regularly scheduled meeting for July 14, 1992, at 2:00 p.m. in the Board Room of the Laidlaw Center.

**WSR 92-15-040**

EMERGENCY RULES  
DEPARTMENT OF FISHERIES  
[Order 92-43—Filed July 9, 1992, 3:59 p.m.]

Date of Adoption: July 8, 1992.

Purpose: Personal use rules.

Citation of Existing Rules Affected by this Order: Repealing WAC 220-56-25500N.

Statutory Authority for Adoption: RCW 75.08.080.

Pursuant to RCW 34.05.350 the agency for good cause finds that immediate adoption, amendment, or repeal of a rule is necessary for the preservation of the public health, safety, or general welfare, and that observing the time requirements of notice and opportunity

**WSR 92-15-042**

NOTICE OF PUBLIC MEETINGS  
CONSERVATION AND RENEWABLE  
ENERGY SYSTEM  
[Memorandum—July 7, 1992]

Regular meetings of the board of directors of CARES shall be held on the Thursday preceding the third Friday of each month at 10:00 a.m.

Regular meetings of the board shall be held at the Radisson Hotel-Seattle Airport, 17001 Pacific Highway South, Seattle, WA 98188, unless notice to the contrary as to the place is given to the members of the board and

to others in accordance with the rules as required by law for special meetings.

The managing director is authorized to execute on behalf of CARES a rental agreement for the use of the places identified above at the times identified above for the balance of calendar 1992 under such terms and conditions as are necessary and reasonable.

**WSR 92-15-043**  
**PERMANENT RULES**  
**DEPARTMENT OF**  
**HEALTH AND SOCIAL SERVICES**  
**(Public Assistance)**

[Order 3418—Filed July 9, 1992, 4:24 p.m.]

Date of Adoption: July 9, 1992.

Purpose: To correct typographical errors and delete sections related to family day care homes and day care centers, which are now in different chapters. The substance of these revisions were heard at public hearing December 27, 1991, and July 7, 1992.

Citation of Existing Rules Affected by this Order: Repealing WAC 388-73-420 Orientation and training—Family day care home, 388-73-422 Capacity—Family day care home, 388-73-423 Staffing—Family day care, 388-73-424 Family day care—Program and equipment, 388-73-426 Family day care—Fire safety, 388-73-428 Family day care—Health inspection, 388-73-450 Required personnel—Day care centers, 388-73-452 Program—Day care centers, 388-73-454 Toddlers and preschool children—Day care centers, 388-73-458 Furnishings and equipment—Day care centers and 388-73-460 Play areas—Day care centers; and amending chapter 388-73 WAC, Child care agencies—Minimum licensing certification requirements.

Statutory Authority for Adoption: RCW 74.15.030.

Pursuant to notice filed as WSR 92-12-009 on May 22, 1992.

Changes Other than Editing from Proposed to Adopted Version: Caption of chapter 388-73 WAC amended.

Effective Date of Rule: Thirty-one days after filing.

July 9, 1992

Leslie F. James, Director  
Administrative Services  
by Rosemary Carr

Chapter 388-73 WAC  
**CHILD CARE AGENCIES—((ADULT FAMILY  
HOMES)) MINIMUM LICENSING/CERTIFICA-  
TION REQUIREMENTS**

**AMENDATORY SECTION** (Amending Order 1933, filed 1/5/83)

WAC 388-73-01950 FIRE STANDARDS. All group care facilities, ~~((day care centers;))~~ mini-day care centers, and maternity centers shall conform to the rules and regulations adopted by the Washington state fire marshal's office establishing minimum standards for the prevention of fire and for the protection of life and

property against fire. The Washington state fire marshal's standards are found in chapter 212-55 WAC.

**AMENDATORY SECTION** (WSR 92-08-056, filed 3/26/92, effective 4/26/92)

WAC 388-73-060 WORK ASSIGNMENTS. Agencies shall not use persons under care to carry the responsibility for basic maintenance of the facility and equipment.

(1) Persons under ~~((call {care}))~~ care may perform household tasks insofar as appropriate to the program and as part of a planned learning experience.

(2) For a person under care, work assignments shall be appropriate to the age and physical condition of the person under care.

(3) For persons under care, work assignments other than household tasks which are part of the treatment plan may be performed insofar as appropriate to the age and physical condition of the person under care and adequate monetary compensation shall be provided.

**AMENDATORY SECTION** (Amending Order 2445, filed 12/2/86)

WAC 388-73-069 CONSUMPTION OF ALCOHOLIC BEVERAGES. Except for family foster homes, ~~((foster and day care;))~~ licensees and staff may not consume or have in their possession or on their person alcoholic beverages on the premises while children are in care. ~~((Persons providing direct care to children in family day care homes may not consume alcoholic beverages while providing care;))~~

**AMENDATORY SECTION** (WSR 92-08-056, filed 3/26/92, effective 4/26/92)

WAC 388-73-102 EQUIPMENT, SAFETY, AND MAINTENANCE. (1) In facilities operated by licensed agencies:

(a) The physical plant, premises, and equipment shall be maintained in a clean and sanitary condition, free of hazards, and in good repair;

(b) Steps shall be provided with handrails as determined necessary by the department. Emergency lighting devices, such as flashlights, in operational condition shall be available; and

(c) All flaking or deteriorating lead-based paint on exterior and interior surfaces and equipment and toys accessible to preschool-age children shall be refinished with lead-free paint or other nontoxic material.

(2) Except in foster family homes, the facility's toilet rooms, kitchens, and other rooms subject to moisture shall have washable, moisture impervious floors; except that in the facility's kitchens, washable short-pile carpeting that is kept clean and sanitary may be approved by the department.

(3) Except in foster family homes, facilities caring for preschool children shall equip child accessible outlets with ~~((non-removable))~~ nonremovable safety devices or covers preventing electrical injury.

(4) There shall be provision for staff members to gain rapid access to any bedroom, toilet room, shower room,

bathroom, or other room occupied by children should an emergency need arise.

**AMENDATORY SECTION** (WSR 92-08-056, filed 3/26/92, effective 4/26/92)

**WAC 388-73-108 BEDROOMS.** In full-time care facilities operated by licensed agencies:

- (1)(a) Hallways, kitchens, living rooms, dining rooms, and unfinished basements shall not be used as bedrooms;
  - (b) Every bedroom shall be an outside room permitting entrance of natural light;
  - (c) Separate sleeping quarters shall be furnished for each sex for children over six years of age;
  - (d) Multiple occupancy bedrooms shall provide not less than fifty square feet per occupant of floor area exclusive of closets;
  - (e) There shall be not less than thirty inches laterally between beds;
  - (f) In group-care facilities and maternity homes, single occupancy bedrooms shall provide at least eighty square feet of floor space;
  - (g) Each person in care shall have a bed of his or her own;
  - (h) There shall be no more than four persons to a bedroom except in facilities licensed for more prior to the adoption of these rules;
  - (i) For facilities licensed after December 31, 1986, sleeping rooms shall have a minimum ceiling height of 7.5 feet and shall have a window area, permitting the direct entrance of natural light, of not less than one-tenth of the required floor space.
- (2) For each person in care, there shall be a bed at least thirty inches wide with a clean, firm mattress, pillow, sheets, blankets, and pillowcases. Each person's pillow shall be covered with waterproof material or be of a washable type. The agency shall provide waterproof mattress covers for incontinent persons.
- (3) The agency shall not permit the upper bunk of double-deck beds for use by persons who may be endangered by the use of an upper bunk. When mother and infant sleep in the same room, the room shall contain at least eighty square feet of usable floor space. The agency shall provide an infant a crib or bassinet with a clean, firm mattress covered with a waterproof material. The agency shall allow only one mother and her newborn infant or infants to occupy a bedroom.
- (4) Bedding shall be clean; sheets and pillowcases shall be laundered weekly.
- (5) The agency shall not allow a child over one year of age (~~shall not~~) to share a bedroom with foster parents or agency staff. An adult shall be on the same floor or within easy hearing distance and accessibility to where children under six years of age are sleeping.
- (6) See WAC 388-73-146(7) for requirements for cribs used by infants in care.
- (7) The agency shall allow only rooms having unrestricted direct access to hallways, corridors, living rooms, day rooms, or such common use area for use as bedrooms for persons in care.

**AMENDATORY SECTION** (WSR 92-08-056, filed 3/26/92, effective 4/26/92)

**WAC 388-73-118 TOILETS, HANDWASHING SINKS, AND BATHING FACILITIES.** Licensees shall provide sanitary facilities and equipment according to the following configuration:

(1) There shall be at least one indoor flush-type toilet and one nearby handwashing sink with hot and cold or tempered running water. The following ratios of persons normally on the premises to facilities shall apply:

	Toilets	Handwashing Sinks	Bathing Facilities
Day Treatment Programs	*2 minimum and 1:15 or major fraction	2 minimum and 1:15 or major fraction	None Required
Mini-Day Care Programs	1 minimum	1 minimum	None Required
Group Care Facilities Maternity Homes	2 minimum and 1:8 or major fraction	2 minimum and 1:8 or major fraction	1 minimum and 1:8 or major fraction
Foster Family Home	1 minimum	1 minimum	1 minimum

\*A minimum of one is acceptable provided no more than fifteen persons capable of using a flush-type toilet are on the premises.

(2) The licensee shall assure that toilet facilities comply with the following standards:

- (a) Toilet and bathing facilities shall provide for privacy for persons of the opposite sex six years of age or older;
- (b) Toilet, urinals, and handwashing sinks shall be of appropriate height for the children served or be provided with a safe and easily cleanable platform impervious to moisture;
- (c) Except in foster family homes, handwashing and bathing facilities shall be provided with hot and cold or tempered running water not exceeding one hundred twenty degrees Fahrenheit or warm running water in the range of (~~eighty-five~~) eighty-five to one hundred twenty degrees Fahrenheit maximum;
- (d) All bathing facilities shall have a conveniently located grab bar unless other safety measures, such as nonskid pads, are approved by the department as described under subdivision (2)(g) of this subsection. Preschool children and severely and multiply-handicapped children shall not be left unattended in a bathtub or shower;
- (e) Equipment for toileting and toilet training of toddlers shall be provided, maintained in a sanitary condition and located on a moisture impervious surface at all times. Children less than eighteen months of age and/or using toilet training equipment need not be included when determining the number of flush-type toilets required;
- (f) Whenever urinals are provided, the number of urinals shall not replace more than one-third of the total required toilets;
- (g) In maternity homes, bathing facilities shall have adequate grab bars in convenient places. All sleeping areas shall have at least one toilet and handwashing sink on the same floor;

(h) Soap and individual towels or disposable towels or other approved hand drying devices shall be provided.

AMENDATORY SECTION (WSR 92-08-056, filed 3/26/92, effective 4/26/92)

WAC 388-73-210 FOSTER CARE LICENSEES.

(1) As a minimum, child-placing agencies shall utilize application and home study forms and procedures prescribed or approved by the department. See also WAC 388-73-024 and 388-73-302.

(2) A child-placing agency requesting licensure of a ~~((non-traditional))~~ nontraditional home, which may be of community concern, shall first submit the application, home study, and other documents to the department for review.

AMENDATORY SECTION (WSR 92-08-056, filed 3/26/92, effective 4/26/92)

WAC 388-73-212 FOSTER CARE PLACEMENTS. (1) The agency shall, in planning for children, give due consideration to:

(a) A child's basic right to his or her own home and family;

(b) The importance of skillful professional service to parents to help them meet the child's needs in his or her own home whenever possible;

(c) The child's individual needs, ethnic background, religious background, family situation, and the wishes and participation of the child's parent; and

(d) The selection of a foster home that will provide for maximum development of the child's capacities and meet the child's individual needs. See WAC 388-73-044 for recruitment involving placement of American Indian children. The agency shall notify the DCFS licensor before placement of a child into a ~~((non-traditional))~~ non-traditional home which may be of community concern.

(2) The agency shall use a written intake study for each child and expectant mother as the basis for acceptance for foster care and related services.

(3) Every acceptance for care by an agency shall be based on well-planned, individual preparation of the child and the child's family and the expectant mother other than in emergent situations.

(4) Except in an emergency, a child shall be placed in foster care only with the written consent of the child's parents or under order of a court of competent jurisdiction. Such consent or order shall include authorization for medical care or emergency surgery.

(5) All foster homes and group care facilities used by child-placing agencies shall be licensed prior to placing any children therein.

(6) An agency will give sufficient information about the child (especially behavioral and emotional problems) and the child's family to foster parents to enable them to make an informed decision regarding whether or not to accept a child in their home. The agency shall inform the foster parents that this information is confidential and may not be shared. The agency shall document the provision of this information in the child's file at the time of placement.

(7) The frequency of the caseworker's contacts with a foster child, the foster child's foster family, or with an expectant mother shall be determined by a casework plan reflecting their needs, but shall not be less frequent than one in-home visit every ninety days. Each foster child and one or both foster parents shall be seen at each visit.

(8) The agency in preparing a child for discharge from placement shall follow the same basic steps as preparation for placement, but a child shall be released only to parents, adoptive parents, guardians or other persons or agencies holding legal custody, or to a court of competent jurisdiction.

AMENDATORY SECTION (WSR 92-08-056, filed 3/26/92, effective 4/26/92)

WAC 388-73-216 ADOPTIVE PLACEMENTS.

(1)(a) The agency shall protect the child from unnecessary separation from the child's birth parents when the birth parents are capable of and willing to successfully fulfill their parental role or can be helped to do so.

(b) The agency's adoptive placement of a child shall be made only when the child is freed for adoption by action of a court of competent jurisdiction giving the agency authority to place such child for adoption and to consent to the child's adoption as provided by chapter 26.33 RCW.

(2)(a) The agency shall evaluate potential adoptive parents for a child in relation to the adoptive parents':

(i) Capacity and readiness for parenthood;

(ii) Emotional and physical health; and

(iii) Ability to meet the physical, social, emotional, educational, and cultural needs of the child.

(b) An agency placing a child for whom it feels that continued contact with the child's birth family is in the child's best interest shall evaluate the adoptive family's willingness to have the child maintain contact with members of the child's birth family;

(c) The agency shall file preplacement reports with the court as required by RCW 26.33.180 through 26.33.230.

(3) Child-placing agencies shall consider the racial, ethnic, and cultural heritage needs of the child being placed. At the same time, the agency shall prevent discrimination on the basis of race, color, or national origin against any of its clients.

(4) Agencies shall ensure that the child's best interest are met by requiring that a number of factors are taken into consideration when making adoptive placement decisions:

(a) When making a child adoptive placement decision, the agency shall emphasize the best interests of the child, taking into account the particular child, parents and circumstances. The agency shall take into consideration the following factors:

(i) Relationship of family to child;

(ii) Sibling placement status;

(iii) Physical and emotional needs of child;

(iv) Age;

(v) Sex;

(vi) Racial;

(vii) Ethnic and cultural identity;



- (viii) Placement background;
- (ix) Availability of placement resources for timely placement; and
- (x) Continuity and stability of the ~~((childs))~~ child's foster care placement and child's psychological attachment to foster family.

(b) The agency shall make all child adoptive placement decisions on a case-by-case basis to take into account the particular child, adoptive parents, and circumstances.

(c) Although a child's racial, ethnic, and cultural identity should be considered when making an adoptive placement decision, the agency may not make the decision based upon such factors unless it is in the best interest of the child to be placed, taking into account the particular child, parents, and circumstances. See WAC 388-73-044 for placement involving an American Indian child.

(5) The agency shall transmit to the adoptive parent or parents at time of the child's placement a report containing all available medical, social, and psychological information about the child and the child's birth parents. The agency's report shall not contain information which might identify the birth parents. The adoptive parent or parents shall sign one copy of the report, signifying receipt of the information. The agency shall retain this signed copy in the child's permanent record.

(6) The agency shall visit the adoptive home of all adoptive placements at least once in the first thirty days and an additional face-to-face visit each sixty days thereafter until the adoption is finalized. Upon filing of the petition for adoption, the agency shall make recommendation to the court on the advisability of finalizing the adoption.

(7) The agency shall be available for consultation with the adoptive family after finalization of the adoption.

(8) The agency shall maintain a permanent sealed record of each person for whom it has accepted permanent custody. This record shall contain all available identifying legal, medical, and social information. Access to the identifying information shall not be given without a court order if the person has been adopted. In the event the agency closes, the agency shall make arrangements for the permanent retention of these records and will inform the division of children and family services adoption program manager.

AMENDATORY SECTION (Amending Order 1336, filed 9/8/78)

WAC 388-73-400 DAY CARE PROVIDERS. The rules in WAC 388-73-400 through 388-73-490 apply exclusively to licensing of ~~((family day care homes,))~~ mini-day care programs ~~((and day care centers))~~.

AMENDATORY SECTION (WSR 92-08-056, filed 3/26/92, effective 4/26/92)

WAC 388-73-901 MULTIDISCIPLINARY CARE PLAN FOR SEVERELY AND MULTIPLY-HANDICAPPED CHILDREN. (1) For each severely and multiply-handicapped child, the licensee shall have

a multidisciplinary plan of care addressing the social service, medical, nutritional, rehabilitative, and educational needs of each child.

(2) The licensee's care plan shall indicate:

(a) Care to be given and goals to be accomplished; and

(b) Which professional service is responsible for each element of care.

~~((to be accomplished and which professional service is responsible for each element of care.))~~

(3) The licensee's care plan shall be reviewed, evaluated, and updated as necessary by all professional personnel involved in the care of the child.

(4) Professional personnel shall meet at least annually to re-evaluate each child's current condition, progress, prognosis, and need for ongoing care and additional services.

(5) The licensee or staff shall record quarterly progress reports in the child's record.

REPEALER

The following sections of the Washington Administrative Code are repealed:

WAC 388-73-420 Orientation and training—Family day care home.

WAC 388-73-422 Capacity—Family day care home.

WAC 388-73-423 Staffing—Family day care.

WAC 388-73-424 Family day care—Program and equipment.

WAC 388-73-426 Family day care—Fire safety.

WAC 388-73-428 Family day care—Health inspection.

WAC 388-73-450 Required personnel—Day care centers.

WAC 388-73-452 Program—Day care centers.

WAC 388-73-454 Toddlers and preschool children—Day care centers.

WAC 388-73-458 Furnishings and equipment—Day care centers.

WAC 388-73-460 Play areas—Day care centers.

**WSR 92-15-044**

**PREPROPOSAL COMMENTS  
DEPARTMENT OF REVENUE**

[Filed July 9, 1992, 4:26 p.m.]

Subject of Possible Rule Making: WAC 458-20-17901 Public utility tax—Energy conservation and co-generation deductions.

Persons may comment on this subject in writing or by attending the public meeting. Written comments should be addressed to: Les Jaster, Rules Coordinator, Department of Revenue, P.O. Box 47458, Olympia, WA 98504-7458. Public meeting scheduled at: Evergreen Plaza Building, 2nd Floor Conference Room, 711 Capitol Way South, Olympia, WA, on August 26, 1992, at 10:00 a.m. (Written comments will be accepted to this date.)



Other Information or Comments by Agency at this Time, if any: This rule will discuss the energy conservation deductions relating to RCW 82.16.052. Most of these deductions previously related to RCW 82.16.055. A copy of the proposed rule draft and/or small business economic impact statement is available upon request. Contact Roseanna Hodson, (206) 586-4281.

July 9, 1992  
Les Jaster  
Rules Coordinator

**WSR 92-15-045**  
**PREPROPOSAL COMMENTS**  
**DEPARTMENT OF REVENUE**  
[Filed July 9, 1992, 4:28 p.m.]

Subject of Possible Rule Making: WAC 458-20-230 Statutory limitations on assessments.

Persons may comment on this subject in writing or by attending the public meeting. Written comments should be addressed to: Les Jaster, Rules Coordinator, Department of Revenue, P.O. Box 47458, Olympia, WA 98504-7458. Public meeting scheduled at: Evergreen Plaza Building, 2nd Floor Conference Room, 711 Capitol Way South, Olympia, WA, on August 26, 1992, at 10:00 a.m. (Written comments will be accepted to this date.)

Other Information or Comments by Agency at this Time, if any: This rule will explain Department of Revenue's policy for statute of limitations related to unregistered taxpayers. It will also indicate conditions under which a taxpayer can request a statute of limitations waiver be signed and explains that the waiver extends period open for refunds. A copy of the proposed rule draft and/or small business economic impact statement is available upon request. Contact Roseanna Hodson, (206) 586-4281.

July 9, 1992  
Les Jaster  
Rules Coordinator

**WSR 92-15-046**  
**PERMANENT RULES**  
**DEPARTMENT OF AGRICULTURE**  
[Filed July 10, 1992, 9:21 a.m.]

Date of Adoption: July 10, 1992.

Purpose: To update the current fee schedule to reflect the changes to standards and instructions established by the federal grain inspection service, USDA.

Citation of Existing Rules Affected by this Order: Amending chapter 16-212 WAC.

Statutory Authority for Adoption: Chapter 22.09 RCW.

Pursuant to notice filed as WSR 92-11-073 on May 20, 1992.

Effective Date of Rule: Thirty-one days after filing.  
July 10, 1992  
Michael V. Schwisow  
Deputy Director  
for C. Alan Pettibone  
Director

**AMENDATORY SECTION** (Amending Order 1751, filed 12/2/81)

WAC 16-212-020 GRAIN AND COMMODITY INSPECTION POINTS. The following cities in the state of Washington are hereby designated as inspection points for the purpose of inspecting and weighing standardized grains, ((hay;)) beans, peas, lentils and other commodities: Colfax, Kalama, ((Longview;)) Pasco, Seattle, Spokane, Tacoma and Vancouver.

**AMENDATORY SECTION** (Amending Order 1913, filed 12/12/86)

WAC 16-212-060 OFFICIAL INSPECTION AND/OR WEIGHING FEES UNDER THE UNITED STATES GRAIN STANDARDS ACT.

- (1) Combination inspection and weighing fees. Ships, barges, unit trains and transfers of bulk grain.
  - (a) From vessel to elevator, per ton . . . . . \$ 0.12
  - (b) Bin transfers, per ton . . . . . \$ 0.12
  - (c) From elevator to vessel, per ton . . . . . \$ 0.12
  - (d) From railcars of a unit train, sampled by diverter samplers, batch weighed and inspected under the subplot inspection plan in units of not less than five cars, per ton . . . . . \$ 0.12
- (2) Inspection only of railroad boxcars, open hopper-type cars or covered hopper-type cars, original inspection.
  - (a) When sampled by United States Department of Agriculture approved mechanical belt, spout or leg ((type)) samplers ((at plants)), per car (batch grades-up to a maximum of 5 car units are charged at the per car rate) . . . . . \$ 14.50
  - (b) When sampled by United States Department of Agriculture approved grain trier, original and subsequent original inspections, per car . . . . . \$ 23.00
  - (3) Inspection only of trucks, per truck . . . . . \$ 14.00
  - (4) Reinspections of railroad boxcars, open hopper-type cars, covered hopper-type cars, ship subplot samples, barge lots, truck lots, and submitted samples.
    - (a) When based on an official file sample, per reinspection . . . . . \$ 8.50
    - (b) When based on a new sample, for railcars only, per reinspection . . . . . \$ 23.00
    - (c) When based on a new sample, for trucks only, per reinspection . . . . . \$ 14.00
    - (5) Submitted samples,
      - (a) Standardized grains, except canola per inspection . . . . . \$ 7.00
      - (b) Canola, per inspection . . . . . \$ 13.00
      - (6) Fees for laboratory determination of erucic acid, and/or glucosinolate, and/or oil

content of canola, identical to the fees assessed by the Federal Grain Inspection Service.

- (7) Factor analysis and/or certification.
  - (a) Factors added to existing certificates, or requested on ship subplot analyses, that do not affect the grade: per factor . . . . . \$ 2.50
  - PROVIDED, That on submitted sample certificates of grade for wheat and barley, dockage to the nearest one-tenth percent will be shown in remarks section and, for wheat, foreign material shown on the factor line, when it is not a grading factor, without additional charge.
  - (b) Factor certification only (maximum of two factors), per certificate . . . . . \$ 3.00
    - (i) Additional factors added to a factor certificate, per factor . . . . . \$ 2.50 (A maximum of ~~\$(6.25)~~ 7.00 will be charged for grading factors only.)
    - (ii) When submitted samples are not of sufficient size to provide official grade analysis, obtainable factors will be provided, upon request of the applicant, at the factor only rate.
- ~~((7))~~ (8) Official (NIRR or NIRT) protein analysis.
  - (a) Protein and/or oil analysis in conjunction with official inspection for grade . . . . . \$ 6.25
  - (b) Protein and/or oil only (~~(-submitted sample or reinspection)~~) . . . . . \$ 8.50
  - When based on official sample (including new sample reinspection) add the applicable sampling charges.
  - (c) Protein (~~(based on official)~~) and/or oil only: Submitted sample (~~(-add applicable sampling charges.)~~) or reinspection based on official file sample . . . . . \$ 8.50
- ~~((8))~~ (9) Inspection of sacked grain at inspection points, per cwt . . . . . \$ 0.06
- ~~((9))~~ (10) Checkloading sacked grain, per man-hour . . . . . \$ 23.00
- ~~((10))~~ (11) Waxy corn determination, on request, per determination . . . . . \$ 12.00
- ~~((11))~~ (12) Aflatoxin testing fees
  - (a) Screening or quantitative testing determinations, based on official sample, except thin layer chromatography, per test . . . . . \$ 35.00
  - (b) Submitted samples, screening or quantitative determinations, except thin layer chromatography, per test . . . . . \$ 23.00
  - (c) Reinspection, based on official file, screening or quantitative, except thin layer chromatography, per test . . . . . \$ 23.00
  - (d) Reinspection, based on a new sample, screening or quantitative, except thin layer chromatography, per test . . . . . \$ 35.00
  - (e) Thin layer chromatography determinations will be assessed at a rate identical with the fees charged by the Federal Grain Inspection Service.
- (13) Stowage examinations – ships, barges or vessels.
  - (a) Per stowage space and/or tank, per examination . . . . . \$ 22.50
  - (b) Initial inspection, minimum charge . . . . . ~~\$(12.00)~~ 112.50

- (c) Subsequent inspections, minimum charge . . . . . \$ 67.50
- (d) Stowage examinations will be made on ships or vessels at anchor in midstream when requested.
  - (i) It is the responsibility of the applicant to provide safe transportation by licensed tug or water taxi to and from the vessel.
  - (ii) A minimum of two hours of regular time at \$23.00 per hour (one inspector) for general cargo vessels and a minimum of four hours of regular time at \$23.00 per hour (two inspectors) shall be charged for tankers in addition to the established inspection fee.
  - (iii) Inspections can only be made at the convenience of the grain inspection office, during daylight hours, under safe working conditions, when weather conditions permit.
  - (iv) Inspections can only be made within the area of the designated tidewater grain inspection office.
  - (v) A ship's or vessel's officer or company agent shall accompany the licensed shiphold inspector(s).
  - (e) A minimum of four hours per inspector at the applicable overtime rate shall also be assessed on Saturdays, Sundays, or holidays.
- ~~((12))~~ (14) Other stowage examinations.
  - (a) Sea van-type containers (when checkloading is not required) . . . . . \$ 7.60
  - (b) Railroad cars, trucks and other containers, not in conjunction with loading, per container . . . . . \$ 7.60
  - ~~((13))~~ (15) Checktesting of diverter and mechanical samplers, per man-hour . . . . . \$ 23.00
  - ~~((14))~~ (16) Ship samples.
    - (a) Ship composite samples.
      - (i) Initial set of samples to applicant (maximum of three samples) . . . . . no charge
      - (ii) Additional samples or samples at the request of other interested parties, per sample (two sample minimum when not requested with initial set) . . . . . \$ 5.00
    - (b) Ship samples on a subplot basis, per sample . . . . . \$ 5.00
  - ~~((15))~~ (17) Weighing services.
    - (a) Class X weighing services.
      - (i) From railroad boxcars, open or covered hopper-type cars (without inspection required) or vessels to elevator (grain only), per ton . . . . . \$ 0.10
      - (ii) From elevator to boxcars, open or covered hopper-type cars, barges (without inspection required) or vessels (without inspection, grain only), per ton . . . . . \$ 0.10
      - (iii) Bin transfers (grain only), per ton . . . . . \$ 0.10
      - (iv) Trucks, per truck or weight lot . . . . . \$ 7.00
    - (b) Class Y weighing services, per man-hour . . . . . \$ 23.00
    - (c) Checkweighing of sacked grain, per man-hour . . . . . \$ 23.00
    - (d) Scale certification/checktesting of official weighing scales.
      - (i) Weights and measures scale specialist, per man-hour . . . . . \$ 31.50

(ii) Grain inspection personnel, per man-hour ..... \$ 23.00

**AMENDATORY SECTION** (Amending Order 1913, filed 12/12/86)

**WAC 16-212-070 OFFICIAL SERVICES UNDER THE AGRICULTURAL MARKETING ACT OF 1946.**

- (1) ~~((Hay inspection: (a) Complete inspection (minimum charge \$30.00), per ton ..... \$ 1.00 (b) Factor inspection (minimum charge \$20.00), per ton ..... \$ 1.00 (c) Submitted sample inspection, per sample ..... \$ 5.00~~
  - ~~((2)))~~ (2)) Inspection ~~((of beans, dry peas, lentils, and similar))~~ or analysis of graded and nongraded commodities.
    - (a) Inspection of bagged commodities at inspection points, per cwt ..... \$ 0.06
    - (b) Bulk commodity inspection at inspection points, per ton ..... \$ 0.28
    - (c) Minimum charge for bulk or bagged commodities (one hour) ..... \$ 23.00
    - (d) Submitted sample inspection, per sample ..... \$ 13.00
  - ~~((3)))~~ (2) Weighing and combination inspection/weighing services for bulk commodities.
    - (a) Weighing only, other than grain, per ton ..... \$ 0.11
    - (b) Combination inspection/weighing of bulk commodities under federal grade standards, state standards, or for factor determinations, per ton ..... \$ 0.12
    - (c) Weigh grain by-products into portable containers including fitness examination of the container, weigh and sample the by-product (thirty ton maximum) ..... \$ 14.00
  - ~~((4)))~~ (3) Factor analysis.
    - (a) Moisture only ..... \$ 5.00
    - (b) Additional factors, the determination of which are not required to establish grade, or otherwise not required by regulation, added to an existing certificate, per factor .... \$ 2.50
    - (c) Certification, factor only (maximum two factors), per certificate ..... \$ 3.00
    - (d) Additional factors added to a factor certificate, per factor ..... \$ 2.50 (A maximum of \$13.00 will be charged for grading factors only.)
    - (e) Analysis of rapeseed for official factors, per certificate ..... \$ 13.00
    - (f) If official inspection is required for rapeseed, the applicable sampling only fee shall be assessed in addition to the factor analysis fee.
  - ~~((5)))~~ (4) Sampling only, bulk commodities.
    - (a) Trucks or containers, per carrier ..... \$ 14.00
    - (b) Boxcars, open or covered hopper-type cars, per car ..... \$ 23.00

~~((6)))~~ (5) Processed commodity and defense personnel support center (DPSC) inspection fees.

- (a) Per man-hour, two hour minimum, rate per hour ..... \$ 23.00
- (b) In addition to the charges, if any, for sampling and other requested service, a fee will be assessed for each laboratory analysis or test identical with the amount charged by the federal grain inspection service for laboratory tests performed under authority of the Agricultural Marketing Act and for any postage or other costs of mailing not included in these fees.

~~((7)))~~ (6) Sanitation inspections.

- (a) Initial inspection ..... no charge
- (b) Reinspections, four hour minimum, per man-hour ..... \$ 23.00

~~((8)))~~ (7) Stowage examinations under the Agricultural Marketing Act shall be subject to the rates, restrictions, and conditions cited in WAC 16-212-060 (13) and (14).

- ~~((a) Ships and vessels: (i) Initial inspection, basic fee ..... \$150.00 (ii) Subsequent inspections, basic fee ..... \$100.00 (iii) In addition to the basic fee, there shall be levied a fee of \$23.00 per hour, per inspector.~~

~~(iv) These inspections shall be subject to the same restrictions and conditions as ship stowage examinations under the United States Grain Standards Act, as per WAC 16-212-060 (11)(d)(i) through (iv).~~

~~(b) Other stowage examinations shall be at the rate prescribed for containers listed in WAC 16-212-060(12).~~

~~(9) Aflatoxin))~~ (8) Mycotoxin testing fees.

~~((Black light and/or minicolumn)) Screening or quantitative testing determinations, except thin layer chromatography per ((hour, per inspector)) test ..... \$ ((23.00)) 35.00~~

~~(b) ((Minicolumn determination, per test .. \$ 15.60~~

~~(c)) Thin layer chromatography ((fees and/or minicolumn fees, if applicable,)) determinations will be assessed ((for laboratory analyses)) at a rate identical with the ((amount)) fees charged by the Federal Grain Inspection Service ((for that test)).~~

~~((10)))~~ (9) Falling numbers determinations, per determination ..... \$ 12.00

Liquefaction number, per determination .... \$ 0.50

**AMENDATORY SECTION** (Amending Order 1836, filed 7/2/84)

**WAC 16-212-080 MISCELLANEOUS FEES.**

(1) Mailing of samples shall be charged at actual mailing costs, minimum charge ..... \$2.00

(2) Fee for pickup of samples on routes established by the department, per sample ..... \$0.60

(3) Fees for services performed at places other than established grain and commodity inspection points.

(a) Travel time, per employee, will be charged at the applicable straight time or overtime rate from office to inspection point and return.

(b) Car mileage will be charged at the current published department of general administration rates (WAC

82-28-080), except where suitable transportation is provided by the applicant.

(c) If the travel is of sufficient duration to require payment of subsistence or per diem to the employee, an amount equal to the established subsistence and/or per diem rate (WAC 82-28-040 and 82-28-050) shall be assessed, except where applicable subsistence and lodging are furnished, or paid, by the applicant.

(d) Incidental costs of telephone, mailing, etc. shall be at actual cost.

(e) Facsimile transmissions, per page . . . . . \$1.00

(4) Certificate charges for certificates under the United States Grain Standards Act or the Agricultural Marketing Act of 1946.

(a) Divided original certificates, per certificate . \$1.50

(b) Extra copies of inspection, protein, weight, falling number, commodity or aflatoxin certificates, per copy . . . . . \$3.00

(5) Phytosanitary certification

(a) When performed in conjunction with official inspection, per certificate . . . . . \$6.50

(b) When performed without official inspection, add sampling fee, per hour . . . . . \$23.00

(6) Timely payment. Payment of fees and charges is due within thirty days after the date of the statement.

(a) If payment is not received within thirty days, service may be withheld until the delinquent account is paid; or

(b) In the case of such delinquent accounts, cash payment for subsequent service may be required; and

(c) A penalty of twelve percent per annum shall be assessed on the delinquent account balance.

AMENDATORY SECTION (Amending Order 1913, filed 12/12/86)

WAC 16-212-082 FEES FOR SERVICES PERFORMED UNDER STATE REGULATION. (1) Inspection of cultivated buckwheat and safflower under Washington state standards shall be at the rate applicable for the same type of sample under the fees for services under the United States Grain Standards Act.

(2) Cracked corn, corn screenings, and mixed grain screenings shall be inspected and/or weighed under the tonnage rate applicable for standardized grains as per WAC 16-212-060.

(3) Unofficial (NIRR or NIRT) protein analysis ((barley, mixed grain, etc.)), per ((determination)) unit . . . . . \$ 6.25

(4) ((Set of ten protein reference samples (one class) standardized with the state monitoring machine, per set . . . . . \$ 25.00

(5)) Rapeseed (except canola) inspection under state standards.

(a) Submitted sample for factors or grade, per sample . . . . . \$ 13.00

(b) When sampled by official personnel, add applicable sampling only fee.

(c) Export inspection and weighing in bulk, per ton . . . . . \$ 0.12

(d) Inspection of bagged rapeseed, per cwt . . . . . \$ 0.06

(e) Fees for laboratory determination of ureic acid((;)) and/or glucosinolate ((ter- et)) and/or oil content((, per set of tests . . . . \$ 50.00)) will be identical to the fees assessed by the Federal Grain Inspection Service.

Note: This fee is applied in addition to the inspection fee for grading under state standards.

(5) For other laboratory analysis not identified herein, a fee will be assessed for each test or analysis identical with the amount charged by USDA or Washington state agency laboratories.

**WSR 92-15-047**  
**PERMANENT RULES**  
**DEPARTMENT OF**  
**COMMUNITY DEVELOPMENT**  
[Order 92-05—Filed July 10, 1992, 11:00 a.m.]

Date of Adoption: July 1, 1992.

Purpose: To establish guidelines and procedures for state agencies and institutions to contract with cities and towns for the costs of providing fire protection services to state facilities and personnel.

Citation of Existing Rules Affected by this Order: Repealing WAC 365-80-010 through 356-80-090; and adding new sections 365-80-100 through 365-80-200.

Statutory Authority for Adoption: Chapter 35.21 RCW.

Pursuant to notice filed as WSR 92-09-146 on April 22, 1992.

Effective Date of Rule: Thirty-one days after filing.

July 9, 1992

Barbara Gooding  
Director

NEW SECTION

WAC 365-80-100 AUTHORITY. This chapter is promulgated pursuant to the authority granted in chapter 35.21 RCW.

NEW SECTION

WAC 365-80-110 PURPOSE. The purpose of these rules is to implement the provisions of Substitute House Bill No. 2937 (chapter 117, Laws of 1992) which provides that state agencies and municipalities may negotiate fire protection contracts at their discretion, and also provides that certain municipalities are eligible to enter into compulsory fire protection contracts with state agencies. These rules set forth the guidelines that the department will use in determining which municipalities are eligible to enter into compulsory fire protection contracts with state agencies, and a process for resolving disputes between the parties negotiating any such contracts.

NEW SECTION

WAC 365-80-120 DEFINITIONS. (1) "Department" means the department of community development.

(2) "Director" means the director of the department of community development.

(3) "Fire protection services" mean those fire services normally provided by a city or town for the protection of persons and property, except equipment operated and facilities owned by a city or town.

(4) "State facilities" mean buildings or facilities owned by the state or an agency or institution of the state, except those leased to a nontax-exempt person or organization, located within a city's or town's territorial limits.

(5) "State agency" means any agency or institution of the state of Washington.

(6) "Compulsory fire protection contract" means a fire protection contract as described in WAC 365-80-130.

(7) "Municipality" means city or town.

#### NEW SECTION

WAC 365-80-130 ELIGIBLE MUNICIPALITIES. Section 4, chapter 117, Laws of 1992, provides that when a municipality has one or more state agencies located within its city limits, the municipality and the agency or agencies may enter into fire protection contracts. Section 6, chapter 117, Laws of 1992, provides that in cities or towns where the estimated value of state facilities, as determined by the department, equals ten percent or more of the municipality's total assessed valuation, the state agency shall enter into a compulsory fire protection contract to provide the municipality with an equitable share of its fire protection services costs. An exception is provided where fire protection services are performed by state staff and equipment or by a fire protection district pursuant to RCW 52.30.020.

#### NEW SECTION

WAC 365-80-140 NOTIFICATION OF INTENT TO CONTRACT. Cities and towns shall notify the department and the appropriate state agency in writing, not later than July 1 of the fiscal year for which payment shall be made, of their intent to enter into compulsory fire protection contract negotiations. When more than one state agency is located in a city or town, that municipality may notify only the department of its intent to enter into compulsory fire contract negotiations, and the department shall thereupon notify the appropriate state agencies of the municipality's intent. Municipalities making such notification shall include the name of the state agency or agencies which have state-owned facilities located therein. The department shall verify whether the state agency facilities in the municipality meet the estimated value threshold.

#### NEW SECTION

WAC 365-80-150 METHOD FOR DETERMINING STATE AGENCY SQUARE FOOTAGE. After a municipality notifies the department of its intent to enter into compulsory fire protection contract negotiations (WAC 365-80-140), the department shall request a written report from each state agency in that municipality identifying the agency's state-owned facilities located therein. The report shall provide the square footage for

each agency, and shall be submitted to the department within twenty days after receiving the request. The square footage shall be calculated as of July 1 of the fiscal year for which payment shall be made. No adjustments will be made until the following year for new facilities built or acquired after the determinations have been made.

#### NEW SECTION

WAC 365-80-160 METHOD FOR DETERMINING ESTIMATED VALUES. The department shall estimate the value of a state facility by formula, using the facility's total square footage and an estimated value per square foot, as developed by the department in consultation with the department of general administration and the association of Washington cities. State facility values so assigned shall be used solely for the purpose of determining a municipality's eligibility to enter into compulsory fire protection contract negotiations, and shall be reviewed annually and revised accordingly.

#### NEW SECTION

WAC 365-80-170 NOTIFICATION TO MUNICIPALITIES. Not later than July 31 of each year the department shall inform in writing each municipality making notification under WAC 365-80-140, and the appropriate state agency or agencies, whether or not the municipality meets the estimated value threshold.

#### NEW SECTION

WAC 365-80-180 GOOD FAITH NEGOTIATIONS. Negotiations for compulsory fire protection contracts shall be conducted in good faith. Good faith negotiations may include consideration of the unique benefits and burdens associated with the presence of the state facility or facilities in the city or town.

#### NEW SECTION

WAC 365-80-190 DISPUTE RESOLUTION. If disputes arise when negotiating compulsory fire protection contracts, they shall be disposed of as follows:

(1) When notified by one of the parties of a disagreement, the director shall mediate a resolution.

(2) If the impasse continues, the director shall recommend a resolution. Mediation efforts shall be completed within thirty days after the director is notified.

(3) If the recommended resolution is not accepted, the director shall direct the parties to arbitration. Arbitration shall be conducted by a neutral arbiter acceptable to each party to the negotiations, and shall be completed within sixty days after being initiated. The arbiter shall select the final offer of either of the contracting parties, or the director's recommended resolution. Expenses associated with the arbitration shall be borne by the contracting parties, and the arbiter's decision shall be final, binding, and nonappealable.

#### NEW SECTION

WAC 365-80-200 ANNUAL PAYMENTS. Payment for compulsory fire protection contracts shall be

made directly to the municipalities not later than November 30 of each year. In cases involving arbitration, payment shall be made to the municipalities within thirty days of the arbiter's decision.

**REPEALER**

The following sections of the Washington Administrative Code are repealed:

- WAC 365-80-010 GENERAL PURPOSE.
- WAC 365-80-020 ELIGIBLE AGENCIES.
- WAC 365-80-030 STATE FACILITIES.
- WAC 365-80-040 FIRE PROTECTION SERVICES.
- WAC 365-80-050 BASIC FIRE PROTECTION PAYMENT.
- WAC 365-80-060 METHOD OF DETERMINING SQUARE FOOTAGE OF STATE FACILITIES.
- WAC 365-80-070 PAYMENTS.
- WAC 365-80-080 DECISIONS OF THE PLANNING AND COMMUNITY AFFAIRS AGENCY FINAL.
- WAC 365-80-090 UNEXPENDED FUNDS.

**WSR 92-15-048**  
**PERMANENT RULES**  
**DEPARTMENT OF HEALTH**  
 [Order 287—Filed July 10, 1992, 11:22 a.m.]

Date of Adoption: July 8, 1992.

Purpose: To amend the fee structure for residential treatment facilities for psychiatrically impaired children and youth and adult residential rehabilitation centers.

Citation of Existing Rules Affected by this Order: Amending WAC 246-323-990 and 246-325-990.

Statutory Authority for Adoption: RCW 43.70.250.

Pursuant to notice filed as WSR 92-10-014 on April 24, 1992.

Effective Date of Rule: Thirty-one days after filing.

July 8, 1992

Kristine M. Gebbie  
Secretary

**AMENDATORY SECTION** (Amending Order 122, filed 12/27/90, effective 1/31/91)

WAC 246-323-990 FEES. Residential treatment facilities for psychiatrically impaired children and youth (RTF-CY) licensed under chapter 71.12 RCW shall:

(1) Submit an annual fee of (~~thirty-five~~) forty-five dollars for each bed space within the licensed bed capacity of the RTF-CY;

(2) Include all bed spaces and rooms complying with physical plant and movable equipment requirements of this chapter; and

(3) Set up twenty-four-hour assigned patient beds only within the licensed bed capacity approved by the department.

**WSR 92-15-049**  
**NOTICE OF PUBLIC MEETINGS**  
**DEPARTMENT OF AGRICULTURE**  
**(Beef Commission)**  
 [Memorandum—July 9, 1992]

The Washington State Beef Commission will hold its August 28, 1992, board meeting in Pullman, Washington. It was earlier announced to be held in Seattle, Washington.

**WSR 92-15-050**  
**EMERGENCY RULES**  
**MARITIME COMMISSION**  
 [Filed July 10, 1992, 1:30 p.m.]

Date of Adoption: July 2, 1992.

Purpose: To provide an assessment schedule and commission coverage for passenger ferry boats engaged in international service between Washington and British Columbia.

Citation of Existing Rules Affected by this Order: Amending WAC 318-04-020 and 318-04-030.

Statutory Authority for Adoption: RCW 88.44.100.

Other Authority: RCW 34.05.350(1).

Pursuant to RCW 34.05.350 the agency for good cause finds that immediate adoption, amendment, or repeal of a rule is necessary for the preservation of the public health, safety, or general welfare, and that observing the time requirements of notice and opportunity to comment upon adoption of a permanent rule would be contrary to the public interest.

Reasons for this Finding: To create a new category for covered vessels thereby preventing existing passenger vessels, engaged in daily service by ferry from Washington to British Columbia, from withdrawing from commission coverage and thereby operating without an oil spill contingency plan and readiness testing response drills until the July 1, 1993, state filing deadline.

Effective Date of Rule: Immediately on filing.

July 7, 1992

Richard W. Buchanan  
Rules Coordinator

**AMENDATORY SECTION** (Amending Order WSR 91-19-073, filed 9/17/91)

WAC 318-04-020 DEFINITIONS Unless the context clearly requires otherwise, the definitions in this section apply throughout these rules.

"Tanker Barge" is a vessel as defined by R.C.W. 88.44.010(15) which is not self-propelled and is designed, constructed or adapted primarily to carry, or carries oil, as defined by R.C.W. 88.44.010(6), in bulk as cargo or cargo residue.

"Tanker Vessel" - is a vessel as defined by R.C.W. 88.44.010(15) which is self-propelled and designed, constructed or adapted primarily to carry or carries oil, as defined by R.C.W. 88.44.010(6), in bulk as cargo or cargo residue.

"Small Tanker Vessel" - is a vessel as defined by R.C.W. 88.44.010(15), of 300 gross registered tons or less, whether self-propelled or not, and designed, constructed or adapted primarily to carry or carries oil, as defined by R.C.W. 88.44.010(6), in bulk as cargo or cargo residue, which voluntarily pays assessments under WAC 318-04-030 and submits to the provisions of R.C.W. Chapter 88.44.

"Dry Cargo Barge" is a vessel as defined by R.C.W. 88.44.010(15) which is not self-propelled, but because it is not designed, constructed or adapted primarily to carry oil, is not a tanker barge. To be subject to assessment, the dry cargo barge must be carrying oil solely to fuel barge machinery or mobile equipment carried as cargo.

"Non-tanker Vessel" is a vessel as defined by R.C.W. 88.44.010(15) which is neither a tanker barge, a tanker vessel, nor a dry cargo barge.

"Maximum Capacity" is the volume of oil, as defined by R.C.W. 88.44.010(6) that a tanker barge or tanker vessel is capable of carrying when fully loaded as designed, constructed or adapted.

"Passenger Vessel" is a self-propelled ship of three-hundred or more gross tons with a fuel capacity of at least six-thousand gallons carrying passengers for compensation.

Reviser's note: RCW 34.05.395 requires the use of underlining and deletion marks to indicate amendments to existing rules. The rule published above varies from its predecessor in certain respects not indicated by the use of these markings.

**[AMENDATORY SECTION (Amending 91-19-073, filed 9/17/91, effective 11/5/91)]**

WAC 318-04-030 ASSESSMENTS Effective September 12, 1991 or upon approval by the Office of Marine Safety, whichever is later (except as provided below in this subsection), there is hereby levied by the Washington State Maritime Commission upon all non-exempt vessels, as defined by R.C.W. 88.44.010(15) and WAC 318-04-020, which transit upon the waters of this state and upon small tanker vessels, or the owners or operators thereof, an assessment in the following amounts:

**(A) On Tanker Barges whose maximum capacity is:**

	<u>Rate</u>
(1) 0 to 28,999 bbls	\$ 68.00
(2) 29,000 to 44,999 bbls	\$ 78.00
(3) 45,000 to 59,999 bbls	\$ 97.00
(4) 60,000 to 79,999 bbls	\$ 122.00
(5) 80,000 and over	\$ 152.00

**(B) On Tanker Vessels Carrying Oil as Cargo**

	<u>Rate</u>
(1) 0 to 300 Gross Registered Tons - On Small Tanker Vessels	\$ 25.00
(2) 301 to 9,999 Gross Reg. Tons	\$ 1,620
(3) 10,000 Gross Reg. Tons and Over	\$ 3,240

**(C) On Tanker Vessels When Not Carrying Oil as Cargo, but While Carrying Other Liquid or Semi-liquid Cargoes**

	<u>Rate</u>
(1) 301 - 500 Gross Reg. Tons	\$ 73.00
(2) 501 - 1,000 Gross Reg. Tons	\$ 97.00
(3) 1,001 - 4,999 Gross Reg. Tons	\$ 122.00
(4) 5,000 Gross Reg. Tons and over	\$ 162.00

**(D) On Dry Cargo Barges (not Tanker Barges)**

<u>Rate</u>
\$ 73.00

**(E) On Non-tanker Vessels Carrying Oil as Fuel for Propulsion Machinery**

	<u>Rate</u>
(1) 301 - 500 Gross Reg. Tons	\$ 73.00
(2) 501 - 1,000 Gross Reg. Tons	\$ 97.00
(3) 1,001 - 4,999 Gross Reg. Tons	\$ 122.00
(4) 5,000 Gross Reg. Tons and over	\$ 162.00

(See WAC 318-04-090 for Effective Dates of 5% Annual Increases)

**(F) On Passenger Vessels Engaged as International Ferry Boats Subsequent to Date of Filing of this Rule-Making Order With the Code Reviser's Office**

\$75.00

The assessment levied on all vessels, or the owners or operators thereof, which transit upon the portion of the Columbia River that runs between the states of Washington and Oregon, shall be effective on and after January 1, 1992.

Reviser's note: The bracketed material preceding the section above was supplied by the code reviser's office.

Reviser's note: RCW 34.05.395 requires the use of underlining and deletion marks to indicate amendments to existing rules. The rule published above varies from its predecessor in certain respects not indicated by the use of these markings.

**WSR 92-15-051**  
**EMERGENCY RULES**  
**DEPARTMENT OF AGRICULTURE**  
[Order 3003—Filed July 10, 1992, 3:25 p.m.]

Date of Adoption: July 10, 1992.

Purpose: Rules restricting the use of microencapsulated methyl parathion in chapter 16-230 WAC.

Citation of Existing Rules Affected by this Order: Amending WAC 16-230-290.

Statutory Authority for Adoption: Chapters 15.58 and 17.21 RCW.

Pursuant to RCW 34.05.350 the agency for good cause finds that immediate adoption, amendment, or repeal of a rule is necessary for the preservation of the public health, safety, or general welfare, and that observing the time requirements of notice and opportunity to comment upon adoption of a permanent rule would be contrary to the public interest.

Reasons for this Finding: The department has received a large number of complaints concerning bee kills and the use of methyl parathion. The rule amendment will require a written recommendation by a licensed commercial consultant, public consultant or dealer-manager for distribution.

Effective Date of Rule: Immediately.

July 10, 1992  
C. Alan Pettibone  
Director

**AMENDATORY SECTION** (Amending Order 1573, filed 4/21/78)

**WAC 16-230-290 DISTRIBUTION.** (1) Microencapsulated methyl parathion shall not be distributed unless the purchaser has obtained a written recommendation: PROVIDED, That this shall not apply to applications performed by a licensed commercial applicator or public operator ((only by licensed pesticide dealers to certified applicators or their authorized representative. Microencapsulated methyl parathion shall be applied only by certified applicators or by persons under the direct supervision of a certified applicator)).

(2) A written recommendation shall be prepared by a licensed commercial pest control consultant, public pest control consultant, or pesticide dealer-manager and shall include the following information:

- (a) Customer name;
- (b) Crop or site to be treated;
- (c) Number of acres to be treated;
- (d) Pest(s) to be controlled;
- (e) Rate per acre and dilution of microencapsulated methyl parathion to be used;
- (f) Any special precautions to be followed; and
- (g) Name and license number of the person making the recommendation.

(3) Pesticide dealers shall keep a copy of the written recommendation on file for a period of one year from the date of distribution.

(4) Pesticide dealers shall provide a copy of the microencapsulated methyl parathion rules to the purchaser at the time of distribution.

**WSR 92-15-052**  
**EMERGENCY RULES**  
**DEPARTMENT OF FISHERIES**  
[Order 92-44—Filed July 10, 1992, 4:51 p.m.]

Date of Adoption: July 10, 1992.

Purpose: Personal use rules.

Citation of Existing Rules Affected by this Order:  
Amending WAC 220-57-435.

Statutory Authority for Adoption: RCW 75.08.080.

Pursuant to RCW 34.05.350 the agency for good cause finds that immediate adoption, amendment, or repeal of a rule is necessary for the preservation of the public health, safety, or general welfare, and that observing the time requirements of notice and opportunity to comment upon adoption of a permanent rule would be contrary to the public interest.

Reasons for this Finding: Salmon presence in the area adjacent to the steelhead rearing ponds has created a disorderly fishery which affects conservation.

Effective Date of Rule: Immediately.

July 10, 1992  
Robert Turner  
Director

**NEW SECTION**

**WAC 220-57-43500G SKYKOMISH RIVER.** Notwithstanding the provisions of WAC 220-57-435, effective immediately through July 31, 1992, it is unlawful to fish for or possess salmon taken from those waters of the Skykomish River upstream from a point 1,500 feet below the outlet to the Skykomish Steelhead Rearing Ponds (Reiter Pond) to a point 1,000 feet above the outlet to the Skykomish Steelhead Rearing Ponds.

**WSR 92-15-053**  
**NOTICE OF PUBLIC MEETINGS**  
**DEPARTMENT OF AGRICULTURE**  
**(Egg Commission)**  
[Memorandum—July 2, 1992]

The Washington Egg Commission will meet on Wednesday, July 22, 1992, at Evans/Kraft, Inc., 190 Queen Anne North, Seattle, WA. The meeting will begin at 10:00 a.m. and conclude at approximately 1:30 p.m.

All members are encouraged to attend. Please contact the Washington Egg Commission office if you are planning on attending this meeting. We need to have a count for the lunch. Box lunches will be ordered according to the number of people attending.

**WSR 92-15-054**  
**NOTICE OF PUBLIC MEETINGS**  
**EDMONDS COMMUNITY COLLEGE**  
[Memorandum—July 13, 1992]

Tuesday, July 14, 1992  
Lynnwood Hall, Room 424  
4:30 - 5:40

The facilities for this meeting are free of mobility barriers and interpreters for deaf individuals and brailled or taped information for blind individuals will be provided upon request when adequate notice is given.

**WSR 92-15-055**  
**PROPOSED RULES**  
**GAMBLING COMMISSION**  
[Filed July 13, 1992, 11:12 a.m.]

Original Notice.

Title of Rule: WAC 230-04-201 Fees, 230-08-180 Annual activity reports by commercial amusement game



operators, 230-08-240 Annual activity reports by commercial amusement game operators, and 230-20-670 Commercial amusement games—Operating requirements.

Purpose: Clarify fees and reporting requirements for amusement game operations.

Statutory Authority for Adoption: RCW 9.46.070.

Statute Being Implemented: RCW 9.46.0331.

Summary: See Purpose above.

Reasons Supporting Proposal: See Purpose above.

Name of Agency Personnel Responsible for Drafting:

Sharon M. Tolton, Rules Coordinator, Lacey, 438-7685; Implementation: Frank L. Miller, Director, Lacey, 438-7640; and Enforcement: Neal S. Nunamaker, Deputy Director, Lacey, 438-7690.

Name of Proponent: Washington State Gambling Commission, governmental.

Rule is not necessitated by federal law, federal or state court decision.

Explanation of Rule, its Purpose, and Anticipated Effects: See Purpose above.

Proposal Changes the Following Existing Rules: See Purpose above.

No small business economic impact statement is required for this proposal by chapter 19.85 RCW.

Hearing Location: Westwater Inn, 2300 Evergreen Park Drive S.W., Olympia, WA 98502, on October 7, 1992, at 10:00 a.m.

Date of Intended Adoption: October 9, 1992.

July 13, 1992  
Sharon M. Tolton  
Rules Coordinator

AMENDATORY SECTION (Amending Order 227, filed 9/18/91, effective 10/19/91)

WAC 230-04-201 FEES. Tables 1 and 2 contain the fees that shall be paid to the commission for gambling licenses, permits, miscellaneous changes, and special investigative and inspection services.

Table 1. (For bona fide nonprofit/charitable organizations)

LICENSE TYPE	DEFINITION	SEE
1. AMUSEMENT GAMES	(Fee based on annual gross receipts)	
Class A	Up to \$ 5,000	\$ 50
Class B	Up to \$ 15,000	150
Class C	Up to \$ 25,000	250
Class D	Up to \$ 50,000	400
Class E	over \$ 50,000	700
2. BINGO GROUP	(Fee based on annual gross gambling receipts)	
I	CLASS	
	Class A	Up to \$15,000
	Class B	\$ 15,001 to 50,000
	Class C	\$ 50,001 to 100,000
	Class D	\$ 100,001 to 300,000
	Class E	\$ 300,001 to 500,000
	Class F	\$ 500,001 to 1,000,000
II	Class G	\$ 1,000,001 to 1,500,000
	Class H	\$ 1,500,001 to 2,000,000
	Class I	\$ 2,000,001 to 2,500,000
	Class J	\$ 2,500,001 to 3,000,000
III	Class K	\$ 3,000,001 to 3,500,000
	Class L	\$ 3,500,001 to 4,000,000
	Class M	Over \$4,000,000
3. BINGO GAME MANAGER	Original	\$ 150
	Renewal	75
4. CARD GAMES		
Class A	General (fee to play charged)	\$ 500
Class B	Limited card games - to hearts, rummy, mah-jongg, pitch, pinochle, and/or cribbage - (fee to play charged)	150
Class C	Tournament only - no more than ten consec. days per tournament	50
Class D	General (no fee to play charged)	50
Class R	Primarily for recreation (WAC 230-04-199)	25
5. CHANGES		
NAME	(See WAC 230-04-310)	\$ 25
LOCATION	(See WAC 230-04-320)	25
FEE	(Reno Nite date(s)/time(s))	
	(See WAC 230-04-325)	25
LICENSE CLASS	(See WAC 230-04-260) New class fee, less previous fee paid, plus	25

LICENSE TYPE	DEFINITION	FEE
DUPLICATE LICENSE REPLACEMENT IDENTIFICATION STAMPS	(See WAC 230-04-290) (See WAC 230-30-016)	25 25
6. FUND RAISING EVENT		
Class A	One event not more than 24 consec. hrs.	\$ 300
Class B	One event not more than 72 consec. hrs.	500
Class C	Additional participant in joint event (not lead organization)	150
Class D	Fund Raising Event Equipment Distributor - Rents or leases, equipment for fund raising event or recreational gaming activity more than 4 times per year.	200
Class E	Fund Raising Event Equipment Distributor - Rents or leases equipment for fund raising event or recreational gaming activity more than 10 times per year. NOTE: Charitable and nonprofit organizations licensed to conduct fund raising events may rent equipment up to four occasions without getting licensed as a distributor.	500
7. PERMITS	Agricultural fair/special property bingo One location and event only (see WAC 230-04-191) Recreational gaming activity permit (RGA) (see WAC 230-25-330 and 230-02-505)	\$ 25 50
8. PUNCHBOARDS/ PULL TABS	(Fee based on annual gross gambling receipts) (One Time Variance)	
Class A	Up to \$ 50,000	\$ 475
Class B	Up to \$ 100,000	850
Class C	Up to \$ 200,000	1,600
Class D	Up to \$ 300,000	2,325
Class E	Up to \$ 400,000	3,000
Class F	Up to \$ 500,000	3,625
Class G	Up to \$ 600,000	4,200
Class H	Up to \$ 700,000	4,725
Class I	Up to \$ 800,000	5,200
Class J	Up to \$ 1,000,000	5,900
Class K	Up to \$ 1,250,000	6,550
Class L	Up to \$ 1,500,000	7,150
Class M	Up to \$ 1,750,000	7,650
Class N	Up to \$ 2,000,000	8,100
Class O	Over \$2,000,000	8,900
	A licensee will be allowed a one-time variance for each license class without having to upgrade or pay the penalties set forth in WAC 230-04-260; Provided, a licensee utilizing the variance shall be required to upgrade upon recertification.	
9. RAFFLES	(Fee based on annual gross gambling receipts)	
Class A	Up to \$ 5,000	\$ 50
Class B	Up to \$ 10,000	150
Class C	Up to \$ 25,000	300
Class D	Up to \$ 50,000	500
Class E	Up to \$ 75,000	800
Class F	Over \$ 75,000	1,200
10. SEPARATE PREMISES BINGO	Occasion (see WAC 230-04-300)	\$ 25
11. SPECIAL FEES		
INVESTIGATION IDENTIFICATION AND INSPECTION STAMP	(Sec WAC 230-04-240) (See WAC 230-30-015 and 230-30-030)	As required As required
EXCEEDING LICENSE CLASS	(See WAC 230-04-260) In addition to all normal license fees, a licensee may be assessed an exceeding class fee for a present or previous license year, not to exceed 50% of the difference between the present class fee and the new license class or \$1,000, whichever is less.	As required

LICENSE TYPE	DEFINITION	FEE
12. SIX-MONTH PAYMENT PLAN	<p>The commission may allow an applicant renewing an annual license or an applicant applying for an additional license with a fee of \$800 or above, to pay a license fee in two payments.</p> <p>SIX-MONTH PAYMENT PLAN PROCEDURE:                      The administrative processing fee, plus the first half of the annual license fee must be submitted at the time of application/renewal. The second half payment must be submitted and received in the commission's Olympia headquarters office, prior to the expiration date of the first six-month period: Provided, That participants electing the six-month payment plan will be limited to 50% of the authorized class limitation for annual gross receipts during the first six-month period. Licensees exceeding 50% of the authorized level shall be required to upgrade to the appropriate license class as required by WAC 230-04-260 and pay the full upgrade fee, plus \$25.00.</p>	\$ 25

Table 2. (For commercial stimulant/profit seeking organizations)

LICENSE TYPE	DEFINITION	FEE
1. CARD GAMES		
Class B	(Fee to play charged) limited card games - to hearts, rummy, pitch, pinochle, mah-jongg, and/or cribbage	\$ 150
Class C	Tournament only, no more than ten consec. days per tournament	150
Class D	General (no fee to play charged)	50
Class E	General (fee to play charged)	
E-1	One table only	350
E-2	Up to two tables	600
E-3	Up to three tables	1,000
E-4	Up to four tables	2,000
E-5	Up to five tables	3,000
2. CHANGES		
NAME	(See WAC 230-04-310)	\$ 25
LOCATION	(See WAC 230-04-320)	25
BUSINESS CLASSIFICATION	(Same owners - see WAC 230-04-340(3))	50
LICENSE CLASS	(See WAC 230-04-260) New class fee, less previous fee paid, plus	25
DUPLICATE LICENSE	(See WAC 230-04-290)	25
OWNERSHIP OF STOCK REPLACEMENT	(See WAC 230-04-340(1))	50
IDENTIFICATION STAMPS	(See WAC 230-30-016)	25
LICENSE TRANSFERS	(See WAC 230-04-125, 230-04-340 and 230-04-350)	50
3. DISTRIBUTOR	(Fee based on annual gross sales of gambling related supplies and equipment)	
(a) Class A	Nonpunchboard/Pull Tab Only	\$ 500
Class B	Up to \$250,000	\$1,000
Class C	\$250,001 to \$500,000	\$1,500
Class D	\$500,001 to \$1,000,000	\$2,000
Class E	\$1,000,001 to \$2,500,000	\$2,600
Class F	Over \$2,500,000	\$3,200
	In addition to the annual fee, the commission will assess all applicants the actual costs incurred in conducting the initial investigation and inspection necessary for certification.	
(b) Fund Raising Event Equipment Distributor		
Class A	Rents or leases equipment for fund raising event or recreational gaming activity up to ten times per year.	\$ 200
Class B	Rents or leases equipment for fund raising event or recreational gaming activity more than ten times per year.	\$ 500

LICENSE TYPE	DEFINITION	FEE
4. DISTRIBUTOR'S REPRESENTATIVE	Original Renewal	\$ 200 125
5. MANUFACTURER Class A Class B Class C Class D Class E Class F	(Fee based on annual gross sales of gambling related supplies and equipment) Machines only Up to \$250,000 \$250,001 to \$500,000 \$500,001 to \$1,000,000 \$1,000,001 to \$2,500,000 Over \$2,500,000  In addition to the annual fee, the commission will assess all applicants the actual costs incurred in conducting the initial investigation and inspection necessary for certification.	\$ 500 \$1,000 \$1,500 \$2,000 \$2,600 \$3,200
6. MANUFACTURER'S REPRESENTATIVE	Original Renewal	\$ 200 125
7. PERMITS Class A Class B	Agricultural fair/special property bingo One location and event only (see WAC 230-04-191) Annual permit for specified different events and locations (see WAC 230-04-193)	\$ 25 150
8. PUBLIC CARDROOM EMPLOYEE	Original Renewal	\$ 150 75
9. PUNCHBOARDS/ PULL TABS Class A Class B Class C Class D Class E Class F Class G Class H Class I Class J Class K Class L Class M Class N Class O	(Fee based on annual gross gambling receipts)  Up to \$ 50,000 Up to \$ 100,000 Up to \$ 200,000 Up to \$ 300,000 Up to \$ 400,000 Up to \$ 500,000 Up to \$ 600,000 Up to \$ 700,000 Up to \$ 800,000 Up to \$ 1,000,000 Up to \$ 1,250,000 Up to \$ 1,500,000 Up to \$ 1,750,000 Up to \$ 2,000,000 Over \$2,000,000  (One time variance) \$ 5,000 \$ 5,000 \$10,000 \$10,000 \$10,000 \$10,000 \$10,000 \$10,000 \$10,000 \$20,000 \$25,000 \$25,000 \$25,000 \$25,000 Nonapplicable	\$ 475 850 1,600 2,325 3,000 3,625 4,200 4,725 5,200 5,900 6,550 7,150 7,650 8,100 8,900
10. SPECIAL FEES INVESTIGATION IDENTIFICATION AND INSPECTION STAMP EXCEEDING LICENSE CLASS  REVIEW/EVALUATION/APPROVAL OF AMUSEMENT GAMES OR DEVICES	(See WAC 230-04-240)  (See WAC 230-30-015 and 230-30-030) (See WAC 230-04-260) In addition to all normal license fees, a licensee may be assessed an exceeding class fee for a present or previous license year, not to exceed 50% of the difference between the present class fee and the new license class or \$1,000, whichever is less.  (See WAC 230-20-605)	As required As required As required  \$ 100

LICENSE TYPE	DEFINITION	FEE
11. COMMERCIAL AMUSEMENT GAMES		
*Class A	((Up to \$10,000)) Premises only	**\$250/100
Class B	Up to \$50,000	\$ ((500)) 350
Class C	Up to \$100,000	900
Class D	Up to \$250,000	2,000
Class E	Up to \$500,000	3,500
Class F	Up to \$1,000,000	6,000
Class G	((Up to \$1,500,000)) Over \$1,000,000	7,500
((Class H	Up to \$2,000,000	10,000
Class I	Over \$2,000,000	12,000
	<p>* Restricts Class A amusement games to only one location for the original license fee of \$250.) * Allows the owner of any location qualified under WAC 230-04-138 (1)(f), (g), (h), or (i) to enter into a contract with a Class B or above commercial amusement game licensee to locate and operate amusement games on their premises.</p> <p>** Provides for ((the submission of a reduced fee of \$100)) a fee reduction of \$150 when:                      -Renewing an annual license;                      -Applying for an additional license(s); and/or                      -Applying for multiple licenses.</p>	
12. SIX-MONTH PAYMENT PLAN	<p>The commission may allow an applicant renewing an annual license or an applicant applying for an additional license with a fee of \$800 or above, to pay a license fee in two payments.</p> <p>SIX-MONTH PAYMENT PLAN PROCEDURE:                      The administrative processing fee, plus the first half of the annual license fee must be submitted at the time of application/renewal. The second half payment must be submitted and received in the commission's Olympia headquarters office, prior to the expiration date of the first six-month period: Provided, That participants electing the six-month payment plan will be limited to 50% of the authorized class limitation for annual gross receipts during the first six-month period. Licensees exceeding 50% of the authorized level shall be required to upgrade to the appropriate license class as required by WAC 230-04-260 and pay the full upgrade fee, plus \$25.00.</p>	\$ 25

**AMENDATORY SECTION** (Amending Order 227, filed 9/18/91, effective 10/19/91).

WAC 230-08-180 ((**QUARTERLY**)) ANNUAL ACTIVITY REPORTS BY COMMERCIAL AMUSEMENT GAME OPERATORS. (License Class ((E)) B and above) (1) Each licensee for the operation of commercial amusement games Class ((E)) B and above shall submit an activity report to the commission concerning the operation of the licensed activity and other matters set forth below ((during each of the following periods of the year:

- (a) January 1st through March 31st;
- (b) April 1st through June 30th;
- (c) July 1st through September 30th; and
- (d) October 1st through December 31st).

(2) The report form shall be furnished by the commission and the completed report shall be received in the office of the commission or postmarked no later than ((60)) sixty days following the ((end of the period for which it is made)) license expiration date.

(3) The report shall be signed by the highest ranking executive officer or their designee. If the report is prepared by someone other than the licensee or their employee, then the preparer's name and business telephone number must be provided.

(4) ((If the licensee does not renew his license, then he shall file a report for the period between the previous report filed and the expiration date of his license:

(5)) The report shall be completed in accordance with the related instructions furnished with the report. The report shall include the following:

- (a) The total gross gambling receipts;
- (b) The total cost to the licensee of all prizes awarded;
- (c) Full details of all expenses related to the purchase and operation of amusement games;
- (d) Total net gambling income;
- ((6)) (5) In addition to the above, commercial amusement game ((operators)) licensees operating amusement games at locations on a temporary basis set forth in WAC 230-04-138 ((shall provide)) (1)(a), (d), or (e) or as authorized by WAC 230-20-670(2) shall provide for each separate location:
  - (a) The ((business)) name and address of ((each location)) the business and/or event;
  - (b) The total gross gambling receipts received; and
  - (c) The amount of funds distributed to ((each licensee)) the premise/location owner.

**REPEALER**

The following section of the Washington Administrative Code is repealed:

WAC 230-08-240 ANNUAL ACTIVITY REPORTS BY COMMERCIAL AMUSEMENT GAME OPERATORS CLASS A AND B.

AMENDATORY SECTION (Amending Order 227, filed 9/18/91, effective 10/19/91)

WAC 230-20-670 COMMERCIAL AMUSEMENT GAMES—OPERATING REQUIREMENTS. (1) Each location where commercial amusement games are operated shall be required to obtain a commercial amusement game license.

(2) A person licensed (~~as a~~) for Class A (premise only) commercial amusement games (~~operator~~) may enter into a contract with a Class B or above commercial amusement game licensee(s) to operate amusement games on their premises. The contract must be written and specific in terms, setting out the time of the contract, revenue sharing plan and all expenses to be borne by each party: PROVIDED, That the revenue sharing plan may be based on a percentage of revenue generated by the activity if the method of distribution is specific. All contracts regarding the operation of amusement games shall be submitted to the commission and become part of the licensee file.

(3) It shall be the responsibility of the Class B or above commercial amusement game operator (~~providing the games~~) to ensure that each premises that they locate games is licensed with the commission prior to operating at that location.

**WSR 92-15-056****PERMANENT RULES****DEPARTMENT OF AGRICULTURE**

[Filed July 13, 1992, 1:34 p.m.]

Date of Adoption: July 13, 1992.

Purpose: To update the existing grade standards to more accurately reflect current marketing conditions of the apple industry and to establish minimum maturity requirements of the Granny Smith variety.

Citation of Existing Rules Affected by this Order: Amending chapter 16-403 WAC.

Statutory Authority for Adoption: Chapter 15.17 RCW.

Pursuant to notice filed as WSR 92-11-074 on May 20, 1992.

Effective Date of Rule: Thirty-one days after filing.

July 13, 1991 [1992]  
Michael V. Schwisow  
Deputy  
for C. Alan Pettibone  
Director

NEW SECTION

WAC 16-403-143 GRANNY SMITH—STARCH-IODINE REQUIREMENTS. Prior to the general release date for harvest of the crop of the current growing season, as established by the Delicious maturity committee of the Washington state horticultural association, shipment shall not be allowed of apples of the Granny Smith variety which fail to meet the stage of maturity as indicated by starch-iodine rating of 1.2 on the Cascade Analytical Inc. chart: PROVIDED, That any such lot of apples may be shipped if not more than ten percent of the apples tested fail to meet the 1.2 rating.

AMENDATORY SECTION (Amending Order 1892, filed 6/25/86)

WAC 16-403-160 GREEN OR YELLOW VARIETIES—WASHINGTON EXTRA FANCY. Washington extra fancy consists of apples of one variety

which are mature but not overripe, carefully hand picked, clean, fairly well formed(~~(-PROVIDED, That the Golden Delicious variety shall be fairly well formed)~~); free from decay, internal browning, internal breakdown, scald, scab, bitter pit, Jonathan spot, freezing injury, visible watercore, broken skins and bruises except those which are slight and incident to proper handling and packing. The apples are also free from slightly rough or rough russeting, provided, russeting other than rough or bark-like russeting materially affecting the appearance of the apple shall be permitted in the stem cavity or calyx basin if it cannot be seen when the apple is placed stem end or calyx end down on a flat surface. The apples are also free from injury caused by smooth net-like russeting, smooth solid russeting, sunburn or sprayburn, limb rubs, hail, drought spots, scars, disease, insects, stem or calyx cracks, or other means; and free from damage by invisible watercore after January 31st of the year following the year of production. Each apple of this grade has the amount of color specified in WAC 16-403-175 for the variety.

AMENDATORY SECTION (Amending Order 2032, filed 4/11/90, effective 5/12/90)

WAC 16-403-190 TOLERANCES. In order to allow for variations incident to proper grading and handling in each of the foregoing grades, the following tolerances are provided as specified:

(1) Defects: Washington extra fancy, Washington fancy and Washington C grade.

Ten percent of the apples in any lot may fail to meet the requirements of the grade, but not more than one-half of this amount, or 5 percent, shall be allowed for apples which are seriously damaged, including therein not more than one percent for apples affected by decay or internal breakdown.

(2) When applying the foregoing tolerances to combination grades, no part of any tolerance shall be allowed to reduce, for the lot as a whole, the percent of apples of the higher grade required in the combination.

Combinations requiring 80 percent of the higher grade for the lot shall have not less than 65 percent of the higher grade in individual samples.

Combinations requiring 50 percent of the higher grade for the lot shall have not less than 40 percent of the higher grade in individual samples.

(3) Size. When size is designated by the numerical count for a container, not more than 5 percent of the apples in the lot may vary more than 1/4 inch in diameter. When size is designated by minimum or maximum diameter or weight, not more than 5 percent of the apples in any lot may be smaller than the designated minimum and not more than 10 percent may be larger than the designated maximum.

(4) Firmness. Not more than ten percent of the apples in any lot of Red Delicious, Delicious, and Golden Delicious varieties shall fail to meet the firmness requirements as defined in WAC 16-403-142.

AMENDATORY SECTION (Amending Order 1475, filed 7/2/76)

WAC 16-403-200 CALCULATION OF PERCENTAGES. (1) When the numerical count is marked on the container, percentages shall be calculated on the basis of count.

(2) When the minimum diameter and/or minimum weight of individual apples, or minimum and maximum diameters and/or weights of individual apples are marked on a container or when the apples are jumbled in a container or in bulk, percentages shall be calculated on the basis of weight or an equivalent basis.

AMENDATORY SECTION (Amending Order 1374, filed 7/26/74, effective 9/1/74)

WAC 16-403-220 MARKING REQUIREMENTS—OPEN OR CLOSED CONTAINERS. (1) The containers shall bear the correct name of the variety or "variety unknown," the name of the grower, packer, or distributor, and his address, the grade, the numerical count or the minimum diameter of apples packed in a closed container, and the net contents either in terms of dry measure or weight. The minimum weight of individual apples within the container may be stated in lieu of, in combination with, or in addition to, minimum diameter as a declaration of size. All open containers and consumer packages must bear statement of net weight ((without exception)) or volume.

(a) When the numerical count is not shown, the minimum diameter or minimum weight of individual apples shall be plainly stamped, stenciled, or otherwise marked on the container in terms of whole inches, or whole inches and not less than eight inch fractions thereof or in terms of whole grams.

(b) When used in combination with minimum diameter as a size designation, the following minimum fruit weights shall be used:

<u>Red Delicious</u>	<u>Golden Delicious</u>
<u>2 1/8 in. or 65 grams</u>	<u>63 grams</u>
<u>2 1/4 in. or 75 grams</u>	<u>70 grams</u>
<u>2 3/8 in. or 84 grams</u>	<u>82 grams</u>
<u>2 1/2 in. or 100 grams</u>	<u>95 grams</u>
<u>2 5/8 in. or 115 grams</u>	<u>109 grams</u>
<u>2 3/4 in. or 139 grams</u>	<u>134 grams</u>

(c) The word "minimum," or its abbreviation, when following a diameter size or weight size marking, means that the apples are of the size marked or larger.

(2) Over-wrapped consumer units may be marked with count, if all specimens can be counted.

(3) Any of these marks may be placed on either the end or side of the container. (California requires end markings.)

(4) When containers are marked as to number, each container shall contain the correct number of apples designated by the markings.

(5) Grade markings on consumer-type packages must be at least one-fourth inch in height.

AMENDATORY SECTION (Amending Order 1374, filed 7/26/74, effective 9/1/74)

WAC 16-403-240 DIAMETER OR FRUIT WEIGHT. When measuring for minimum size, "diameter" means the greatest dimension of the apple measured at right angles to a line from stem to blossom end. When measuring for maximum size "diameter" means the smallest dimension of the apple determined by passing the apple through a round opening in any position. When measuring for minimum weight as a designation of fruit size, the individual apple must meet the minimum weight designation as marked on the container or package.

**WSR 92-15-057**  
**PERMANENT RULES**  
**DEPARTMENT OF REVENUE**  
[Filed July 13, 1992, 2:31 p.m.]

Date of Adoption: June 26, 1992.

Purpose: To comply with newly enacted amendatory legislation.

Citation of Existing Rules Affected by this Order: Amending WAC 458-18-010 and 458-18-020.

Statutory Authority for Adoption: RCW 84.38.180.

Pursuant to notice filed as WSR 92-04-078 on February 5, 1992.

Effective Date of Rule: Thirty-one days after filing.

June 25, 1992  
William N. Rice  
Assistant Director

AMENDATORY SECTION (Amending Order PT 88-9, filed 6/9/88)

WAC 458-18-010 DEFERRAL OF SPECIAL ASSESSMENTS AND/OR PROPERTY TAXES—DEFINITIONS. (1) "Claimant" means a person who ~~((is receiving a property tax exemption under RCW 84.36.381 through 84.36.389 and who))~~ either elects or is required under RCW 84.64.030 or 84.64.050 to defer payment of the special assessments and/or real property taxes on his or her residence. If two individuals of a household seek to defer, they must determine between them as to who the claimant shall be.

(2) "Department" means the Washington state department of revenue.

(3) "Equity value" means the amount by which the true and fair value of a residence as shown on the county property tax rolls for the year the deferral is to be made exceeds the total amount of all liens, obligations and encumbrances against the property excluding the deferral liens.

(4) "Special assessment" means the charge or obligation imposed by a city, town, county or other municipal corporation upon property specially benefited by a local improvement as provided in chapters:

(a) 35.44 RCW—Local improvements—Assessments and reassessments (cities and towns)

(b) 36.88 RCW—County road improvement districts (counties)

(c) 36.94 RCW—Sewer, water and drainage systems (counties)

(d) 50.08 RCW—Powers (port districts)

(e) 54.16 RCW—Powers (public utility districts)

(f) 56.20 RCW—Utility local improvement districts (sewer districts)

(g) 57.16 RCW—Comprehensive plan—Local improvement districts (water districts)

(h) 86.09 RCW—Flood control districts—1937 Act (flood control)

(i) 87.03 RCW—Irrigation districts generally (irrigation)

along with any others that may be relevant.

The term does not include the charge or obligation for services specially benefiting property not involving the construction of permanent improvements to real property, e.g., mosquito control, weed control, etc.

(5) "Real property taxes" means ad valorem property taxes levied on a residence in this state. It includes foreclosure costs, interest and penalties accrued to the date the declaration for deferral is filed.

(6) "Fire and casualty insurance" means a policy with an insurer that is authorized to insure property in this state by the state insurance commission.

(7) "Lien" means any interest in property given to secure payment of a debt or performance of an obligation, and shall include a deed of trust. It shall include the total amount of assessments and/or property taxes deferred and the interest thereon.

**AMENDATORY SECTION** (Amending Order PT 88-9, filed 6/9/88)

WAC 458-18-020 DEFERRAL OF SPECIAL ASSESSMENTS AND/OR PROPERTY TAXES—QUALIFICATIONS FOR DEFERRAL. A person may defer payment of special assessments and/or real property taxes on ~~((his property that is receiving an exemption under RCW 84.36.381 through 84.36.389 on))~~ up to eighty percent of the amount of his equity value in said property if the following conditions are met:

(1) The claimant must have owned, at the time of filing, the residence on which the special assessment and/or real property taxes have been imposed. For purposes of this subsection a residence owned by a marital community or owned by cotenants shall be deemed to be owned by each spouse and cotenant. A claimant who has only a share ownership in cooperative housing, a life estate, a lease for life or a revocable trust does not satisfy the ownership requirement.

(2) If the amount deferred is to exceed one hundred percent of the claimant's equity value in the land or lot only, the claimant must have and keep in force fire and casualty insurance in sufficient amount to protect the interest of the state of Washington and shall designate the state as a loss payee upon said policy. In no case shall the deferred amount exceed the amount of the insured value of the improvement plus the land value.

(3) In the case of special assessment deferral, the claimant must have opted for payment of such special assessments on the installment method if such method was available.

(4) The claimant must meet all requirements for an exemption for the residence under RCW 84.36.381, other than the income requirements, and to the extent eligible, must have first applied for the exemptions under RCW 84.36.381 through 84.36.389 prior to filing a declaration to defer.

(5) The claimant must have a combined disposable income, as defined in RCW 84.36.383 and WAC 458-16-010 and 458-16-013, of thirty thousand dollars or less.

**WSR 92-15-058**

**PERMANENT RULES**

**DEPARTMENT OF REVENUE**

[Filed July 13, 1992, 2:33 p.m.]

Date of Adoption: June 26, 1992.

Purpose: To comply with newly enacted amendatory legislation.

Citation of Existing Rules Affected by this Order: Amending WAC 458-16-013 and 458-16-020.

Statutory Authority for Adoption: RCW 84.36.389 and 84.36.865.

Pursuant to notice filed as WSR 92-04-079 on February 5, 1992.

Changes Other than Editing from Proposed to Adopted Version: Added "and thereafter" after "1992" in subsection (6) of WAC 458-16-013.

Effective Date of Rule: Thirty-one days after filing.

June 25, 1992

William N. Rice  
Assistant Director

**AMENDATORY SECTION** (Amending Order PT 83-5, filed 9/14/83)

WAC 458-16-013 SENIOR CITIZENS AND DISABLED PERSONS EXEMPTION—DISPOSABLE INCOME. "Disposable income" means the adjusted gross income as defined in WAC 458-16-012 and in the Federal Internal Revenue Code as amended prior to January 1, ~~((+1980))~~ 1989, less certain income and expenses as defined below and plus other items to the extent they are not included in or have been deducted from adjusted gross income. (RCW 84.36.383)

(1) Disposable income is adjusted gross income plus the following to the extent they were deducted or not included in adjusted gross income:

(a) Capital gains, except gain from the sale of a principal residence to the extent such gain is reinvested in a different principal residence, including reinvestment in a life estate or lease for life in a retirement residence;

(b) Amounts deducted for loss;

(c) Amounts deducted for depreciation;

(d) Pension and annuity receipts;

(e) Military pay and benefits other than attendant-care and medical-aid payments;

(f) Veterans benefits other than attendant-care and medical-aid payments;

(g) Federal Social Security Act and railroad retirement((s)) benefits;



(h) Dividend receipts;

(i) Interest received on state and municipal bonds.

(2) Capital gains is the difference between the cost of ~~((the))~~ real property plus the cost of improvements, and the selling price of the property less any sales expense. If payment of the capital gain to the seller is over a period of time, the amount to be added to disposable income will be calculated over the same period.

(3) The exclusions ~~((of))~~ contained in subsections (1)(e) and (f) of this section for attendant-care and medical-aid payments and the amounts received as payment for the care of dependent children must be verified by the applicable branch of the military service or the veterans administration before the deduction is allowed. If the amount for the military and veterans attendant-care and medical-aid payments in subsection (1)(e) and (f) of this section cannot be determined by the applicable branch of the military service or the veterans administration, then the actual amount expended by the military person or veteran for such care and aid, may be deducted from the amount received.

(4) The nonreimbursed amounts paid during the ~~((previous))~~ preceding calendar year for the care and treatment of either spouse, or cotenant, in a nursing home shall not be included in disposable income.

(5) The nonreimbursed amounts paid during the preceding calendar year for the treatment or care of either spouse, or cotenant, received in the home shall not be included in disposable income. Amounts paid for in-home treatment or care will be excluded if such treatment or care is the same as or similar to that which would be excluded if provided in the normal course of treatment or care in a nursing home.

(a) The payments must meet at least one of the following criteria:

(i) The payments were for medical treatment or care, or physical therapy received in the home; or

(ii) The payments were made for any of the following materials: Food, oxygen, or other lawful substances taken internally or applied externally, brought in to the home as part of a necessary or appropriate in-home service which is being rendered (such as a meals on wheels type program), necessary medical supplies, special needs furniture or equipment (such as wheel chairs, hospital beds, or therapy equipment); or

(iii) The payments were made for attendant care and/or to assist the claimant, or the claimant's spouse or cotenant, with household tasks, and such personal care tasks as meal preparation, eating, dressing, personal hygiene, specialized body care, transfer, positioning, ambulation, bathing, toileting, self-medication a person provides for himself or herself, or such other tasks as may be necessary to maintain a person in his or her own home, but shall not include amounts expended for improvements or repair of the home itself.

(b) Payments made for services received in the home must be in a reasonable amount and be paid at a rate comparable to the rate of pay normally paid in the local area for similar services.

(c) The person to whom the payments are made for services rendered need not be specially licensed to provide the services.

(6) Subsection (5) of this section and the amendment to subsection (1)(a) of this section shall be effective for taxes payable in 1992 and thereafter, pursuant to the amendment to RCW 84.36.383 as amended in chapter 213, Laws of 1991.

AMENDATORY SECTION (Amending Order PT 83-5, filed 9/14/83)

WAC 458-16-020 SENIOR CITIZEN AND DISABLED PERSONS EXEMPTION—QUALIFICATIONS FOR EXEMPTION. A person shall be exempt from any legal obligation to pay all or a portion of the real property taxes due and payable in the years following the year in which a claim is filed if the following qualifications are met:

(1) The property taxes must have been imposed upon a residence which was occupied by the person claiming the exemption as a principal place of residence as of January 1 of the year in which the claim is filed.

(2) The person claiming the exemption must have owned as defined in WAC 458-16-010, at the time of filing, the residence on which the property taxes have been imposed.

(3) The person claiming the exemption must ~~((have been))~~ be at the time of filing:

(a) Sixty-one years of age or older on ~~((January 1))~~ December 31 of the year in which the exemption claim is filed; or

(b) Retired from regular gainful employment by reason of physical disability; or

(c) A surviving spouse of a person who was receiving the exemption at the time of ~~((their))~~ the person's death, if the surviving spouse was fifty-seven years old, or attains the age of fifty-seven in the year of the claimant's death, and otherwise meets the requirements contained in this section.

(4) The amount that the person shall be exempt from an obligation to pay shall be calculated on the basis of combined disposable income, as defined in RCW 84.36.383 and WAC 458-16-010 through 458-16-013. If the person claiming the exemption was retired for two months or more of the preceding year, the combined disposable income of such person including his or her spouse and any cotenant shall be calculated by multiplying the average monthly combined disposable income of such person during the months such person was retired by twelve.

(5) Confinement of the person to a hospital or nursing home will not jeopardize the exemption if the residence is temporarily unoccupied or if the residence is occupied by a spouse and/or person financially dependent on the claimant for support, or by a person residing there for caretaker or security reasons only and the claimant is not receiving monetary consideration for this occupancy.

**WSR 92-15-059**  
**PROPOSED RULES**  
**DEPARTMENT OF**  
**SOCIAL AND HEALTH SERVICES**  
**(Public Assistance)**

[Filed July 14, 1992, 8:16 a.m.]

Continuance of WSR 92-14-050.

Title of Rule: Repealing WAC 388-29-005 Fair hearing and 388-33-377 Grant continuation pending fair hearing; amending WAC 388-33-389 Grievance procedure—Applicants and recipients of public assistance, medical assistance, and social services administered by Title 388 WAC; and new section WAC 388-33-379 Continuance of assistance—Fair hearing.

Purpose: Update terminology relating to titles used in the fair hearing process.

Name of Proponent: Department of Social and Health Services, governmental.

Explanation of Rule, its Purpose, and Anticipated Effects: Same as above.

Proposal Changes the Following Existing Rules: See above.

No small business economic impact statement is required for this proposal by chapter 19.85 RCW.

Date of Intended Adoption: August 7, 1992.

July 14, 1992

Leslie F. James, Director  
Administrative Services

**WSR 92-15-060**  
**PROPOSED RULES**  
**DEPARTMENT OF AGRICULTURE**

[Filed July 14, 1992, 11:05 a.m.]

Original Notice.

Title of Rule: Chapter 16-146 WAC, Food processors.

Purpose: To permanently change the expiration date of the license to June 30.

Statutory Authority for Adoption: RCW 69.07.040.

Statute Being Implemented: Chapter 69.07 RCW.

Summary: To permanently change the expiration date of the food processor's license to June 30.

Reasons Supporting Proposal: Provide continuance of license fee collection under RCW 69.07.040 as amended March 9, 1992, to provide enhanced inspection activities.

Name of Agency Personnel Responsible for Drafting, Implementation and Enforcement: Verne Hedlund, 2627B Parkmont Lane S.W., Olympia, WA, 753-5043.

Name of Proponent: Department of Agriculture, governmental.

Rule is not necessitated by federal law, federal or state court decision.

Explanation of Rule, its Purpose, and Anticipated Effects: This will permanently change the expiration date of food processor's license required under RCW 69.07-.040 from March 31 to June 30. This will provide continuity in licensing requirements and provide continuance

in license fee collection under new fee schedule as established under amendments to RCW 69.07.040 on March 9, 1992.

Proposal does not change existing rules.

No small business economic impact statement is required for this proposal by chapter 19.85 RCW.

Hearing Location: Food Safety and Animal Health Division, 2627B Parkmont Lane S.W., Olympia, WA 98502, on August 26, 1992, at 1:30 p.m.

Submit Written Comments to: Verne Hedlund, P.O. Box 42560, Olympia, WA 98504-2560, by August 26, 1992.

Date of Intended Adoption: September 9, 1992.

July 14, 1992

Michael V. Schwisow  
Deputy Director

Chapter 16-146 WAC  
FOOD PROCESSORS

AMENDATORY SECTION (Amending Order 2091, filed 7/25/91, effective 8/25/91)

WAC 16-146-100 FOOD PROCESSOR LICENSE. Licenses to operate a food processing plant or to process food issued under RCW 69.07.040 shall expire on the (~~31st~~) 30th day of (~~March~~) June of each year.

AMENDATORY SECTION (Amending Order 2091, filed 7/25/91, effective 8/25/91)

WAC 16-146-110 LATE RENEWAL PENALTY FOR FOOD PROCESSOR LICENSE. An additional fee shall be assessed for any license issued under chapter 69.07 RCW for which renewal is not filed by (~~April~~) July 1st in any year.

Reviser's note: RCW 34.05.395 requires the use of underlining and deletion marks to indicate amendments to existing rules. The rule published above varies from its predecessor in certain respects not indicated by the use of these markings.

**WSR 92-15-061**  
**EMERGENCY RULES**  
**DEPARTMENT OF AGRICULTURE**  
[Order 3004—Filed July 14, 1992, 11:09 a.m.]

Date of Adoption: July 14, 1992.

Purpose: To implement collection of new fees for food processor's licenses as provided under RCW 69.07.040. This will enable us to increase our surveillance and inspection of food processors and distributors. It will provide continuity in licensing requirements until permanent order is completed.

Statutory Authority for Adoption: RCW 69.07.040.

Pursuant to RCW 34.05.350 the agency for good cause finds that immediate adoption, amendment, or repeal of a rule is necessary for the preservation of the public health, safety, or general welfare, and that observing the time requirements of notice and opportunity to comment upon adoption of a permanent rule would be contrary to the public interest.

Reasons for this Finding: To implement collection of fees as provided under RCW 69.07.040 as amended March 9, 1992. Fees will provide additional inspectional and sampling activities on food processors and food products to ensure compliance with food safety laws and

rules. To provide continuity in licensing and fee requirements until final order is promulgated.

Effective Date of Rule: Immediately.

July 14, 1992  
Michael V. Schwisow  
Deputy Director

**Chapter 16-146 WAC  
FOOD PROCESSORS**

**AMENDATORY SECTION** (Amending Order 2091, filed 7/25/91, effective 8/25/91)

**WAC 16-146-100 FOOD PROCESSOR LICENSE.** Licenses to operate a food processing plant or to process food issued under RCW 69.07.040 shall expire on the (~~31st~~) day of (~~March~~) June of each year.

**AMENDATORY SECTION** (Amending Order 2091, filed 7/25/91, effective 8/25/91)

**WAC 16-146-110 LATE RENEWAL PENALTY FOR FOOD PROCESSOR LICENSE.** An additional fee shall be assessed for any license issued under chapter 69.07 RCW for which renewal is not filed by (~~April~~) July 1st in any year.

**Reviser's note:** RCW 34.05.395 requires the use of underlining and deletion marks to indicate amendments to existing rules. The rule published above varies from its predecessor in certain respects not indicated by the use of these markings.

**WSR 92-15-062**

**PROPOSED RULES**

**BELLEVUE COMMUNITY COLLEGE**

[Filed July 14, 1992, 1:30 p.m.]

Original Notice.

Title of Rule: Chapter 132H-200 WAC, General operating policies of Community College District VIII.

Purpose: Repeal chapter.

Statutory Authority for Adoption: Chapter 34.05 RCW.

Statute Being Implemented: RCW 28B.50.140.

Summary: Repeals general operating policies as filed in chapter 132H-200 WAC.

Reasons Supporting Proposal: To be in compliance with the Administrative Procedure Act.

Name of Agency Personnel Responsible for Drafting: Phyllis C. Hudson, A201, (206) 641-2302; Implementation and Enforcement: Board of Trustees, A201, (206) 641-2302.

Rule is not necessitated by federal law, federal or state court decision.

Explanation of Rule, its Purpose, and Anticipated Effects: Repeals the current policies and regulations which are being filed under new chapter 132H-133 WAC.

Proposal does not change existing rules.

No small business economic impact statement is required for this proposal by chapter 19.85 RCW.

Hearing Location: Bellevue Community College, 3000 Landerholm Circle S.E., B202A, Bellevue, WA 98007-6484, on September 1, 1992, at 8:00 a.m.

Submit Written Comments to: Phyllis C. Hudson, by August 27, 1992.

Date of Intended Adoption: September 8, 1992.

July 10, 1992  
Phyllis C. Hudson  
Secretary  
Board of Trustees

**REPEALER**

Chapter WAC 132H-200

**WSR 92-15-063**

**PROPOSED RULES**

**BELLEVUE COMMUNITY COLLEGE**

[Filed July 14, 1992, 1:35 p.m.]

Original Notice.

Title of Rule: Chapter 132H-133 WAC, Organization and general operating policies of Community College District VIII.

Purpose: Add new chapter 132H-133 WAC.

Statutory Authority for Adoption: Chapter 34.05 RCW.

Statute Being Implemented: RCW 28B.50.140.

Summary: Add new chapter 132H-200 [132H-133] WAC.

Reasons Supporting Proposal: To be in compliance with Administrative Procedure Act.

Name of Agency Personnel Responsible for Drafting: Phyllis C. Hudson, A201, (206) 641-2302; Implementation and Enforcement: Board of Trustees, A201, (206) 641-2302.

Rule is not necessitated by federal law, federal or state court decision.

Explanation of Rule, its Purpose, and Anticipated Effects: Provides general operating policies of Community College District VIII.

Proposal does not change existing rules.

No small business economic impact statement is required for this proposal by chapter 19.85 RCW.

Hearing Location: Bellevue Community College, 3000 Landerholm Circle S.E., B202A, Bellevue, WA 98007-6484, on September 1, 1992, at 8:00 a.m.

Submit Written Comments to: Phyllis C. Hudson, by August 27, 1992.

Date of Intended Adoption: September 8, 1992.

July 10, 1992  
Phyllis C. Hudson  
Secretary  
Board of Trustees

**CHAPTER 132H-133 WAC  
ORGANIZATION AND GENERAL OPERATING POLICIES OF  
COMMUNITY COLLEGE DISTRICT VIII**

**WAC**

132H-133-010 Title  
132H-133-020 Purpose  
132H-133-040 Organization/operation information  
132H-133-050 Commercial activity policy

[NEW SECTION]

WAC 132H-133-010 TITLE. WAC 132H-133-010 through WAC 132H-133-150 shall be known as the organization and general operating policies of Community College District VIII.

**Reviser's note:** The bracketed material preceding the section above was supplied by the code reviser's office.

[NEW SECTION]

WAC 132H-133-020 PURPOSE. To incorporate those policies that pertain to the campuswide community and not otherwise incorporated in the Washington Administrative Code of Community College District VIII.

**Reviser's note:** The bracketed material preceding the section above was supplied by the code reviser's office.

[NEW SECTION]

WAC 132H-13-040 ORGANIZATION/OPERATION INFORMATION. (1) Organization: Bellevue Community College, Community College District VIII is established in Title 28B.RCW as a public institution of higher education. The institution is governed by a five-member board of trustees, appointed by the governor. The board employs a president, who acts as the chief executive officer of the institution. The president establishes the structure of the administration.

(2) Operation: The administrative office is located at the following address: 3000 Landerholm Circle, S.E., Bellevue, Washington 98007-6484. Educational operations are also located at the following address: 14844 S.E. 22nd Street, Bellevue, Washington 98007-6484. The office hours are 8:00 a.m. to 5:00 p.m., Monday, through Friday, except legal holidays. During the summer months the college operates on an alternate schedule and throughout the year, some evening services are provided. Specific information is available through the college public information office.

(3) Additional and detailed information concerning the educational offerings may be obtained from the catalog, copies of which are available at the following address: Bookstore, 3000 Landerholm Circle, S.E., Bellevue, Washington 98007-6484.

**Reviser's note:** The bracketed material preceding the section above was supplied by the code reviser's office.

**Reviser's note:** The typographical error in the above section occurred in the copy filed by the agency and appears in the Register pursuant to the requirements of RCW 34.08.040.

[NEW SECTION]

WAC 132H-133-050 COMMERCIAL ACTIVITY POLICY. The mission of Community College District VIII, Bellevue Community College, is to provide comprehensive educational programs of the highest quality as provided for in the Community College Act of 1967. These programs will be responsive to the changing needs of the communities and the students served by our district and will be accessible to all those seeking to continue their education.

To promote the mission of Bellevue Community College it is often necessary to engage in commercial activities that provide goods and services that meet special needs of students, faculty, staff and members of the public participating in college activities and events.

Chapter 97 of the Washington Laws of 1987 establishes standards for institutions of higher education to follow in conducting commercial activities. The purpose of these laws is to require institutions of higher education to define the legitimate purposes under which commercial activities may be approved by a college or university and to establish mechanisms for review of such activities. The purpose of the policy statement and standards that follow are to assure that Bellevue Community College pursues commercial activities in compliance with chapter 97, Laws of 1987 and that all commercial activities of the college serve the mission of the college.

(1) POLICY STATEMENT. Bellevue Community College may engage in the providing of goods, services, or facilities for a fee only when such are directly and substantially related to the educational mission of the college. Fees charged for goods, services and facilities shall reflect their full direct and indirect costs, including overhead. They shall also take into account the price of such items in the private marketplace.

(2) APPROVAL AND REVIEW OF COMMERCIAL ACTIVITIES. The dean of administrative services shall be responsible for the approval of new commercial activities and the periodic review of existing ones. It shall

be the responsibility of this officer to assure that each commercial activity meets the criteria established for commercial activities of the college. Proposals for new or altered services shall be approved by the dean of administrative services prior to implementation.

(3) CRITERIA FOR COMMERCIAL ACTIVITIES SERVING MEMBERS OF THE CAMPUS COMMUNITY. Each of the following criteria shall be used in assessing the validity of providing goods or services to members of the campus community:

(a) The goods or services are substantially and directly related to the mission of the college.

(b) Provision of the goods, services or facilities on campus represents a special convenience to the campus community or facilitates extra-curricular activities.

(c) Fees charged for the goods, services or facilities shall take into account the full direct and indirect costs, including overhead. They shall also reflect the costs of such items in the private marketplace.

(d) Procedures adequate to the circumstances shall be observed to ensure that the goods and services are provided only to persons who are students, faculty, staff, or invited guests.

(4) CRITERIA FOR PROVIDING COMMERCIAL ACTIVITIES TO THE EXTERNAL COMMUNITY.

(a) The goods or services provided relate substantially to the mission of the college and are not commonly available or otherwise easily accessible in the private marketplace and for which there is a demand from external community.

(b) Fees charged for the goods, services, or facilities shall take into account the full direct and indirect costs, including overhead. They shall also reflect the price of such items in the private marketplace.

(5) Definitions and limitations. "Commercial activity" means an activity which provides a product or service for a fee which could be obtained from a commercial source. This definition shall be used to determine which activities shall be governed by this policy except that this policy shall not apply to:

(a) The initiation of or changes in academic or vocational programs of instruction in the college's regular, extension, evening or continuing education programs;

(b) Fees for services provided in the practicum aspects of instruction;

(c) Extracurricular programs, including food services, athletic and recreational programs, and performing arts programs.

**Reviser's note:** The bracketed material preceding the section above was supplied by the code reviser's office.

**WSR 92-15-064**

**PERMANENT RULES**

**BOARD OF**

**PILOTAGE COMMISSIONERS**

[Filed July 14, 1992, 1:37 p.m.]

Date of Adoption: July 9, 1992.

Purpose: To clarify the existing rule as to the type of vessels in which the required experience is necessary, requiring experience to be in cargo, tank or passenger vessels transporting cargo or passengers between points. And to clarify that the applicant must have a United States endorsement on the license without restriction prior to application for taking the pilot examination.

Citation of Existing Rules Affected by this Order: Amending WAC 296-116-075.

Statutory Authority for Adoption: RCW 88.16.090(2).

Pursuant to notice filed as WSR 92-12-079 on June 2, 1992.

Effective Date of Rule: Thirty-one days after filing.

July 9, 1992

C. A. Richmond, Jr.  
Chairman

**AMENDATORY SECTION** (Amending WSR 90-17-094, filed 8/20/90, effective 9/20/90)

WAC 296-116-075 QUALIFICATIONS FOR PILOT APPLICANTS. Under the authority of RCW 88.16.090 pilot applicants, in addition to meeting the requirements therein, must hold a first class United States endorsement without restrictions on the United States government license to pilot in the pilotage districts for which the pilot applicant desires to be licensed and meet one of the following additional requirements before taking the Washington state pilotage examination:

(1) ~~One year of service ((as a master of)) in ocean or near coastal waters as a master of cargo, tank, or passenger vessels of 5000 gross tons or more while holding a license as a master of ocean steam or motor vessels of any gross tons or as a master of near coastal steam or motor vessels of any gross tons; or~~

(2) ~~Two years of service ((as a master of)) in ocean or near coastal waters as a master of cargo, tank, or passenger vessels of 450 gross tons or more while holding a license as a master of ocean or near coastal steam or motor vessels of not more than 1600 gross tons; or~~

(3) ~~Two years of service ((as a master of)) in inland ((steam or motor)) waters as a master of cargo, tank, or passenger vessels of 500 gross tons or more while holding a license as a master of ocean, near coastal or inland steam or motor vessels of not more than 1600 gross tons; or~~

(4) ~~Two years of service as a master of towing vessels of 100 gross tons or more while holding a license as a master of ocean, near coastal or inland steam or motor vessels of not more than 1600 gross tons; or~~

(5) ~~Three years of service as a member of an organized professional pilots association or as a U.S. government employed pilot during which period the applicant was actively engaged in piloting. Hold as a minimum a license as a master of ocean, near coastal or inland steam or motor vessels of not more than 1600 gross tons; or~~

(6) ~~((Two years of service as a chief mate of ocean or near coastal vessels of 5000 gross tons or more while holding a license as a master of ocean steam or motor vessels of any gross tons; or~~

~~(7))) Two years of service as a commanding officer of U.S. government vessels of not less than 1000 gross tons and hold a license as either a master of ocean or near coastal steam or motor vessels of any gross tons.~~

(7) As used in this section "cargo, tank, or passenger vessels" shall refer to vessels primarily engaged in the transportation of cargo or passengers between points.

**WSR 92-15-065**

**PROPOSED RULES**

**BELLEVUE COMMUNITY COLLEGE**

[Filed July 14, 1992, 1:52 p.m.]

Original Notice.

Title of Rule: Chapter 132H-121 WAC, General conduct, WAC 132H-121-010 Smoking.

Purpose: Establishes new chapter.

Statutory Authority for Adoption: Chapter 34.05 RCW.

Statute Being Implemented: RCW 28B.50.140.

Summary: Adds new chapter on general conduct.

Reasons Supporting Proposal: Necessary for the preservation of general welfare.

Name of Agency Personnel Responsible for Drafting: Phyllis C. Hudson, A201, (206) 641-2302; Implementation and Enforcement: Board of Trustees, A201, (206) 641-2302.

Rule is not necessitated by federal law, federal or state court decision.

Explanation of Rule, its Purpose, and Anticipated Effects: Provides general conduct policies and regulations for students attending Bellevue Community College.

Proposal does not change existing rules.

No small business economic impact statement is required for this proposal by chapter 19.85 RCW.

Hearing Location: Bellevue Community College, 3000 Landerholm Circle S.E., B202A, Bellevue, WA 98007-6484, on September 1, 1992, at 8:00 a.m.

Submit Written Comments to: Phyllis C. Hudson, by August 27, 1992.

Date of Intended Adoption: September 8, 1992.

July 10, 1992

Phyllis C. Hudson

Secretary

Board of Trustees

**CHAPTER 132H-121 WAC  
GENERAL CONDUCT**

WAC

132H-121-010 Smoking

**NEW SECTION**

WAC 132H-121-010 SMOKING. It shall be the policy of Bellevue Community college, consistent with its efforts to promote wellness, fitness, and a campus environment conducive to work, study and activities for staff, students, and the public, to maintain a smoke/tobacco free indoor campus environment. Use of tobacco products is permitted on campus outside of the buildings; smoking in covered walkways surrounding Main and Upper Campuses shall be restricted to designated smoking areas. Receptacles for smoking materials are provided and are required to be used to maintain litter free campus grounds.

The College recognizes the rights of those who choose to use tobacco and as such does not prohibit the use of tobacco products; it does, however, restrict the use of these materials to areas outside college facilities and vehicles.

**WSR 92-15-066**

**PROPOSED RULES**

**BELLEVUE COMMUNITY COLLEGE**

[Filed July 14, 1992, 1:56 p.m.]

Original Notice.

Title of Rule: Chapter 132H-136 WAC, Library-media center code.

Purpose: Amend and add to chapter 132H-136 WAC. Statutory Authority for Adoption: Chapter 34.05 RCW.

Statute Being Implemented: RCW 28B.50.140.

Summary: Amends and adds to chapter 132H-136 WAC.

Reasons Supporting Proposal: Necessary for the preservation of general welfare as current practices are inconsistent with WAC as filed.

Name of Agency Personnel Responsible for Drafting: Phyllis C. Hudson, A201, (206) 641-2302; Implementation and Enforcement: Board of Trustees, A201, (206) 641-2302.

Rule is not necessitated by federal law, federal or state court decision.

Explanation of Rule, its Purpose, and Anticipated Effects: Provides current policies and regulations for students attending Bellevue Community College.

Proposal Changes the Following Existing Rules: Existing rules are in conflict with current operating practices.

No small business economic impact statement is required for this proposal by chapter 19.85 RCW.

Hearing Location: Bellevue Community College, 3000 Landerholm Circle S.E., B202A, Bellevue, WA 98007-6484, on September 1, 1992, at 8:00 a.m.

Submit Written Comments to: Phyllis C. Hudson, by August 27, 1992.

Date of Intended Adoption: September 8, 1992.

July 10, 1992  
Phyllis C. Hudson  
Secretary  
Board of Trustees

AMENDATORY SECTION (Amending Order 35, filed 10/10/75)

WAC 132H-136-030 FINES. (1) In cases where damage or loss of library material is evident, the offending patron is assessed the replacement cost.

(2) (~~In other instances~~) Where library-media materials are retained by the borrower beyond the designated due date, fines are levied as a sanction to effect the prompt return of items which might be in demand by others.

(3) When materials are not returned, or fines not paid, holds are placed on the transcript records of those involved—only as a sanction to cause the ultimate return of library-media material in order to protect the integrity of the library-media collection.

(4) In extreme cases, when expensive or valuable items are involved, the provisions of RCW 27.12.340 may be invoked.

NEW SECTION

WAC 132H-136-035 SCHEDULE OF FINES. The college should publish the fines that are to be charged for overdue materials.

Reviser's note: The unnecessary underscoring in the above section occurred in the copy filed by the agency and appears in the Register pursuant to the requirements of RCW 34.08.040.

**WSR 92-15-067**  
**PROPOSED RULES**  
**BELLEVUE COMMUNITY COLLEGE**  
[Filed July 14, 1992, 2:00 p.m.]

Original Notice.  
Title of Rule: Chapter 132H-131 WAC, Scholarships and financial aid.  
Purpose: New chapter.  
Statutory Authority for Adoption: Chapter 34.05 RCW.  
Statute Being Implemented: RCW 28B.50.140.

Summary: Adds new chapter.

Reasons Supporting Proposal: Necessary for the preservation of general welfare as current practices are inconsistent with WAC as filed.

Name of Agency Personnel Responsible for Drafting: Phyllis C. Hudson, A201, (206) 641-2302; Implementation and Enforcement: Board of Trustees, A201, (206) 641-2302.

Rule is not necessitated by federal law, federal or state court decision.

Explanation of Rule, its Purpose, and Anticipated Effects: Provides current policies and regulations for students attending Bellevue Community College.

Proposal does not change existing rules.

No small business economic impact statement is required for this proposal by chapter 19.85 RCW.

Hearing Location: Bellevue Community College, 3000 Landerholm Circle S.E., B202A, Bellevue, WA 98007-6484, on September 1, 1992, at 8:00 a.m.

Submit Written Comments to: Phyllis C. Hudson, by August 27, 1992.

Date of Intended Adoption: September 8, 1992.

July 10, 1992  
Phyllis C. Hudson  
Secretary  
Board of Trustees

**CHAPTER 132H-131 WAC**  
**SCHOLARSHIPS AND FINANCIAL AID**

WAC

- 132H-131-010 Scholarships
- 132H-131-020 Financial Aid

NEW SECTION

WAC 132H-131-010 SCHOLARSHIPS. Detailed information concerning the criteria, eligibility, procedures for application and other information regarding scholarships may be obtained at the following address: Bellevue Community College, Attention: Scholarships, 3000 Landerholm Circle S.E., Bellevue, WA 98007-6484.

NEW SECTION

WAC 132H-131-020 FINANCIAL AID. Federal, state and private financial aid applications and information may be obtained at the following address: Bellevue Community College, Attention: Financial Services Office, 3000 Landerholm Circle S.E., Bellevue, WA 98007-6484.

Award of federal and state aid will be made in accordance with applicable federal and state laws and regulations.

**WSR 92-15-068**  
**PROPOSED RULES**  
**BELLEVUE COMMUNITY COLLEGE**  
[Filed July 14, 1992, 2:08 p.m.]

Original Notice.  
Title of Rule: Chapter 132H-122 WAC, Withholding services for outstanding debts.  
Purpose: New chapter.  
Statutory Authority for Adoption: Chapter 34.05 RCW.  
Statute Being Implemented: RCW 28B.50.140.  
Summary: Adds new chapter.

**Reasons Supporting Proposal:** Necessary for the preservation of general welfare as current practices are inconsistent with WAC as filed.

**Name of Agency Personnel Responsible for Drafting:** Phyllis C. Hudson, A201, (206) 641-2302; **Implementation and Enforcement:** Board of Trustees, A201, (206) 641-2302.

Rule is not necessitated by federal law, federal or state court decision.

**Explanation of Rule, its Purpose, and Anticipated Effects:** Provides current policies and regulations for students attending Bellevue Community College.

Proposal does not change existing rules.

No small business economic impact statement is required for this proposal by chapter 19.85 RCW.

**Hearing Location:** Bellevue Community College, 3000 Landerholm Circle S.E., B202A, Bellevue, WA 98007-6484, on September 1, 1992, at 8:00 a.m.

**Submit Written Comments to:** Phyllis C. Hudson, by August 27, 1992.

**Date of Intended Adoption:** September 8, 1992.

July 10, 1992  
Phyllis C. Hudson  
Secretary  
Board of Trustees

**CHAPTER 132H-122 WAC  
WITHHOLDING SERVICES FOR OUTSTANDING DEBTS**

**WAC**

- 132H-122-010 Statement of Policy
- 132H-122-020 Withholding services for outstanding debts.
- 132H-122-030 Appeal of initial order upholding the withholding of services for outstanding debts.

**NEW SECTION**

**WAC 132H-122-010 STATEMENT OF POLICY.** The college expects that students who receive services for which a financial obligation is incurred will exercise responsibility in meeting these obligations. Appropriate college staff are empowered to act in accordance with regularly adopted procedures to carry out the intent of this policy, and if necessary to initiate legal action to insure that collection matters are brought to a timely and satisfactory conclusion.

Admission to or registration with the college, conferring of degrees and issuance of academic transcripts may be withheld for failure to meet financial obligations to the college.

**NEW SECTION**

**WAC 132H-122-020 WITHHOLDING SERVICES FOR OUTSTANDING DEBTS.** (1) Upon receipt of a request for services where there is an outstanding debt owed to the college from the requesting person, the college shall notify the person, in writing by certified mail to the last known address, that the services will not be provided since there is an outstanding debt, and further that until that debt is satisfied, no such services will be provided to the individual.

(a) The notice shall include a statement to inform the college that he or she has a right to a hearing before a person designated by the president of the college if he or she believes that no debt is owed. The notice shall state that the request for the hearing must be made within twenty-one days from the date of notification.

(2) Upon receipt of a timely request for a hearing, the person designated by the president shall have the records and files of the college available for review and, at that time, shall hold a brief adjudicative proceeding concerning whether the individual owes or owed any outstanding debts to the institution. After the brief adjudicative proceeding, a decision shall be rendered by the president's designee indicating whether the college is correct in withholding services and/or applying off-set for the outstanding debt.

(a) If the outstanding debt is found to be owed by the individual involved, no further services shall be provided.

(b) Notice of the decision shall be sent to the individual within five days after the hearing.

**NEW SECTION**

**WAC 132H-122-030 APPEAL OF INITIAL ORDER UPHOLDING THE WITHHOLDING OF SERVICES FOR OUTSTANDING DEBTS.** (1) Any person aggrieved by an order issued under 132H-122-020 may file an appeal with the president. The appeal must be in writing and must clearly state errors in fact or matters in extenuation or mitigation which justify the appeal.

(2) The appeal must be filed within twenty-one days from the date on which the appellant received notification of the order issued under WAC 132H-122-020 upholding the withholding of services for outstanding debts. The president's determination shall be final.

**WSR 92-15-069  
PERMANENT RULES  
DEPARTMENT OF HEALTH  
(Board of Pharmacy)**

[Order 289B—Filed July 14, 1992, 2:55 p.m.]

**Date of Adoption:** June 11, 1992.

**Purpose:** To regulate the practice of wholesalers in compliance with Prescription Drug Marketing Act of 1987.

**Citation of Existing Rules Affected by this Order:** Amending WAC 246-879-010, 246-879-020, 246-879-030, 246-879-040, 246-879-050, 246-879-060, 246-879-070, and 246-879-080.

**Statutory Authority for Adoption:** RCW 18.64.005.

Pursuant to notice filed as WSR 92-10-070 on May 6, 1992.

**Changes Other than Editing from Proposed to Adopted Version:** Language added clarifying intent that pharmacists compounding drugs is allowed, adding security sections and allowing for reciprocity for distributors licensed in another state.

**Effective Date of Rule:** Thirty-one days after filing.

July 13, 1992  
Donald H. Williams  
Executive Director

**AMENDATORY SECTION** (Amending Order 191B, filed 8/30/91, effective 9/30/91)

**WAC 246-879-010 DEFINITIONS.** (1) "Full line wholesaler" means any wholesaler authorized by the board to possess and sell legend drugs, controlled substances (additional registration required see WAC 246-879-080) and nonprescription drugs (over-the-counter - OTC see WAC 246-879-070) to a licensed pharmacy or other legally licensed or authorized person.

(2) "Over-the-counter only wholesaler" means any wholesaler authorized by the board to possess and sell nonprescription (OTC) drugs to any outlets licensed for resale.

(3) "Controlled substances wholesaler" means a licensed wholesaler authorized by the board to possess and sell controlled substances to a licensed pharmacy or other legally licensed or authorized person.

(4) "Export wholesaler" means any wholesaler authorized by the board to export legend drugs and nonprescription (OTC) drugs to foreign countries.

(5) "Blood" means whole blood collected from a single donor and processed either for transfusion or further manufacturing.

(6) "Blood component" means that part of the blood separated by physical or mechanical means.

(7) "Drug sample" means a unit of prescription drug that is not intended to be sold and is intended to promote the sale of the drug.

(8) "Manufacturer" means anyone who is engaged in manufacturing, preparing, propagating, compounding, processing, packaging, repackaging, or labeling of a drug, provided that a pharmacist compounding drugs to be dispensed from the pharmacy in which the drugs are compounded pursuant to prescriptions for individual patients shall not be considered a manufacturer.

(9) "Prescription drug" means any drug required by state or federal law or regulation to be dispensed only by a prescription, including finished dosage forms and active ingredients subject to section 503(b) of the Federal Food, Drug, and Cosmetic Act.

(10) "Wholesale distribution" means distribution of prescription drugs to persons other than a consumer or patient, but does not include:

(a) The sale, purchase, or trade of a drug, an offer to sell, purchase or trade a drug, or the dispensing of a drug pursuant to a prescription;

(b) The lawful distribution of drug samples by manufacturers' representatives or distributors' representatives; or

(c) The sale, purchase, or trade of blood and blood components intended for transfusion.

(d) Intracompany sales, being defined as any transaction or transfer between any division, subsidiary, parent and/or affiliated or related company under the common ownership and control of a corporate entity, unless such transfer occurs between a wholesale distributor and a health care entity or practitioner.

(e) The sale, purchase, or trade of a drug or an offer to sell, purchase, or trade a drug for emergency medical reasons; for purposes of this section, "emergency medical reasons" includes transfers of prescription drugs by retail pharmacy to another retail pharmacy or practitioner to alleviate a temporary shortage, except that the gross dollar value of such transfers shall not exceed five percent of the total prescription drug sale revenue of either the transferor or transferee pharmacy during any twelve consecutive month period.

(11) "Wholesale distributor" means anyone engaged in wholesale distribution of drugs, including but not limited to, manufacturers; repackers; own-label distributors; private-label distributors; jobbers; brokers; warehouses; including manufacturers' and distributors' warehouses, chain drug warehouses, and wholesale drug warehouses; independent wholesale drug traders; and retail pharmacies that conduct wholesale distributions.

AMENDATORY SECTION (Amending Order 191B, filed 8/30/91, effective 9/30/91)

WAC 246-879-020 MINIMUM STANDARDS FOR WHOLESALERS. ((The following minimum standards shall apply to all wholesale outlets for which licenses have been issued by the board:

(1) Light and ventilation. All wholesale outlets including all storage areas, shall be well lighted, well ventilated and properly heated.

(2) Sanitary facilities. All wholesale outlets shall have sanitary facilities constructed in accordance with the laws and ordinances applying thereto. Facilities shall include a restroom for employees which shall be provided with a wash basin supplied with hot and cold running water and toilet.

(3) All drugs and chemicals shall be stored at appropriate temperatures according to label requirements to maintain stability.

(4) A residence shall not be considered to be an acceptable location for issuance of a wholesaler's license unless the wholesaler's business is operated in a separate space within the residence which otherwise meets the requirements of this section.

(5) Adequate space shall be provided consistent with the wholesale drug outlet operation.

(6) Minimum equipment shall be maintained consistent with the wholesale drug outlet's operation and shall be in proper working order at all times.

(7) Adequate security shall be provided as specified in WAC 360-21-050.

(8) Surrounding environmental conditions shall be adequate to prevent contamination of stored products:)) The following shall constitute minimum requirements for the storage and handling of prescription drugs, and for the establishment and maintenance of prescription drug distribution records by wholesale drug distributors and their officers, agents, representatives, and employees:

(1) Facilities. All facilities at which prescription drugs are stored, warehoused, handled, held, offered, marketed, or displayed shall:

(a) Be of suitable size and construction to facilitate cleaning, maintenance, and proper operations;

(b) Have storage areas designed to provide adequate lighting, ventilation, temperature, sanitation, humidity, space, equipment, and security conditions;

(c) Have a quarantine area for storage of prescription drugs that are outdated, damaged, deteriorated, misbranded, or adulterated, or that are in immediate or sealed, secondary containers that have been opened;

(d) Be maintained in a clean and orderly condition; and

(e) Be free from infestation by insects, rodents, birds, or vermin of any kind.

(2) Storage. All prescription drugs shall be stored at appropriate temperatures and under appropriate conditions in accordance with requirements, if any, in the labeling of such drugs or with the requirements in the 22nd edition of the United States Pharmacopeia/National Formulary (USP/NF). United States Pharmacopeia/National Formulary (USP/NF) is available for public inspection at the Office of the State Board of Pharmacy, 1300 Quince St SE, PO Box 47863, Olympia WA 98504-7863.

(a) If no storage requirements are established for a prescription drug, the drug may be held at "controlled" room temperature, as defined in an official compendium, to help ensure that its identity, strength, quality, and purity are not adversely affected.



(b) Appropriate manual, electromechanical, or electronic temperature and humidity recording equipment, devices, and/or logs shall be utilized to document proper storage of prescription drugs.

(3) Examination of materials.

(a) Upon receipt, each outside shipping container shall be visually examined for identity and to prevent the acceptance of contaminated prescription drugs or prescription drugs that are otherwise unfit for distribution. This examination shall be adequate to reveal container damage that would suggest possible contamination or other damage to contents.

(b) Each outgoing shipment shall be carefully inspected for identity of the prescription drug products and to ensure that there is no delivery of prescription drugs that have been damaged in storage or held under improper conditions.

(4) Returned, damaged, and outdated prescription drugs.

(a) Prescription drugs that are outdated, damaged, deteriorated, misbranded, or adulterated shall be quarantined and physically separated from other prescription drugs until they are destroyed or returned to their supplier.

(b) Any drug whose immediate or sealed outer or sealed secondary containers have been opened or used shall be identified as such, and shall be quarantined and physically separated from other drugs until they are either destroyed or returned to the supplier.

(c) If the conditions under which a drug has been returned cast doubt on the drug's safety, identity, strength, quality, or purity, then the drug shall be destroyed, or returned to the supplier, unless examination, testing, or other investigation proves that the drug meets appropriate standards of safety, identity, strength, quality, and purity. In determining whether the conditions under which a drug has been returned cast doubt on the drug's safety, identity, strength, quality, or purity, the wholesale drug distributor shall consider, among other things, the conditions under which the drug has been held, stored, or shipped before or during its return and the condition of the drug and its container, carton, or labeling, as a result of storage or shipping.

(5) Written policies and procedures. Wholesale drug distributors shall establish, maintain, and adhere to written policies and procedures, which shall be followed for the receipt, security, storage, inventory, and distribution of prescription drugs, including policies and procedures for identifying, recording, and reporting losses or thefts, and for correcting all errors and inaccuracies in inventories. Wholesale drug distributors shall include in their written policies:

(a) A procedure whereby the oldest approved stock of a drug product is distributed first. The procedure may permit deviation from this requirement if such deviation is temporary and appropriate.

(b) A procedure to be followed for handling recalls and withdrawals of prescription drugs. Such procedure shall be adequate to deal with recalls and withdrawals due to:

(i) Any action initiated at the request of the Food and Drug Administration or other federal, state, or local law

enforcement or other governmental agency, including the board of pharmacy;

(ii) Any voluntary action by the manufacturer to remove defective or potentially defective drugs from the market; or

(iii) Any action undertaken to promote public health and safety by replacing of existing merchandise with an improved product or new package design.

(c) A procedure to ensure that wholesale drug distributors prepare for, protect against, and handle any crisis that affects security or operation of any facility in the event of strike, fire, flood, or other natural disaster, or other situations of local, state, or national emergency.

(d) A procedure to ensure that any outdated drugs shall be segregated from other drugs and either returned to the manufacturer or destroyed. This procedure shall provide for written documentation of the disposition of outdated prescription drugs. This documentation shall be maintained for two years after disposition of the outdated drugs.

(6) Responsible persons. Wholesale drug distributors shall establish and maintain lists of officers, directors, managers, and other persons in charge of wholesale drug distribution, storage, and handling, including a description of their duties and a summary of their qualifications.

**AMENDATORY SECTION (Amending Order 191B, filed 8/30/91, effective 9/30/91)**

**WAC 246-879-030 INSPECTIONS.** (1) Inspections shall be performed by representatives of the board of pharmacy to ensure compliance with chapter ((360-24) 246-879 WAC. The following items shall be included in these inspections:

(a) ((The walls, ceilings, windows, and floors of the premises shall be clean and maintained in good repair and order.

(b) The licensee's premises shall be free from obnoxious odors.

(c) All persons working in premises are required to keep themselves and their apparel in a clean and sanitary condition.

(d) Other areas of inspection include, but are not limited to)) Housekeeping, sanitation, record keeping, accountability, security, types of outlets sold to and sources of drugs purchased.

(b) Wholesale drug distributors shall operate in compliance with applicable federal, state, and local laws and regulations.

(2) Wholesale drug distributors shall permit the board's authorized personnel and authorized federal, state, and local law enforcement officials to enter and inspect their premises and delivery vehicles, and to audit their records and written operating procedures, at reasonable times and in a reasonable manner, to the extent authorized by law. Such officials shall be required to show appropriate identification prior to being permitted access to wholesale drug distributors' premises and delivery vehicles.

AMENDATORY SECTION (Amending Order 191B, filed 8/30/91, effective 9/30/91)

~~WAC 246-879-040 RECORDS. ((Invoices shall be maintained for a period of five years, and show the source of supply for all drugs and to whom they were sold or distributed. Lack of such records shall be grounds for suspension or revocation of wholesale license. These records shall be available during regular business hours for inspection by any authorized representative of the board of pharmacy. In those instances in which records are stored in a location other than the wholesaler's premises, the records must be available for inspection within 72 hours.))~~ (1) Recordkeeping. Wholesale drug distributors shall establish and maintain inventories and records of transactions regarding the receipt and distribution or other disposition of prescription drugs. These records shall include the following information:

- (a) The source of the drugs, including the name and principal address of the seller or transferor, and the address of the location from which the drugs were shipped;
  - (b) The identity and quantity of the drugs received and distributed or disposed of; and
  - (c) The dates of receipt and distribution or other disposition of the drugs.
- (2) Inventories and records shall be made available for inspection and photocopying by an authorized official of any governmental agency charged with enforcement of these rules for a period of two years following disposition of the drugs.
- (3) Records described in this section that are kept at the inspection site or that can be immediately retrieved by computer or other electronic means shall be readily available for authorized inspection during the retention period. Records kept at a central location apart from the inspection site and not electronically retrievable shall be made available for inspection within two working days of a request by an authorized official of any governmental agency charged with enforcement of these rules.

AMENDATORY SECTION (Amending Order 191B, filed 8/30/91, effective 9/30/91)

~~WAC 246-879-050 SECURITY. (1) ((Every wholesaler shall take security precautions to ensure that access from outside the premises is reduced to a minimum and that internal security equipment (alarm systems) are used to detect entry after hours.))~~ All facilities shall be equipped with a security system that will provide suitable protection against theft and diversion. When appropriate, the security system shall provide protection against theft or diversion that is facilitated or hidden by tampering with computers or electronic records.

- (2) ((Legend)) Access from outside the premises shall be kept to a minimum and be well-controlled.
- (3) Entry into areas where prescription drugs are held shall be limited to authorized personnel.
- (4) All facilities used for wholesale drug distribution shall be secure from unauthorized entry.
- (5) Drug storage areas shall be constructed in such a manner as to prevent illegal entry.

~~((3))~~ (6) Adequate lighting shall be provided at the outside perimeter of the premises to reduce the possibility of illegal entry.

~~((4))~~ (7) All applicants for a license as a controlled substances wholesaler must comply with the security requirements as found in 21 CFR 1301.02, 1301.71 through 1301.74 and 1301.90 through 1301.92.

AMENDATORY SECTION (Amending Order 191B, filed 8/30/91, effective 9/30/91)

~~WAC 246-879-060 UNAUTHORIZED SALES. No wholesaler distributor shall sell or distribute any prescription drugs or devices except to an individual, corporation, or entity who is authorized by law or regulation to possess such drugs or devices. No wholesaler shall sell any prescription drugs or devices to an ultimate consumer.~~

AMENDATORY SECTION (Amending Order 191B, filed 8/30/91, effective 9/30/91)

~~WAC 246-879-070 APPLICATION FOR FULL LINE WHOLESALER LICENSE AND OVER-THE-COUNTER ONLY WHOLESALER LICENSE. ((No person shall act as a wholesaler unless he/she has obtained a license from the board.))~~

- (1) All applications for licensure of a new or relocated wholesaler shall be accompanied by the required fee as set forth in chapter 246-907 WAC ((360-18-020)).
- (2) ((Applications shall specify the location of the wholesaler premises. When the applicant is not the owner of the business, the application shall indicate the owner and the applicant affiliation with the owner.))
  - (a) If the owner is a partnership or other multiple owner, the names of the partners or person holding the three largest interests shall be indicated on the application.
  - (b) If the owner is a corporation, the name filed shall be the same as filed with the secretary of state. The name of the corporation, and the names of the corporation officers shall be indicated on the application.

~~(3))~~ All license renewal applications shall be accompanied by the annual fee and contain the same information required in subsection ((2)) (5) of this ((rule)) section.

- ~~((4))~~ (3) A change of ownership or location requires a new license.
- ~~((5))~~ (4) The license is issued to a person or firm and is nontransferable. Additions or deletions of a partner/partners shall be considered as a change of ownership.
- ~~((6))~~ (5) The license fee cannot be prorated.
- (6) Every wholesale distributor, wherever located, who engages in wholesale distribution into, out of, or within this state must be licensed by the board in accordance with the laws and regulations of this state before engaging in wholesale distribution of prescription drugs.
  - (a) Minimum required information for licensure. The board requires the following from each wholesale drug distributor as part of the initial licensing procedure and as part of any renewal of such license.

(i) The name, full business address, and telephone number of the licensee;

(ii) All trade or business names used by the licensee;

(iii) Addresses, telephone numbers, and the names of contact persons for the facility used by the licensee for the storage, handling, and distribution of prescription drugs;

(iv) The type of ownership or operation (i.e., partnership, corporation, or sole proprietorship); and

(v) The name(s) of the owner and/or operator of the licensee, including:

(A) If a person, the name of the person;

(B) If a partnership, the name of each partner, and the name of the partnership;

(C) If a corporation, the name and title of each corporate officer and director, the corporate names, and the name of the state of incorporation, and the name of the parent company, if any;

(D) If a sole proprietorship, the full name of the sole proprietor and the name of the business entity.

(vi) When operations are conducted at more than one location by a single wholesale distributor, each such location shall be licensed by the board.

(vii) Change in any information required by this section shall be submitted to the board within thirty days after such change.

(b) Minimum qualifications. The board shall consider, at a minimum, the following factors in reviewing the qualifications of persons who engage in wholesale distribution of prescription drugs within the state:

(i) Any convictions of the applicant under any federal, state, or local laws relating to drug samples, wholesale, or retail drug distribution, or distribution of controlled substances;

(ii) Any felony convictions of the applicant under federal, state, or local laws;

(iii) The applicant's past experience in the manufacture or distribution of prescription drugs, including controlled substances;

(iv) Any false or fraudulent material furnished by the applicant in any application made in connection with drug manufacturing or distribution;

(v) Suspension or revocation by federal, state, or local government of any license currently or previously held by the applicant for the manufacture or distribution of any drugs, including controlled substances;

(vi) Compliance with licensing requirements under previously granted licenses, if any;

(vii) Compliance with requirements to maintain and/or make available to the board, federal, state, or local enforcement officials those records required to be maintained by wholesale drug distributors; and

(viii) Any other factors or qualifications the board considers relevant to and consistent with public health and safety.

(c) The board shall have the right to deny a license to an applicant if it determines that the granting of such a

license would not be in the public interest. Public interest considerations shall be based on factors and qualifications that are directly related to the protection of the public health and safety.

(d) Personnel. As a condition for receiving and retaining a wholesale drug distributor license, the licensee shall require each person employed in any prescription drug wholesale distribution activity to have education, training, and experience, or any combination thereof, sufficient for that person to perform the assigned functions in such a manner as to provide assurance that the drug product quality, safety and security will at all times be maintained as required by law.

AMENDATORY SECTION (Amending Order 191B, filed 8/30/91, effective 9/30/91)

WAC 246-879-080 APPLICATION FOR CONTROLLED SUBSTANCE WHOLESALER LICENSE. (~~No person shall act as a controlled substance wholesaler unless he/she has obtained a controlled substance wholesaler license from the board.~~) Wholesale drug distributors that deal in controlled substances shall register with the board and with the Drug Enforcement Administration (DEA), and shall comply with applicable state, local, and DEA regulations.

(1) He/she must be licensed as a full line wholesaler.

(2) He/she must meet all security requirements as set forth in WAC (~~(360-21-050(4))~~) 246-879-050.

(3) He/she must meet additional requirements for registration and fees as set forth in chapter 246-907 WAC (~~(360-36-010)~~).

#### NEW SECTION

WAC 246-879-100 SALVAGING AND REPROCESSING COMPANIES. Wholesale drug distributors shall be subject to the provisions of any applicable federal, state, or local laws or rules that relate to prescription drug product salvaging or reprocessing, including this chapter.

#### NEW SECTION

WAC 246-879-110 VIOLATIONS AND PENALTIES. The board shall have the authority to suspend or revoke any licenses granted under this chapter upon conviction of violations of the federal, state, or local drug laws or rules. Before any license may be suspended or revoked, a wholesale distributor shall have a right to prior notice and a hearing pursuant to the Administrative Procedure Act, chapter 34.05 RCW.

#### NEW SECTION

WAC 246-879-120 RECIPROCITY. A wholesale distributor licensed in another state may be licensed in this state upon submission of the fee required in chapter 246-907 WAC and submission of information compiled by the National Association of Boards of Pharmacy (NABP) Clearinghouse demonstrating that the license is not, and has not been, the subject of adverse license action.

**WSR 92-15-070**

**WITHDRAWAL OF PROPOSED RULES  
SECRETARY OF STATE  
(By the Code Reviser's Office)  
[Filed July 14, 1992, 3:22 p.m.]**

WAC 434-166-360, proposed by the Secretary of State in WSR 92-02-104, appearing in issue 92-02 of the State Register, which was distributed on January 15, 1992, is withdrawn by the code reviser's office under RCW 34.05.335(3), since the proposal was not adopted within the one hundred eighty day period allowed by the statute.

Kerry S. Radcliff, Editor  
Washington State Register

**WSR 92-15-071**

**PERMANENT RULES  
SUPERINTENDENT OF  
PUBLIC INSTRUCTION**

[Order 92-05—Filed July 14, 1992, 4:19 p.m.]

Date of Adoption: April 17, 1992.

Purpose: To establish procedures for granting waivers of program rules for programs for special needs students to districts implementing innovative practices.

Statutory Authority for Adoption: Chapter 28A.155 RCW.

Other Authority: Chapter 34.05 RCW.

Pursuant to notice filed as WSR 92-06-053 on February 28, 1992.

Changes Other than Editing from Proposed to Adopted Version: Added provisions for notification of parents of district requests for waivers.

Effective Date of Rule: Thirty-one days after filing.

July 14, 1992  
Judith A. Billings  
Superintendent of  
Public Instruction

**Chapter 392-175 WAC  
WAIVER OF REGULATIONS PERTAINING TO  
SPECIAL EDUCATION, CHAPTER 1, AND  
LEARNING ASSISTANCE PROGRAMS**

**NEW SECTION**

WAC 392-175-001 **AUTHORITY.** The authority for this chapter is RCW 28A.155.090(7) which authorizes the superintendent of public instruction to promulgate rules and regulations to implement chapter 28A.155 RCW. Such authority is supplemented by RCW 28A.300.070 which authorizes the superintendent of public instruction to receive federal funds in accordance with the provisions of federal law. Inherent in the authority granted by RCW 28A.155.090(7), is the authority to waive, pursuant to chapter 34.05 RCW, any rule or regulation promulgated by the superintendent of public instruction.

**NEW SECTION**

WAC 392-175-005 **PURPOSE.** The purpose of this section is to establish procedures for the waiver of rules and regulations promulgated to govern special education, Chapter 1, and learning assistance programs to the extent requested by local school districts to provide improved programs for educationally at-risk students.

**NEW SECTION**

WAC 392-175-010 **STANDARDS FOR THE MODIFICATION OR WAIVER OF THE SUPERINTENDENT OF PUBLIC INSTRUCTION'S RULES.** The superintendent of public instruction shall grant a request of the modification or waiver of a special education, Chapter 1, or learning assistance program rule which the superintendent determines meets each of the following standards:

(1) The rule does not deal with public health, safety, or civil rights.

(2) The school district has presented satisfactory reasons for the modification or waiver of the rule.

(3) The rule is not required by federal statute or regulation which has not been waived by the United States Department of Education.

**NEW SECTION**

WAC 392-175-015 **WAIVER OF STATE STATUTES.** Statutory provisions that correspond to state administrative rule provisions which are modified or waived at the request of a school district pursuant to this chapter shall also be deemed to have been modified or waived to the same extent.

**NEW SECTION**

WAC 392-175-025 **RULES WAIVER PROCEDURES.** Any local school district, governed by the regulations in this chapter, may request from the superintendent of public instruction, waiver of any regulation governed by this chapter. Such request for waiver will be transmitted to the superintendent of public instruction in writing and shall clearly state the regulation to be waived, and, as appropriate, the duration of the waiver, the section or sections of the district's educational program to be covered by the waiver, and anticipated effect of the waiver on the district's operations. The district's application for waiver must demonstrate the method the district has employed to seek public input from parents and families regarding the development of the program innovation.

The superintendent shall respond in writing to the applicant district, granting or denying the waiver, and, if denying the waiver, reasons for such denial. If granted, the waiver shall state the duration of the waiver, and any limitations on the extent of the waiver. Should the superintendent's denial of a waiver be based on federal or other state agency regulations, the superintendent may request clarification of the intent of federal or other state agency regulations from the promulgating agency.

The superintendent shall design a system of evaluation of the effect of the waiver on the school district's educational program, including a system of review of the appropriateness of the waiver by other districts and families, students, teachers, and administrators, program evaluation, and a schedule for review of the appropriateness of the waiver. Each district receiving a waiver from these regulations shall be subject to any program review requirements which pertain to the programs subject to regulations being waived.

Should any waiver granted by the superintendent of public instruction be determined to be in conflict with federal or state statute or regulation, the superintendent shall give immediate notice to the district of revocation or revision of the waiver.

**WSR 92-15-072**  
**NOTICE OF PUBLIC MEETINGS**  
**LEGAL FOUNDATION**  
**OF WASHINGTON**  
 [Memorandum—July 13, 1992]

An additional meeting of the board of trustees for the Legal Foundation of Washington has been scheduled in August. The time and location of meetings remaining for the year is given below:

- August 14, 1992      Seattle  
 9:00 a.m.          Bogle and Gates Floor 51  
                          Two Union Square  
                          Sixth and Union
- September 25, 1992 Seattle  
 9:00 a.m.          Bogle and Gates Floor 51  
                          Two Union Square  
                          Sixth and Union
- November 6, 1992   Seattle  
 9:00 a.m.          Bogle and Gates Floor 51  
                          Two Union Square  
                          Sixth and Union
- December 4, 1992   Seattle  
 10:30 a.m.         Bogle and Gates Floor 51  
                          Two Union Square  
                          Sixth and Union

**WSR 92-15-073**  
**PROPOSED RULES**  
**BELLEVUE COMMUNITY COLLEGE**  
 [Filed July 15, 1992, 9:34 a.m.]

Original Notice.  
 Title of Rule: Chapter 132H-132 WAC, Bellevue Community College calendar.  
 Purpose: Amends WAC 132H-132-020.  
 Statutory Authority for Adoption: Chapter 34.05 RCW.  
 Statute Being Implemented: RCW 28B.50.140.  
 Summary: Amends WAC 132H-132-020.

Reasons Supporting Proposal: Necessary for the preservation of general welfare as current practices are inconsistent with WAC as filed.

Name of Agency Personnel Responsible for Drafting: Phyllis C. Hudson, A201, (206) 641-2302; Implementation and Enforcement: Board of Trustees, A201, (206) 641-2302.

Rule is not necessitated by federal law, federal or state court decision.

Explanation of Rule, its Purpose, and Anticipated Effects: Provides current regulations for students attending Bellevue Community College.

Proposal Changes the Following Existing Rules: Existing rules are in conflict with current operating practices.

No small business economic impact statement is required for this proposal by chapter 19.85 RCW.

Hearing Location: Bellevue Community College, B202A, 3000 Landerholm Circle S.E., Bellevue, WA 98007-6484, on September 1, 1992, at 8:00 a.m.

Submit Written Comments to: Phyllis C. Hudson, by August 27, 1992.

Date of Intended Adoption: September 8, 1992.

July 13, 1992  
 Phyllis C. Hudson  
 Secretary  
 Board of Trustees

AMENDATORY SECTION (Amending Order 17, filed 9/11/73)

WAC 132H-132-020 BELLEVUE COMMUNITY COLLEGE CALENDAR. (1) The college calendar for the subsequent year or years will be approved annually by the board of trustees no later than the March (~~at the regular December~~) board meeting. The calendar will specify both holidays and the instructional days for each of the ~~((four))~~ quarters for the ensuing year or years (~~and will include holidays~~).

(2) The college calendar for the following year or years will be published (~~in the annual catalog~~) annually by the President's Office immediately following board approval.

(3) The public can obtain specific calendar information (~~regarding the calendar~~) by contacting the college registration office.

**WSR 92-15-074**  
**PROPOSED RULES**  
**DEPARTMENT OF**  
**SOCIAL AND HEALTH SERVICES**  
**(Public Assistance)**

[Filed July 15, 1992, 11:50 a.m.]

Original Notice.

Title of Rule: WAC 388-24-250 Consolidated emergency assistance program—Conditions of eligibility.

Purpose: Changes the net income eligibility standard from fifty percent of need standard to ninety percent of the payment standard. RCW requires eligibility standards for CEAP be stricter than AFDC standards. In September 1992, the AFDC need standard will increase. Changing income eligibility makes administration of this mandate easier to manage.

Statutory Authority for Adoption: RCW 74.04.660.

Statute Being Implemented: RCW 74.04.660.

**Summary:** Will change the net income eligibility standard from fifty percent of the need standard to ninety percent of the payment standard.

**Reasons Supporting Proposal:** RCW requires that eligibility standards for CEAP be stricter than the standards for AFDC. In September 1992, AFDC need standard will increase. This WAC must be amended to prevent CEAP from becoming less strict than that for AFDC.

**Name of Agency Personnel Responsible for Drafting, Implementation and Enforcement:** RoseMary Micheli, Division of Income Assistance, 438-8318.

**Name of Proponent:** Department of Social and Health Services, governmental.

Rule is not necessitated by federal law, federal or state court decision.

**Explanation of Rule, its Purpose, and Anticipated Effects:** Same as above.

**Proposal Changes the Following Existing Rules:** See above.

No small business economic impact statement is required for this proposal by chapter 19.85 RCW.

**Hearing Location:** OB-2 Auditorium, 12th and Franklin, Olympia, Washington, on August 25, 1992, at 10:00 a.m.

**Submit Written Comments to:** Troyce Warner, Chief, Office of Issuances, Mailstop 5805, Department of Social and Health Services, Olympia, 98504, TELEFAX 664-0118 or SCAN 366-0118, by August 25, 1992.

**Date of Intended Adoption:** August 27, 1992.

July 15, 1992

Leslie F. James, Director  
Administrative Services

**AMENDATORY SECTION** (Amending Order 3359, filed 4/6/92, effective 5/7/92)

WAC 388-24-250 CONSOLIDATED EMERGENCY ASSISTANCE PROGRAM—CONDITIONS OF ELIGIBILITY. The department shall grant assistance under the consolidated emergency assistance program (CEAP) to families with dependent children or pregnant women meeting all of the following eligibility conditions:

(1) Have net monthly income less than ~~((fifty))~~ ninety percent of the ~~((need))~~ payment standard for AFDC households with shelter costs or, if income is above the ~~((fifty))~~ ninety percent cutoff, demonstrate that they could not have planned to avoid the emergency. The household shall demonstrate an inability to plan if funds ordinarily available were expended for:

- (a) Medical bills;
- (b) Emergent child care to avoid abuse;
- (c) Dental care to alleviate pain; or
- (d) Costs incurred in obtaining employment.
- (2) Are in financial need;
- (3) Are experiencing one or more of the following emergent needs:
  - (a) Food;
  - (b) Shelter;
  - (c) Clothing;
  - (d) Minor medical;
  - (e) Utilities;
  - (f) Household maintenance;
  - (g) Necessary clothing or transportation costs to accept or maintain a job; or

(h) Transportation for a minor, not in foster care, to a home where care will be provided by family members or approved caretakers.

(4) Are taking all steps necessary to make themselves eligible for, or are not under sanction for failure to comply with, the eligibility requirements of AFDC, SSI, GA-U, refugee assistance, medical assistance for CEAP applicants requesting emergent medical care, and food stamps for those CEAP applicants requesting emergent food assistance. If the crisis is not a result of the sanction and the family could

not have prevented the need for emergency assistance by compliance with eligibility requirements, the family may receive assistance if otherwise eligible;

(5) Are residents of Washington state. A resident is a person living in the state voluntarily with the intention of making and maintaining a home in the state and not for a temporary purpose or are:

(a) If not a resident, detained in Washington state for reasons beyond the household's control as a result of events which could not have been reasonably anticipated; or

(b) Migrants.

(6) Have not transferred property contrary to the requirements ~~((given in))~~ as described under WAC 388-28-457 through 388-28-465~~((:));~~;

(7) Have not refused a bona fide job offer or voluntarily terminated employment without good cause within thirty days before application or after application.

(a) Households refusing a bona fide offer of employment or ~~((voluntary))~~ voluntarily terminating employment without good cause within thirty days before application or after application shall be ineligible for thirty days or until the person accepts employment, whichever is less.

(b) The period of ineligibility shall begin on the date of refusal or termination of employment.

(c) The following conditions when verified shall constitute good cause for refusal or termination of employment:

(i) Physical, mental, or emotional inability of the person to satisfactorily perform the work required;

(ii) Inability of the person to get to and from the job without undue cost or hardship to the person, e.g., ~~((t))~~ travel time in excess of one hour, one way, is considered undue hardship~~((t))~~;

(iii) The nature of the work would be hazardous to the person;

(iv) The wages do not meet any applicable minimum wage requirements and are not customary for such work in the community;

(v) The job is available because of a labor dispute; or

(vi) Child care is not available to the household.

(8) Have applied for unemployment compensation if potentially eligible; and

(9) Are not aliens granted lawful temporary resident status under sections 245A and 210A of the Immigration and Nationality Act. Disqualification due to this provision applies for a period of five years from the date the temporary residence status was granted.

**Reviser's note:** The typographical error in the above section occurred in the copy filed by the agency and appears in the Register pursuant to the requirements of RCW 34.08.040.

**WSR 92-15-075**  
**NOTICE OF PUBLIC MEETINGS**  
**PIERCE COLLEGE**

[Memorandum—July 13, 1992]

The board of trustees of Community College District Number Eleven (Pierce College) would like to make the following change to an upcoming regular board meeting:

Meeting Date/Location	Time	Change to:
September 9, 1992 Ft. Steilacoom Campus	12:30	Change the meeting date to September 23, 1992 (Same time and location)

**WSR 92-15-076**  
**EMERGENCY RULES**  
**DEPARTMENT OF FISHERIES**

[Order 92-45—Filed July 15, 1992, 4:48 p.m.]

**Date of Adoption:** July 13, 1992.

**Purpose:** Personal use rules.

**Citation of Existing Rules Affected by this Order:**  
**Repealing WAC 220-24-02000L.**

**Statutory Authority for Adoption:** RCW 75.08.080.

Pursuant to RCW 34.05.350 the agency for good cause finds that immediate adoption, amendment, or repeal of a rule is necessary for the preservation of the public health, safety, or general welfare, and that observing the time requirements of notice and opportunity to comment upon adoption of a permanent rule would be contrary to the public interest.

Reasons for this Finding: This rule is adopted at the recommendation of the Pacific Fisheries Management Council and is intended to harvest available salmon, while providing protection for coho salmon through gear and landing limitations. The Columbia River mouth closed area protects milling salmon.

Effective Date of Rule: Immediately.

July 13, 1992  
Judith Merchant  
Deputy  
for Robert Turner  
Director

#### NEW SECTION

**WAC 220-24-02000M COMMERCIAL SALMON TROLL.** Notwithstanding the provisions of WAC 220-24-010, 220-24-020, or 220-24-030, effective immediately until further notice it is unlawful to fish for or possess salmon taken for commercial purposes with salmon troll gear from coastal waters west of the Bonilla-Tatoosh line, Pacific Ocean waters and waters west of the Buoy 10 line except as provided for in this section:

(1) Fishing is authorized from 12:01 a.m. July 20, 1992 to 11:59 p.m. July 21, 1992 in these waters except fishing is not allowed in Washington waters within Conservation Zone 1, described as those waters surrounding the mouth of the Columbia River inside a line projected six miles due west from North Head along 46°18'00" N. latitude to 124°13'18" W. longitude then southerly along a line of 167° true to 46°11'06" N. latitude and 124°11'00" (the Columbia River Buoy) then northeast along the red buoy line to the tip of the south jetty.

(2) All salmon taken in the fishery provided for herein must be sold by 12:01 a.m. July 22, 1992, and must be sold within the Salmon Management and Catch Reporting Area where taken or in an immediately adjacent Salmon Management and Catch Reporting Area.

(3) No vessel may land more than 30 coho salmon in the fishery provided for herein.

(4) Lawful terminal gear is restricted to four spreads per line and to plugs with a six-inch minimum size. A plug is defined as an artificial fish lure made of wood or hard plastic with one or more hooks attached. Plug length means the length of the wood or plastic portion of the lure, and is calculated independently of any hinge, attachment device or hook. Lures commonly known as "spoons," "wobblers," and "dodgers," and flexible plastic lures, including "hootchies," "skirts," and "curleytails" are not considered plugs, and may not be used. A plug may have a metal attachment affixed to the body of the plug to provide direction or stability, but may not have any metal attachment, such as a spoon, wobbler, or dodger, or any flexible plastic attachment, such as

hootchies, skirts or curleytails, that serves as an attractant.

(5) No chinook salmon smaller than 28 inches in total length nor coho salmon smaller than 16 inches in total length may be taken or retained in the fishery provided for herein.

(6) It is unlawful to fish for or possess salmon taken for commercial purposes with gear other than troll gear.

(7) It is unlawful to land salmon taken south of Cape Falcon in any port north of Cape Falcon, except when the waters north of Cape Falcon are closed. It is unlawful to land chinook taken south of Cape Falcon that are less than 26 inches in length.

#### REPEALER

The following section of the Washington Administrative Code is repealed:

WAC 220-24-02000L COMMERCIAL SALMON TROLL (92-22)

**WSR 92-15-077**  
**PERMANENT RULES**  
**OFFICE OF MINORITY**  
**AND WOMEN'S BUSINESS ENTERPRISES**

[Filed July 16, 1992, 11:12 a.m.]

Date of Adoption: July 16, 1992.

Purpose: These rules are updated to more effectively implement the provisions of chapter 39.19 RCW and to comply with the provisions of chapter 34.05 RCW.

Citation of Existing Rules Affected by this Order: Chapter 326-08 WAC.

Statutory Authority for Adoption: RCW 39.19.030(7).

Pursuant to notice filed as WSR 92-11-018 on May 12, 1992.

Effective Date of Rule: Thirty days after filing.

July 16, 1992  
James A. Medina  
Director

AMENDATORY SECTION (Amending Order 84-5, filed 4/5/84)

WAC 326-08-010 PURPOSE. The purpose of this chapter is to effectuate the intent of chapter 39.19 RCW by providing procedures for ~~((contested case hearings to review decisions of OMWBE to deny or to revoke certification or to refuse to renew certification of a business as an MBE or WBE))~~ adjudicative proceedings to review decisions by the office to decertify or deny certification of a business and for the assessment of penalties.

AMENDATORY SECTION (Amending Order 85-6, filed 7/2/85)

WAC 326-08-015 ~~((TIME FOR APPEAL))~~ PROCEDURE TO REQUEST AN ADJUDICATIVE PROCEEDING. ~~((When an applicant has been denied certification, or when a MWBE's certification has not been renewed or has been revoked, the aggrieved party~~

~~may request a hearing. The request must be made in writing and must be received by the office within thirty calendar days of the receipt of the decision denying certification, denying renewal of certification or revoking certification:))~~ (1) When business has been notified that it is to be decertified, denied certification, or assessed a penalty, the aggrieved party may request an adjudicative proceeding.

(2) The request shall be made in writing on 8 1/2" x 11" paper and shall set forth in detail the reasons the business believes the office's decision is in error.

(3) The request must be filed and served on the office within twenty calendar days from the service of the notice to decertify or deny certification, or assess penalties. Service must be made pursuant to WAC 326-08-070.

### NEW SECTION

WAC 326-08-016 ACTION ON REQUESTS FOR ADJUDICATIVE PROCEEDING. (1) The office shall commence an adjudicative proceeding within ninety days after receipt of a request for an adjudicative proceeding.

(2) An adjudicative proceeding commences when the office notifies a party that a prehearing conference, hearing, or other stage of an adjudicative proceeding will be conducted.

(3) Within thirty days after receipt of the request for an adjudicative proceeding, the office shall examine the request, notify the requestor of any obvious errors or omissions, request any additional information the office wishes to obtain and is permitted by law to require, and notify the requestor of the name, mailing address, and telephone number of the office that may be contacted regarding the request.

### NEW SECTION

WAC 326-08-018 PRESIDING OFFICER. The presiding officer in an adjudicative proceeding is the administrative law judge designated by the office of administrative hearings after notice of hearing is issued by the office.

AMENDATORY SECTION (Amending Order 84-5, filed 4/5/84)

WAC 326-08-020 GENERAL PROCEDURES RULES. The provisions of chapter 10-08 WAC, (~~"Uniform procedural rules for the conduct of contested cases"~~) "Model rules of procedure" shall apply to hearings regarding certification (~~(by OMWBE)~~) or penalties by the office.

### NEW SECTION

WAC 326-08-035 WHO MAY APPEAR. (1) Any party to an adjudicative proceeding may participate personally.

(2) The owner of the majority interest in a certified business is a necessary party and shall appear on behalf of the business.

(3) A former employee of the office shall not, at any time after severing his or her employment with the office, appear as a representative or expert witness on behalf of a petitioner in a matter in which he or she previously took an active part as a representative of the office, except with the written permission of the director.

AMENDATORY SECTION (Amending Order 84-5, filed 4/5/84)

WAC 326-08-040 WHO MAY APPEAR (~~AND PRACTICE~~) IN A REPRESENTATIVE CAPACITY. (~~No person other than the following may appear in a representative capacity governed by this chapter:)~~

(1) (~~Washington lawyer:)~~ Any party to an adjudicative proceeding may be represented or advised by:

(a) An attorney (~~(at law entitled)~~) admitted to practice before the Washington state supreme court (~~(of the state of Washington:)~~);

(~~(2)~~) (b) Other (~~(lawyer. An)~~) attorney (~~(at law entitled)~~) admitted to practice before the highest court (~~(of record)~~) of any other state, if attorneys (~~(at law of the state of)~~) from Washington state are permitted to appear in a representative capacity before administrative agencies of (~~(such other)~~) that state, and if not otherwise prohibited by Washington law;

(~~(3)~~) ~~Legal intern. A legal intern licensed to engage in the practice of law in the state of Washington under Admission to Practice Rule 9;~~

(4) ~~Officer, etc. A bona fide officer, partner, or full-time employee of an association, partnership, or corporation appearing for the association, partnership or corporation;~~

(~~5~~) ~~Former employee of OMWBE:)~~ (2) A former employee of (~~OMWBE shall not, at any time after severing his or her employment with the office, appear, except with the written permission of the director as a representative or expert witness on behalf of a petitioner in a matter in which he or she previously took an active part as a representative of)~~ the office may appear only as permitted in WAC 326-08-035(3).

AMENDATORY SECTION (Amending Order 84-5, filed 4/5/84)

WAC 326-08-050 NOTICE OF HEARING. (1) When (~~OMWBE~~) the director receives a request for (~~hearing:)~~ an adjudicative proceeding, the office will issue a notice (~~(of hearing will be issued)~~) to all parties and to the office of administrative hearings as provided by RCW (~~(34.04.090)~~) 34.05.434.

(~~(1)~~) (2) Time. All parties shall be served with notice not less than twenty days before the hearing.

(~~(2)~~) Contents. The notice shall state the time, place, and nature of the hearing. Further, it shall state the legal authority and jurisdiction under which the hearing is to be held, a reference to the particular statute and rules involved, and a short and plain statement of the matters asserted:) (3) The notice shall include:

(a) The names and mailing addresses of all parties to whom notice is being given and, if known, the names and addresses of their representatives;

(b) The name of the proceeding;



(c) The name, official title, mailing address, and telephone number of the presiding officer, if known;

(d) A statement of the time, place, and nature of the proceeding;

(e) A statement of the legal authority and jurisdiction under which the hearing is to be held;

(f) A reference to the particular sections of the statutes and rules involved;

(g) A short and plain statement of the matters asserted by the agency; and

(h) A statement that a party who fails to attend or participate in a hearing or other stage of an adjudicative proceeding may be held in default in accordance with WAC 326-08-105.

#### NEW SECTION

WAC 326-08-051 ACCOMMODATIONS. (1) If limited English-speaking or hearing impaired parties or witnesses will be involved in an adjudicative proceeding and need an interpreter, an interpreter will be provided at no cost to the party or witness.

(2) If disabled parties or witnesses will be involved in a hearing and need accommodation of facilities or services, the office will provide reasonable accommodation.

(3) Any party or witness requiring an interpreter or accommodation shall notify the office at the time of the request for an adjudicative proceeding.

AMENDATORY SECTION (Amending Order 84-5, filed 4/5/84)

WAC 326-08-070 SERVICE OF PAPERS. ~~((Any paper filed with the administrative law judge shall be served on all parties in the manner described in WAC 10-08-110.))~~ (1) All notices, pleadings, and other papers filed with the presiding officer shall be served upon all counsel and representatives of record and upon unrepresented parties or upon their agents designated by them or by law.

(2) Service shall be made personally or, unless otherwise provided by law, by first-class, registered, or certified mail; by telegraph, by electronic telefacsimile transmission and same-day mailing of copies, or by commercial parcel delivery company.

(3) Service by mail shall be regarded as completed upon deposit in the United States mail properly stamped and addressed. Service by telegraph shall be regarded as completed when deposited with a telegraph company properly addressed and with charges prepaid. Service by electronic telefacsimile transmission shall be regarded as completed upon production by the telefacsimile device of confirmation of transmission. Service by commercial parcel delivery shall be regarded as completed upon delivery to the parcel delivery company with charges prepaid.

(4) Papers required to be filed with the office shall be deemed filed upon actual receipt during office hours at any location of the office. Papers required to be filed with the presiding officer shall be deemed filed upon actual receipt during office hours at the office of the presiding officer.

(5) Where proof of service is required by statute or rule, filing the papers with the presiding officer, together with one of the following, shall constitute proof of service:

(a) An acknowledgement of service.

(b) A certificate that the person signing the certificate did on the date of the certificate serve the papers upon all parties of record in the proceeding by:

(i) Delivering a copy thereof in person to (names.); or

(ii) Mailing a copy thereof, properly addressed with postage prepaid, to each party to the proceeding or his or her attorney or authorized agent; or

(iii) Telegraphing a copy thereof, properly addressed with charges prepaid, to each party to the proceeding or his or her attorney or authorized agent; or

(iv) Transmitting a copy thereof by electronic telefacsimile device, and on the same day, mailing a copy to each party to the proceeding or his or her attorney or authorized agent; or

(v) Depositing a copy thereof, properly addressed with charges prepaid, with a commercial parcel delivery company.

AMENDATORY SECTION (Amending Order 84-5, filed 4/5/84)

WAC 326-08-080 WHO MAY ISSUE SUBPOENAS. Subpoenas may be issued by the director of ((~~OMWBE~~, any ~~OMWBE~~ staff member designated by the director)) the office, the director's designee, the assigned administrative law judge, or an attorney ((~~at law who is the attorney~~)) for any party in the ((~~contested case~~)) adjudicative proceeding as provided in RCW ((~~34.04.105~~)) 34.05.446.

AMENDATORY SECTION (Amending Order 84-5, filed 4/5/84)

WAC 326-08-090 SERVICE OF SUBPOENAS. Subpoenas may be served in any manner authorized by WAC ((~~10-08-110~~)) 326-08-070.

AMENDATORY SECTION (Amending Order 86-2, filed 8/11/86)

WAC 326-08-095 BURDEN OF PROOF AT A HEARING. (1) At a hearing held pursuant to WAC 326-08-010, the burden of proof shall be on the applicant to demonstrate ~~((why))~~ that the applicant qualifies for certification under chapter 39.19 RCW and Title 326 WAC.

(2) The administrative law judge ((~~may~~)) shall only admit and consider evidence on the issue of whether ((~~OMWBE's~~)) the office's decision to decertify or to deny ((~~revoke, or refuse to renew~~)) certification based on the information which was submitted or obtained by the office, was correct at the time it was made.

(3) The administrative law judge shall only admit and consider evidence related to the grounds specified in the request for an adjudicative proceeding.

AMENDATORY SECTION (Amending Order 84-5, filed 4/5/84)

WAC 326-08-100 PROCEDURES FOR SETTLEMENT OR DISPOSITION WITHOUT A HEARING. ~~((With the approval of the administrative law judge,))~~ (1) Disposition may ((also)) be made of any ((hearing)) adjudicative proceeding by stipulation, consent order ((or)), default. ~~((Any person feeling aggrieved by the entry of an order of default may request the director to review the order by using the procedure outlined in WAC 326-08-130. The director will set aside an order of default only upon a showing of good and sufficient cause for such failure to appear or to request a postponement prior to the scheduled time for hearing. In the event such order of default is set aside, all interested parties shall be so notified in writing and the matter restored to the hearing calendar)), or summary judgment.~~

(2) Summary judgment will be considered pursuant to a time schedule set by the administrative law judge and may be decided without oral argument.

NEW SECTION

WAC 326-08-105 DEFAULT. (1) If a party fails to attend or participate in a hearing or other stage of an adjudicative proceeding, the administrative law judge may serve upon all parties a default order with a statement of the grounds for the order.

(2) Within seven days after service of a default order under subsection (1) of this section, the party against whom the default order was entered may file a written motion to the administrative law judge requesting that the order be vacated and stating the grounds relied upon. The administrative law judge will set aside an order of default only upon a showing of good and sufficient cause for such failure to appear or to request a postponement prior to the scheduled time for hearing. In the event such order of default is set aside, all interested parties shall be so notified in writing and the matter restored to the hearing calendar.

AMENDATORY SECTION (Amending Order 84-5, filed 4/5/84)

WAC 326-08-110 ((PROPOSED DECISION—PREPARATION AND SERVICE)) INITIAL ORDER. (1) ((Preparation:)) Within ((a reasonable time)) ninety days after the conclusion of ((the hearing before an administrative law judge, the administrative law judge shall prepare a proposed order for signature by the director of OMWBE. The proposed order shall conform to the requirements of WAC 10-08-210:

(2) Service. A copy of the proposed order shall be sent, by certified mail, to all parties)) an adjudicative proceeding or after submission of memos, briefs, or proposed findings that the administrative law judge may allow after the adjudicative proceeding, the administrative law judge shall prepare an initial order for signature by the director.

(2) The initial order shall include a statement of findings and conclusions and the reasons and basis on all the material issues of fact, law, or discretion presented on

the record, including the remedy or sanction. Any findings based substantially on credibility of evidence or demeanor of witnesses shall be so identified. Findings set forth in language that is essentially a repetition or paraphrase of the relevant provision of law shall be accompanied by a concise and explicit statement of the underlying evidence of record to support the findings. The initial order shall also include a statement of the available procedures and time limits for seeking reconsideration or other administrative relief. An initial order shall include a statement of any circumstances under which the initial order, without further notice, may become a final order.

(3) Findings of fact shall be based exclusively on the evidence of record in the adjudicative proceeding and on matters officially noticed in that proceeding. Findings shall be based on the kind of evidence on which reasonably prudent persons are accustomed to rely in the conduct of their affairs. Findings may be based on such evidence even if it would be inadmissible in a civil trial. However, the administrative law judge shall not base a finding exclusively on such inadmissible evidence unless the administrative law judge determines that doing so would not unduly abridge the parties' opportunities to confront witnesses and rebut evidence. The basis for this determination shall appear in the order.

(4) Where it bears on the issues presented, the experience, technical competency, and specialized knowledge of the office may be used in the evaluation of evidence.

(5) If an administrative law judge becomes unavailable for any reason before the entry of the order, a substitute administrative law judge shall be appointed by the office of administrative hearings. The substitute administrative law judge shall use any existing record and may conduct any further proceedings appropriate in the interests of justice. Any action taken by a duly appointed administrative law judge for an unavailable administrative law judge is as effective as if taken by the unavailable administrative law judge.

(6) The administrative law judge shall cause to be served copies of the order on all parties.

AMENDATORY SECTION (Amending Order 84-5, filed 4/5/84)

WAC 326-08-120 OBJECTIONS TO ((PROPOSED DECISION)) INITIAL ORDER. ((Any party may make written objections to the proposed order. Any such objection must be served on the director and all other parties within ten days of service of the proposed order. An objection shall state specifically how the proposed order should be modified:)) (1) Any party to an adjudicative proceeding may file objections to an initial order pursuant to RCW 34.05.464.

(2) The objections to the initial order shall be filed with the director within twenty days of the date of service of the initial order. Copies of the objections to the initial order shall be served upon all other parties.

(3) The objections to the initial order shall specify the portions of the initial order to which objection is taken and shall refer to the evidence of the record which is relied upon to support each objection.

(4) Any party may file a reply to the objections to the initial order. The reply shall be filed with the director

within ten days of the date of service of the objections to the initial order and copies of the reply shall be served upon all other parties.

AMENDATORY SECTION (Amending Order 84-5, filed 4/5/84)

WAC 326-08-130 ((~~DECISION~~)) REVIEW OF INITIAL ORDER; FINAL ORDER. ((~~The director will issue a written decision no later than thirty days from the date the proposed decision is served on the parties.~~)) (1) An initial order will become final without further action by the office unless, within ninety days of the service of the initial order:

(a) The director determines that the initial order should be reviewed; or

(b) A party to the adjudicative proceeding files objections to the initial order as required in WAC 326-08-120(2).

(2) Upon the occurrence of either subsection (1)(a) or (b) of this section, the director will serve in writing a final order.

#### NEW SECTION

WAC 326-08-140 PETITION FOR RECONSIDERATION OF A FINAL ORDER. (1) Within ten days of the service of a final order or when an initial order becomes final, any party may file a petition for reconsideration, stating the specific grounds upon which relief is requested. The petition shall be filed with the office.

(2) No petition for reconsideration may stay the effectiveness of an order.

(3) If a petition for reconsideration is timely filed, the time for filing a petition for judicial review does not commence until the director disposes of the petition for reconsideration.

(4) The petition shall be disposed of by the same person or persons who entered the final order, if reasonably available. The disposition shall be in the form of a written order denying the petition, granting the petition and dissolving or modifying the final order, or granting the petition and remanding for further hearing by the administrative law judge.

(5) The director is deemed to have denied the petition for reconsideration, if, within twenty days from the date the petition is filed, the director does not either:

(a) Dispose of the petition; or

(b) Serve the parties with a written notice specifying the date by which it will act on the petition.

(6) The filing of a petition for reconsideration is not a prerequisite for seeking judicial review. An order denying reconsideration, or a notice provided for in subsection (5)(b) of this section is not subject to judicial review.

#### REPEALER

The following section of the Washington Administrative Code is repealed:

WAC 326-08-060 FORM OF PLEADINGS.

#### WSR 92-15-078

#### NOTICE OF PUBLIC MEETINGS LAW REVISION COMMISSION

[Memorandum—July 14, 1992]

Notice of rescheduled meetings of Washington State Law Revision Commission for 1992:

12:30 p.m.	Friday	September 25, 1992
12:30 p.m.	Friday	December 4, 1992

Both meetings will be held in Room 29, University of Washington School of Law, 1100 N.E. Campus Parkway, Seattle.

#### WSR 92-15-079

#### NOTICE OF PUBLIC MEETINGS HIGHLINE COMMUNITY COLLEGE

[Memorandum—July 14, 1992]

The following information regarding the regular monthly meetings of the Community College District 9 board of trustees for the period July 1992 through June 1993 is forwarded in compliance with RCW 42.30.075. All meetings begin at 8:00 a.m.

July 9, 1992  
No August meeting  
September 10, 1992  
October 8, 1992  
November 12, 1992  
December 10, 1992  
January 14, 1993  
February 11, 1993  
March 11, 1993  
April 8, 1993  
May 13, 1993  
June 10, 1993

#### WSR 92-15-080

#### PERMANENT RULES DAIRY PRODUCTS COMMISSION

[Filed July 16, 1992, 12:58 p.m., effective September 1, 1992]

Date of Adoption: July 15, 1992.

Purpose: Increase assessment from three-fourths of one cent per hundredweight to one cent per hundredweight.

Citation of Existing Rules Affected by this Order:  
Amending WAC 142-12-026.

Statutory Authority for Adoption: RCW 15.44.085.

Pursuant to notice filed as WSR 92-10-031 on April 30, 1992.

Effective Date of Rule: September 1, 1992.

July 15, 1992  
Liz Anderson  
Chairman

AMENDATORY SECTION (Amending Order 78-1, filed 10/16/78, effective 1/1/79)

WAC 142-12-026 ASSESSMENT RATE ON CLASS I AND CLASS II MILK. The assessment as set forth in RCW 15.44.085 which is levied on every hundredweight of Class I or Class II milk sold by a dealer, including any milk sold by a producer who acts as a dealer, is hereby increased from ~~((five-eighths))~~ ~~three-fourths~~ of one cent per hundredweight to ~~((three-fourths of))~~ one cent per hundredweight.

**WSR 92-15-081**  
**PERMANENT RULES**  
**LAKE WASHINGTON**  
**TECHNICAL COLLEGE**  
[Filed July 16, 1992, 1:11 p.m.]

Date of Adoption: July 8, 1992.

Purpose: To set forth policies governing College District 26 and Lake Washington Technical College.

Statutory Authority for Adoption: RCW 28B.50.140.

Pursuant to notice filed as WSR 92-12-049 on May 29, 1992.

Effective Date of Rule: Thirty-one days after filing.

July 8, 1992

Donald W. Fowler  
President

**Chapter 495D-104 WAC**  
**BOARD OF TRUSTEES**

NEW SECTION

WAC 495D-104-010 TIME AND PLACE OF BOARD MEETINGS. The board of trustees shall hold one regular meeting on the second Wednesday of each month at 7:30 am and such special meetings as may be requested by the chair of the board or by a majority of the members of the board and announced in accordance with law. All regular and special meetings of the board of trustees shall be held at Lake Washington Technical College, unless scheduled elsewhere, and are open to the general public, except for lawful executive sessions. No official business may be conducted by the board of trustees except during a regular or special meeting.

NEW SECTION

WAC 495D-104-020 REQUEST FOR ITEMS TO BE PLACED ON BOARD AGENDA. The president or his or her designee shall designate items for the board's meeting agenda, subject to modification by the board. Anyone other than a board member or a representative of the president's office wishing an item placed on the agenda of a board meeting must have a written request in the office of the board secretary at least two weeks in advance of the next scheduled meeting of the board. The board will adopt such bylaws as are necessary to facilitate the bringing of such matters before the board. Petitioners may request such bylaws from the secretary to the board who shall provide them in a timely fashion.

NEW SECTION

WAC 495D-104-030 DELEGATION TO COLLEGE PRESIDENT. The board of trustees delegates to the college president its authority and responsibility to administer College District 26 in accordance with laws, policies, and rules approved or sanctioned by the board of trustees. At the operational level, the president has final administrative authority over all matters affecting the college district.

**Chapter 495D-108 WAC**  
**PRACTICE AND PROCEDURE**

NEW SECTION

WAC 495D-108-010 ADOPTION OF MODEL RULES OF PROCEDURE. The model rules of procedure adopted by the chief administrative law judge pursuant to RCW 34.05.250 are adopted for use at this college. Those rules may be found in chapter 10-08 WAC. Other procedural rules adopted in this title are supplementary to the model rules of procedure. In the case of a conflict between the model rules of procedure and procedural rules adopted by this college, the college rules prevail.

NEW SECTION

WAC 495D-108-020 APPOINTMENT OF PRESIDING OFFICERS. The president or president's designee shall designate a presiding officer for an adjudicative proceeding. The presiding officer shall be an administrative law judge, a member in good standing of the Washington State Bar Association, a panel of individuals, the president or his or her designee, or any combination of the above. Where more than one individual is designated to be the presiding officer, the president or president's designee shall designate one person to make decisions concerning discovery, closure, means of recording adjudicative proceedings, and similar matters.

NEW SECTION

WAC 495D-108-030 METHOD OF RECORDING. Proceedings shall be recorded by a method determined by the presiding officer, among those available under the model rules of procedure.

NEW SECTION

WAC 495D-108-040 APPLICATION FOR ADJUDICATIVE PROCEEDING. An application for adjudicative proceeding shall be in writing. Application forms are available at the following address: Lake Washington Technical College, Affirmative Action Officer, 11605 132nd Avenue Northeast, Kirkland, Washington, 98034-5608.

Written application for an adjudicative proceeding must be submitted to the above address within twenty days of the agency action giving rise to the application, unless provided for otherwise by statute or rule.

NEW SECTION

WAC 495D-108-050 BRIEF ADJUDICATIVE PROCEDURES. This rule is adopted in accordance with RCW 34.05.482 through 34.05.494, the provisions of which are adopted by reference. Brief adjudicative procedures shall be used in all matters related to:

- (1) Residency determinations;
- (2) Challenges to contents of education records;
- (3) Student conduct proceedings, except as provided in another rule;
- (4) Parking and traffic violations;
- (5) Outstanding debts owed by students or employees;
- (6) Loss of eligibility for participation in college-sponsored activities;
- (7) Denials of requests for public records.

NEW SECTION

WAC 495D-108-060 DISCOVERY. Discovery in adjudicative proceedings may be permitted at the discretion of the presiding officer. In permitting discovery, the presiding officer shall refer to the civil rules of procedure. The presiding officer may control the frequency and nature of discovery permitted, and order discovery conferences to discuss discovery issues.

NEW SECTION

WAC 495D-108-070 PROCEDURE FOR CLOSING PARTS OF THE HEARINGS. Any party may apply for a protective order to close part of a hearing. The party making the request shall state the reasons for making the application to the presiding officer, and serve copies on all other parties. If another party opposes the request, a written response to the request shall be made within ten days of the request to the presiding officer. The presiding officer shall determine which, if any, parts of the proceeding shall be closed, and state the reasons in writing within twenty days of receiving the request.

NEW SECTION

WAC 495D-108-080 RECORDING DEVICES. No cameras or recording devices are allowed in those parts of proceedings that the presiding officer has determined shall be closed under WAC 495D-108-070, except for the method of official recording selected by the college.

Chapter 495D-116 WAC  
PARKING AND TRAFFIC

NEW SECTION

WAC 495D-116-010 PURPOSE FOR ADOPTING PARKING AND TRAFFIC RULES. Under the authority granted by RCW 28B.50.140(10), the board of trustees of College District 26 is granted authority to adopt rules for pedestrian and vehicular traffic upon public lands devoted to, operated by, or maintained by the college. The objectives of these rules are to:

- (1) Protect and control pedestrian and vehicular traffic;
- (2) Assure access at all times for emergency traffic;

- (3) Minimize traffic disturbances during class hours;
- (4) Facilitate the work of the college by assuring access to its vehicles and by assigning limited parking space for the most efficient use by all;
- (5) Regulate the use of parking spaces;
- (6) Protect state-owned property;
- (7) Assure access to the facility by handicapped persons.

NEW SECTION

WAC 495D-116-020 APPLICABLE PARKING AND TRAFFIC RULES. (1) All rules in this chapter and all motor vehicle and other traffic laws of the state of Washington apply on the campus.

(2) The traffic code of the city of Kirkland applies upon all lands located within the city of Kirkland.

(3) The traffic code of the city of Redmond applies upon all lands located within the city of Redmond.

NEW SECTION

WAC 495D-116-030 DEFINITIONS. The definitions set forth in this section apply throughout this chapter 495D-116 WAC.

(1) "Annual permits" mean permits that are valid from the date of issue until the first day of the following academic year.

(2) "Board" means the board of trustees of College District 26.

(3) "Campus" means all lands and buildings devoted to, operated by, or maintained by College District 26.

(4) "Campus security officer" means an employee of the college designated by and who is responsible to the vice-president of administration.

(5) "College" means Lake Washington Technical College.

(6) "Continuing permits" mean permits issued to full-time employees for an indefinite period of time.

(7) "Employee" means an individual appointed to the faculty, staff, or administration of the college.

(8) "Guests or visitors" mean persons who come upon the campus as guests or persons who lawfully visit the campus.

(9) "Safety and security supervisor" means the college's safety and security supervisor as designated by and responsible to the vice-president of administration.

(10) "Temporary permits" mean permits that are valid for a specific period designated on the permit.

(11) "Vehicle" means an automobile, truck, motor-driven cycle, scooter, or any vehicle powered by a motor.

NEW SECTION

WAC 495D-116-040 AUTHORIZATION FOR ISSUANCE OF PERMITS. (1) The safety and security supervisor or a designee may issue parking permits to students, employees, and guests upon the following condition:

(a) When the vehicle is properly registered with the college;

(b) When a permanent or special parking permit is necessary to enhance the business or operation of the college; and

(c) When a parking permit fee is paid as applicable and designated on the college's schedule of fees.

(2) Additional permits are available at the current fee schedule to individuals who may be registered to drive any one of several vehicles. Only one vehicle registered to an individual under one permit fee is permitted to park on campus at any one time.

NEW SECTION

WAC 495D-116-050 VEHICLE PARKING PERMITS. (1) All employees and students of the college shall obtain and display a currently valid parking permit on all vehicles parked or left standing unattended in parking areas which are posted as requiring permits.

(2) All persons parking in parking areas which are posted as requiring permits shall secure and display a currently valid parking permit upon approval of need for a special permit or within five days from their date of registration or from their first day of employment.

NEW SECTION

WAC 495D-116-060 VISITOR PERMITS. (1) All guests or visitors (including salespersons and maintenance or service personnel) will park in appropriate parking areas, and in parking areas requiring permits only after obtaining a temporary permit from the safety and security supervisor or a designee.

(2) Vehicle repair customers who have scheduled service or repairs with one of the motor vehicle technology courses operating an abatement program may obtain a twenty-four hour visitor permit a vehicle after repair or service.

NEW SECTION

WAC 495D-116-070 RESPONSIBILITY OF PERSON TO WHOM PERMIT IS ISSUED. The person to whom a parking permit is issued is responsible for all violations of college rules involving the vehicle; however, that responsibility does not relieve the driver of the responsibility for violations of the rules established by this chapter. If a vehicle in violation is not registered with the college, the current registered owner will be responsible for the violations of the campus rules.

NEW SECTION

WAC 495D-116-080 DISPLAY OF PERMITS. (1) An annual parking permit issued by the college pursuant to WAC 495D-116-040 through 495D-116-060 must be visibly affixed on the inside of the rear window of the vehicle for which the permit is issued, on the lower left-hand corner of the window as viewed from the rear of the vehicle. If the vehicle is a convertible or has no rear window, the annual permit must be affixed to the driver side rear bumper or driver side windshield lower corner. Motorcycle permits must be affixed in a conspicuous place.

(2) A temporary parking permit issued by the college pursuant to WAC 495D-116-040 through 495D-116-060 must be visibly placed on the inside of the rear window deck of the vehicle for which the permit is issued,

on the left-hand side of the window deck as viewed from the rear of the vehicle. If the vehicle has no window deck, the permit may be taped to the window. If the vehicle is a convertible or has no rear window, the temporary permit must be placed on the driver side of the instrument cowling. Motorcycle permits must be affixed in a conspicuous place.

NEW SECTION

WAC 495D-116-090 TRANSFER OF PERMITS. Parking permits are not transferable. If a vehicle is sold or traded, any replacement vehicle must be registered with the safety and security supervisor or designee and the permit will be reissued at no additional charge.

NEW SECTION

WAC 495D-116-100 PERMIT REVOCATION. Permits are licenses and are the property of the college, and may be revoked for any of the following reasons:

- (1) When the purpose for which the permit was issued changes or no longer exists;
- (2) When a permit is used on an unregistered vehicle or by an unauthorized person;
- (3) Falsification on a vehicle registration application;
- (4) More than two violations of parking and traffic rules;
- (5) Counterfeiting or altering of permits;
- (6) Commission of a theft or other crime in a vehicle parking area.

NEW SECTION

WAC 495D-116-110 RIGHT TO REFUSE PERMIT. The college vice-president of administration or a designee reserves the right to refuse the issuance of a parking permit to anyone who has had a previous permit revoked, or whose driving or parking record indicates a disregard for the rights or safety of others.

NEW SECTION

WAC 495D-116-120 APPEAL OF PERMIT REVOCATION OR REFUSAL. When a parking permit has been revoked under WAC 495D-116-100 or has been refused in accordance with WAC 495D-116-110 or when a fine or penalty has been levied for a purported violation of this chapter, that action by the vice-president of administration or a designee may be appealed in accordance with WAC 495D-116-180.

NEW SECTION

WAC 495D-116-130 DELEGATION OF AUTHORITY. The authority and powers conferred upon the vice-president of administration by this chapter are subject to delegation to that individual's subordinates.

NEW SECTION

WAC 495D-116-140 ENFORCEMENT. (1) Parking and traffic rules will be enforced at all times.

(2) The vice-president of administration or a designee is responsible for the enforcement of this chapter.

NEW SECTION

**WAC 495D-116-150 VIOLATION OF PARKING AND TRAFFIC RULES.** (1) Operators of illegally operated or parked vehicles shall be warned or cited through an appropriate written means that they are in violation of this chapter. All fines are payable at the cashier's office.

(2) In instances where a vehicle has more than two violations, the vice-president of administration or a designee, with appropriate documented evidence, may order the vehicle impounded.

NEW SECTION

**WAC 495D-116-160 ISSUANCE OF TRAFFIC TICKETS OR SUMMONS.** (1) The safety and security supervisor or a designee may issue a warning or citation for a violation of these regulations. The warning or citation must set forth the date, the approximate time, permit number if any, license information, and the nature of violation.

(2) The warning or citation may be served by attaching or affixing a copy in some prominent place outside the vehicle or by personally serving the operator.

NEW SECTION

**WAC 495D-116-170 FINES AND PENALTIES.** (1) The safety and security supervisor or a designee may impose fines and penalties for violation of this chapter: The vice-president of administration shall establish a schedule of fines. The college shall publish the current schedule annually in the schedule of courses and on the traffic parking citation form.

(2) Fines will be assessed in accordance with the schedule for the following violations:

- (a) No valid permit displayed;
- (b) Visitor parking violations;
- (c) Occupying more than one parking space;
- (d) Occupying a space or area not designated for parking;
- (e) Handicapped parking violation;
- (f) Parking in an area not authorized by a permit;
- (g) Parking in reserved staff space without authorization;
- (h) Blocking or obstructing traffic;
- (i) Parking adjacent to a fire hydrant;
- (j) Parking in a fire lane;
- (k) Parking in a zone or area marked no parking;
- (l) Other violations of college parking traffic rules.

(3) At the discretion of the vice-president of administration or a designee, an accumulation of citations by a staff, administrator, or faculty member may be turned over to a private collection agency for the collection of past due fines. Other appropriate collection procedures may be initiated as deemed necessary.

(4) If a student fails or refuses to pay an uncontested fine that has been outstanding in excess of five days, the vice-president of administration or a designee may initiate the following actions:

- (a) The student may be refused a transcript of credits, hours, or courses, a record of training, and other student records until all fines are paid;

(b) The student may not receive a certificate, diploma, or degree until all fines are paid;

(c) The student will not be able to register for subsequent terms until all fines are paid.

(d) The student's accumulation of fines may be turned over to a private collection agency for the collection of past due fines.

(5) Vehicles parking in a manner so as to create a safety hazard or obstruct traffic, including access to and from parking spaces and areas, may be subject to a fine and may be impounded and taken to a place for storage selected by the safety and security supervisor or a designee. The expenses of the impounding and storage are the responsibility of the registered owner or driver of the vehicle.

(6) Vehicles impounded by means of an immobilizing device shall be charged a service fee according to the current fee schedule.

(7) The college is not liable for loss or damage of any kind resulting from impounding and storage of vehicles.

(8) Persons may appeal the issuance of a citation according to WAC 495D-116-180.

NEW SECTION

**WAC 495D-116-180 APPEAL OF CITATIONS AND PENALTIES.** (1) Appeals must be made in writing, giving full particulars, including a list of witnesses and evidence expected to be presented, etc.

(2) Appeals must be submitted to the safety and security supervisor within five days from the date of citation. The appeal shall be handled as a brief adjudicative proceeding.

(3) The supervisor's decision shall be final unless an appeal is filed with the vice-president of administrative services within twenty-one days. Any decision of the vice-president shall be final.

NEW SECTION

**WAC 495D-116-200 DISCLAIMER OF LIABILITY BY COLLEGE.** The college assumes no liability under any circumstances for theft or damage occurring to vehicles, bicycles, or their contents. No bailment of any sort is created by the purchase or issuance of a parking permit.

NEW SECTION

**WAC 495D-116-210 DESIGNATION OF PARKING.** (1) The parking spaces available on campus may be allocated and designated by the vice-president of administration in such a manner as will best achieve the objectives of this chapter.

(2) Special provisions shall be made for physically disabled employees, visitors, students, or their designees. Physically disabled individuals using handicapped parking spaces must display in that vehicle a valid state-issued disabled parking permit or license plate. The safety and security supervisor shall issue temporary permits for temporarily handicapped persons. In addition to the disabled permit, valid college parking permits must be purchased and displayed on the vehicle in parking areas requiring permits.

(3) Spaces specifically designated as "visitor" are to be used only by visitors driving vehicles without continuing or annual permits, for a maximum time period of forty-eight hours. A temporary permit is not required. Visitors requiring parking for longer than forty-eight hours may obtain a temporary permit from the safety and security supervisor, and will park in normal undesignated spaces.

(4) The vice-president of administration may designate parking spaces for special purposes as deemed necessary.

#### NEW SECTION

WAC 495D-116-220 PARKING WITHIN DESIGNATED SPACES. (1) No vehicle may be parked on the campus except in those areas set aside and designated for parking.

(2) No vehicle may be parked so as to occupy any portion of more than one parking space or stall, except that a vehicle which is larger than one space may also occupy so much of an adjoining space(s) as is (are) necessary and as limited elsewhere in this chapter. Repeated parking on campus of oversize vehicles is discouraged in order to permit maximum utilization of limited parking spaces.

#### NEW SECTION

WAC 495D-116-230 REGULATORY SIGNS, MARKINGS, BARRICADES, ETC. The vice-president of administration or a designee may make and erect signs, barricades, and other structures and paint marks and other directions upon the streets, entrances, exits, and roadways for the regulation of traffic and parking upon the various public lands operated or maintained by the college. Drivers or vehicles shall observe and obey all the signs, barricades, structures, markings, and directions given them by the campus safety and security supervisor or designee in the control and regulation of traffic and parking.

#### NEW SECTION

WAC 495D-116-240 SPEED LIMIT. No vehicle may be operated on the campus at a speed in excess of the speed limit posted on campus property, or such slower speed as is reasonable and prudent to the circumstances.

#### NEW SECTION

WAC 495D-116-250 PEDESTRIAN RIGHT OF WAY. (1) The operator of a vehicle shall yield the right of way to any pedestrian. A pedestrian shall not leave a curb or other place of safety and walk or run into the path of an oncoming vehicle.

(2) When a sidewalk or crosswalk is provided, pedestrians shall proceed upon the sidewalk or crosswalk.

(3) Handicapped pedestrians using motorized or manually propelled wheelchairs or like equipment shall not be required to use curbs or sidewalks where there are none. Motor vehicle operators shall yield the right of way to wheelchair bound persons in any event.

#### NEW SECTION

WAC 495D-116-260 TWO-WHEELED MOTORCYCLES OR BICYCLES. (1) All two-wheeled vehicles powered by an engine shall park in areas designated for motorcycles only and will not use spaces assigned to automobiles or bicycles.

(2) Bicycles and other nonengine powered cycles must be parked in bicycle racks where provided. No person may park a bicycle inside a building or in such a manner as to block or obstruct the normal flow of pedestrian traffic.

#### NEW SECTION

WAC 495D-116-270 REPORT OF ACCIDENTS.

(1) The operator of a vehicle involved in an accident on campus resulting in injury or death of a person or claimed damage to either or both vehicles exceeding five hundred dollars shall immediately report the accident to the safety and security supervisor. Accidents occurring after the close of business must be reported the next working day. Within twenty-four hours after the accident, the operator shall file a state of Washington motor vehicle accident report.

(2) Other minor accidents may be reported to the safety and security supervisor for insurance record purposes.

#### NEW SECTION

WAC 495D-116-280 DISABLED OR INOPERATIVE VEHICLES—IMPOUNDING. (1) No vehicle shall be parked on the campus for a consecutive period exceeding seventy-two hours, without authorization from the vice-president of administration or a designee.

(2) Vehicles parked over seventy-two consecutive hours without authorization may be impounded and stored at the expense of either or both the owner and operator of the vehicle.

(3) Notice of intent to impound will be posted on the vehicle at least twenty-four hours before it will be impounded.

#### Chapter 495D-122 WAC WITHHOLDING SERVICES FOR OUTSTANDING DEBTS

#### NEW SECTION

WAC 495D-122-010 POLICY. If any person, including any faculty, staff, student, or former student, is indebted to the institution for an outstanding overdue debt, the college need not provide any further services of any kind to such individual, including but not limited to transmitting files, records, transcripts, or other services which have been requested by such person.

#### NEW SECTION

WAC 495D-122-020 NOTIFICATION. (1) Upon receiving a request for services where there is an outstanding debt due to the college from the requesting person, the college shall notify the person initially in person or by first-class mail that the services will not be



provided since there is an outstanding debt due. Any initial in-person notification should be followed by written notification by first class mail, except where the debt is cleared upon in-person notification. The person shall be told that until the debt is satisfied, requested services will not be provided.

(2) A letter of notification shall state that the person has a right to a brief adjudicative proceeding before a person designated by the president of the college. The proceeding must be requested within twenty days of the date of mailing notification of refusal to provide services.

#### NEW SECTION

**WAC 495D-122-030 PROCEDURE FOR BRIEF ADJUDICATIVE PROCEEDING.** (1) Upon receipt of a timely request for a hearing, the person designated by the president shall have the records and files of the college available for review and shall hold an informal hearing concerning whether the individual in fact owes any outstanding debts to the college. The hearing must be conducted within ten days of the request for a hearing.

(2) After the informal hearing, a decision shall be rendered by the president's designee indicating whether in fact the college is correct in withholding services for the outstanding debt. If the outstanding debt is owed by the individual involved, no further services shall be provided. Notification of this decision shall be sent to the individual within five days after the hearing.

(3) This hearing shall constitute a brief adjudicative proceeding established by the Administrative Procedure Act at RCW 34.05.482 through 34.05.494. The designee's decision shall be final unless the person within twenty-one days requests review by the president.

#### Chapter 495D-120 WAC STUDENT CONDUCT CODE

#### NEW SECTION

**WAC 495D-120-010 DEFINITIONS.** The definitions set forth in this section apply throughout this chapter.

(1) "Board" means the board of trustees of College District 26.

(2) "College" means Lake Washington Technical College.

(3) "Liquor" means the definition of liquor as contained within RCW 66.04.010.

(4) "Drugs" means a narcotic drug as defined in RCW 69.50.101, a controlled substance as defined in RCW 69.50.201 through 69.50.212, or a legend drug as defined in RCW 69.41.010.

(5) "College facilities" means the real property controlled or operated by the college and includes all buildings and appurtenances affixed thereon or attached thereto.

(6) "President" means the chief executive officer of the college appointed by the board of trustees.

(7) "Disciplinary official" means the instructor or administrator who takes disciplinary action as authorized in this chapter.

(8) "Student" means a person who is enrolled at the college.

(9) "Disciplinary action" means one or more of the actions described in WAC 495D-120-120.

#### NEW SECTION

**WAC 495D-120-020 STATEMENT OF PURPOSE.** (1) Lake Washington Technical College is maintained by the state of Washington for the provision of programs of instruction in higher education and related community services. Like any other institution having its own special purposes, the college must maintain conditions conducive to the effective performance of its functions. Consequently, it has special expectations regarding the conduct of the various participants in the college community.

(2) Admission to the college carries with it the prescription that the student will conduct himself or herself as a responsible member of the college community. This includes an expectation that the student will obey appropriate laws, will comply with the rules of the college and its departments, and will maintain a high standard of integrity and honesty.

(3) Sanctions for violations of college rules or conduct that interferes with the operation of college affairs will be dealt with by the college, and the college may impose sanctions independently of any action taken by civil or criminal authorities. In the case of minors, misconduct may be referred to parents or legal guardians.

#### NEW SECTION

**WAC 495D-120-030 JURISDICTION.** All rules in this chapter concerning student conduct and discipline apply to every student enrolled at the college whenever the student is engaged in or present at a college-related activity whether occurring on or off college facilities.

#### NEW SECTION

**WAC 495D-120-040 STUDENT MISCONDUCT.** Disciplinary action may be taken for a violation of any provision of this student code, for a violation of other college rules which may from time to time be properly adopted, or for any of the following types of misconduct:

(1) Smoking is prohibited in all enclosed college facilities and other areas so posted by college officials;

(2) The possession, use, sale, or distribution of any alcoholic beverage or illegal drug on the college campus is prohibited, except as specifically provided for by board policy. The use of illegal drugs by any student attending a college-sponsored event is also prohibited, even though the event does not take place at the college. The use of alcohol by any student attending such events on noncollege property shall conform to state law;

(3) Engaging in lewd, indecent, or obscene behavior;

(4) Where the student presents an imminent danger to college property or to himself or herself or other students or persons in college facilities on or off campus, or to the education process of the college;

(5) Academic dishonesty, including cheating, plagiarism, or knowingly furnishing false information to the college;

(6) The intentional making of false statements or filing of false charges against the college and members of the college community;

(7) Forgery, alteration, or misuse of college documents, records, funds, or instruments of identification with the intent to defraud;

(8) Theft from or damage to college premises or property, or theft of or damage to property of a member of the college community or college premises;

(9) Failure to comply with the direction of college officials acting in the legitimate performance of their duties;

(10) Possession of firearms, licensed or unlicensed, except where possessed by commissioned police officers as prescribed by law;

(11) Failure to comply with a college rule;

(12) Failure to comply with college attendance policy as published in the current edition of the Student Handbook;

(13) Retaliation upon witnesses or accusers under this chapter.

#### NEW SECTION

**WAC 495D-120-045 LOSS OF ELIGIBILITY—STUDENT ACTIVITY PARTICIPATION.** Any student found to have violated chapter 69.41 RCW, legend drugs, by virtue of a criminal conviction or by final decision of the college president shall, in lieu of or in addition to any other disciplinary action which may be imposed, be disqualified from participation in any school-sponsored student events or activities.

#### NEW SECTION

**WAC 495D-120-050 CIVIL DISTURBANCES.** In accordance with provisions contained in RCW 28B.10.571 and 28B.10.572:

(1) It shall be unlawful for any person, singly or in concert with others, to interfere by force or violence with any administrator, faculty member, or student of the college who is in the peaceful discharge or conduct of his or her duties or studies.

(2) It shall be unlawful for any person, singly or in concert with others, to intimidate by threat of force or violence any administrator, faculty member, or student of the college who is in the peaceful discharge of his or her duties or studies.

(3) The crimes described in RCW 28B.10.571 and 28B.10.572 shall not apply to any administrator or faculty member who is engaged in the reasonable exercise of their disciplinary authority.

(4) Any person or persons who violate the provisions of subsections (1) and (2) of this section will be subject to disciplinary action and referred to the authorities for prosecution.

#### NEW SECTION

**WAC 495D-120-060 FREE MOVEMENT ON CAMPUS.** The president or designee is authorized in

the instance of any event that he or she deems impedes the movement of persons or vehicles or which he or she deems to disrupt the ingress or egress of persons from the college facilities, to prohibit the entry of, or withdraw the license of, or privileges of a person or persons or any group of persons to enter onto or remain upon any portion of the college facility. The president may act through the vice-president administrative services or any other person he or she may designate.

#### NEW SECTION

**WAC 495D-120-070 RIGHT TO DEMAND IDENTIFICATION.** For the purpose of determining whether probable cause exists for the application of any section of this code to any behavior by any person on a college facility, any college personnel or other authorized personnel may demand that any person on college facilities produce evidence of student enrollment at the college by tender of that person's student identification card, registration schedule, and/or receipt for payment of fees for a current course.

#### NEW SECTION

**WAC 495D-120-080 ACADEMIC DISHONESTY/AND CLASSROOM/LAB/CLINIC CONDUCT.**

(1) Honest assessment of student performance is of crucial importance to all members of the academic community. Acts of dishonesty are serious breaches of honor and shall be dealt with in the following manner:

(a) It is the responsibility of the college administration and teaching faculty to provide reasonable and prudent security measures designed to minimize opportunities for acts of academic dishonesty which occur at the college.

(b) Any student who, for the purpose of fulfilling any assignment or task required by a faculty member as part of the student's program of instruction, shall knowingly tender any work product that the student fraudulently represents to the faculty member as the student's work product, shall be deemed to have committed an act of academic dishonesty. Acts of academic dishonesty shall be cause for disciplinary action.

(c) Any student who aids or abets the accomplishment of an act of academic dishonesty, as described in (b) of this subsection, shall be subject to disciplinary action.

(d) An instructor may adjust the student's grade on a particular project, paper, test, or class for academic dishonesty. This section shall not be construed as preventing an instructor from taking immediate disciplinary action when the instructor is required to act upon such breach of academic dishonesty in order to preserve order and prevent disruptive conduct in the classroom.

(2) Instructors have the authority to take whatever summary actions may be necessary to maintain order and proper conduct in the classroom and to maintain the effective cooperation of the class in fulfilling the objectives of the course.

(a) Any student who, by any act of misconduct, substantially disrupts any college class by engaging in conduct that renders it difficult or impossible to maintain

the decorum of the faculty member's class shall be subject to disciplinary action.

(b) The instructor of each course offered by the college is authorized to take such steps as may be necessary to preserve order and to maintain the effective cooperation of the class in fulfilling the objectives of the course; provided that; a student shall have the right to appeal such disciplinary action to the supervisor of the instructor imposing disciplinary action.

#### NEW SECTION

**WAC 495D-120-090 CAMPUS SPEAKERS.** (1) Student organizations officially recognized by the college may invite speakers to the campus to address their own membership and other interested students and faculty if suitable space is available and there is no interference with the regularly scheduled program of the college. Although properly allowed by the college, the appearance of such speakers on the campus implies neither approval nor disapproval of them or their viewpoints. In case of speakers who are candidates for political office, equal opportunities shall be available to opposing candidates if desired by them. Speakers are subject to the normal considerations for law and order and to the specific limitations imposed by the state constitution which prohibits religious worship, exercise or instruction on state property.

(2) In order to insure an atmosphere of open exchange and to insure that the educational objectives of the college are not obscured, the president or designee, in a case attended by strong emotional feeling, may prescribe conditions for the conduct of the meeting, such as requiring a designated member of the faculty as chair, or requiring permission for comments and questions from the floor. Likewise, the president or designee may encourage the appearance of one or more additional speakers at any meeting or at a subsequent meeting so that other points of view may be expressed. The president may designate representatives to recommend conditions such as time, manner, and place for the conduct of particular meetings.

#### NEW SECTION

**WAC 495D-120-100 DISTRIBUTION OF INFORMATION.** (1) Handbills, leaflets, newspapers, and similar materials may be sold or distributed free of charge by any student or students, or by members of recognized student organizations, or by college employees on or in college facilities at locations specifically designated by the appropriate administrator; provided such distribution or sale does not interfere with the ingress or egress of persons or interfere with the free flow of vehicular or pedestrian traffic.

(2) Such handbills, leaflets, newspapers, and related matter must bear identification as to the publishing agency and distributing organization or individual.

(3) All nonstudents shall register with the director of campus services prior to the distribution of any handbill, leaflet, newspaper, or related matter. Such distribution or sale must not interfere with the free flow of vehicular or pedestrian traffic.

(4) Any person or persons who violate provisions of subsections (1) and (2) of this section will be subject to disciplinary action.

#### NEW SECTION

**WAC 495D-120-110 COMMERCIAL ACTIVITIES.** (1) College facilities will not be used for a commercial solicitation, advertising, or promotional activities except when such activities:

(a) Clearly serve educational objectives, including but not limited to display of books of interest to the academic community or the display or demonstration of technical or research equipment; and

(b) Are conducted under the sponsorship or at the request of the college, or the office of the associated students of the college if such solicitation does not interfere with or operate to the detriment of the conduct of college affairs or the free flow of vehicular or pedestrian traffic.

(2) College facilities, equipment, and supplies may not be used by students for personal commercial gain.

(3) For the purpose of this regulation, the term "commercial activities" does not include handbills, leaflets, newspapers, and similarly related materials as regulated in WAC 495D-120-100.

#### NEW SECTION

**WAC 495D-120-120 DISCIPLINARY TERMS.** The definitions set forth in this section apply throughout this chapter.

(1) Verbal warning means oral notice of violation of college rules.

(2) A written warning is a reprimand which indicates to the student that continuation or repetition of the specific conduct involved or other misconduct will result in one or more serious disciplinary actions described below.

(3) Probation means formal action placing conditions upon the student's continued attendance because of violation of college rules or failure to satisfy the college's expectations regarding conduct. The disciplinary official placing the student on probation will specify, in writing, the period of probation and the conditions, such as not missing any class sessions or turning in on time all work assigned. Probation warns the student that any further misconduct will automatically raise the question of termination of enrollment at the college. Probation may be for a specified term or for an indefinite period which may extend to graduation or other termination of the student's enrollment in the college.

(4) Summary suspension means temporary dismissal from the college and temporary termination of a student's status for a period of time not to exceed ten days which occurs prior to invocation of the formal hearing procedures specified in these rules due to a necessity to take immediate disciplinary action, where a student presents an imminent danger to the college property, or to himself or herself or other students or persons in college facilities on or off campus, or to the educational process of the college.

(5) Suspension means dismissal from the college and termination of a student's status, other than a summary

suspension, for a specified period of time not exceeding one term.

(6) Termination means dismissal from the college and termination of student status for violation of college rules or for failure to meet the college standards of conduct for an indefinite period of time or permanently.

(7) Monetary fine or restitution: A written order, alone or combined with another disciplinary action, requiring the student to pay, within a stated time limit, appropriate restitution for a financial loss caused by the student's misconduct and/or monetary fine not exceeding one quarter's tuition. Failure to pay shall be cause for further disciplinary action and/or cancelling and barring the student's registration.

#### NEW SECTION

**WAC 495D-120-130 INITIATION OF DISCIPLINE.** (1) Any college instructor or administrator, except the president and the vice-president who would hear any appeal, may take any of the disciplinary actions defined in WAC 495D-120-120, except that only an administrator or vice-president may suspend or terminate a student from the college for more than ten days. Before taking the action, the disciplining official ordinarily should notify his/her supervisor and meet or attempt to meet with the student to explain the seriousness of the matter and hear any explanation by the student.

(2) The student should be given written notice of any disciplinary action except a verbal warning. Such written notice shall be either delivered personally or mailed by first-class mail to the student's last known address. The notice or warning should advise the student of his/her right to appeal under these rules.

#### NEW SECTION

**WAC 495D-120-140 APPEAL OF DISCIPLINARY ACTION.** (1) A student may appeal a disciplinary action by filing, within twenty days after the earlier of personal delivery or mailing of notice of the disciplinary action, a written application for a brief or formal adjudicative proceeding. This application may, but need not, explain the student's position and/or be on a form provided under WAC 495D-108-040. The application shall be filed with either the vice-president for instructional services or vice-president for administrative services, but should not be filed with a vice-president who has primary managerial responsibility for the disciplining official.

(2) The vice-president receiving the application for an adjudicative proceeding may refer it for initial review by a supervisor of the disciplining official within a time deadline not exceeding twenty days set by the vice-president. In that optional review, the supervisor should meet or attempt to meet with the student, the disciplining official, and anyone else deemed to have information necessary for the supervisor's review. The supervisor should file with the vice-president and serve on the student, within the established deadline, a written report.

(3) Unless the discipline is rescinded or the student confirms in writing his/her withdrawal of the application for an adjudication, the vice-president shall conduct an adjudicative proceeding, and shall be its presiding officer. This shall be a brief adjudicative proceeding unless:

(a) The vice-president decides to convert the case to a formal adjudicative hearing; or

(b) The discipline includes some form of dismissal from the college and the student in his/her request for an adjudication specified a formal adjudicative hearing.

(4) If for any reason the vice-president cannot serve as presiding officer, the president or president's designee shall designate the replacement presiding officer. Disqualification of a presiding officer shall be as provided in RCW 34.05.425.

(5) The matter shall be heard by the presiding officer de novo.

(6) Failure to participate or cooperate in the proceeding may be taken into consideration by the presiding officer and shall not preclude the presiding officer from making a decision. This shall not limit the possibility of a default under RCW 34.05.440.

(7) No attorney representative of any party may participate in a meeting or hearing unless he/she has filed with the presiding officer and served on all other parties, at least five days previously, a notice of appearance. In the event of such notice, any other party may also have counsel.

(8) The presiding officer may exclude from a meeting or hearing any person whose conduct is disruptive.

(9) The presiding officer and, subsequently, a reviewing officer, may affirm, modify, or reverse the disciplinary action.

#### NEW SECTION

**WAC 495D-120-150 DISCIPLINE—BRIEF ADJUDICATIVE PROCEEDINGS.** In a brief adjudicative proceeding:

(1) RCW 34.05.485 through 34.05.494 and WAC 10-08-080 shall govern, unless otherwise provided in these rules.

(2) The presiding officer shall serve on the parties and provide to the president an initial order, a brief written statement of the reasons for the decision, within ten days in accordance with RCW 34.05.485. That statement shall describe the available administrative review procedures specified in the following subparagraph.

(3) The initial order shall become the final order, without further action, unless within twenty-one days of service of the initial order:

(a) The president or president's designee, upon his/her own motion, determines that the initial order should be reviewed; or

(b) A party to the proceedings files with the president a written petition for administrative review of the initial order.

The president or president's designee shall be the reviewing officer and RCW 34.05.491 shall apply to any such determination or petition.

NEW SECTION

WAC 495D-120-160 DISCIPLINE REVIEW—FORMAL ADJUDICATIVE PROCEEDINGS. In a formal adjudicative proceeding:

(1) RCW 34.05.413 through 34.05.479 and chapters 10.08 and 495D-108 WAC shall govern, unless otherwise provided in these rules.

(2) The presiding officer may designate a recordkeeping clerk and/or other staff as appropriate. Hearings shall be recorded, in accordance with WAC 10-08-170. If any part of a hearing is closed in accordance with WAC 495D-108-070, the recording of that closed part shall be kept separate and confidential.

(3) The presiding officer may conduct prehearing conference(s) in accordance with RCW 34.05.431 and WAC 10-08-130.

(4) The presiding officer may permit or conduct discovery as provided in RCW 34.05.446, WAC 10-08-120, and 495D-108-060.

(5) The presiding officer shall give not less than seven days advance written notice of a hearing to all parties and all intervenors, except where such notice is waived, in accordance with RCW 34.05.434, WAC 10-08-040, or other applicable law.

(6) The burden of proof shall be on the party seeking to uphold the discipline to establish good cause by a preponderance of the evidence.

(7) Within the ninety days specified in RCW 34.05.461, and preferably within twenty days, the presiding officer shall serve on the parties and provide to the president an initial order, together with any relevant comments on the demeanor of witnesses. At the same time, a full and complete record of the proceedings shall also be transmitted to the president. The initial order shall include a statement of findings and conclusions and otherwise comply with RCW 34.05.461 and WAC 10-08-210. The initial order also shall describe the available administrative review procedures specified in the following subsection.

(8) The initial order shall become the final order, without further action, unless within twenty-one days of service of the initial order:

(a) The president or president's designee upon his/her own motion, determines that the initial order should be reviewed; or

(b) A party to the proceedings files with the president a written petition for administrative review of the initial order.

The president or president's designee shall be the reviewing officer and RCW 34.05.464 and WAC 10-08-211 shall apply to any such determination or petition.

NEW SECTION

WAC 495D-120-170 REFUNDS AND ACCESS.

(1) Refund of fees for the quarter in which disciplinary action is taken shall be in accordance with the college's refund policy.

(2) A student suspended on the basis of misconduct which disrupted the orderly operation of the campus or any facility of the district, may be denied access to all or any part of the campus or other facility.

NEW SECTION

WAC 495D-120-180 READMISSION AFTER SUSPENSION OR TERMINATION. Any student suspended from the college for disciplinary reasons will normally be readmitted upon expiration of the time period for which the suspension was issued. If the student has been terminated or feels that circumstances warrant reconsideration of a suspension prior to its expiration, or if the student was suspended with conditions imposed for readmission, the student may be readmitted following approval of a written petition submitted to the administrator who imposed such suspension or such other administrator as may be designated by the executive vice-president for instruction. Such petition must state reasons which support a reconsideration of the matter. Before readmission may be granted in any case, a petition must be submitted, reviewed by a conference between a counselor, instructor, and administrator, and approved by the administrator.

NEW SECTION

WAC 495D-120-190 REESTABLISHMENT OF ACADEMIC STANDING. Students who have been suspended or terminated pursuant to disciplinary procedures set forth in WAC 495D-120-120 and 495D-120-130 and whose suspension or termination upon appeal is found to have been unwarranted shall be provided the opportunity to reestablish their academic and student standing to the extent possible within the abilities of the college, including an opportunity to retake examinations or otherwise complete course offerings missed by reason of such action.

NEW SECTION

WAC 495D-120-200 REPORTING, RECORDING, AND MAINTAINING RECORDS. Records of all disciplinary cases shall be kept by the disciplinary official taking or initiating the action. Except in proceedings where the student is exonerated, all documentary or other physical evidence produced or considered in disciplinary proceedings and all recorded testimony shall be preserved, insofar as possible, for not less than six years. No other records of proceedings wherein the student is exonerated, other than the fact of exoneration, shall be maintained in the student's discipline file or other college repository.

Chapter 495D-130 WAC  
TUITION AND FEE SCHEDULES

NEW SECTION

WAC 495D-130-010 TUITION AND FEE SCHEDULES. Chapter 28B.15 RCW and RCW 28B.50.327 set the parameters for tuition and fee levels at state community and technical colleges. Based on this legislation, the specific amounts to be charged are recommended by the administration and adopted by the board of trustees of Lake Washington Technical College.

NEW SECTION

WAC 495D-130-015 TUITION AND FEE WAIVERS. Chapter 28B.15 RCW and RCW 28B.50.327 set the parameters for tuition and fee waivers at state community and technical colleges. Based on this legislation, the specific types of tuition and fee waivers are established by the administration and adopted by the board of trustees of Lake Washington Technical College.

NEW SECTION

WAC 495D-130-020 LOCATION OF SCHEDULES. Additional and detailed information and specific amounts to be charged for each category of students and courses will be found in the college catalog, schedule of courses, and in the following locations on the Lake Washington Technical College campus:

- (1) The office of admissions;
- (2) The registration office;
- (3) The office of the administrator of financial services;
- (4) The financial aid office; and
- (5) The college relations office.

Chapter 495D-131 WAC  
SCHOLARSHIPS

NEW SECTION

WAC 495D-131-010 SCHOLARSHIPS. Detailed information concerning the criteria, eligibility, procedures for application, and other information regarding scholarships at Lake Washington Technical College is located in the office of financial aid on the Lake Washington Technical College campus.

Chapter 495D-132 WAC  
FINANCIAL AID

NEW SECTION

WAC 495D-132-010 FINANCIAL AID. Federal, state, and private financial aid applications and information may be obtained at the following address:

Office of Financial Aid  
Lake Washington Technical College  
11605 132nd Avenue Northeast  
Kirkland, Washington 98034-5608

Award of federal and state aid will be made in accordance with applicable federal and state laws and regulations.

Chapter 495D-133 WAC  
ORGANIZATION

NEW SECTION

WAC 495D-133-020 ORGANIZATION—OPERATION—INFORMATION. (1) Organization. Lake Washington Technical College is established in Title 28B RCW as a public institution of higher education. The college is governed by a five-member board of

trustees, appointed by the governor. The board employs a president, who acts as the chief executive officer of the college. The president establishes the structure of the administration.

(2) Operation. The administrative office is located at the following address:

11605 132nd Avenue Northeast  
Kirkland, WA 98034-8506

The office hours are 7:30 a.m. to 4:30 p.m., Monday through Friday, except legal holidays. Educational operations are also located at the following address:

Marymoor Annex  
6505 176th Avenue Northeast  
Redmond, WA 98052-4943

(3) Information. Additional and detailed information concerning the educational offerings of the college may be obtained from the catalog, copies of which are available at the following address:

11605 132nd Avenue Northeast  
Kirkland, WA 98034-8506

Chapter 495D-134 WAC  
DESIGNATION OF RULES COORDINATOR

NEW SECTION

WAC 495D-134-010 RULES COORDINATOR. The rules coordinator for Lake Washington Technical College as designated by the president is:

Vice-President  
Administrative Services  
Lake Washington Technical College  
11605 132nd Avenue Northeast  
Kirkland, WA 98034-8506

Chapter 495D-140 WAC  
USE OF COLLEGE FACILITIES

NEW SECTION

WAC 495D-140-010 USE OF COLLEGE FACILITIES. Lake Washington Technical College serves King and Snohomish counties by providing continued educational opportunity for its citizens. In keeping with this general purpose, and consistent with RCW 28B.50.140(7) and 28B.50.140(9), the board of trustees believes that facilities should be available for a variety of uses which are of benefit to the general public if such general uses substantially relate to and do not interfere with the educational mission of the college. However, a state agency is under no obligation to make its public facilities available to the community for private purposes.

NEW SECTION

WAC 495D-140-020 LIMITATION OF USE TO SCHOOL ACTIVITIES. (1) When allocating use of college facilities, the highest priority is always given to activities specifically related to the college's mission. No arrangements will be made that may interfere with or

operate to the detriment of the college's own teaching or public service programs. In particular, college buildings, properties, and facilities, including those assigned to student programs, are used primarily for:

(a) The regularly established teaching or public service activities of the college and its departments;

(b) Training, educational, cultural, or recreational activities of the students, faculty, or staff;

(c) Short courses, inservices, seminars, or similar events, conducted either in the public service or for the advancement of specific college interests, when arranged under the sponsorship of the college;

(d) Public events of a professional or cultural nature brought to the campus at the request of college departments or committees and presented with their active sponsorship and active participation;

(e) Activities or programs sponsored by educational institutions, by state or federal agencies, by charitable agencies or civic or community organizations whose activities are of widespread public service and of a character appropriate to the college.

(2) College facilities may be used by student organizations for regular business meetings, social functions, and for programs open to the public. Any recognized campus student organization may invite speakers from outside the college community. The appearance of an invited speaker on campus does not represent an endorsement by the college, its students, faculty, administration, or the board of trustees, implicitly or explicitly, of the speaker's views.

(3) Reasonable conditions may be imposed to regulate the timeliness of requests, to determine the appropriateness of space assigned, time of use, and to insure the proper maintenance of the facilities. Subject to the same limitations, college facilities shall be made available for use by individuals or groups within the college community. Arrangements by both organizations and individuals must be made through the vice-president of administrative services. Allocation of space shall be made by such officer in accordance with these rules, board of trustees policy, college administration policy and procedure, and on the basis of time, space, priority of request, and the demonstrated needs of the applicant.

(4) In determining whether to accept a request for the use of college facilities the administration shall use the following priorities: First, activities of a nature that qualify for state FTE support; second, activities that are operated under a contract with the college; third, activities that are operated under the college's community service program; and fourth, activities that constitute rental of the facility that is related to training.

(5) The college may restrict an individual's or a group's use of college facilities if that person or group has, in the past, physically abused college facilities or is delinquent in payment of charges imposed for prior use of college facilities or equipment or supplies associated with such use. Charges may be imposed for damage or for any costs for the use of facilities or equipment or supplies associated with facility use. The individual, group, or organization requesting space will be required to state in writing in advance the general purpose of any meeting.

#### NEW SECTION

WAC 495D-140-030 STATEMENT OF INTENTIONS. The college neither intends nor desires to compete with any local agency or private enterprise in making its facilities available to the community. Privately operated facilities exist which are well qualified to best meet many community needs. The college encourages the community to patronize local businesses or agencies. With this approach, the college will work cooperatively with local private enterprise to the mutual benefit of all concerned.

#### NEW SECTION

WAC 495D-140-040 GENERAL POLICIES LIMITING USE. (1) College facilities may not be used for purposes of political campaigning by or for candidates who have filed for public office except for student-sponsored activities or forums.

(2) Religious groups or groups of persons meeting for religious purposes shall not, under any circumstances, use the college facilities as a permanent meeting place. Use may be intermittent only.

(3) The college reserves the right to prohibit the use of college facilities by groups which restrict membership or participation in a manner inconsistent with the college's commitment to nondiscrimination.

(4) No one may post promotional signs or posters on buildings, trees, walls, or bulletin boards, or distribute of samples outside the rooms or facilities to which access has been granted.

(5) These rules shall apply to recognized student groups using college facilities.

(6) Handbills, leaflets, and similar materials, except those which are commercial, obscene, or unlawful, may be distributed by nonstudents in designated areas on the campus where, and at times when, such distribution will not interfere with the orderly administration of the college affairs or the free flow of traffic. Any distribution of materials must be authorized in advance by the vice-president of administrative services and shall not be construed as support or approval of the content by the college community or the board of trustees.

(7) Use of audio amplifying equipment is permitted only in locations and at times which will not interfere with the normal conduct of college affairs as determined by the vice-president of administrative services.

(8) No person or group may use or enter onto college facilities having in their possession firearms or other dangerous weapons, even if licensed to do so, except commissioned police officers as prescribed by law.

(9) The right of peaceful dissent within the college community will be preserved. The college retains the right to take steps to insure the safety of individuals, the continuity of the educational process, and the protection of property. While peaceful dissent is acceptable, violence or disruptive behavior is not a legitimate means of dissent. Should any person, group, or organization attempt to resolve differences by means of violence, the college and its officials need not negotiate while such methods are employed.

(10) Orderly picketing and other forms of peaceful dissent are protected activities on and about the college premises. However, interference with free passage through areas where members of the college community have a right to be, interference with ingress and egress to college facilities, interruption of classes, injury to persons, or damage to property exceeds permissible limits.

(11) Where college space is used for an authorized function (such as a class or a public or private meeting under approved sponsorship, administrative functions, or service related activities), groups must obey or comply with directions of the designated administrative officer or individual in charge of the meeting.

(12) If a college facility abuts a public area or street, and if student activity, although on such public property, unreasonably interferes with ingress and egress to college buildings, the college may choose to impose its own sanctions although remedies might also be available through local law enforcement agencies.

#### NEW SECTION

WAC 495D-140-050 ADMINISTRATIVE CONTROL. The board hereby delegates to the president authority to set up administrative procedures for the use of college facilities; and to establish rental schedules, and fees for equipment and supplies associated with such rental, where appropriate.

#### NEW SECTION

WAC 495D-140-060 TRESPASS. (1) Individuals who are not students or members of the faculty or staff and who violate these rules will be advised of the specific nature of the violation, and if they persist in the violation, they will be requested by any appropriate administrator, to leave the college property. Such a request prohibits the entry of and withdraws the license or privilege to enter onto or remain upon any portion of the college facilities by the person or group of persons requested to leave. Such persons shall be subject to arrest under the provisions of chapter 9A.52 RCW.

(2) Members of the college community (students, faculty, and staff) who do not comply with these regulations will be reported to the appropriate college office or agency for action in accordance with these rules.

#### NEW SECTION

WAC 495D-140-070 PROHIBITED CONDUCT AT COLLEGE FACILITIES. (1) The use or possession of unlawful drugs or narcotics, not medically prescribed, or of intoxicants, except as specifically permitted by board of trustees policy as determined by the president or executive vice-president on college property or at college functions, is prohibited. Students under the influence of intoxicants, unlawful drugs, or narcotics while on college property are subject to disciplinary action.

(2) The use of tobacco, whether smoked, chewed, or otherwise used, is prohibited in accordance with state laws and health regulations. Smoking is permitted only where specifically designated by official signs posted on campus.

(3) Destruction of public property is also prohibited.

#### NEW SECTION

WAC 495D-140-080 CONTROL OF PETS IN COLLEGE FACILITIES. Pets are not permitted in campus buildings or on the grounds except guide or service dogs for the visually or hearing impaired. Exceptions to this rule may be granted by the director of campus services for good cause.

#### NEW SECTION

WAC 495D-140-090 BASIS OF FEE ASSESSMENT. (1) Use fees reflect the college's assessment of the present market, the cost of operations, and an evaluation of the intended purpose and its relationship to the purposes of this college. A current fee schedule is available to interested persons from the inservice coordinator.

(2) The college does not wish to compete with private enterprise. Therefore, the college reserves the right to deny applications for facility use when the administration feels a commercial facility should be patronized. Facility use will not be granted for a commercial activity at a rental rate, or upon terms, less than the full and fair rental value of premises used, except where such use is in support of the educational program of the college.

#### NEW SECTION

WAC 495D-140-100 APPLICATION PROCEDURES. (1) At least ten days prior to date of intended use of any college facility, or such lesser period as is approved by the vice-president of administrative services, an authorized representative of the requesting organization must submit proper and complete written application for use of college facilities which may be obtained through the college's inservice coordinator. A single application may be sufficient for a series of meetings by an organization unless those meetings vary significantly in some substantive way; if so, separate applications will be required.

(2) An authorized representative of the using organization shall sign the application, which upon approval by the vice-president of administrative services or designee shall serve as an agreement. By affixing a signature as representing the using organization, the signatory certifies that he or she has authority to enter into agreement on behalf of the organization and if the organization fails to pay the amount due, the signatory becomes responsible for all charges. These charges may include interest on overdue accounts, as specified on the facility use form but not less than one percent per month.

(3) For large events, events requiring expenditures on the part of the college, or events where significant areas are blocked out for the user, up to fifty percent advance deposit may be required at the time of application.

(4) The college reserves the right to make pricing changes without prior written notice, except that such price changes shall not apply to facility use agreements already approved by the administration.

(5) Use of a facility is limited to the facility specified on the agreement.



(6) The priorities for facility use place primary emphasis on regular college events and activities. The college reserves the right to cancel any agreement and refund any payments for use of college facilities and equipment when he or she deems such action advisable and in the college's best interests.

(7) In the event of a cancellation of a facility use permit by the applicant, that applicant and organization are liable for all college costs and expenses in preparing the facility for its use.

(8) Any admission charge is to be specified by the applicant and approved by the college in advance.

(9) Organizations using Lake Washington Technical College's facilities shall conduct all activities in accordance with applicable local, state, and federal laws including all policies adopted by the board of directors of college district 26.

#### NEW SECTION

**WAC 495D-140-110 SUPERVISION DURING ACTIVITY.** (1) Signatories to the facility use agreement as well as organization leaders are responsible for group conduct and are expected to remain with their group during activities. When the use of certain facilities makes it advisable, the college reserves the right to require that a staff member monitor the activity. Such service shall be paid at the current rate, by the organization requesting use of the facility, and does not relieve the organization from safeguarding the college's property.

(2) The security staff or some other authority of the college will open and lock all facilities used by signatories or organizations. Keys to buildings or facilities will not be issued or loaned to any using organization with the exception of keys to designated off-campus locations or by approval of the designated administrative officer.

#### Chapter 495D-168 WAC USE OF LIBRARY—FINES

#### NEW SECTION

**WAC 495D-168-010 TITLE.** WAC 495D-168-010 through 495D-168-040 will be known as the library-media center code of Lake Washington Technical College.

#### NEW SECTION

**WAC 495D-168-020 LOANS.** Materials from the college library media center are checked out only to the following groups:

- (1) All currently registered students of the college;
- (2) All current faculty and administrative staff members;
- (3) All persons currently employed in classified staff positions;
- (4) All holders of currently valid courtesy cards. This latter group includes members of the board of trustees, community educators whose work might necessitate usage of library-media materials, and other individuals who show a particular need for specialized items in the

library-media collections which are not available elsewhere;

(5) Students from other institutions with which the college library-media center has a reciprocal lending agreement through a "shared use plan." This group may use materials on a loan basis at the discretion of the circulation supervisor who will determine lending priorities based upon the current usage of individual items by Lake Washington Technical College students;

(6) Persons in charge of groups using college facilities under the terms of the facility use agreement; and

(7) Lake Washington School District No. 414 staff under terms of interlibrary loan agreements as may be approved by the college president or his or her designee.

#### NEW SECTION

**WAC 495D-168-030 FINES.** In cases where damage or loss of library material is evident, the offending patron will be assessed the replacement cost. In other instances where library-media materials are retained by the borrower beyond the designated due date, fines will be levied. When materials are not returned, or fines not paid, holds are placed on the transcript records of those involved in accordance with chapter 495D-122 WAC, or the matter may be referred for collection. In extreme cases, when expensive or valuable items are involved, the provisions of RCW 27.12.340 may be invoked.

#### NEW SECTION

**WAC 495D-168-040 STUDENT HANDBOOK.** Additional administrative policy and procedure governing the operation of the library-media center and the rules for loaning books, other print materials and non-print materials may be developed by the administration and published in the college policy and procedure manual and in the student handbook of Lake Washington Technical College.

#### NEW SECTION

**WAC 495D-168-050 INSPECTION.** The library shall have the right to inspect packages, brief cases, containers, articles, and materials leaving the library premises to prevent the unauthorized removal of library resources. The inspection may be done by persons or devices designed to detect unauthorized removals.

#### NEW SECTION

**WAC 495D-168-060 PROHIBITED ENTRY.** Food and beverages, animals, or other things detrimental to the library purpose are prohibited in the library, except as permitted by the librarian.

#### Chapter 495D-276 WAC ACCESS TO PUBLIC RECORDS

#### NEW SECTION

**WAC 495D-276-010 PURPOSE.** The purpose of this chapter is to ensure that College District 26 complies with the provisions of chapter 42.17 RCW and in

particular with those sections of that chapter dealing with public records.

#### NEW SECTION

WAC 495D-276-020 DEFINITIONS. (1) "Public record" includes any writing containing information relating to the conduct of government or the performance of any governmental or proprietary function prepared, owned, used or retained by any state or local agency regardless of physical form or characteristics.

(2) "Writing" means handwriting, typewriting, printing, photostating, photographing, and every other means of recording any form of communication or representation, including, but not limited to, letters, words, pictures, sounds or symbols, combination thereof and all papers, maps, magnetic or paper tapes, photographic films and prints, motion picture, film and video recordings, magnetic or punched cards, disks, drums, diskettes, sound recordings, and other documents including existing data compilations from which information may be obtained or translated.

(3) "College District 26" is an agency organized by statute pursuant to RCW 28B.50.040. College District 26 shall hereafter be referred to as the "district." Where appropriate, the term "district" also refers to the staff and employees of the district.

#### NEW SECTION

WAC 495D-276-030 DESCRIPTION OF CENTRAL AND FIELD ORGANIZATION OF COLLEGE DISTRICT 26. (1) College District 26 is a state agency established and organized under the authority of chapter 28B.50 RCW for the purpose of implementing the educational goals established by the legislature in RCW 28B.50.020. The administrative office of the district is located on the Lake Washington Technical College campus within the city of Kirkland, Washington. The Lake Washington Technical College campus likewise comprises the central headquarters for all operations of the district.

(2) The district is operated under the supervision and control of a board of trustees. The board of trustees consists of five members appointed by the governor. The board of trustees normally meets at least once each month, as provided in WAC 495D-104-010. The board of trustees employs a president, an administrative staff, members of the faculty, and other employees. The board of trustees takes such actions and promulgates such rules and policies in harmony with the rules established by the state board for community and technical colleges, as are necessary to the administration and operation of the district.

(3) The president of the district is responsible to the board of trustees for the operation and administration of the district. A detailed description of the administrative organization of the district is contained within the policies and procedures manual for Lake Washington Technical College, a current copy of which is available for inspection at the administrative office of the district.

#### NEW SECTION

WAC 495D-276-040 OPERATIONS AND PROCEDURES. (1) Formal decision-making procedures are established by the board of trustees through rules promulgated in accordance with the requirements of chapter 34.05 RCW, the Administrative Procedure Act.

(2) Informal decision-making procedures at the college, as established by the board of trustees, are set forth in the policies and procedures manual of Lake Washington Technical College, a current copy of which is available for inspection at the administrative office of the district.

#### NEW SECTION

WAC 495D-276-050 PUBLIC RECORDS AVAILABLE. All public records of the district, as defined in this chapter, are deemed to be available for public inspection and copying pursuant to these rules, except as otherwise provided by RCW 42.17.310 or other statutes.

#### NEW SECTION

WAC 495D-276-060 PUBLIC RECORDS OFFICER. The district's public records shall be in the charge of the public records officer designated by the president. The person so designated shall be located in the district administrative office. The public records officer shall be responsible for the following: Implementation of the district's rules regarding release of public records, coordinating district employees in this regard, and generally ensuring compliance by district employees with the public records disclosure requirements in chapter 42.17 RCW.

#### NEW SECTION

WAC 495D-276-070 OFFICE HOURS. Public records shall be available for inspection and copying during the customary office hours of the district. For purposes of this chapter, the customary office hours shall be from 7:30 a.m. to 4:30 p.m., Monday through Friday, excluding legal holidays and holidays established by the college calendar.

#### NEW SECTION

WAC 495D-276-080 REQUESTS FOR PUBLIC RECORDS. In accordance with the requirements of RCW 42.17.290 that agencies prevent unreasonable invasions of privacy, protect public records from damage or disorganization, and prevent excessive interference with essential functions of the agency, public records are only obtainable by members of the public when those members of the public comply with the following procedures:

(1) A request shall be made in writing. A form prescribed by the district shall be available at the district administrative office. The completed form shall be presented to the public records officer or, if the public records officer is not available, to any member of the district's staff at the district administrative office during

customary office hours. The request shall include the following information:

- (a) The name of the person requesting the record;
- (b) The time of day and calendar date on which the request was made;
- (c) The nature of the request;
- (d) If the matter requested is referenced within the current index maintained by the public records officer, a reference to the requested record as it is described in such current index;
- (e) If the requested matter is not identifiable by reference to the current index, an appropriate description of the record requested.

(2) In all cases in which a member of the public is making a request, it shall be the obligation of the public records officer, or person to whom the request is made, to assist the member of the public in identifying the public record requested.

#### NEW SECTION

WAC 495D-276-090 **COPYING**. No fee shall be charged for the inspection of public records. The district may impose a reasonable charge for providing copies of public records and for the use by any person of agency equipment to copy public records but such charges shall not exceed the amount necessary to reimburse the district for its actual costs incident to such copying. No person shall be released a record so copied until and unless the person requesting the copied public record has tendered payment for such copying to the appropriate district employee. All charges must be paid by money order, cashier's check, or cash in advance.

#### NEW SECTION

WAC 495D-276-100 **DETERMINATION REGARDING EXEMPT RECORDS**. (1) The district reserves the right to determine that a public record requested in accordance with the procedures outlined in WAC 495D-276-080 is exempt pursuant to RCW 42.17.310 or other statute. Such determination may be made in consultation with an assistant attorney general assigned to the district.

(2) Pursuant to RCW 42.17.260, the district reserves the right to delete identifying details when it makes available or publishes any public record when there is reason to believe that disclosure of such details would be an unreasonable invasion of personal privacy or impair a vital governmental interest: **PROVIDED, HOWEVER**, In each case, the justification for the deletion shall be explained fully in writing.

(3) Responses to requests for public records must be made promptly. For the purposes of this section, a prompt response occurs if the person requesting the public record is notified within five business days as to whether his request for a public record will be honored.

(4) Every denial of a request for public records must be accompanied by a written statement, signed by the public records officer or his/her designee, specifying the reason for the denial, a statement of the specific exemption authorizing the withholding of the record, and a

brief explanation of how the exemption applies to the public record withheld.

#### NEW SECTION

WAC 495D-276-110 **REVIEW OF DENIALS OF PUBLIC RECORDS REQUESTS**. (1) Any person who objects to the denial of a request for a public record may petition for prompt review of such decision by tendering a written request for a brief adjudicative proceeding. The written request shall specifically refer to the written statement which constituted or accompanied the denial.

(2) The written request by a person demanding prompt review of a decision denying a public record shall be submitted to the vice-president of administrative services, or his or her designee.

(3) Within two business days after receiving the written request by a person petitioning for a prompt review of a decision denying a public record, the vice-president, or his or her designee, shall complete such review.

(4) During the course of the review the vice-president or his or her designee shall consider the obligations of the district to comply with the intent of chapter 42.17 RCW insofar as it requires providing full public access to official records, but shall also consider the exemptions provided in RCW 42.17.310 or other pertinent statutes, and the provisions of the statute which require the district to protect public records from damage or disorganization, prevent excessive interference with essential functions of the agency, and prevent any unreasonable invasion of personal privacy by deleting identifying details.

(5) The vice-president or designee's decision shall be final unless the requisition files a written appeal with the president under RCW 34.05.491.

#### NEW SECTION

WAC 495D-276-120 **PROTECTION OF PUBLIC RECORDS**. Public records and a facility for their inspection will be provided by the public records officer. Such records shall not be removed from the place designated. Copies of such records may be arranged according to the provisions of WAC 495D-276-090.

#### NEW SECTION

WAC 495D-276-130 **RECORDS INDEX**. (1) The district has available for the use of all persons a current index which provides identifying information as to the following records issued, adopted, or promulgated by the district after September 1, 1991:

(a) Final opinions, including concurring and dissenting opinions, as well as orders, made in the adjudication of cases;

(b) Those statements of policy and interpretations of policy, statute, and the constitution which have been adopted by the agency;

(c) Administrative staff manuals and instructions to staff that affect a member of the public;

(d) Planning policies and goals, and interim and final planning decisions;

(e) Factual staff reports and studies, factual consultant's reports and studies, scientific reports and studies,

and any other factual information derived from tests, studies, reports, or surveys, whether conducted by public employees or others; and

(f) Correspondence, and materials referred to therein, by and with the agency relating to any regulatory, supervisory, or enforcement responsibilities of the agency, whereby the agency determines, or opines upon, or is asked to determine or opine upon, the rights of the state, the public, a subdivision of state government, or any private party.

(2) The current index maintained by the district shall be available to all persons under the same rules and on the same conditions as are applied to public records available for inspection.

#### NEW SECTION

WAC 495D-276-140 ADOPTION OF FORM. The district shall adopt an appropriate form for use by all persons requesting inspection and/or copying or copies of its records.

#### Chapter 495D-280 WAC FAMILY EDUCATIONAL RIGHTS AND PRIVACY ACT

#### NEW SECTION

WAC 495D-280-010 GENERAL POLICY. Lake Washington Technical College implements the policy contained in this chapter in compliance with the Family Educational Rights and Privacy Act (20 U.S.C. § 1232g) and its implementing regulation (34 C.F.R. § 99). Briefly, Lake Washington Technical College is required to provide students with access to their own education records, to permit students to challenge their records on the grounds that they are inaccurate, misleading, or otherwise in violation of the student's privacy or other right, to obtain written consent before releasing certain information and to notify students of these rights.

#### NEW SECTION

WAC 495D-280-015 DEFINITIONS. For the purposes of this policy, the following definitions of terms apply:

(1) "Student" means any individual who is or has been in attendance at Lake Washington Technical College and for whom the college maintains education records.

(2) "Education records" are defined as those records, files, and documents (in handwriting, print, tapes, film, microfiche, or other medium) maintained by Lake Washington Technical College which contain information directly related to the individual student. Education records include only the following:

(a) Records pertaining to admission, advisement, registration, grading, and progress toward a certificate or degree that are maintained by the registrar.

(b) Testing information used for advisement purposes by the counseling center.

(c) Information concerning payment of fees as maintained by the registrar.

(d) Financial aid information as collected by the financial aid office.

(e) Information regarding students' participating in student government that is maintained by the student government office.

(3) "Directory Information" means the student's name, address, telephone number, date and place of birth, major field of study, eligibility for and participation in officially recognized activities and organizations, dates of attendance, degrees, certificates, and awards received, and the most recent previous educational agency or institution attended by the student. Directory information may be disclosed at the discretion of the college and without the consent of the student unless he or she elects to prevent disclosure as provided for in WAC 495D-280-070.

(4) "Written consent" means a written authorization for disclosure of student education records which is:

(a) Signed;

(b) Dated;

(c) Which specifies the records to be disclosed; and

(d) Which specifies to whom disclosure is authorized.

(5) "Personally identifiable" means data or information which includes: The name of the student, the student's parent(s), or other family members; a personal identifier such as the student's Social Security number or student number; or a list of personal characteristics which would make the student's identity easily traceable.

#### NEW SECTION

WAC 495D-280-020 ANNUAL NOTIFICATION OF RIGHTS. Lake Washington Technical College will notify students of their rights under the Family Educational Rights and Privacy Act of 1974 by publication in the college catalog and quarterly schedule of courses. The college shall make available upon request a copy of the policy governing release of student records. In addition, the college shall post at conspicuous places on the campus information regarding the existence of this policy and of the availability of copies.

#### NEW SECTION

WAC 495D-280-030 PROCEDURE TO INSPECT EDUCATION RECORDS. (1) Students may inspect and review their education records upon request to the appropriate college official as designated in WAC 495D-280-110.

(2) Students must submit to the appropriate college official a written request which identifies as precisely as possible the record or records he or she wishes to inspect.

(3) The appropriate college official will make the needed arrangements for access as promptly as possible and notify the student of the time and place where the records may be inspected. Access must be given in forty-five days or less from the receipt of the request.

#### NEW SECTION

WAC 495D-280-040 DISCLOSURE OF EDUCATION RECORDS. (1) Disclosure of education records. In addition to "directory information" the college

may, at its discretion, make disclosures from education records of students to the following listed parties:

(a) College officials including college administrative and clerical staff, faculty, and students officially elected or appointed to the associated students of Lake Washington Technical College or employed by the college. Access or release of records to the above is permissible only when the information is required for advisement, counseling, recordkeeping, reporting, or other legitimate educational interest consistent with their specific duties and responsibilities;

(b) To officials of another school in which the student seeks or intends to enroll;

(c) To authorized federal, state, or local officials as required by law;

(d) In connection with financial aid for which the student has applied or received;

(e) To appropriate parties in a health or safety emergency;

(f) To accrediting organizations to carry out their functions;

(g) To parents of an eligible student who claim the student as a dependent for income tax purposes; and

(h) To comply with a judicial order or a lawfully issued subpoena.

(2) The college shall not permit access to or the release of education records or personally-identifiable information contained therein, other than "directory information," without the written consent of the student, to any party other than the above.

(3) Education records released to third parties shall be accompanied by a statement indicating that the information cannot be subsequently released in a personally identifiable form to other parties without obtaining the consent of the student. The college is not precluded from permitting third party disclosure to other parties listed in (a) through (h) of this subsection.

#### NEW SECTION

WAC 495D-280-050 LIMITS ON RIGHTS TO REVIEW AND INSPECT AND OBTAIN COPIES OF EDUCATION RECORDS. (1) When a record contains information about more than one student, the student may inspect and review only the records which relate to him or her.

(2) Lake Washington Technical College reserves the right to refuse to permit a student to inspect the following records:

(a) The financial statement of the student's parents;

(b) Letters and statements of recommendation for which the student has waived his or her right of access, or which were placed in file before January 1, 1975;

(c) Records connected with an application to attend Lake Washington Technical College if that application was denied; and

(d) Those records which are excluded from the Federal Rights and Privacy Act definition of education records.

(3) Lake Washington Technical College reserves the right to deny transcripts or copies of records not required to be made available by the Federal Educational

Rights and Privacy Act in any of the following situations:

(a) The student has an unpaid financial obligation to the college;

(b) There is an unresolved disciplinary action against the student.

#### NEW SECTION

WAC 495D-280-060 RECORD OF REQUEST AND DISCLOSURES. (1) The college shall maintain a record of requests for and disclosures of personally-identifiable information in the education records of each student. The record maintained under this section shall be available for inspection and review as provided in WAC 495D-280-050.

(2) The college shall maintain the record with the education records of the student as long as the records are maintained.

(3) The record must include:

(a) The names of parties who have received personally-identifiable information;

(b) The interest the parties had in requesting or obtaining the information; and

(c) The names and interests of additional parties to which the reviewing educational agency or institution may disclose or redisclose the information.

(4) The following parties may inspect the record of requests and disclosures relating to a student:

(a) The student;

(b) The college officials who are responsible for the custody of the records; and

(c) Persons authorized to audit the record keeping procedures of the college.

(5) The college is not required to maintain a record if the request was from, or the disclosure was to:

(a) The student;

(b) A school official;

(c) A party with written consent from the student; or

(d) A party seeking directory information.

#### NEW SECTION

WAC 495D-280-070 DISCLOSURE OF DIRECTORY INFORMATION. Directory information may be disclosed at the discretion of the college and without the consent of the student unless the student elects to prevent disclosure by filing a written request with the registrar to prevent disclosure. The request continues in effect according to its terms unless revoked in writing by the student.

#### NEW SECTION

WAC 495D-280-080 REQUESTS FOR CORRECTIONS, HEARINGS, ADDING STATEMENTS TO EDUCATION RECORDS. Students have the right to request to have records corrected that they believe are inaccurate, misleading, or in violation of their privacy rights. Following are the procedures for the correction of records:

(1) A student must submit a written request to amend his or her education record to the appropriate college

official responsible for the custody of the record as designated in WAC 495D-280-110. The request must identify the part of the record he/she wants changed and specify why the record is believed to be inaccurate, misleading or in violation of his or her privacy or other rights.

(2) A student whose request for amendment of his or her education record has been denied may request a hearing by submitting a written request to the administrator of student services within ten days following the denial. The written request must be signed by the student and shall indicate the reasons why the records should be amended. The administrator of student services shall notify the student of the hearing within thirty days after receipt of a properly filed request. In no case will the notification be less than ten days in advance of the date, time, and place of the hearing.

(3) The hearing shall be a brief adjudicative proceeding as provided in RCW 34.05.482 and 34.05.485 through 34.05.494 and shall be conducted by the administrator of student services or other appropriate administrator. At the hearing, the student shall be afforded a full and fair opportunity to present evidence relevant to the issues raised in the original request to amend the student's education records. The student may be assisted by one or more individuals, including an attorney.

(4) The administrator of student services or other appropriate administrator will prepare a written decision, within thirty days after the conclusion of the hearing, based solely on the evidence presented at the hearing. The decision will include a summary of the evidence presented and the reasons for the decision. A copy of the decision shall be made available to the student.

(5) If the administrator of student services or other appropriate administrator decides the information is inaccurate, misleading, or in violation of the student's right of privacy, the custodian of the record will amend the record and notify the student, in writing, that the record has been amended.

(6) If the administrator of student services or other appropriate administrator decides that the challenged information is not inaccurate, misleading, or in violation of the student's right of privacy, the committee will notify the student in writing that the student has a right to place in the record a rebuttal statement commenting on the challenged information and/or a statement setting forth reasons for disagreeing with the decision.

(7) The student's rebuttal statement will be maintained as part of the student's education records as long as the contested portion is maintained. If the contested portion of the education record is disclosed, the statement will also be disclosed.

#### NEW SECTION

WAC 495D-280-090 FEES FOR COPIES. Copies of student records shall be made at the expense of the requesting party at actual cost for copying as posted at the registration office.

#### NEW SECTION

WAC 495D-280-100 WAIVER. A student may waive any of his or her rights under this chapter by submitting a written, signed, and dated waiver to the office of the registrar. Such a waiver shall be specific as to the records and persons or institutions covered. A waiver continues in effect according to its terms unless revoked in writing which is signed and dated.

#### NEW SECTION

#### WAC 495D-280-110 TYPE AND LOCATION OF EDUCATION RECORDS.

Types	Location	Custodian
Admission, Testing Records	Admissions Office	Administrator of Student Services
Cumulative Academic, Registration Records	Registration Office	Assistant Registrar
Payment of Tuition Records	Accounting Office	Director of Accounting Services
Student Government Participation Records	SAC Office	Secretary
Financial Aid, Student Employment Records	Financial Aid Office	Supervisor

#### NEW SECTION

WAC 495D-280-120 REMEDY FOR STUDENTS PROTECTED BY THIS ACT. A student may file a written complaint with the United States Department of Education regarding an alleged violation of the Federal Education Rights and Privacy Act. The address is:

Family Policy and Regulations Office  
U.S. Department of Education  
Washington, D.C. 20202

#### Chapter 495D-300 WAC GRIEVANCE POLICIES AND PROCEDURES— DISCRIMINATION

#### NEW SECTION

WAC 495D-300-010 PREAMBLE. Lake Washington Technical College is covered by the Age Discrimination in Employment Act, Titles VII and IX of the Civil Rights Act of 1964, by section 504 of the Rehabilitation Act of 1974, Chapter 49.60 RCW, and the Americans With Disabilities Act. The college prohibits discrimination on the basis of race, color, religion, marital status, age, handicap/disability, national origin, sex, sexual orientation, sexual harassment, or any other unlawful basis. Any applicant for admission, enrolled student, applicant for employment, or employee of Lake Washington Technical College who believes she/he has been discriminated against may lodge an institutional grievance by following the procedures below.

#### NEW SECTION

WAC 495D-300-015 POLICY STATEMENT ON DISABILITIES. Students with documented disabilities as defined in PL 101-336 who meet admission qualifications will be provided reasonable accommodation. Accommodations may be made in the style of instructional delivery, method of evaluation, or curricular aides. The

college will not lower the standard measurement of competency for the certificate of merit or the standards for a degree.

Specific support services and auxiliary aids will be determined prior to registration. State vocational rehabilitation agencies or common school districts charged with providing support to handicapped students will retain primacy of responsibility for necessary auxiliary aids.

Lake Washington Technical College encourages all students to achieve the highest level of skill development possible, as well as to achieve the ability to function independently in the workplace. Therefore, accommodations will be provided on a decreasing basis to the extent that the student's reasonable requirements diminish as the student becomes increasingly successful in training and nears job placement.

#### NEW SECTION

**WAC 495D-300-020 INFORMAL PROCEDURE.** All employees and students should feel free to discuss perceived discrimination with the individual immediately in charge, such as the first-line supervisor or instructor, to see if the situation can be resolved informally. Employees and students may also consult directly with the college affirmative action officer, or coordinator for disabled student services for grievances related to handicap/disability, without making a formal written complaint, and this consultation will be considered confidential. Employees and students are not required to use the informal process and may go directly to the formal procedure.

Any college official receiving a discrimination complaint shall contact the affirmative action officer or designee as soon as reasonably convenient. The college official shall arrange for the complainant to receive a copy of the grievance procedure.

#### NEW SECTION

**WAC 495D-300-030 FORMAL PROCEDURE.** Employees and students must make a written complaint concerning discriminatory behavior to the affirmative action officer or designee.

(1) Complaints will be held in confidence. No action against the person accused will ordinarily be taken on behalf of the complainant unless the complainant consents to be identified to the one accused in connection with the investigation, although the college reserves all rights to take appropriate corrective measures regardless of actions of the complainant.

(2) The complainant may bring a person of his or her choice to the initial or subsequent complaint meetings.

(3) The affirmative action officer or designee shall give a copy of these regulations and any applicable board policy to the person making the formal complaint and to the accused.

(4) The result of that consultation and any investigation made will be communicated to the complainant before any further action is taken. The affirmative action officer or designee will be responsible for investigating

the complaint and discussing the complaint with the complainant and the accused.

(5) The affirmative action officer will make a written report and/or recommendation to the appointing authority or appropriate disciplinary authority within a reasonable time following the close of the investigation or meeting. An informal meeting may be substituted for investigation if the complainant and the accused agree.

(6) Appropriate corrective measures, if any, will be decided by the appointing disciplinary authority upon consultation with the affirmative action officer and the appropriate administrators and consistent with applicable bargained agreement provisions and state statutes. If an accused employee or student disagrees with the determination or appropriateness of the corrective measures, that individual may contest those measures through any available faculty or classified grievance procedures, if they are covered by a bargained agreement, or the student disciplinary code.

(7) In the absence of an applicable grievance procedure under a collective bargaining agreement, the accused employee or student may, within thirty days of the corrective measure(s), file with the executive vice-president for instruction or vice-president for administrative services a written request for adjudication. That vice-president shall meet with the employee or student to determine whether the matter should be heard as a regular or brief adjudicative proceeding. That vice-president shall be the presiding officer for the proceeding.

(8) The presiding officer may affirm, modify, or reverse the corrective measure(s).

(9) The decision of the presiding officer shall be final unless, within twenty-one days after it is served, a party files with the president a written request for administrative review or the president or designee decides to conduct such review.

(10) Information will be entered in the personnel or student file only to the extent that a formal reprimand or other disciplinary action has been taken. If no disciplinary action is taken, the affirmative action officer will keep a record of the investigation accessible to the president, the complainant and the accused for a period of three years and then that record will be destroyed. If a formal complaint is filed with an outside state or federal agency, files will be maintained until the complaint is resolved. When such files are used, written notice will be placed in the file indicating the person using the file and the date used.

#### NEW SECTION

**WAC 495D-300-040 OTHER REMEDIES.** These procedures outlined in WAC 495D-300-010 through 495D-300-030, are internal college procedures and, as such, serve to resolve complaints within the college's administrative framework. These procedures do not replace an individual's timely complaint with an external agency such as the Office of Civil Rights, Equal Employment Opportunity Commission, or the Washington state human rights commission.

Chapter 495D-325 WAC  
STATE ENVIRONMENTAL POLICY ACT RULES

NEW SECTION

WAC 495D-325-010 IMPLEMENTATION OF STATE ENVIRONMENTAL POLICY ACT. (1) It shall be the policy of Lake Washington Technical College District 26 that all actions taken by the district shall comply with the provisions of chapter 43.21C RCW (the State Environmental Policy Act), chapters 197-11 and 132-24 WAC.

(2) The president of the district or his or her designee shall be responsible for administering and implementing this policy.

**WSR 92-15-082**  
**PERMANENT RULES**  
**LOTTERY COMMISSION**  
[Filed July 16, 1992, 1:25 p.m.]

Date of Adoption: July 10, 1992.

Purpose: To establish the game play rules and criteria for determining winners of Instant Game Nos. 81 ("Joker Poker"), 82 ("10th Anniversary Game"), 83 ("Surprise Package"), 84 ("Fat Cat"), and 85 ("7-11-21").

Statutory Authority for Adoption: RCW 67.70.040.

Pursuant to notice filed as WSR 92-12-091 on June 3, 1992.

Effective Date of Rule: Thirty-one days after filing.

July 15, 1992  
Evelyn P. Yenson  
Director

NEW SECTION

WAC 315-11-810 DEFINITIONS FOR INSTANT GAME NUMBER 81 ("JOKER POKER").

(1) Play symbols: The following are the "play symbols": "A"; "K"; "Q"; "J"; "10"; "9"; "8"; "7"; "6"; "5"; "4"; and "🀄." One of these play symbols appears in each of the ten play spots under the latex covering on the front of the ticket. The ten play spots are divided into two horizontal rows ("hands") of five adjoining spots. Each horizontal set of five adjoining play spots shall constitute one game and shall be known as a playfield. Each ticket shall have two playfields.

(2) Captions: The small printed characters appearing below each play symbol which verify and correspond with that play symbol. The caption is a spelling out, in full or abbreviated form of the play symbol. One and only one of these captions appears under each play symbol. For Instant Game Number 81, the captions which correspond with and verify the play symbols are:

<u>PLAY SYMBOL</u>	<u>CAPTION</u>
🀄	JKR
A	ACE
K	KNG
Q	QUE
J	JAC
10	TEN
9	NIN
8	EGT
7	SVN
6	SIX
5	FIV
4	FOR

(3) Validation number: The unique nine-digit number on the front of the ticket. The number is covered by latex covering.

(4) Pack-ticket number: The eleven-digit number of the form 08100001-000 printed on the front of the ticket. The first eight digits of the pack-ticket number for Instant Game Number 81 constitute the "pack number" which starts at 08100001; the last three digits constitute the "ticket number" which starts at 000 and continues through 399 within each pack of tickets.

(5) Retailer verification codes: Codes consisting of small letters found under the removable latex covering on the front of the ticket which the lottery retailer uses to verify instant winners of \$25.00 and less. For Instant Game Number 81, the retailer verification codes are three-letter codes, with each letter appearing in a varying three of eight locations among the play symbols on the front of the ticket. The retailer verification codes are:

<u>VERIFICATION CODE</u>	<u>PRIZE</u>
ONE	\$1.00
TWO	\$2.00 (\$2; \$1 and \$1)
FOR	\$4.00 (\$4; \$2 and \$2)
SVN	\$7.00
SVT	\$17.00

(6) Pack: A set of four hundred fanfolded instant game tickets separated by perforations and packaged in plastic shrinkwrapping.

NEW SECTION

WAC 315-11-811 CRITERIA FOR INSTANT GAME NUMBER 81. (1) The price of each instant game ticket shall be \$1.00.

(2) Determination of prize winning tickets: An instant prize winner is determined in the following manner:

(a) The bearer of a ticket having the following play symbols in any of the five spots in any order within a playfield beneath the removable covering on the front of the ticket shall win the following prize:

Two 9's - win	\$1.00
Two 10's - win	\$2.00
Two J's - win	\$4.00
Two Q's - win	\$7.00
Two K's - win	\$17.00
Two A's - win	\$50.00
Two 's - win	\$21,000



(b) Play symbols from one playfield may not be mixed, combined, or intermingled with play symbols from the other playfield.

(c) The ticket shall bear a legend which lists the winning play symbols and their corresponding prizes.

(d) The bearer of a ticket having winning play symbols in both games shall win the total amount of the prizes won in each game.

(3) No portion of the display printing nor any extraneous matter whatever shall be usable or playable as a part of the instant game.

(4) The determination of prize winners shall be subject to the general ticket validation requirements of the lottery as set forth in WAC 315-10-070, to the particular ticket validation requirements for Instant Game Number 81 set forth in WAC 315-11-812, to the confidential validation requirements established by the director, and to the requirements stated on the back of each ticket.

(5) Notwithstanding any other provisions of these rules, the director may:

(a) Vary the length of Instant Game Number 81; and/or

(b) Vary the number of tickets sold in Instant Game Number 81 in a manner that will maintain the estimated average odds of purchasing a winning ticket.

**NEW SECTION**

WAC 315-11-812 TICKET VALIDATION REQUIREMENTS FOR INSTANT GAME NUMBER 81. (1) In addition to meeting all other requirements in these rules and regulations, to be a valid instant game ticket for Instant Game Number 81 all of the following validation requirements apply.

(a) Exactly one play symbol must appear in each of the ten play spots under the latex covering on the front of the ticket.

(b) Each of the ten play symbols must have a caption below the play symbol, and each must agree with its caption.

(c) The display printing and the printed numbers, letters, and symbols on the ticket must be regular in every respect and correspond precisely with the artwork on file with the director. The numbers, letters, and symbols shall be printed as follows:

Play Symbols	Play Symbol Font
Captions	Caption Font
Pack-Ticket Number	Validation Font
Validation Number	Validation Font
Retail Verification Code	Validation Font

(d) Each of the play symbols and its caption, the validation number, pack-ticket number, and retailer verification code must be printed in black ink.

(e) Each of the play symbols must be exactly one of those described in WAC 315-11-810(1) and each of the captions must be exactly one of those described in WAC 315-11-810(2).

(2) Any ticket not passing all the validation requirements in WAC 315-10-070 and subsection (1) of this section is invalid and ineligible for any prize.

**NEW SECTION**

WAC 315-11-820 DEFINITIONS FOR INSTANT GAME NUMBER 82 ("10TH ANNIVERSARY GAME"). (1) Play symbols: The following are the "play symbols": "\$1.00"; "\$2.00"; "\$4.00"; "\$10.00"; "\$20.00"; "\$100.00"; and "\$10,000." One of these play symbols appears in each of the nine play spots under the latex covering on the front of the ticket.

(2) Play symbol captions: The small printed characters appearing below each play symbol which verify and correspond with that play symbol. The caption is a spelling out, in full or abbreviated form of the play symbol. One and only one of these captions appears under each play symbol. For Instant Game Number 82, the captions which correspond with and verify the play symbols are:

<u>PLAY SYMBOL</u>	<u>CAPTION</u>
\$1.00	ONE DOL
\$2.00	TWO DOL
\$4.00	FOR DOL
\$10.00	TEN DOL
\$20.00	TWY DOL
\$100.00	ONEHUND
\$10,000	TENTHOU

(3) Validation number: The unique nine-digit number on the front of the ticket. The number is covered by latex covering.

(4) Pack-ticket number: The eleven-digit number of the form 08200001-000 printed on the front of the ticket. The first three digits are the game identifier. The first eight digits of the pack-ticket number for Instant Game Number 82 constitute the "pack number" which starts at 08200001; the last three digits constitute the "ticket number" which starts at 000 and continues through 399 within each pack of tickets.

(5) Retailer verification codes: Codes consisting of small letters found under the removable latex covering on the front of the ticket which the lottery retailer uses to verify instant winners of \$25.00 or less. For Instant Game Number 82, the retailer verification codes are three-letter codes, with each letter appearing in a varying three of six locations among the play symbols on the front of the ticket. The retailer verification codes are:

<u>VERIFICATION CODE</u>	<u>PRIZE</u>
ONE	\$ 1.00
TWO	\$ 2.00
FOR	\$ 4.00
TEN	\$ 10.00
TWY	\$ 20.00

(6) Pack: A set of four hundred fanfolded instant game tickets separated by perforations and packaged in plastic shrinkwrapping.

**NEW SECTION**

WAC 315-11-821 CRITERIA FOR INSTANT GAME NUMBER 82. (1) The price of each instant game ticket shall be \$1.00.

(2) Determination of prize winning tickets: An instant winner is determined in the following manner:

The bearer of a ticket having the following play symbols in any three of the nine spots beneath the removable covering on the front of the ticket shall win the following prize:

Three \$ 1.00 play symbols	-	Win \$ 1.00
Three \$ 2.00 play symbols	-	Win \$ 2.00
Three \$ 4.00 play symbols	-	Win \$ 4.00
Three \$ 10.00 play symbols	-	Win \$ 10.00
Three \$ 20.00 play symbols	-	Win \$ 20.00
Three \$ 100.00 play symbols	-	Win \$ 100.00
Three \$ 10,000 play symbols	-	Win \$ 10,000

(3) No portion of the display printing nor any extraneous matter whatever shall be usable or playable as a part of the instant game.

(4) The determination of prize winners shall be subject to the general ticket validation requirements of the lottery as set forth in WAC 315-10-070, to the particular ticket validation requirements for Instant Game Number 82 set forth in WAC 315-11-822, to the confidential validation requirements established by the director, and to the requirements stated on the back of each ticket.

(5) Notwithstanding any other provisions of these rules, the director may:

(a) Vary the length of Instant Game Number 82; and/or

(b) Vary the number of tickets sold in Instant Game Number 82 in a manner that will maintain the estimated average odds of purchasing a winning ticket.

**NEW SECTION**

WAC 315-11-822 TICKET VALIDATION REQUIREMENTS FOR INSTANT GAME NUMBER 82. (1) A valid instant game ticket for Instant Game Number 82 shall meet all of the following validation requirements as well as all other requirements in these rules and regulations.

(a) Exactly one play symbol must appear in each of the nine play spots under the removable latex covering on the front of the ticket.

(b) Each of the nine play symbols must have a caption below it, and each must agree with its caption.

(c) The display printing and the printed numbers, letters, and symbols on the ticket must be regular in every respect and correspond precisely with the artwork on file with the director. The numbers, letters, and symbols shall be printed as follows:

Play Symbols	Play Symbol Font
Captions	Caption Font
Pack-Ticket Number	Validation Font
Validation Number	Validation Font
Retail Verification Code	Validation Font

(d) Each of the play symbols and its caption, the validation number, pack-ticket number, and retailer verification code must be printed in black ink.

(e) Each of the play symbols must be exactly one of those described in WAC 315-11-820(1) and each of the captions must be exactly one of those described in WAC 315-11-820(2).

(2) Any ticket not passing all the validation requirements in WAC 315-10-070 and subsection (1) of this section is invalid and ineligible for any prize.

**NEW SECTION**

WAC 315-11-830 DEFINITIONS FOR INSTANT GAME NUMBER 83 ("SURPRISE PACKAGE"). (1) Play symbols: The following are the "play symbols": "\$1.00"; "\$2.00"; "\$4.00"; "\$8.00"; "\$14.00"; "\$24.00"; "\$40.00"; "\$80.00"; and "\$5,000." One of these play symbols appears in each of the nine play spots under the latex covering on the front of the ticket.

(2) Play symbol captions: The small printed characters appearing below each play symbol which verify and correspond with that play symbol. The caption is a spelling out, in full or abbreviated form of the play symbol. One and only one of these captions appears under each play symbol. For Instant Game Number 83, the captions which correspond with and verify the play symbols are:

<u>PLAY SYMBOL</u>	<u>CAPTION</u>
\$1.00	ONE DOL
\$2.00	TWO DOL
\$4.00	FOR DOL
\$8.00	EGT DOL
\$14.00	FORTEEN
\$24.00	TWYFOR\$
\$40.00	\$FORTY\$
\$80.00	\$EIGHTY
\$5,000	FIVTHOU

(3) Validation number: The unique nine-digit number on the front of the ticket. The number is covered by latex covering.

(4) Pack-ticket number: The eleven-digit number of the form 08300001-000 printed on the front of the ticket. The first three digits are the game identifier. The first eight digits of the pack-ticket number for Instant Game Number 83 constitute the "pack number" which starts at 08300001; the last three digits constitute the "ticket number" which starts at 000 and continues through 399 within each pack of tickets.

(5) Retailer verification codes: Codes consisting of small letters found under the removable latex covering on the front of the ticket which the lottery retailer uses to verify instant winners of \$25.00 or less. For Instant Game Number 83, the retailer verification codes are three-letter codes, with each letter appearing in a varying three of six locations among the play symbols on the front of the ticket. The retailer verification codes are:

<u>VERIFICATION CODE</u>	<u>PRIZE</u>
ONE	\$ 1.00
TWO	\$ 2.00
FOR	\$ 4.00
EGT	\$ 8.00
FRN	\$ 14.00
TTF	\$ 24.00

(6) Pack: A set of four hundred fanfolded instant game tickets separated by perforations and packaged in plastic shrinkwrapping.

**NEW SECTION**

WAC 315-11-831 CRITERIA FOR INSTANT GAME NUMBER 83. (1) The price of each instant game ticket shall be \$1.00.

(2) Determination of prize winning tickets: An instant prize winner is determined in the following manner:

The bearer of a ticket having the following play symbols in any three of the nine spots beneath the removable covering on the front of the ticket shall win the following prize:

Three	\$1.00	play symbols	– Win	\$1.00
Three	\$2.00	play symbols	– Win	\$2.00
Three	\$4.00	play symbols	– Win	\$4.00
Three	\$8.00	play symbols	– Win	\$8.00
Three	\$14.00	play symbols	– Win	\$14.00
Three	\$24.00	play symbols	– Win	\$24.00
Three	\$40.00	play symbols	– Win	\$40.00
Three	\$80.00	play symbols	– Win	\$80.00
Three	\$5,000	play symbols	– Win	\$5,000

(3) No portion of the display printing nor any extraneous matter whatever shall be usable or playable as a part of the instant game.

(4) The determination of prize winners shall be subject to the general ticket validation requirements of the lottery as set forth in WAC 315-10-070, to the particular ticket validation requirements for Instant Game Number 83 set forth in WAC 315-11-832, to the confidential validation requirements established by the director, and to the requirements stated on the back of each ticket.

(5) Notwithstanding any other provisions of these rules, the director may:

(a) Vary the length of Instant Game Number 83; and/or

(b) Vary the number of tickets sold in Instant Game Number 83 in a manner that will maintain the estimated average odds of purchasing a winning ticket.

**NEW SECTION**

WAC 315-11-832 TICKET VALIDATION REQUIREMENTS FOR INSTANT GAME NUMBER 83. (1) A valid instant game ticket for Instant Game Number 83 shall meet all of the following validation requirements as well as all other requirements in these rules and regulations.

(a) Exactly one play symbol must appear in each of the nine play spots under the removable latex covering on the front of the ticket.

(b) Each of the nine play symbols must have a caption below it, and each must agree with its caption.

(c) The display printing and the printed numbers, letters, and symbols on the ticket must be regular in every respect and correspond precisely with the artwork on file with the director. The numbers, letters, and symbols shall be printed as follows:

Play Symbols	Play Symbol Font
Captions	Caption Font
Pack-Ticket Number	Validation Font
Validation Number	Validation Font
Retail Verification Code	Validation Font

(d) Each of the play symbols and its caption, the validation number, pack-ticket number and retailer verification code must be printed in black ink.

(e) Each of the play symbols must be exactly one of those described in WAC 315-11-830(1) and each of the captions must be exactly one of those described in WAC 315-11-830(2).

(2) Any ticket not passing all the validation requirements in WAC 315-10-070 and subsection (1) of this section is invalid and ineligible for any prize.

**NEW SECTION**

WAC 315-11-840 DEFINITIONS FOR INSTANT GAME NUMBER 84 ("FAT CAT"). (1) Play symbols: The following are the "play symbols": " "; "\$1.00"; "\$2.00"; "\$4.00"; "\$9.00"; "\$19.00"; "\$50.00"; "\$100.00"; "\$10,000." One of these symbols appears in each of the six blocks under the scratch-off material covering the game play data.

(2) Play symbol captions: The small printed characters appearing below each play symbol which verify and correspond with that play symbol. The caption is a spelling out, in full or abbreviated form of the play symbol. One and only one of these captions appears under each play symbol. For Instant Game Number 84, the captions which correspond with and verify the play symbols are:

<u>PLAY SYMBOL</u>	<u>CAPTION</u>
♣	FAT CAT
\$ 1.00	ONE DOL
\$ 2.00	TWO DOL
\$ 4.00	FOR DOL
\$ 9.00	NIN DOL
\$ 19.00	NINTEEN
\$ 50.00	\$FIFTY\$
\$ 100.00	ONEHUND
\$ 10,000	TENTHOU

(3) Validation number: The unique nine-digit number on the front of the ticket. The number is covered by latex covering.

(4) Pack-ticket number: The eleven-digit number of the form 08400001-000 printed on the front of the ticket. The first eight digits of the pack-ticket number for Instant Game Number 84 constitute the "pack number" which starts at 08400001; the last three digits constitute the "ticket number" which starts at 000 and continues through 399 within each pack of tickets.

(5) Retailer verification codes: Codes consisting of small letters found under the removable covering on the front of the ticket which the lottery retailer uses to verify instant winners of \$25.00 or less. For Instant Game Number 84, the retailer verification code is a three-letter code, with each letter appearing in a varying three of six locations beneath the removable covering and among the play symbols on the front of the ticket. The retailer verification codes are:

<u>VERIFICATION CODE</u>	<u>PRIZE</u>
ONE	\$ 1.00
TWO	\$ 2.00
FOR	\$ 4.00
NIN	\$ 9.00
NIT	\$19.00

(6) Pack: A set of four hundred fanfolded instant game tickets separated by perforations and packaged in plastic shrinkwrapping.

**NEW SECTION**

WAC 315-11-841 CRITERIA FOR INSTANT GAME NUMBER 84. (1) The price of each instant game ticket shall be \$1.00.

(2) Determination of prize winning tickets: An instant prize winner is determined in the following manner:

The bearer of a ticket having the following play symbol in any three of the six spots beneath the removable covering on the front of the ticket shall win the following prize:

Three \$ 1.00 play symbols	-	Win \$ 1.00
Three \$ 2.00 play symbols	-	Win \$ 2.00
Three \$ 4.00 play symbols	-	Win \$ 4.00
Three \$ 9.00 play symbols	-	Win \$ 9.00
Three \$ 19.00 play symbols	-	Win \$ 19.00
Three \$ 50.00 play symbols	-	Win \$ 50.00
Three \$ 100.00 play symbols	-	Win \$ 100.00
Three \$ 10,000 play symbols	-	Win \$ 10,000

(3) No portion of the display printing nor any extraneous matter whatever shall be usable or playable as a part of the instant game.

(4) The determination of prize winners shall be subject to the general ticket validation requirements of the lottery as set forth in WAC 315-10-070, to the particular ticket validation requirements for Instant Game Number 84 set forth in WAC 315-11-842, to the confidential validation requirements established by the director, and to the requirements stated on the back of each ticket.

(5) There will be a grand prize drawing held in conjunction with Instant Game Number 84. It will be conducted at a time and place and pursuant to procedures to be established and announced by the director. Qualifying entries from Instant Game Number 84 will be entered into the grand prize drawing.

(a) To be eligible for entry into the drawings held pursuant to this section, an entrant must:

(i) Be eligible to win a prize pursuant to chapter 67.70 RCW and Title 315 WAC.

(ii) Collect three tickets each of which have one play symbol.

(iii) Write or print legibly the entrant's name and address on each and every ticket. An entry containing more than one name shall be disqualified.

(iv) Place the tickets in an envelope. An envelope which contains extraneous material or which has had the exterior altered for the apparent sole purpose of making the envelope more prominent shall be disqualified.

(v) Mail the envelope with proper postage and a legible return address of the entrant to the address specified in the player's brochure, or deliver it in person during

normal business hours to lottery headquarters or any of the regional offices at the address listed in the player's brochure.

(b) There is no limit to the number of entries a person may submit, but each entry must be submitted in a separate envelope and both the entry and the entrant of each must meet the qualifications set forth above.

(c) An entry which contains one or more stolen tickets may be disqualified by the director.

(d) A nonconforming entry, at the sole discretion of the director, may be disqualified.

(e) The lottery shall not be responsible for any other material, including winning tickets, mailed or delivered to the "GRAND PRIZE DRAWING." All mail not drawn will be shredded unopened.

(f) The lottery shall not be responsible for any entries mailed or delivered to the wrong address.

(6) Selection of the winning grand prize drawing entrants shall be made in the following manner:

(a) Weekly drawings will be held to select a total of fifty winners who will each be awarded a \$1,000 prize. Entries addressed to Grand Prize Drawing and received by the lottery at its grand prize drawing P.O. Box, or at lottery headquarters or at one of the regional offices by 5:00 p.m. local time two business days prior to each weekly drawing shall be entitled to participation in that week's drawing. The weekly drawings will be conducted at times and places and pursuant to procedures established and announced by the director.

(b) A drawing will be held to select ten grand prize drawing finalists from the fifty \$1,000 winners.

(c) The ten finalists selected for participation in the grand prize drawing will each win a prize ranging in amount from \$10,000 to \$100,000. In the event that the aggregate prize amount won by the ten finalist at the grand prize drawing is less than \$550,000, each finalist shall also receive one-tenth of the difference between \$550,000 and the aggregate amount won.

(d) An entrant must be eligible for entry into the drawings held pursuant to these rules to participate in the grand prize drawing or to receive any prize money.

(7) Notwithstanding any other provisions of these rules, the director may:

(a) Vary the length of Instant Game Number 84; and/or

(b) Vary the number of tickets sold in Instant Game Number 84 in a manner that will maintain the estimated average odds of purchasing a winning ticket.

**NEW SECTION**

WAC 315-11-842 TICKET VALIDATION REQUIREMENTS FOR INSTANT GAME NUMBER 84. (1) A valid instant game ticket for Instant Game Number 84 shall meet all of the following validation requirements as well as all other requirements in these rules and regulations:

(a) Exactly one play symbol must appear under each of the six rub-off spots on the front of the ticket.

(b) Each of the six play symbols must have a caption below it and each must agree with its caption.

(c) The display printing and the printed numbers, letters, and symbols on the ticket must be regular in every

respect and correspond precisely with the artwork on file with the director. The numbers, letters, and symbols shall be printed as follows:

Play Symbols	Play Symbol Font
Captions	Caption Font
Pack-Ticket Number	Validation Font
Validation Number	Validation Font
Retail Verification Code	Validation Font

(d) Each of the play symbols and its caption, the validation number, pack-ticket number, and retailer verification code must be printed in black ink.

(e) Each of the play symbols must be exactly one of those described in WAC 315-11-840(1) and each of the captions must be exactly one of those described in WAC 315-11-840(2).

(2) Any ticket not passing all the validation requirements in WAC 315-10-070 and subsection (1) of this section is invalid and ineligible for any prize.

**NEW SECTION**

WAC 315-11-850 DEFINITIONS FOR INSTANT GAME NUMBER 85 ("7-11-21"). (1) Play symbols: The following are the "play symbols": "0"; "1"; "2"; "3"; "4"; "5"; "6"; and "9." One of these play symbols appears in each of the six play spots under the latex covering on the front of the ticket. The six play spots are divided into two horizontal rows of three adjoining spots. Each horizontal set of three adjoining play spots shall constitute one game and shall be known as a playfield. Each ticket shall have two playfields.

(2) Play symbol captions: The small printed characters appearing below each play symbol which verify and correspond with that play symbol. The caption is a spelling out, in full or abbreviated form of the play symbol. One and only one of these captions appears under each play symbol. For Instant Game Number 85, the captions which correspond with and verify the play symbols are:

<u>PLAY SYMBOL</u>	<u>CAPTION</u>
0	ZRO
1	ONE
2	TWO
3	THR
4	FOR
5	FIV
6	SIX
9	NIN

(3) Prize symbols: The following are the "prize symbols": "\$1.00"; "\$2.00"; "\$4.00"; "\$7.00"; "\$11.00"; "\$21.00"; "\$70.00"; "\$1,100"; and "\$21,000." One of these prize symbols appears under the box on front of the ticket which has "PRIZE" printed on the latex covering. The prize box shall be contiguous to the playfield.

(4) Prize symbol captions: The small printed characters appearing below the prize symbol which verify and correspond with the prize symbol. The caption is a spelling out, in full or abbreviated form, of the prize symbol. Only one caption appears under the prize symbol. For Instant Game Number 85, the captions which correspond with and verify the prize symbols are:

<u>PRIZE SYMBOL</u>	<u>CAPTION</u>
\$1.00	ONE DOL
\$2.00	TWO DOL
\$4.00	FOR DOL
\$7.00	SEV DOL
\$11.00	ELV DOL
\$21.00	TTN DOL
\$70.00	\$SVNTY\$
\$1,100	ELVHDRD
\$21,000	TTNTHOU

(5) Validation number: The unique nine-digit number on the front of the ticket. The number is covered by latex covering.

(6) Pack-ticket number: The eleven-digit number of the form 08500001-000 printed on the front of the ticket. The first three digits are the game identifier. The first eight digits of the pack-ticket number for Instant Game Number 85 constitute the "pack number" which starts at 08500001; the last three digits constitute the "ticket number" which starts at 000 and continues through 399 within each pack of tickets.

(7) Retailer verification codes: Codes consisting of small letters found under the removable latex covering on the front of the ticket which the lottery retailer uses to verify instant winners of \$25.00 or less. For Instant Game Number 85, the retailer verification codes are three-letter codes, with each letter appearing in a varying three of six locations among the play symbols on the front of the ticket. The retailer verification codes are:

<u>VERIFICATION CODE</u>	<u>PRIZE</u>
ONE	\$1.00
TWO	\$2.00
FOR	\$4.00
SVN	\$7.00
ELV	\$11.00
TTN	\$21.00

(8) Pack: A set of four hundred fanfolded instant game tickets separated by perforations and packaged in plastic shrinkwrapping.

**NEW SECTION**

WAC 315-11-851 CRITERIA FOR INSTANT GAME NUMBER 85. (1) The price of each instant game ticket shall be \$1.00.

(2) Determination of prize winning tickets: An instant prize winner is determined in the following manner:

(a) The bearer of a ticket in which the sum of the three play symbols in one game is 7, 11, or 21 shall win the prize specified in the prize box.

(b) Play symbols from one playfield may not be mixed, combined, or intermingled with play symbols from the other playfield.

(3) No portion of the display printing nor any extraneous matter whatever shall be usable or playable as a part of the instant game.

(4) The determination of prize winners shall be subject to the general ticket validation requirements of the lottery as set forth in WAC 315-10-070, to the particular ticket validation requirements for Instant Game

Number 85 set forth in WAC 315-11-852, to the confidential validation requirements established by the director, and to the requirements stated on the back of each ticket.

(5) Notwithstanding any other provisions of these rules, the director may:

(a) Vary the length of Instant Game Number 85; and/or

(b) Vary the number of tickets sold in Instant Game Number 85 in a manner that will maintain the estimated average odds of purchasing a winning ticket.

**NEW SECTION**

**WAC 315-11-852 TICKET VALIDATION REQUIREMENTS FOR INSTANT GAME NUMBER 85.** (1) A valid instant game ticket for Instant Game Number 85 shall meet all of the following validation requirements as well as all other requirements in these rules and regulations.

(a) Exactly one play symbol must appear in each of the six play spots under the removable latex covering on the front of the ticket.

(b) Each of the six play symbols must have a caption below it, and each must agree with its caption.

(c) The display printing and the printed numbers, letters, and symbols on the ticket must be regular in every respect and correspond precisely with the artwork on file with the director. The numbers, letters, and symbols shall be printed as follows:

Play Symbols	Play Symbol Font
Captions	Caption Font
Pack-Ticket Number	Validation Font
Validation Number	Validation Font
Retail Verification Code	Validation Font

(d) Each of the play symbols and its caption, the validation number, pack-ticket number, and retailer verification code must be printed in black ink.

(e) Each of the play symbols must be exactly one of those described in WAC 315-11-850(1) and each of the play symbol captions must be exactly one of those described in WAC 315-11-850(2). The prize symbol must be exactly one of those described in WAC 315-11-850(3) and the prize symbol caption must be exactly one of those described in WAC 315-11-850(4).

(2) Any ticket not passing all the validation requirements in WAC 315-10-070 and subsection (1) of this section is invalid and ineligible for any prize.

**WSR 92-15-083  
WITHDRAWAL OF PROPOSED RULES  
LOTTERY COMMISSION**  
[Filed July 16, 1992, 1:26 p.m.]

Pursuant to WAC 1-21-060, notice is hereby provided that proposed amendments to WAC 315-33A-060 and 315-33B-060 filed in WSR 92-12-091 of the Washington Administrative Code are hereby withdrawn.

Evelyn P. Yenson  
Director

**WSR 92-15-084  
PERMANENT RULES  
DEPARTMENT OF HEALTH**  
[Order 288—Filed July 16, 1992, 2:42 p.m.]

Date of Adoption: July 15, 1992.

Purpose: To adjust the fee schedule for home health, hospice, and home care agencies to cover the operating costs of the programs.

Citation of Existing Rules Affected by this Order: Amending WAC 246-327-990, 246-331-990, and 246-336-990.

Statutory Authority for Adoption: RCW 43.70.250.

Pursuant to notice filed as WSR 92-10-013 on April 24, 1992.

Changes Other than Editing from Proposed to Adopted Version: A special fee category was created for agencies with 15 or less employees, thereby reducing their fees. A larger discount was given to agencies with multiple licenses.

Effective Date of Rule: Thirty-one days after filing.

July 15, 1992

Kristine M. Gebbie  
Secretary

**AMENDATORY SECTION** (Amending Order 122, filed 12/27/90, effective 1/31/91)

**WAC 246-327-990 FEES.** (1) ~~((Agencies licensed only as))~~ Home health agencies licensed under chapter ~~((71.127))~~ 70.127 RCW shall submit an annual license fee ~~((of six hundred dollars to the department.~~

(2) ~~The department shall assess annual fees for agencies with combinations of licenses under RCW 70.127-110, the following fee schedule applies:~~

Categories of Agencies	Fee When All	Fee When Agencies
	Agencies at One Address	At Separate Addresses Within One County
Home Health and Hospice	\$ 800	\$ 900
Home Health and Home Care	1,000	1,100
Hospice and Home Care	700	800
Home Health and Home Health	1,000	1,100
Hospice and Hospice	800	900
Home Care and Home Care	1,000	1,100
Any combination of three of the same or different categories	1,200	1,300
Any combination of four of the same or different categories	1,600	1,700
Any combination of five of the same or different categories	2,000	2,100))

as follows:

(a) Agencies with fifty or more employees, one thousand three hundred dollars;

(b) Agencies with less than fifty but more than fifteen employees, one thousand one hundred dollars; and

(c) Agencies with fifteen or less employees, eight hundred eighty dollars.

(2) An agency applying for additional home health, hospice, or home care licenses shall receive a fee reduction of two hundred fifty dollars for each additional license in accordance with the provisions of RCW 70.127.110.

**AMENDATORY SECTION** (Amending Order 122, filed 12/27/90, effective 1/31/91)

WAC 246-331-990 FEES. (1) Hospice agencies licensed under chapter 70.127 RCW shall submit an annual license fee ~~((of five hundred dollars to the department.~~

(2) ~~The department shall assess annual fees for combinations of initial licenses or renewal of combination of licenses under RCW 70.127.110 as follows:~~

Categories of Agencies	Fee When All Agencies at One Address	Fee When Agencies At Separate Addresses Within One County
Home Health and Hospice	\$ 800	\$ 900
Home Health and Home Care	1,000	1,100
Hospice and Home Care	700	800
Home Health and Home Health	1,000	1,100
Hospice and Hospice	800	900
Home Care and Home Care	1,000	1,100
Any combination of three of the same or different categories	1,200	1,300
Any combination of four of the same or different categories	1,600	1,700
Any combination of five of the same or different categories	2,000	2,100))

as follows:

(a) Agencies with fifty or more employees, one thousand two hundred dollars;

(b) Agencies with less than fifty but more than fifteen employees, one thousand dollars; and

(c) Agencies with fifteen or less employees, eight hundred dollars.

(2) An agency applying for additional home health, hospice, or home care licenses shall receive a fee reduction of two hundred fifty dollars for each additional license in accordance with the provisions of RCW 70.127.110.

**AMENDATORY SECTION** (Amending Order 122, filed 12/27/90, effective 1/31/91)

WAC 246-336-990 FEES. (1) Home care agencies licensed under chapter 70.127 RCW shall submit an annual license fee ~~((of six hundred twenty-five dollars to the department.~~

~~(2) The department shall assess annual fees for combinations of initial licenses or renewal of combination of licenses under RCW 70.127.110 as follows:~~

Categories of Agencies	Fee When All Agencies at One Address	Fee When Agencies At Separate Addresses Within One County
Home Health and Hospice	\$ 800	\$ 900
Home Health and Home Care	1,000	1,100
Hospice and Home Care	700	800
Home Health and Home Health	1,000	1,100
Hospice and Hospice	800	900
Home Care and Home Care	1,000	1,100
Any combination of three of the same or different categories	1,200	1,300
Any combination of four of the same or different categories	1,600	1,700
Any combination of five of the same or different categories	2,000	2,100))

as follows:

(a) Agencies with fifty or more employees, one thousand twenty-five dollars;

(b) Agencies with less than fifty but more than fifteen employees, eight hundred twenty-five dollars; and

(c) Agencies with fifteen or less employees, six hundred sixty dollars.

(2) An agency applying for additional home health, hospice, or home care licenses shall receive a fee reduction of two hundred fifty dollars for each additional license in accordance with the provisions of RCW 70.127.110.

**WSR 92-15-085  
PROPOSED RULES  
DEPARTMENT OF HEALTH**  
[Filed July 16, 1992, 2:47 p.m.]

Original Notice.

Title of Rule: These rules require background inquiries for persons that have direct contact with patients and/or residents of boarding homes, hospitals, hospice care centers, residential treatment facilities for psychiatrically impaired children and youth, adult residential rehabilitation centers and private adult treatment homes, home health agencies, childbirth centers, hospice agencies, home care agencies, second trimester abortion facilities, and rural health care facilities. WAC 246-316-020 Boarding home license application—Department denial, suspension, revocation of license, 246-316-040 Requirement for and qualifications of boarding home administrator, 246-316-045 Criminal history, disclosure, and background inquiries, 246-316-050 Staff and employees—Other persons living in boarding home, 246-318-040 Personnel, 246-318-042 Criminal history, disclosure, and background inquiries, 246-321-018 Criminal history, disclosure, and background inquiries, 246-323-022 Criminal history, disclosure, and background inquiries, 246-325-022 Criminal history, disclosure, and background inquiries, 246-327-090 Criminal history, disclosure, and background inquiries, 246-329-035 Criminal history, disclosure, and background inquiries, 246-331-100 Criminal history, disclosure, and background inquiries, 246-336-100 Criminal history, disclosure, and background inquiries, 246-340-085 Criminal history, disclosure, and background inquiries, 246-388-070 Personnel, and 246-388-072 Criminal history, disclosure, and background inquiries.

Statutory Authority for Adoption: RCW 43.43.830.

Statute Being Implemented: RCW 43.43.830.

Summary: Requires background checks for individuals working with vulnerable children and adults.

Name of Agency Personnel Responsible for Drafting, Implementation and Enforcement: Kathy Stout, 1112 S.E. Quince Street, Olympia, (206) 753-5916.

Name of Proponent: Department of Health, governmental.

Rule is not necessitated by federal law, federal or state court decision.

Explanation of Rule, its Purpose, and Anticipated Effects: Requires criminal history background checks of individuals working with vulnerable children and adults. These rules are intended to reduce the incidence of mistreatment, abuse and exploitation of vulnerable citizens of Washington state.

Proposal Changes the Following Existing Rules: Changes several existing rules to coincide with the new requirement.

**Small Business Economic Impact Statement**

**Chapter 246-316 WAC, Boarding homes**

This rule implements RCW 43.43.830 through 43.43.842, which require background checks of individuals who may have direct unsupervised contact with: Children under sixteen years of age; vulnerable adults as defined under RCW 43.43.830; and developmentally disabled individuals.

The department has determined that employees, volunteers, contractors and students that have direct contact with residents of boarding home agencies meet this criteria.

The initial cost to boarding home agencies is proportional to the size of the business (number of employees, etc.). Recurring costs will be determined by the rate of staff turn-over, which, in most cases, will correspond to the size of the business.

The Washington State Patrol will provide these background checks for \$10.00 each.

An example of the cost of compliance for a small versus a big business follows:

	SMALL BUSINESS (6 employees + 4 volunteers)	LARGE BUSINESS (60 employees + 40 volunteers)
INITIAL COST	\$ 100	\$ 1000
ANNUAL COST (Using a 10% annual staffing turn-over rate)	\$ 10	\$ 100

Additional administrative costs that are required to comply with this rule are negligible.

**Chapter 246-318 WAC, Hospitals**

This rule implements RCW 43.43.830 through 43.43.842, which require background checks of individuals who may have direct unsupervised contact with: Children under sixteen years of age; vulnerable adults as defined under RCW 43.43.830; and developmentally disabled individuals.

The department has determined that employees, volunteers, contractors and students that have direct contact with patients of hospitals meet this criteria.

The initial cost to hospitals is proportional to the size of the business (number of employees, etc.). Recurring costs will be determined by the rate of staff turn-over, which, in most cases, will correspond to the size of the business.

The Washington State Patrol will provide these background checks for \$10.00 each.

An example of the cost of compliance for a small versus a big business follows:

	SMALL BUSINESS (6 employees + 4 volunteers)	LARGE BUSINESS (60 employees + 40 volunteers)
INITIAL COST	\$ 100	\$ 1000
ANNUAL COST (Using a 10% annual staffing turn-over rate)	\$ 10	\$ 100

Additional administrative costs that are required to comply with this rule are negligible.

**Chapter 246-327 WAC, Home health agency; chapter 246-331 WAC, Hospice agency; and chapter 246-336 WAC, Home care agencies**

This rule implements RCW 43.43.830 through 43.43.842, which require background checks of individuals who may have direct unsupervised contact with: Children under sixteen years of age; vulnerable adults as defined under RCW 43.43.830; and developmentally disabled individuals.

The department has determined that employees, volunteers, contractors and students that have direct contact with patients of home health, hospice and home care agencies meet this criteria.

The initial cost to these agencies is proportional to the size of the business (number of employees, etc.). Recurring costs will be determined by the rate of staff turn-over, which, in most cases, will correspond to the size of the business.

The Washington State Patrol will provide these background checks for \$10.00 each.

An example of the cost of compliance for a small versus a big business follows:

	SMALL BUSINESS (6 employees + 4 volunteers)	LARGE BUSINESS (60 employees + 40 volunteers)
INITIAL COST	\$ 100	\$ 1000
ANNUAL COST (Using a 10% annual staffing turn-over rate)	\$ 10	\$ 100

Additional administrative costs that are required to comply with this rule are negligible.

**Chapter 246-323 WAC, Residential treatment facilities for psychiatrically impaired children and youth; and chapter 246-325 WAC, Adult residential rehabilitation centers**

This rule implements RCW 43.43.830 through 43.43.842, which require background checks of individuals who may have direct unsupervised contact with: Children under sixteen years of age; vulnerable adults as defined under RCW 43.43.830; and developmentally disabled individuals.

The department has determined that employees, volunteers, contractors and students that have direct contact with residents of residential treatment facilities for psychiatrically impaired children and youth and adult residential rehabilitation agencies meet this criteria.



The initial cost to these agencies is proportional to the size of the business (number of employees, etc.). Recurring costs will be determined by the rate of staff turn-over, which, in most cases, will correspond to the size of the business.

The Washington State Patrol will provide these background checks for \$10.00 each.

An example of the cost of compliance for a small versus a big business follows:

	SMALL BUSINESS (6 employees + 4 volunteers)	LARGE BUSINESS (60 employees + 40 volunteers)
INITIAL COST	\$ 100	\$ 1000
ANNUAL COST (Using a 10% annual staffing turn-over rate)	\$ 10	\$ 100

Additional administrative costs that are required to comply with this rule are negligible.

Chapter 246-321 WAC, Hospice care center; chapter 246-329 WAC, Childbirth centers; chapter 246-340 WAC, Abortion facilities; and chapter 246-388 WAC, Rural health care facilities

This rule implements RCW 43.43.830 through 43.43.842, which require background checks of individuals who may have direct unsupervised contact with: Children under sixteen years of age; vulnerable adults as defined under RCW 43.43.830; and developmentally disabled individuals.

The department has determined that employees, volunteers, contractors and students that have direct contact with patients of hospice, childbirth, abortion, and rural health care agencies meet this criteria.

The initial cost to these agencies is proportional to the size of the business (number of employees, etc.). Recurring costs will be determined by the rate of staff turn-over, which, in most cases, will correspond to the size of the business.

The Washington State Patrol will provide these background checks for \$10.00 each.

An example of the cost of compliance for a small versus a big business follows:

	SMALL BUSINESS (6 employees + 4 volunteers)	LARGE BUSINESS (60 employees + 40 volunteers)
INITIAL COST	\$ 100	\$ 1000
ANNUAL COST (Using a 10% annual staffing turn-over rate)	\$ 10	\$ 100

Additional administrative costs that are required to comply with this rule are negligible.

Hearing Location: General Administration (GA) Auditorium, 11th and Columbia, Olympia, Washington 98504, on August 26, 1992, at 1:00 p.m.

Submit Written Comments to: Ann Foster, Rules Coordinator, P.O. Box 47902, Olympia, WA 98504, by August 24, 1992.

Date of Intended Adoption: September 2, 1992.

July 15, 1992  
Kristine Gebbie  
Secretary

AMENDATORY SECTION (Amending Order 224, filed 12/23/91, effective 1/23/92)

WAC 246-316-020 BOARDING HOME LICENSE APPLICATION—DEPARTMENT DENIAL, SUSPENSION, REVOCATION OF LICENSE. (1) Boarding home license applicants shall:

(a) Submit appropriate, signed, completed department application forms to the department;

(b) Apply at least thirty days prior to expiration of license for renewal;

(c) Promptly report changes in information related to the application including identity of:

(i) Officers and directors if operated by a legally incorporated entity; and

(ii) Partners if a legal partnership.

(2) The department shall:

(a) Evaluate qualifications of persons named in boarding home license application prior to granting initial and subsequent licenses;

(b) Deny, suspend, or revoke a boarding home license if the department finds persons named unqualified or unable to operate or direct operation of the facility as described in chapter 18.20 RCW and this chapter;

(c) Determine if reasonable relationship exists between any previous conviction of the applicant and ability to competently, safely oversee, or operate a boarding home;

(d) Deny, suspend, or revoke a boarding home license if any person named:

(i) Was previously denied a license to operate an agency for care of children, aged, ill, or infirm in Washington or elsewhere;

(ii) Had a license to operate an agency for treatment or care of people revoked or suspended;

(iii) Has a record of a criminal or civil conviction (~~(for: (A) Operating an agency for care of aged, children, ill, or infirm without an appropriate, applicable license; or~~

~~(B) Any crime involving physical harm to another person.~~

~~(iv) Is identified on department abuse registry as perpetrator of substantiated abuse described in chapter 26.44 RCW;~~

~~(v)) as specified in WAC 246-316-045 (2)(b);~~

~~(iv) Committed, permitted, aided, or abetted an illegal act on boarding home premises;~~

~~((v)) (v) Demonstrated cruelty, abuse, negligence, assault, or indifference to welfare and well-being of a resident;~~

~~((vii)) (vi) Failed to exercise fiscal accountability and responsibility involving:~~

(A) A resident;

(B) The department;

(C) Public agencies; or

(D) The business community.

(3) The department may grant a license to operate a boarding home to previously disqualified licensees as specified in subsection (2) of this section if such person provides evidence including demonstrated ability to operate a boarding home according to applicable laws and rules.

(4)(a) The department's notice of a denial, suspension, modification, or revocation of a license shall be consistent with RCW 43.70.115. An applicant or license holder has the right to an adjudicative proceeding to contest a license decision.

(b) A license applicant or holder contesting a department decision shall within twenty-eight days of receipt of the decision:

(i) File a written application for an adjudicative proceeding by a method showing proof of receipt with the Administrative Hearings Unit, Department of Health, 1300 Quince Street S.E., P.O. Box 47851, Olympia, WA 98504-7851; and

(ii) Include in or with the application:

(A) A specific statement of the issue or issues and law involved;

(B) The grounds for contesting the department decision; and

(C) A copy of the contested department decision.

(c) The proceeding is governed by the Administrative Procedure Act (chapter 34.05 RCW), this chapter, and chapter 246-08 WAC. If a provision in this chapter conflicts with chapter 246-08 WAC, the provision in this chapter governs.

**AMENDATORY SECTION** (Amending Order 224, filed 12/23/91, effective 1/23/92)

WAC 246-316-040 REQUIREMENT FOR AND QUALIFICATIONS OF BOARDING HOME ADMINISTRATOR. (1) Boarding homes shall have continuous availability of an administrator or designated alternate who:

- (a) Is available in person or by phone or page at all times;
- (b) Is at least twenty-one years of age;
- (c) Is not a resident as defined in WAC 246-316-010(30);
- (d) Possesses a high school diploma or equivalent unless administering a boarding home in Washington state prior to January 1, 1958;
- (e) Has demonstrated competence and experience in management of a boarding home or completed high school or post-high school courses including:

- (i) Basic accounting, except when a designated alternate administrator is in charge for two weeks or less;
- (ii) Management including personnel management; and
- (iii) Care of persons characteristic of those admitted or accepted as residents in a specific boarding home, such as frail elderly, developmentally disabled, or mentally ill persons.

(f) Meets requirements as specified in WAC ((246-316-050 (2)(b))) 246-316-045.

(2) Boarding homes shall notify the department when changes in the administrator occur including:

- (a) Provide written notice to the department of new administrator's name upon appointment; and
- (b) Provide a statement of administrator's compliance with this section and WAC 246-316-050.

**NEW SECTION**

WAC 246-316-045 CRIMINAL HISTORY, DISCLOSURE, AND BACKGROUND INQUIRIES. (1) Licensees or license applicants shall require disclosure statements as specified under RCW 43.43.830 through 43.43.842 for all prospective employees, volunteers, contractors, and students who may have unsupervised direct contact with:

- (a) Children under sixteen years of age;
  - (b) Vulnerable adults as defined under RCW 43.43.830;
  - (c) Developmentally disabled individuals.
- (2) Except as provided in RCW 43.43.842 and in subsection (3) of this section, licensees shall:
- (a) Ensure background inquiries are completed on all prospective employees and volunteers having direct contact with vulnerable adults;
  - (b) Not hire or retain, directly or by contract, any employee, volunteer, or student, having direct contact with vulnerable adults, who was:
    - (i) Convicted of a crime against persons as defined in RCW 43.43.830;
    - (ii) Convicted of crimes relating to financial exploitation of a vulnerable adult as defined in RCW 43.43.830;
    - (iii) Found in any disciplinary board final decision to have abused a vulnerable adult under RCW 43.43.830; or
    - (iv) The subject in a protective proceeding under chapter 74.34 RCW.

(3) A licensee may conditionally employ, contract with or accept as a volunteer, an individual pending a background inquiry, provided, the licensee requests the inquiry within three business days of the conditional acceptance of the individual.

(4) Licensees shall, before employing directly or by contract, or accepting any person as a volunteer or student having direct contact with a vulnerable adult:

- (a) Inform the prospective employee, contractor, volunteer, or student of the requirement for a background inquiry under RCW 43.43.830 through 43.43.842;
- (b) Require a person to sign an acknowledgement statement that a background inquiry will be made;
- (c) Verbally inform the person of the background inquiry results within seventy-two hours of receipt; and
- (d) Offer to provide a copy of the background inquiry results to the prospective employee, contractor, volunteer, or student (within ten days of receipt).

(5) Licensees shall:

- (a) Require all current employees, contractors, volunteers, and students engaged on or after July 22, 1989, to sign disclosure statements; and

(b) Ensure background inquiries are conducted on all individuals identified in (a) of this subsection having direct contact with vulnerable adults.

- (6) The licensee shall establish and implement procedures ensuring:
  - (a) All disclosure statements and background inquiry responses are maintained in a confidential and secure manner;
  - (b) Disclosure statements and background inquiry responses are used for employment purposes only;
  - (c) Disclosure statements and background inquiry responses are not disclosed to any person except:
    - (i) The person about whom the licensee made the disclosure or background inquiry;
    - (ii) Authorized state and federal employees; and
    - (iii) The Washington state patrol auditor; and
  - (d) A record of findings are retained during and at least two years following termination of employment.

(7) The department shall:

- (a) Conduct background inquiries specified under RCW 43.43.830 on all licensees or license applicants who can financially exploit or have direct contact with vulnerable adults;
- (b) Notify the licensee or license applicant of the results of the background inquiry;
- (c) Review records required under this section;
- (d) Investigate allegations of noncompliance with RCW 43.43.830 through 43.43.842, when necessary, in consultation with law enforcement personnel; and
- (e) Use information collected under this section solely for the purpose of determining eligibility for licensure or relicensure as required under RCW 43.43.842.

(8) The department may require that licensees complete additional disclosure statements or background inquiries for employees, contractors, volunteers, or students, if the department has reason to believe that offenses specified under RCW 43.43.830 have occurred since completion of the original disclosure statement or background inquiry.

**AMENDATORY SECTION** (Amending Order 121, filed 12/27/90, effective 1/31/91)

WAC 246-316-050 STAFF AND EMPLOYEES—OTHER PERSONS LIVING IN BOARDING HOME. (1) Boarding homes shall provide:

- (a) Sufficient, trained staff in each boarding home to provide:
  - (i) Services and care needed by residents;
  - (ii) Maintenance of the facility for resident health and safety;
  - (iii) Implementation of fire and disaster plans.
- (b) One or more staff aged eighteen years of age or older:
  - (i) On boarding home premises at all times when residents are present;
    - (ii) Capable of assisting all residents present in boarding home; and
    - (c) Staff present and responsible for "on-premises" supervision when any resident is working as staff or employed by the boarding home unless approved in advance by the department;
  - (d) Orientation and appropriate training of employees and staff pertinent to expected duties including:
    - (i) Organization of boarding home;
    - (ii) Physical facility layout;
    - (iii) Specific duties and responsibilities;
    - (iv) Policies, procedures, equipment necessary to perform duties as expected, minimally including:
      - (A) Actions during emergencies;
      - (B) Actions related to suspected, or alleged abuse, neglect, or accidents involving residents; and
      - (C) Methods of preventing transmission of infection.

(2) Boarding homes shall require and have:

- (a) Staff with resident care duties possessing:
  - (i) Current first aid cards, unless licensed nurses, from instructors certified by:
    - (A) American Red Cross; or
    - (B) American Heart Association; or
    - (C) United States Bureau of Mines; or
    - (D) Washington state department of labor and industries.
  - (ii) Current cardiopulmonary resuscitation cards from instructors certified as in subsection (2)(a)(i)(A), (B), (C), and (D) of this section.

(b) ~~(A written statement from all staff and persons other than residents living or working in a boarding home regarding:~~

- ~~(i) Convictions for felony;~~
- ~~(ii) Convictions for crimes involving physical harm to another; and~~

~~((iii)) Previous perpetrator of substantiated abuse as described in chapter 26.44 RCW.~~

~~((c))~~ Exclusion of persons other than residents from living or working on the premises when evidence indicates previous conviction or abuse, as in subsection (2)(b) of this section, unless the boarding home licensee:

(i) Determines such person is rehabilitated enough to warrant public trust; and

(ii) Records the facts and basis for decision.

(3) Boarding homes shall reassign and/or restrict staff contact with residents when:

(a) Staff have a known communicable disease in the infectious stage; and

(b) The disease is likely to be spread in the boarding home setting or by casual contact.

(4) Boarding homes shall maintain documentation of:

~~((a))~~ Staff orientation and training pertinent to duties, including cardiopulmonary resuscitation and first aid if required in subsection (2)(a) of this section;~~and~~

~~((b)) Individual staff statements related to conviction or abuse and related boarding home actions as required in subsection (2)(b) and (c) of this section).~~

AMENDATORY SECTION (Amending Order 224, filed 12/23/91, effective 1/23/92)

WAC 246-318-040 PERSONNEL. (1) Hospitals shall employ sufficient qualified personnel to operate each department of the hospital with verification of required license, certification, or registration.

(2) Hospitals shall ensure that nonemployees providing direct patient care comply with hospital policies and procedures.

(3) Hospitals shall establish written job descriptions for each job classification, minimally including:

(a) Job title, reporting relationships, summary of duties and responsibilities, and qualifications; and

(b) Provisions for review every two years with revision when necessary.

(4) Hospitals shall:

(a) Ensure a periodic performance appraisal of employees and volunteers related to:

(i) Satisfactory performance of assigned tasks; and

(ii) Competence in delivering health care services;

~~(b) ((Document background checks required under RCW 43.43.830 through 43.43.842 for all prospective employees and volunteers who may have regularly scheduled unsupervised access to:~~

~~((i)) Children under sixteen years of age;~~

~~((ii)) Groups of children under certain circumstances;~~

~~((iii)) The elderly;~~

~~((iv)) The developmentally disabled;~~

~~((v)) Individuals declared mentally incompetent or unable to participate in consent to care given; and~~

~~((vi)) Others as required under chapter 43.43 RCW;~~

~~((c))~~ Designate an employee responsible for volunteer services and activities;

~~((d))~~ ~~((c))~~ Plan and implement orientation and education programs minimally to include:

(i) New employee and volunteer orientation for:

(A) Organizational structure;

(B) Building layout;

(C) Infection control;

(D) Safety, including the fire and disaster plan;

(E) Policies and procedures; and

(F) Equipment pertinent to the job;

(ii) Employee continuing education for maintaining and improving skills;

(iii) Documentation of orientation, in-service, and continuing education for employees; and

(iv) HIV/AIDS training for employees as specified under WAC 246-318-035;

~~((e))~~ ~~((d))~~ Establish a nursing service under the direction of a registered nurse to:

(i) Provide for adequate numbers of registered nurses on duty at all times; and

(ii) Require registered nurse supervision of employees and others performing nursing service functions;

~~((f))~~ ~~((e))~~ Ensure adequate supervision of employees and nonemployees;

~~((g))~~ ~~((f))~~ Maintain a current employee call back list for disasters;

~~((h))~~ ~~((g))~~ Require each employee to have on employment a tuberculin skin test by the Mantoux method within thirty days of employment and as follows:

(i) For new employees, a negative skin test is defined as less than ten millimeters of induration read at forty-eight to seventy-two hours. Employees with negative reactions to the first test and thirty-five years of age or older shall have a second test one to three weeks after the first test;

(ii) New employees with positive reactions to either test shall have a chest x-ray within thirty days. Hospitals shall:

(A) Retain records of test results, reports of x-ray findings, exceptions, or exemptions in the facility; and

(B) Provide a copy of test results to the employee;

(iii) Exclude from skin testing:

(A) New employees documenting a positive Mantoux test in the past;

(B) New employees providing documentation of meeting requirements under subsection (4)(h)(i) and (ii) of this section within the six months preceding the date of employment; and

(C) An employee with a written waiver from the department after stating the tuberculin skin test by the Mantoux method presents a hazard to his or her health and presenting supportive medical data to the department tuberculosis control program;

~~((i))~~ ~~((h))~~ Document the following when individuals request tuberculosis skin test waivers from the department:

(i) Department notification of the individual requesting a waiver from tuberculosis skin testing and department decision; and

(ii) Department advice to the individual employee and the hospital regarding department screening requirements if a waiver is granted.

#### NEW SECTION

WAC 246-318-042 CRIMINAL HISTORY, DISCLOSURE, AND BACKGROUND INQUIRIES. (1) Licensees or license applicants shall require disclosure statements as specified under RCW 43.43.830 through 43.43.842 for all prospective employees, volunteers, contractors, and students who may have unsupervised direct contact with:

(a) Children under sixteen years of age;

(b) Vulnerable adults as defined under RCW 43.43.830;

(c) Developmentally disabled individuals.

(2) Except as provided in RCW 43.43.842 and in subsection (3) of this section, licensees shall:

(a) Ensure background inquiries are completed on all prospective employees and volunteers having direct contact with vulnerable adults;

(b) Not hire or retain, directly or by contract, any employee, volunteer, or student, having direct contact with vulnerable adults, who was:

(i) Convicted of a crime against persons as defined in RCW 43.43.830;

(ii) Convicted of crimes relating to financial exploitation of a vulnerable adult as defined in RCW 43.43.830;

(iii) Found in any disciplinary board final decision to have abused a vulnerable adult under RCW 43.43.830; or

(iv) The subject in a protective proceeding under chapter 74.34 RCW.

(3) A licensee may conditionally employ, contract with or accept as a volunteer, an individual pending a background inquiry, provided, the licensee requests the inquiry within three business days of the conditional acceptance of the individual.

(4) Licensees shall, before employing directly or by contract, or accepting any person as a volunteer or student having direct contact with a vulnerable adult:

(a) Inform the prospective employee, contractor, volunteer, or student of the requirement for a background inquiry under RCW 43.43.830 through 43.43.842;

(b) Require a person to sign an acknowledgement statement that a background inquiry will be made;

(c) Verbally inform the person of the background inquiry results within seventy-two hours of receipt; and

(d) Offer to provide a copy of the background inquiry results to the prospective employee, contractor, volunteer, or student (within ten days of receipt).

(5) Licensees shall:

(a) Require all current employees, contractors, volunteers, and students engaged on or after July 22, 1989, to sign disclosure statements; and

(b) Ensure background inquiries are conducted on all individuals identified in (a) of this subsection having direct contact with vulnerable adults.

(6) The licensee shall establish and implement procedures ensuring:

(a) All disclosure statements and background inquiry responses are maintained in a confidential and secure manner;

(b) Disclosure statements and background inquiry responses are used for employment purposes only;

(c) Disclosure statements and background inquiry responses are not disclosed to any person except:

(i) The person about whom the licensee made the disclosure or background inquiry;

(ii) Authorized state and federal employees; and

(iii) The Washington state patrol auditor; and

(d) A record of findings are retained during and at least two years following termination of employment.

(7) The department shall:

(a) Conduct background inquiries specified under RCW 43.43.830 on all licensees or license applicants who can financially exploit or have direct contact with vulnerable adults;

(b) Notify the licensee or license applicant of the results of the background inquiry;

(c) Review records required under this section;

(d) Investigate allegations of noncompliance with RCW 43.43.830 through 43.43.842, when necessary, in consultation with law enforcement personnel; and

(e) Use information collected under this section solely for the purpose of determining eligibility for licensure or relicensure as required under RCW 43.43.842.

(8) The department may require that licensees complete additional disclosure statements or background inquiries for employees, contractors, volunteers, or students, if the department has reason to believe that offenses specified under RCW 43.43.830 have occurred since completion of the original disclosure statement or background inquiry.

#### NEW SECTION

WAC 246-321-018 CRIMINAL HISTORY, DISCLOSURE, AND BACKGROUND INQUIRIES. (1) Licensees or license applicants shall require disclosure statements as specified under RCW 43.43.830 through 43.43.842 for all prospective employees, volunteers, contractors, and students who may have unsupervised direct contact with:

(a) Children under sixteen years of age;

(b) Vulnerable adults as defined under RCW 43.43.830;

(c) Developmentally disabled individuals.

(2) Except as provided in RCW 43.43.842 and in subsection (3) of this section, licensees shall:

(a) Ensure background inquiries are completed on all prospective employees and volunteers having direct contact with vulnerable adults;

(b) Not hire or retain, directly or by contract, any employee, volunteer, or student, having direct contact with vulnerable adults, who was:

(i) Convicted of a crime against persons as defined in RCW 43.43.830;

(ii) Convicted of crimes relating to financial exploitation of a vulnerable adult as defined in RCW 43.43.830;

(iii) Found in any disciplinary board final decision to have abused a vulnerable adult under RCW 43.43.830; or

(iv) The subject in a protective proceeding under chapter 74.34 RCW.

(3) A licensee may conditionally employ, contract with or accept as a volunteer, an individual pending a background inquiry, provided, the licensee requests the inquiry within three business days of the conditional acceptance of the individual.

(4) Licensees shall, before employing directly or by contract, or accepting any person as a volunteer or student having direct contact with a vulnerable adult:

(a) Inform the prospective employee, contractor, volunteer, or student of the requirement for a background inquiry under RCW 43.43.830 through 43.43.842;

(b) Require a person to sign an acknowledgement statement that a background inquiry will be made;

(c) Verbally inform the person of the background inquiry results within seventy-two hours of receipt; and

(d) Offer to provide a copy of the background inquiry results to the prospective employee, contractor, volunteer, or student (within ten days of receipt).

(5) Licensees shall:

(a) Require all current employees, contractors, volunteers, and students engaged on or after July 22, 1989, to sign disclosure statements; and

(b) Ensure background inquiries are conducted on all individuals identified in (a) of this subsection having direct contact with vulnerable adults.

(6) The licensee shall establish and implement procedures ensuring:

(a) All disclosure statements and background inquiry responses are maintained in a confidential and secure manner;

(b) Disclosure statements and background inquiry responses are used for employment purposes only;

(c) Disclosure statements and background inquiry responses are not disclosed to any person except:

(i) The person about whom the licensee made the disclosure or background inquiry;

(ii) Authorized state and federal employees; and

(iii) The Washington state patrol auditor; and

(d) A record of findings are retained during and at least two years following termination of employment.

(7) The department shall:

(a) Conduct background inquiries specified under RCW 43.43.830 on all licensees or license applicants who can financially exploit or have direct contact with vulnerable adults;

(b) Notify the licensee or license applicant of the results of the background inquiry;

(c) Review records required under this section;

(d) Investigate allegations of noncompliance with RCW 43.43.830 through 43.43.842, when necessary, in consultation with law enforcement personnel; and

(e) Use information collected under this section solely for the purpose of determining eligibility for licensure or relicensure as required under RCW 43.43.842.

(8) The department may require that licensees complete additional disclosure statements or background inquiries for employees, contractors, volunteers, or students, if the department has reason to believe that offenses specified under RCW 43.43.830 have occurred since completion of the original disclosure statement or background inquiry.

#### NEW SECTION

WAC 246-323-022 CRIMINAL HISTORY, DISCLOSURE, AND BACKGROUND INQUIRIES. (1) Licensees or license applicants shall require disclosure statements as specified under RCW 43.43.830 through 43.43.842 for all prospective employees, volunteers, contractors, and students who may have unsupervised direct contact with:

(a) Children under sixteen years of age;

(b) Vulnerable adults as defined under RCW 43.43.830;

(c) Developmentally disabled individuals.

(2) Except as provided in RCW 43.43.842 and in subsection (3) of this section, licensees shall:

(a) Ensure background inquiries are completed on all prospective employees and volunteers having direct contact with vulnerable adults;

(b) Not hire or retain, directly or by contract, any employee, volunteer, or student, having direct contact with vulnerable adults, who was:

(i) Convicted of a crime against persons as defined in RCW 43.43.830;

(ii) Convicted of crimes relating to financial exploitation of a vulnerable adult as defined in RCW 43.43.830;

(iii) Found in any disciplinary board final decision to have abused a vulnerable adult under RCW 43.43.830; or

(iv) The subject in a protective proceeding under chapter 74.34 RCW.

(3) A licensee may conditionally employ, contract with, or accept as a volunteer an individual pending a background inquiry, provided, the licensee requests the inquiry within three business days of the conditional acceptance of the individual.

(4) Licensees shall, before employing directly or by contract, or accepting any person as a volunteer or student having direct contact with a vulnerable adult:

(a) Inform the prospective employee, contractor, volunteer, or student of the requirement for a background inquiry under RCW 43.43.830 through 43.43.842;

(b) Require a person to sign an acknowledgement statement that a background inquiry will be made;

(c) Verbally inform the person of the background inquiry results within seventy-two hours of receipt; and

(d) Offer to provide a copy of the background inquiry results to the prospective employee, contractor, volunteer, or student (within ten days of receipt).

(5) Licensees shall:

(a) Require all current employees, contractors, volunteers, and students engaged on or after July 22, 1989, to sign disclosure statements; and

(b) Ensure background inquiries are conducted on all individuals identified in (a) of this subsection having direct contact with vulnerable adults.

(6) The licensee shall establish and implement procedures ensuring:

(a) All disclosure statements and background inquiry responses are maintained in a confidential and secure manner;

(b) Disclosure statements and background inquiry responses are used for employment purposes only;

(c) Disclosure statements and background inquiry responses are not disclosed to any person except:

(i) The person about whom the licensee made the disclosure or background inquiry;

(ii) Authorized state and federal employees; and

(iii) The Washington state patrol auditor; and

(d) A record of findings are retained during and at least two years following termination of employment.

(7) The department shall:

(a) Conduct background inquiries specified under RCW 43.43.830 on all licensees or license applicants who can financially exploit or have direct contact with vulnerable adults;

(b) Notify the licensee or license applicant of the results of the background inquiry;

(c) Review records required under this section;

(d) Investigate allegations of noncompliance with RCW 43.43.830 through 43.43.842, when necessary, in consultation with law enforcement personnel; and

(e) Use information collected under this section solely for the purpose of determining eligibility for licensure or relicensure as required under RCW 43.43.842.

(8) The department may require that licensees complete additional disclosure statements or background inquiries for employees, contractors, volunteers, or students, if the department has reason to believe that offenses specified under RCW 43.43.830 have occurred since completion of the original disclosure statement or background inquiry.

#### NEW SECTION

WAC 246-325-022 CRIMINAL HISTORY, DISCLOSURE, AND BACKGROUND INQUIRIES. (1) Licensees or license applicants shall require disclosure statements as specified under RCW 43.43.830 through 43.43.842 for all prospective employees, volunteers, contractors, and students who may have unsupervised direct contact with:

(a) Children under sixteen years of age;

(b) Vulnerable adults as defined under RCW 43.43.830;

(c) Developmentally disabled individuals.

(2) Except as provided in RCW 43.43.842 and in subsection (3) of this section, licensees shall:

(a) Ensure background inquiries are completed on all prospective employees and volunteers having direct contact with vulnerable adults;

(b) Not hire or retain, directly or by contract, any employee, volunteer, or student, having direct contact with vulnerable adults, who was:

(i) Convicted of a crime against persons as defined in RCW 43.43.830;

(ii) Convicted of crimes relating to financial exploitation of a vulnerable adult as defined in RCW 43.43.830;

(iii) Found in any disciplinary board final decision to have abused a vulnerable adult under RCW 43.43.830; or

(iv) The subject in a protective proceeding under chapter 74.34 RCW.

(3) A licensee may conditionally employ, contract with or accept as a volunteer, an individual pending a background inquiry, provided, the licensee requests the inquiry within three business days of the conditional acceptance of the individual.

(4) Licensees shall, before employing directly or by contract, or accepting any person as a volunteer or student having direct contact with a vulnerable adult:

(a) Inform the prospective employee, contractor, volunteer, or student of the requirement for a background inquiry under RCW 43.43.830 through 43.43.842;

(b) Require a person to sign an acknowledgement statement that a background inquiry will be made;

(c) Verbally inform the person of the background inquiry results within seventy-two hours of receipt; and

(d) Offer to provide a copy of the background inquiry results to the prospective employee, contractor, volunteer, or student (within ten days of receipt).

(5) Licensees shall:

(a) Require all current employees, contractors, volunteers, and students engaged on or after July 22, 1989, to sign disclosure statements; and

(b) Ensure background inquiries are conducted on all individuals identified in (a) of this subsection having direct contact with vulnerable adults.

(6) The licensee shall establish and implement procedures ensuring:

(a) All disclosure statements and background inquiry responses are maintained in a confidential and secure manner;

(b) Disclosure statements and background inquiry responses are used for employment purposes only;

(c) Disclosure statements and background inquiry responses are not disclosed to any person except:

(i) The person about whom the licensee made the disclosure or background inquiry;

(ii) Authorized state and federal employees; and

(iii) The Washington state patrol auditor; and

(d) A record of findings are retained during and at least two years following termination of employment.

(7) The department shall:

(a) Conduct background inquiries specified under RCW 43.43.830 on all licensees or license applicants who can financially exploit or have direct contact with vulnerable adults;

(b) Notify the licensee or license applicant of the results of the background inquiry;

(c) Review records required under this section;

(d) Investigate allegations of noncompliance with RCW 43.43.830 through 43.43.842, when necessary, in consultation with law enforcement personnel; and

(e) Use information collected under this section solely for the purpose of determining eligibility for licensure or relicensure as required under RCW 43.43.842.

(8) The department may require that licensees complete additional disclosure statements or background inquiries for employees, contractors, volunteers, or students, if the department has reason to believe that offenses specified under RCW 43.43.830 have occurred since completion of the original disclosure statement or background inquiry.

#### NEW SECTION

WAC 246-327-090 CRIMINAL HISTORY, DISCLOSURE, AND BACKGROUND INQUIRIES. (1) Licensees or license applicants shall require disclosure statements as specified under RCW 43.43.830 through 43.43.842 for all prospective employees, volunteers, contractors, and students who may have unsupervised direct contact with:

(a) Children under sixteen years of age;

(b) Vulnerable adults as defined under RCW 43.43.830;

(c) Developmentally disabled individuals.

(2) Except as provided in RCW 43.43.842 and in subsection (3) of this section, licensees shall:

(a) Ensure background inquiries are completed on all prospective employees and volunteers having direct contact with vulnerable adults;

(b) Not hire or retain, directly or by contract, any employee, volunteer, or student, having direct contact with vulnerable adults, who was:

(i) Convicted of a crime against persons as defined in RCW 43.43.830;

(ii) Convicted of crimes relating to financial exploitation of a vulnerable adult as defined in RCW 43.43.830;

(iii) Found in any disciplinary board final decision to have abused a vulnerable adult under RCW 43.43.830; or

(iv) The subject in a protective proceeding under chapter 74.34 RCW.

(3) A licensee may conditionally employ, contract with or accept as a volunteer, an individual pending a background inquiry, provided, the licensee requests the inquiry within three business days of the conditional acceptance of the individual.

(4) Licensees shall, before employing directly or by contract, or accepting any person as a volunteer or student having direct contact with a vulnerable adult:

- (a) Inform the prospective employee, contractor, volunteer, or student of the requirement for a background inquiry under RCW 43.43.830 through 43.43.842;
- (b) Require a person to sign an acknowledgement statement that a background inquiry will be made;
- (c) Verbally inform the person of the background inquiry results within seventy-two hours of receipt; and
- (d) Offer to provide a copy of the background inquiry results to the prospective employee, contractor, volunteer, or student (within ten days of receipt).
- (5) Licensees shall:
  - (a) Require all current employees, contractors, volunteers, and students engaged on or after July 22, 1989, to sign disclosure statements; and
  - (b) Ensure background inquiries are conducted on all individuals identified in (a) of this subsection having direct contact with vulnerable adults.
  - (6) The licensee shall establish and implement procedures ensuring:
    - (a) All disclosure statements and background inquiry responses are maintained in a confidential and secure manner;
    - (b) Disclosure statements and background inquiry responses are used for employment purposes only;
    - (c) Disclosure statements and background inquiry responses are not disclosed to any person except:
      - (i) The person about whom the licensee made the disclosure or background inquiry;
      - (ii) Authorized state and federal employees; and
      - (iii) The Washington state patrol auditor; and
      - (d) A record of findings are retained during and at least two years following termination of employment.
  - (7) The department shall:
    - (a) Conduct background inquiries specified under RCW 43.43.830 on all licensees or license applicants who can financially exploit or have direct contact with vulnerable adults;
    - (b) Notify the licensee or license applicant of the results of the background inquiry;
    - (c) Review records required under this section;
    - (d) Investigate allegations of noncompliance with RCW 43.43.830 through 43.43.842, when necessary, in consultation with law enforcement personnel; and
    - (e) Use information collected under this section solely for the purpose of determining eligibility for licensure or relicensure as required under RCW 43.43.842.
  - (8) The department may require that licensees complete additional disclosure statements or background inquiries for employees, contractors, volunteers, or students, if the department has reason to believe that offenses specified under RCW 43.43.830 have occurred since completion of the original disclosure statement or background inquiry.

**NEW SECTION**

WAC 246-329-035 CRIMINAL HISTORY, DISCLOSURE, AND BACKGROUND INQUIRIES. (1) Licensees or license applicants shall require disclosure statements as specified under RCW 43.43.830 through 43.43.842 for all prospective employees, volunteers, contractors, and students who may have unsupervised direct contact with:

- (a) Children under sixteen years of age;
- (b) Vulnerable adults as defined under RCW 43.43.830;
- (c) Developmentally disabled individuals.

(2) Except as provided in RCW 43.43.842 and in subsection (3) of this section, licensees shall:

- (a) Ensure background inquiries are completed on all prospective employees and volunteers having direct contact with vulnerable adults;
- (b) Not hire or retain, directly or by contract, any employee, volunteer, or student, having direct contact with vulnerable adults, who was:
  - (i) Convicted of a crime against persons as defined in RCW 43.43.830;
  - (ii) Convicted of crimes relating to financial exploitation of a vulnerable adult as defined in RCW 43.43.830;
  - (iii) Found in any disciplinary board final decision to have abused a vulnerable adult under RCW 43.43.830; or
  - (iv) The subject in a protective proceeding under chapter 74.34 RCW.
- (3) A licensee may conditionally employ, contract with or accept as a volunteer, an individual pending a background inquiry, provided, the licensee requests the inquiry within three business days of the conditional acceptance of the individual.

- (4) Licensees shall, before employing directly or by contract, or accepting any person as a volunteer or student having direct contact with a vulnerable adult:
  - (a) Inform the prospective employee, contractor, volunteer, or student of the requirement for a background inquiry under RCW 43.43.830 through 43.43.842;
  - (b) Require a person to sign an acknowledgement statement that a background inquiry will be made;
  - (c) Verbally inform the person of the background inquiry results within seventy-two hours of receipt; and
  - (d) Offer to provide a copy of the background inquiry results to the prospective employee, contractor, volunteer, or student (within ten days of receipt).
  - (5) Licensees shall:
    - (a) Require all current employees, contractors, volunteers, and students engaged on or after July 22, 1989, to sign disclosure statements; and
    - (b) Ensure background inquiries are conducted on all individuals identified in (a) of this subsection having direct contact with vulnerable adults.
    - (6) The licensee shall establish and implement procedures ensuring:
      - (a) All disclosure statements and background inquiry responses are maintained in a confidential and secure manner;
      - (b) Disclosure statements and background inquiry responses are used for employment purposes only;
      - (c) Disclosure statements and background inquiry responses are not disclosed to any person except:
        - (i) The person about whom the licensee made the disclosure or background inquiry;
        - (ii) Authorized state and federal employees; and
        - (iii) The Washington state patrol auditor; and
        - (d) A record of findings are retained during and at least two years following termination of employment.
    - (7) The department shall:
      - (a) Conduct background inquiries specified under RCW 43.43.830 on all licensees or license applicants who can financially exploit or have direct contact with vulnerable adults;
      - (b) Notify the licensee or license applicant of the results of the background inquiry;
      - (c) Review records required under this section;
      - (d) Investigate allegations of noncompliance with RCW 43.43.830 through 43.43.842, when necessary, in consultation with law enforcement personnel; and
      - (e) Use information collected under this section solely for the purpose of determining eligibility for licensure or relicensure as required under RCW 43.43.842.
    - (8) The department may require that licensees complete additional disclosure statements or background inquiries for employees, contractors, volunteers, or students, if the department has reason to believe that offenses specified under RCW 43.43.830 have occurred since completion of the original disclosure statement or background inquiry.

**NEW SECTION**

WAC 246-331-100 CRIMINAL HISTORY, DISCLOSURE, AND BACKGROUND INQUIRIES. (1) Licensees or license applicants shall require disclosure statements as specified under RCW 43.43.830 through 43.43.842 for all prospective employees, volunteers, contractors, and students who may have unsupervised direct contact with:

- (a) Children under sixteen years of age;
- (b) Vulnerable adults as defined under RCW 43.43.830;
- (c) Developmentally disabled individuals.

(2) Except as provided in RCW 43.43.842 and in subsection (3) of this section, licensees shall:

- (a) Ensure background inquiries are completed on all prospective employees and volunteers having direct contact with vulnerable adults;
- (b) Not hire or retain, directly or by contract, any employee, volunteer, or student, having direct contact with vulnerable adults, who was:
  - (i) Convicted of a crime against persons as defined in RCW 43.43.830;
  - (ii) Convicted of crimes relating to financial exploitation of a vulnerable adult as defined in RCW 43.43.830;
  - (iii) Found in any disciplinary board final decision to have abused a vulnerable adult under RCW 43.43.830; or
  - (iv) The subject in a protective proceeding under chapter 74.34 RCW.

(3) A licensee may conditionally employ, contract with or accept as a volunteer, an individual pending a background inquiry, provided, the licensee requests the inquiry within three business days of the conditional acceptance of the individual.

(4) Licensees shall, before employing directly or by contract, or accepting any person as a volunteer or student having direct contact with a vulnerable adult:

(a) Inform the prospective employee, contractor, volunteer, or student of the requirement for a background inquiry under RCW 43.43.830 through 43.43.842;

(b) Require a person to sign an acknowledgement statement that a background inquiry will be made;

(c) Verbally inform the person of the background inquiry results within seventy-two hours of receipt; and

(d) Offer to provide a copy of the background inquiry results to the prospective employee, contractor, volunteer, or student (within ten days of receipt).

(5) Licensees shall:

(a) Require all current employees, contractors, volunteers, and students engaged on or after July 22, 1989, to sign disclosure statements; and

(b) Ensure background inquiries are conducted on all individuals identified in (a) of this subsection having direct contact with vulnerable adults.

(6) The licensee shall establish and implement procedures ensuring:

(a) All disclosure statements and background inquiry responses are maintained in a confidential and secure manner;

(b) Disclosure statements and background inquiry responses are used for employment purposes only;

(c) Disclosure statements and background inquiry responses are not disclosed to any person except:

(i) The person about whom the licensee made the disclosure or background inquiry;

(ii) Authorized state and federal employees; and

(iii) The Washington state patrol auditor; and

(d) A record of findings are retained during and at least two years following termination of employment.

(7) The department shall:

(a) Conduct background inquiries specified under RCW 43.43.830 on all licensees or license applicants who can financially exploit or have direct contact with vulnerable adults;

(b) Notify the licensee or license applicant of the results of the background inquiry;

(c) Review records required under this section;

(d) Investigate allegations of noncompliance with RCW 43.43.830 through 43.43.842, when necessary, in consultation with law enforcement personnel; and

(e) Use information collected under this section solely for the purpose of determining eligibility for licensure or relicensure as required under RCW 43.43.842.

(8) The department may require that licensees complete additional disclosure statements or background inquiries for employees, contractors, volunteers, or students, if the department has reason to believe that offenses specified under RCW 43.43.830 have occurred since completion of the original disclosure statement or background inquiry.

#### NEW SECTION

WAC 246-336-100 CRIMINAL HISTORY, DISCLOSURE, AND BACKGROUND INQUIRIES. (1) Licensees or license applicants shall require disclosure statements as specified under RCW 43.43.830 through 43.43.842 for all prospective employees, volunteers, contractors, and students who may have unsupervised direct contact with:

(a) Children under sixteen years of age;

(b) Vulnerable adults as defined under RCW 43.43.830;

(c) Developmentally disabled individuals.

(2) Except as provided in RCW 43.43.842 and in subsection (3) of this section, licensees shall:

(a) Ensure background inquiries are completed on all prospective employees and volunteers having direct contact with vulnerable adults;

(b) Not hire or retain, directly or by contract, any employee, volunteer, or student, having direct contact with vulnerable adults, who was:

(i) Convicted of a crime against persons as defined in RCW 43.43.830;

(ii) Convicted of crimes relating to financial exploitation of a vulnerable adult as defined in RCW 43.43.830;

(iii) Found in any disciplinary board final decision to have abused a vulnerable adult under RCW 43.43.830; or

(iv) The subject in a protective proceeding under chapter 74.34 RCW.

(3) A licensee may conditionally employ, contract with or accept as a volunteer, an individual pending a background inquiry, provided, the licensee requests the inquiry within three business days of the conditional acceptance of the individual.

(4) Licensees shall, before employing directly or by contract, or accepting any person as a volunteer or student having direct contact with a vulnerable adult:

(a) Inform the prospective employee, contractor, volunteer, or student of the requirement for a background inquiry under RCW 43.43.830 through 43.43.842;

(b) Require a person to sign an acknowledgement statement that a background inquiry will be made;

(c) Verbally inform the person of the background inquiry results within seventy-two hours of receipt; and

(d) Offer to provide a copy of the background inquiry results to the prospective employee, contractor, volunteer, or student (within ten days of receipt).

(5) Licensees shall:

(a) Require all current employees, contractors, volunteers, and students engaged on or after July 22, 1989, to sign disclosure statements; and

(b) Ensure background inquiries are conducted on all individuals identified in (a) of this subsection having direct contact with vulnerable adults.

(6) The licensee shall establish and implement procedures ensuring:

(a) All disclosure statements and background inquiry responses are maintained in a confidential and secure manner;

(b) Disclosure statements and background inquiry responses are used for employment purposes only;

(c) Disclosure statements and background inquiry responses are not disclosed to any person except:

(i) The person about whom the licensee made the disclosure or background inquiry;

(ii) Authorized state and federal employees; and

(iii) The Washington state patrol auditor; and

(d) A record of findings are retained during and at least two years following termination of employment.

(7) The department shall:

(a) Conduct background inquiries specified under RCW 43.43.830 on all licensees or license applicants who can financially exploit or have direct contact with vulnerable adults;

(b) Notify the licensee or license applicant of the results of the background inquiry;

(c) Review records required under this section;

(d) Investigate allegations of noncompliance with RCW 43.43.830 through 43.43.842, when necessary, in consultation with law enforcement personnel; and

(e) Use information collected under this section solely for the purpose of determining eligibility for licensure or relicensure as required under RCW 43.43.842.

(8) The department may require that licensees complete additional disclosure statements or background inquiries for employees, contractors, volunteers, or students, if the department has reason to believe that offenses specified under RCW 43.43.830 have occurred since completion of the original disclosure statement or background inquiry.

#### NEW SECTION

WAC 246-340-085 CRIMINAL HISTORY, DISCLOSURE, AND BACKGROUND INQUIRIES. (1) Licensees or license applicants shall require disclosure statements as specified under RCW 43.43.830 through 43.43.842 for all prospective employees, volunteers, contractors, and students who may have unsupervised direct contact with:

(a) Children under sixteen years of age;

(b) Vulnerable adults as defined under RCW 43.43.830;

(c) Developmentally disabled individuals.

(2) Except as provided in RCW 43.43.842 and in subsection (3) of this section, licensees shall:

(a) Ensure background inquiries are completed on all prospective employees and volunteers having direct contact with vulnerable adults;

(b) Not hire or retain, directly or by contract, any employee, volunteer, or student, having direct contact with vulnerable adults, who was:



(i) Convicted of a crime against persons as defined in RCW 43.43.830;

(ii) Convicted of crimes relating to financial exploitation of a vulnerable adult as defined in RCW 43.43.830;

(iii) Found in any disciplinary board final decision to have abused a vulnerable adult under RCW 43.43.830; or

(iv) The subject in a protective proceeding under chapter 74.34 RCW.

(3) A licensee may conditionally employ, contract with or accept as a volunteer, an individual pending a background inquiry, provided, the licensee requests the inquiry within three business days of the conditional acceptance of the individual.

(4) Licensees shall, before employing directly or by contract, or accepting any person as a volunteer or student having direct contact with a vulnerable adult:

(a) Inform the prospective employee, contractor, volunteer, or student of the requirement for a background inquiry under RCW 43.43.830 through 43.43.842;

(b) Require a person to sign an acknowledgement statement that a background inquiry will be made;

(c) Verbally inform the person of the background inquiry results within seventy-two hours of receipt; and

(d) Offer to provide a copy of the background inquiry results to the prospective employee, contractor, volunteer, or student (within ten days of receipt).

(5) Licensees shall:

(a) Require all current employees, contractors, volunteers, and students engaged on or after July 22, 1989, to sign disclosure statements; and

(b) Ensure background inquiries are conducted on all individuals identified in (a) of this subsection having direct contact with vulnerable adults.

(6) The licensee shall establish and implement procedures ensuring:

(a) All disclosure statements and background inquiry responses are maintained in a confidential and secure manner;

(b) Disclosure statements and background inquiry responses are used for employment purposes only;

(c) Disclosure statements and background inquiry responses are not disclosed to any person except:

(i) The person about whom the licensee made the disclosure or background inquiry;

(ii) Authorized state and federal employees; and

(iii) The Washington state patrol auditor; and

(d) A record of findings are retained during and at least two years following termination of employment.

(7) The department shall:

(a) Conduct background inquiries specified under RCW 43.43.830 on all licensees or license applicants who can financially exploit or have direct contact with vulnerable adults;

(b) Notify the licensee or license applicant of the results of the background inquiry;

(c) Review records required under this section;

(d) Investigate allegations of noncompliance with RCW 43.43.830 through 43.43.842, when necessary, in consultation with law enforcement personnel; and

(e) Use information collected under this section solely for the purpose of determining eligibility for licensure or relicensure as required under RCW 43.43.842.

(8) The department may require that licensees complete additional disclosure statements or background inquiries for employees, contractors, volunteers, or students, if the department has reason to believe that offenses specified under RCW 43.43.830 have occurred since completion of the original disclosure statement or background inquiry.

#### AMENDATORY SECTION (Amending Order 224, filed 12/23/91, effective 1/23/92)

WAC 246-388-070 PERSONNEL. (1) Rural health care facilities shall employ qualified personnel with verification of required license, certification, or registration.

(2) Rural health care facilities shall establish personnel policies requiring:

(a) Written job descriptions for each job classification including job title, reporting relationships, summary of duties and responsibilities, and qualifications;

(b) Provisions for review every two years, with revision as necessary;

(c) Periodic performance evaluation of:

(i) All employees; and

(ii) Volunteers providing direct patient care;

~~(d) ((Documented background checks as required under RCW 43.43.830 through 43.43.842 for all prospective employees and volunteers who may have regularly scheduled unsupervised access to patients;~~

~~(e)) Coordination and supervision of volunteer services and activities by a designated employee of the rural health care facility;~~

~~((f)) (e) Orientation and education programs for employees and volunteers including:~~

~~(i) Purpose and organizational structure;~~

~~(ii) Location and layout of the rural health care facility;~~

~~(iii) Infection control;~~

~~(iv) Safety;~~

~~(v) Policies and procedures; and~~

~~(vi) Equipment pertinent to the job;~~

~~((g)) (f) Continuing education for maintaining skills for personnel and volunteers providing direct patient care;~~

~~((h)) (g) Documentation of orientation, in-service, and continuing education; and~~

~~((i)) (h) HIV/AIDS education of employees and volunteers including:~~

~~(i) Verifying or arranging for appropriate education and training on prevention, transmission, and treatment of HIV and AIDS consistent with RCW 70.24.310; and~~

~~(ii) Use of infection control standards and educational materials consistent with the department-approved manual KNOW-HIV/AIDS Prevention Education for Health Care Facility Employees, January 1991, office on HIV/AIDS.~~

(3) Rural health care facilities shall:

(a) Provide nursing staff on duty necessary to take care of inpatients with an on-call system when inpatients are not present;

(b) Require medical staff or registered nurse supervision of nonemployees and others performing patient care functions;

(c) Maintain an employee callback list for use in the event of disaster;

(d) Require individuals to remain off duty if they have a known communicable disease in an infectious stage when transmission to patients is probable during performance of assigned work duties;

(e) Require each employee and volunteer to have a tuberculin skin test by the Mantoux method within one week of serving with the rural health care facility, and as follows:

(i) A negative skin test defined as less than ten millimeters of induration read at forty-eight to seventy-two hours;

(ii) Negative reactors to the first test who are thirty-five years of age or older are required to have a second test one to three weeks after the first test;

(iii) Positive reactors to either test are required to have a chest x-ray within thirty days;

(iv) A record of test results, reports of x-ray findings, or exceptions to such kept in the facility;

(v) A copy of the record in (e)(iv) of this subsection supplied to the individual;

(vi) Exceptions including:

(A) Exclusion of new persons from screening if documenting a positive Mantoux test in the past; and

(B) Exclusion of an employee with a written waiver from the department tuberculosis control program after stating the tuberculin skin test by the Mantoux method presents a hazard to his or her health and presenting supportive medical data to the department tuberculosis control program.

#### NEW SECTION

WAC 246-388-072 CRIMINAL HISTORY, DISCLOSURE, AND BACKGROUND INQUIRIES. (1) Licensees or license applicants shall require disclosure statements as specified under RCW 43.43.830 through 43.43.842 for all prospective employees, volunteers, contractors, and students who may have unsupervised direct contact with:

(a) Children under sixteen years of age;

(b) Vulnerable adults as defined under RCW 43.43.830;

(c) Developmentally disabled individuals.

(2) Except as provided in RCW 43.43.842 and in subsection (3) of this section, licensees shall:

(a) Ensure background inquiries are completed on all prospective employees and volunteers having direct contact with vulnerable adults;

(b) Not hire or retain, directly or by contract, any employee, volunteer, or student, having direct contact with vulnerable adults, who was:



(i) Convicted of a crime against persons as defined in RCW 43.43.830;

(ii) Convicted of crimes relating to financial exploitation of a vulnerable adult as defined in RCW 43.43.830;

(iii) Found in any disciplinary board final decision to have abused a vulnerable adult under RCW 43.43.830; or

(iv) The subject in a protective proceeding under chapter 74.34 RCW.

(3) A licensee may conditionally employ, contract with or accept as a volunteer, an individual pending a background inquiry, provided, the licensee requests the inquiry within three business days of the conditional acceptance of the individual.

(4) Licensees shall, before employing directly or by contract, or accepting any person as a volunteer or student having direct contact with a vulnerable adult:

(a) Inform the prospective employee, contractor, volunteer, or student of the requirement for a background inquiry under RCW 43.43-830 through 43.43.842;

(b) Require a person to sign an acknowledgement statement that a background inquiry will be made;

(c) Verbally inform the person of the background inquiry results within seventy-two hours of receipt; and

(d) Offer to provide a copy of the background inquiry results to the prospective employee, contractor, volunteer, or student (within ten days of receipt).

(5) Licensees shall:

(a) Require all current employees, contractors, volunteers, and students engaged on or after July 22, 1989, to sign disclosure statements; and

(b) Ensure background inquiries are conducted on all individuals identified in (a) of this subsection having direct contact with vulnerable adults.

(6) The licensee shall establish and implement procedures ensuring:

(a) All disclosure statements and background inquiry responses are maintained in a confidential and secure manner;

(b) Disclosure statements and background inquiry responses are used for employment purposes only;

(c) Disclosure statements and background inquiry responses are not disclosed to any person except:

(i) The person about whom the licensee made the disclosure or background inquiry;

(ii) Authorized state and federal employees; and

(iii) The Washington state patrol auditor; and

(d) A record of findings are retained during and at least two years following termination of employment.

(7) The department shall:

(a) Conduct background inquiries specified under RCW 43.43.830 on all licensees or license applicants who can financially exploit or have direct contact with vulnerable adults;

(b) Notify the licensee or license applicant of the results of the background inquiry;

(c) Review records required under this section;

(d) Investigate allegations of noncompliance with RCW 43.43.830 through 43.43.842, when necessary, in consultation with law enforcement personnel; and

(e) Use information collected under this section solely for the purpose of determining eligibility for licensure or relicensure as required under RCW 43.43.842.

(8) The department may require that licensees complete additional disclosure statements or background inquiries for employees, contractors, volunteers, or students, if the department has reason to believe that offenses specified under RCW 43.43.830 have occurred since completion of the original disclosure statement or background inquiry.

### WSR 92-15-086

#### EMERGENCY RULES

#### DEPARTMENT OF FISHERIES

[Order 92-46—Filed July 16, 1992, 3:46 p.m., effective July 17, 1992, 12:01 a.m.]

Date of Adoption: July 14, 1992.

Citation of Existing Rules Affected by this Order:  
Repealing WAC 220-56-19000U.

Statutory Authority for Adoption: RCW 75.08.080.

Pursuant to RCW 34.05.350 the agency for good cause finds that immediate adoption, amendment, or repeal of a rule is necessary for the preservation of the public health, safety, or general welfare, and that observing the time requirements of notice and opportunity to comment upon adoption of a permanent rule would be contrary to the public interest.

Reasons for this Finding: A reduced bag limit in listed areas is needed to protect Hood Canal, Stillaguamish and Skagit River natural spawning coho. This is part of a coordinated management plan affecting all Washington fisheries that impact these stocks. This plan has been recommended by the Pacific Fisheries Management Council.

Effective Date of Rule: July 17, 1992, 12:01 a.m.

July 14, 1992

Judith Merchant

Deputy

for Robert Turner

Director

### NEW SECTION

**WAC 220-56-19000W SALTWATER SEASONS AND BAG LIMITS.** *Notwithstanding the provisions of WAC 220-57-190, effective 12:01 a.m. July 17, 1992 until further notice it is unlawful to take, fish for or possess more than:*

(1) *Two salmon per day in Catch Record Card Areas 5 and 6, except only one coho salmon in the daily bag limit.*

(2) *Two salmon per day in Catch Record Card Areas 7, 8-1, 8-2, 9 and 12.*

(3) *Minimum size 22 inches for chinook salmon and no minimum size for other salmon.*

**Reviser's note:** The typographical error in the above section occurred in the copy filed by the agency and appears in the Register pursuant to the requirements of RCW 34.08.040.

### REPEALER

*The following section of the Washington Administrative Code is repealed:*

**WAC 220-56-19000U SALTWATER SEASONS AND BAG LIMITS. (92-39)**

**WSR 92-15-087**

**PERMANENT RULES**

**DEPARTMENT OF LICENSING**

[Filed July 17, 1992, 9:03 a.m.]

Date of Adoption: July 17, 1992.

Purpose: To implement salon/shop, booth renter, mobile operator, and personal service operator section of the law; and minor miscellaneous changes.

Citation of Existing Rules Affected by this Order:  
Amending WAC 308-20-210.

Statutory Authority for Adoption: Chapter 18.16 RCW.

Pursuant to notice filed as WSR 92-10-079 on May 6, 1992.

Effective Date of Rule: Thirty-one days after filing.  
 July 17, 1992  
 Marsha Tadano Long  
 Assistant Director

**NEW SECTION**

WAC 308-20-001 AUTHORITY AND PURPOSE. These rules are adopted under the authority of RCW 18.16.030(2) and 34.05.220.

**NEW SECTION**

WAC 308-20-005 APPLICABLE STATUTES. The regulations in this chapter shall be considered a supplement to and not a replacement of chapter 18.16 RCW.

**NEW SECTION**

WAC 308-20-045 PERFORMANCE EXAMINATION. Each school will design and administer a practical performance and general knowledge examination that will evaluate and demonstrate each student's physical application of the basic technical skills in the course of which they are enrolled. Each school will submit a sample outline of their practical examination for inclusion in the school file.

**AMENDATORY SECTION** (Amending WSR 92-04-006, filed 1/23/92, effective 2/23/92)

WAC 308-20-210 COSMETOLOGY, BARBER, MANICURIST, ESTHETICIAN, SALON/SHOP, BOOTH RENTER, MOBILE OPERATOR AND PERSONAL SERVICE OPERATOR FEES. The following fees shall be charged by the professional licensing division of the department of licensing:

Title of Fee	Fee
<b>Cosmetologist:</b>	
Examination application	\$ 25.00
Examination retake	25.00
Renewal per year	20.00
Late renewal penalty	20.00
Duplicate license	15.00
Certification	25.00
Out-of-state application	25.00
<b>Instructor:</b>	
Examination application	30.00
Examination retake	30.00
Renewal per year	20.00
Late renewal penalty	20.00
Duplicate license	15.00
Certification	25.00
Out-of-state application	30.00
<b>Manicurist:</b>	
Examination application	25.00
Examination retake	25.00
Renewal per year	20.00
Late renewal penalty	20.00

Title of Fee	Fee
Duplicate license	15.00
Certification	25.00
Out-of-state application	25.00
<b>Esthetician:</b>	
Examination application	25.00
Examination retake	25.00
Renewal per year	20.00
Late renewal penalty	20.00
Duplicate license	15.00
Certification	25.00
Out-of-state application	25.00
<b>Barber:</b>	
Examination application	25.00
Examination retake	25.00
Renewal per year	20.00
Late renewal penalty	20.00
Duplicate license	15.00
Certification	25.00
Out-of-state application	25.00
<b>School:</b>	
License application	175.00
Renewal per year	175.00
Late renewal penalty	175.00
Duplicate license	15.00
Curriculum review	15.00
<b>(Barber:</b>	
Examination application	25.00
Examination retake	25.00
Renewal per year	20.00
Late renewal penalty	20.00
Out-of-state application	25.00
Duplicate	15.00
Certification	25.00))
<b>Salon/shop:</b>	
Application	50.00
Renewal	50.00
Late renewal penalty	50.00
Duplicate license	15.00
<b>Booth renter:</b>	
Application	50.00
Renewal	50.00
Late renewal penalty	50.00
Duplicate license	15.00
<b>Mobile operator:</b>	
Application	50.00
Renewal	50.00
Late renewal penalty	50.00
Duplicate license	15.00
<b>Personal service operator:</b>	
Application	50.00
Renewal	50.00
Late renewal penalty	50.00
Duplicate license	15.00

NEW SECTION

**WAC 308-20-310 MINIMUM SANITATION, SAFETY AND HEALTH STANDARDS FOR ALL INDIVIDUAL LICENSEES.** Each licensed cosmetologist, barber, manicurist, and/or esthetician shall be responsible for ensuring that sanitation, safety and health measures are applied for the maximum protection of the clients and co-workers by adhering to the following minimum standards.

(1) Adequate supply of hot and cold running water shall be available for work and sanitary purposes.

(2) Clean towels, robes, or gowns shall be provided for each client and shall be laundered after every use. Laundered towels, robes, or gowns shall be stored in cabinets with tight fitting doors, which shall be kept closed to protect linens from dust and dirt.

(3) A clean towel, not used for any purpose since laundering, shall be placed on the headrest of facial chairs before any patron reclines in that chair. A clean towel will be placed between the head and shampoo bowl when a patron is reclined in the chair for shampooing/rinsing. A paper strip or clean towel shall be placed completely around the neck of each customer before any apron or hair cloth or any other protective device is fastened around the neck.

(4) Shampoo bowls shall be cleaned with soap or other detergent and water after each shampoo.

(5) All implements shall be disinfected after each use. Once disinfected they shall be stored in clean sealed containers or under ultraviolet light to maintain dry air sanitation. Used implements shall be stored in a covered and marked container in an area separate from the disinfected implements. Hair must be removed before disinfecting.

(6) Work stands shall be kept free of hair, dust, and dirt and in a clean sanitary condition.

(7) All trays, floors, walls, chairs, headrests, tools, and other implements must have a cleanable surface and shall be free from dust, dirt, and other foreign materials.

(8) Each licensee will thoroughly cleanse his or her hands with soap and water immediately before and after serving each patron.

(9) No work shall be performed by or on any individual having a visible disease or parasites unless the patron shall produce a certificate from a licensed practicing physician stating that the patron is free from infectious, contagious, or communicable disease.

(10) Individual amounts of lotion must be poured into a clean container and applied with individual pieces of clean gauze or cotton. Creams and other semi-solid substances must be removed from the container with a spatula. All containers must be covered when not in use and maintained in a clean dust-free manner.

(11) All reusable articles that come in direct contact with a client's skin shall be cleaned and disinfected after each use. Items such as cotton pads or strips, eye shields, or neck strips that cannot be effectively laundered shall be disposed of in a waste receptacle immediately after use.

(12) Waste receptacles shall be located at each work station. The receptacle shall be emptied, cleaned, and disinfected daily.

(13) All hair clipping will be swept after each client.

NEW SECTION

**WAC 308-20-500 DEFINITIONS.** "Clean" means neat and tidy, made free from dirt, contamination, or other impurities by washing, sweeping, clearing away, or any other appropriate method.

"Department" means the department of licensing.

"Director" means the director of the department of licensing.

"Disinfect" means to cleanse of all harmful bacteria.

"Disinfectant" means a chemical agent which inhibits, neutralizes, or destroys all bacteria. It must be a germicide, fungicide, and virucide to comply with the disinfecting requirements of this chapter.

"Fire retardant container" means an air tight container made of metal or other approved material recognized by a national testing laboratory.

"Location license" means the license required to operate a cosmetology, barbering, esthetics, or manicuring business in a salon/shop, a rented booth, a mobile unit, or any other place selected by the client solely for the convenience of the client.

"Mobile unit" means the fully contained motorized structure in which a mobile operator or operators practice cosmetology, barbering, esthetics, or manicuring.

"Sterilization" means to make free of microbes or other contamination by use of live steam, dry heat or chemical compounds.

NEW SECTION

**WAC 308-20-510 MINIMUM OPERATOR LICENSING STANDARDS.** No person shall practice cosmetology, barbering, esthetics, or manicuring unless the person has qualified for and passed the approved state examination and has in their possession the appropriate Washington state operator license.

NEW SECTION

**WAC 308-20-520 MINIMUM SALON/SHOP LICENSING STANDARDS.** No person shall operate a cosmetology, barbering, esthetics, or manicuring salon/shop, booth rental, mobile unit, or personal services operator business in this state unless the business has qualified for and has in their possession a location license issued by the department of licensing, professional licensing, cosmetology section. If the ownership of the business changes, a new complete application must be submitted for approval and license issuance. Licenses are not transferable.

(1) A salon/shop shall not allow an operator to practice in leased space unless the operator possesses both a valid operator and booth renter license for that specific location.

(2) A business that has one or more branch locations shall obtain a separate salon/shop license for each location.

(3) A salon/shop establishment that does not meet the requirements of this chapter shall not offer or sublet booth rentals.

(4) A licensed operator who provides cosmetology, barbering, esthetics, or manicuring services to place bound clients in the client's home or in a long or short term health care facility is not required to obtain a location license.

(5) A long or short term health care facility that establishes a salon/shop and operates it on a for profit basis for clients other than place bound clients shall obtain a location license.

#### NEW SECTION

**WAC 308-20-530 MINIMUM LICENSING REQUIREMENTS.** To qualify for licensure the following minimum requirements must be met.

- (1) Maintain a separate outside entrance.
- (2) Salon/shops shall be directly supervised by cosmetologists or individuals licensed in the services offered. Any change in direct supervision of a licensed salon/shop must be submitted to the department of licensing, cosmetology unit within five days of the change.
- (3) A booth renter, mobile operator, personal service operator are considered individual business licenses and the individual is considered the direct supervisor.
- (4) No rooms used for residential purposes may be used as part of a salon/shop except for toilet facilities.
- (5) Salon/shops and mobile operators shall provide proof of public liability insurance in the amount of not less than one hundred thousand dollars.
- (6) Booth renters shall provide proof of public liability insurance in the amount of not less than one hundred thousand dollars. This insurance must be in addition to the salon/shop insurance and specifically name the booth renter.
- (7) Personal service operators shall provide proof of public liability insurance in the amount of not less than one hundred thousand dollars. This insurance must provide coverage in any and all locations in which services may be performed.
- (8) Each cosmetology, barbering, esthetics, or manicuring business shall obtain the necessary federal, state, and local business licenses, registrations, and permits before operating a business in this state.

#### NEW SECTION

**WAC 308-20-540 APPLICATION PROCESS.** Any person wishing to operate a cosmetology, barbering, esthetics, or manicuring business shall:

- (1) Obtain the application packet approved by the department;
- (2) Complete the application form and attachments in every respect including any actions directed by the application instructions;
- (3) Return the completed form, attachments, and the stated licensing fee to the department for approval and granting of the license.

#### NEW SECTION

**WAC 308-20-545 LICENSE ISSUANCE.** (1) Initial salon/shop licenses will be issued to expire September 1. The license must be renewed by September 1 of each year to avoid a penalty fee.

(2) Initial booth renters, mobile operators, personal service operators licenses will be issued to expire on the applicants next birth date. The licenses must be renewed each year on or before the birth date to avoid a penalty fee.

#### NEW SECTION

**WAC 308-20-550 POSTING OF REQUIRED LICENSES, REGISTRATIONS, PERMITS, AND NOTICE TO CONSUMERS.** (1) Licenses and the consumer notice required by chapter 18.16 RCW, shall be posted in direct public view in each salon/shop, rental booth and mobile unit. Personal service operators shall display their licenses and consumer notice in direct view of their client.

(2) Original operator licenses with an attached current photograph shall be posted in clear view of clients in the operator's booth or work station. The residence address of the operator, if shown on the license, may be blocked from public view.

(3) A pocket identification card may not be used in lieu of an original license.

(4) No license which has expired or become invalid for any reason shall be displayed by any operator or business in connection with the practice of cosmetology, barbering, esthetics, or manicuring. Any license so displayed shall be surrendered to a department representative upon its request.

(5) Licenses issued by another state, territory, or foreign country shall not be displayed in any salon/shop.

(6) A receipt, issued by the department of licensing, showing the application for a duplicate license may be used if the original has been lost, stolen, or otherwise destroyed until the duplicate license is received.

#### NEW SECTION

**WAC 308-20-560 BOOTH RENTER, MOBILE OPERATOR, AND PERSONAL SERVICES OPERATOR LOCATION LICENSE RENEWAL PROCESS.** Each booth renter, mobile operator, and personal services operator license shall be renewed on a yearly basis to conform to the date of birth of the owner of the business. The renewal request shall be accompanied by:

- (1) The license renewal fee required under the provisions of WAC 320-20-210.
- (2) Confirmation, from the insurance company, of continued coverage of public liability insurance for the requested license renewal period.
- (3) A statement noting any changes to the information contained in the original application form and attachments.
- (4) Licenses must be renewed on or before the expiration date. Failure to renew the license by the expiration date shall result in a penalty fee.

(5) Failure to receive a notice of license renewal from the department shall not constitute cause for failure to renew.

#### NEW SECTION

**WAC 308-20-570 SALON/SHOP LICENSE RENEWAL PROCESS.** Each salon/shop license shall be renewed on a yearly basis prior to the first day of September of each year. The renewal request shall be accompanied by:

(1) The license renewal fee required under the provisions of WAC 320-20-210.

(2) Confirmation, from the insurance company, of continued coverage of public liability insurance for the requested license renewal period.

(3) A statement noting any changes to the information contained in the original application form and attachments.

(4) Licenses must be renewed on or before the expiration date. Failure to renew the license by the expiration date shall result in a penalty fee.

(5) Failure to receive a notice of license renewal from the department shall not constitute cause for failure to renew.

#### NEW SECTION

**WAC 308-20-590 MINIMUM BUSINESS LOCATION SANITATION, SAFETY, AND HEALTH STANDARDS.** Each cosmetology, barbering, esthetics, or manicuring business shall be responsible for ensuring that sanitation, safety, and health measures are applied for the maximum protection of the clients and employees by adhering to the following standards.

(1) An adequate supply of hot and cold running water shall be available for work and sanitary purposes. Businesses shall also supply drinking facilities for clients and employees acceptable to state and local health departments.

(2) Clean towels, robes, or gowns shall be provided for each client and shall be laundered after every use. Laundered towels, robes, or gowns shall be stored in cabinets with tight fitting doors, which shall be kept closed to protect linens from dust and dirt.

(3) Clients shall be protected from direct contact with capes, shampoo bowls, etc., by the use of clean towels and/or protective neck strips.

(4) All reusable articles that come in direct contact with a client's skin shall be cleaned and disinfected after each contact. Items such as cotton pads or strips, eye shields, or neck strips that cannot be effectively laundered shall be disposed of in a waste receptacle immediately after use.

(5) Soiled linens shall be kept in ventilated closed containers. Towels, robes, and gowns shall not be washed or dried on the premises except in suitable automatic washers and dryers that provide appropriate disinfecting of linens.

(6) All chemicals shall be labeled and shall be stored in compliance with state and local laws and manufacturer's instructions to ensure maximum identification and protection against fires, fumes, contamination, or

corrosion of containers. Stored chemicals should be inspected regularly and corroded containers must be discarded immediately.

(7) A separate area with an adequate supply of hot and cold running water shall be designated as a dispensary for the dispensing of supplies, the cleaning of tools, equipment, and other materials, and the flushing of skin in the event of spilled chemicals.

(8) Hazardous chemicals and flammable liquid signs shall be posted in the dispensary, storage room, and any other location these materials may be located.

(9) Fire extinguishers shall be readily accessible to the dispensary, storage room, and other locations where flammable liquids may be kept. Fire extinguishers shall be inspected at least once a year or more often as required by the local fire department or the manufacturer.

(10) Fresh, clean, wet disinfectant solution shall be kept in a covered container for the disinfecting of combs, brushes, and other tools or implements. Package directions shall be followed for solution strength. Disinfecting solutions shall be changed whenever necessary as determined by manufacturing direction or visible contamination.

(11) Shampoo bowls and drains shall be kept clean, disinfected, and free running.

(12) No services shall be provided if the operator or client has contracted any communicable disease.

(13) Waste disposal containers shall be emptied, cleaned, and disinfected daily.

(14) All trays, floors, walls, chairs, headrests, tools, and other implements must have a cleanable surface and shall be free from dust, dirt, and other foreign materials.

(15) All implements shall be disinfected after each use. Once disinfected they shall be stored in clean sealed containers or under ultraviolet light to maintain dry air sanitation. Used implements shall be stored in a covered and marked container in an area separate from the disinfected implements.

(16) Adequate toilet facilities shall be provided for the use of clients and employees. All toilet facilities shall be kept clean, sanitary, and in proper condition at all times. The toilet shall contain a hand washing sink, and an adequate supply of toilet paper and hand washing and drying supplies. The use of community towels or multiple use bar soap is prohibited.

Toilet facilities shall be located within the business premises, or in an area that is reasonably accessible if the business is located in a multiple business building or a residence.

(17) Operators shall thoroughly wash their hands with soap and water after each toilet use and before providing any service to clients.

(18) Operators shall wear fresh, clean, fluid proof protective gloves while performing any client or practice related activity if any bodily discharge is present or if any discharge is likely to occur because of services being performed.

(19) The salon/shop shall be designed and equipped with client and employee health and safety in mind.

(a) Ventilation shall be designed to provide free flow of air to each room in proportion to the size, use, and capacity of the room, to prevent the buildup of emissions

and particulates, to keep odors and diffusions from chemicals and solutions at a safe level and to provide sufficient air circulation and oxygen. Ventilation may be by natural or mechanical means.

(b) Electrical wiring, cords, appliances, and equipment shall be installed and maintained at all times in such condition as to pass inspection by the local fire district. Electrical plug-ins and equipment shall not display any frays and must be properly repaired to prevent shock.

(c) Floors, walls, and fixtures and equipment should be clean, in good repair, and regularly maintained.

Exception: Personal services operators are exempt from the minimum standards concerning facilities requirements but shall comply with all other minimum standards such as washing, cleaning, disinfecting, and disposal. Booth renters shall not rent from a salon shop that is not in compliance with facilities requirements.

#### NEW SECTION

**WAC 308-20-600. DISINFECTING AND STERILIZING OF TOOLS AND OTHER IMPLEMENTS.** Adequate chemical disinfecting agents or sterilization equipment shall be available for use as needed at all times when the business is open to clients or operators.

(1) When sterilization equipment is used it shall be checked annually to assure that it is reaching the temperature required by the manufacturer's instructions.

(2) When commercially manufactured disinfectant solution is used it shall be mixed and used according to the manufacturer's instructions.

(3) When used according to the manufacturer's instructions the following methods may be used to disinfect and sterilize tools and equipment.

(a) Immersion of the object in the disinfectant solution.

(b) Dry heat or autoclave sterilizer registered with the Federal Food and Drug Administration.

(4) All items which cannot be sterilized or disinfected and shall be discarded after each use.

#### NEW SECTION

**WAC 308-20-610. CHEMICAL USE AND STORAGE.** (1) When administering services to a client that involve the use of chemicals or chemical compounds, all practitioners shall follow safety procedures which prevent injury to the client's person or clothing.

(2) Any shop owner or practitioner using chemicals or chemical compounds in providing services to clients shall store the chemicals so as to prevent fire, explosion, or bodily harm.

(a) Flammable chemicals shall be stored away from potential sources of ignition.

(b) Chemicals which could interact in a hazardous manner such as oxidizers, catalysts, and solvents, shall be segregated in storage.

(c) All chemicals shall be stored in accordance with the manufacturer's directions.

#### NEW SECTION

**WAC 308-20-630. WORKER RIGHT TO KNOW.** Each owner or manager responsible for the operation of a cosmetology, barbering, esthetics, or manicuring business shall obtain information regarding the chemical hazard communication guidelines for Washington employers and establish the program required by the Worker and Community Right to Know Act administered by the industrial safety and health division of the department of labor and industries.

#### NEW SECTION

**WAC 308-20-640. EDUCATIONAL, MEDICAL, FIRST AID, AND ACCIDENT PREVENTION PROGRAMS.** Each owner or manager responsible for the operation of a cosmetology, barbering, esthetics, or manicuring business shall obtain information and establish first aid and accident prevention policies and procedures to promote the safety and health of clients and operators as required by the department of labor and industries.

#### NEW SECTION

**WAC 308-20-670. PETS ON THE PREMISES.** Pets or other animals shall not be allowed on the premises of any business at any time, except for trained aid animals for sightless, hearing impaired, or otherwise differently abled persons.

#### NEW SECTION

**WAC 308-20-680. COMPLIANCE WITH STATE, FEDERAL, AND LOCAL BUILDING CODES.** All cosmetology, barbering, esthetics, and manicuring business owners and managers shall ensure that each business location, whether stationary or mobile, is in compliance with the following federal and state building codes adopted by the state building code council, department of community development, and the state building code statutes adopted by the legislature and the county and city building codes adopted by the county or city in which the business premises is located.

#### NEW SECTION

**WAC 308-20-690. INSPECTION OF PREMISES.** Every owner, supervisor, manager, and/or operator of any cosmetology, barbering, esthetics, or manicuring business shall allow a department representative to inspect the business during business hours and shall provide any documents or statements requested. Failure to cooperate with a department representative may result in disciplinary action as stated in RCW 18.16.210.

#### NEW SECTION

**WAC 308-20-700. PENALTY FOR FAILURE TO OBTAIN OPERATOR OR LOCATION LICENSES OR COMPLY WITH STATUTES OF REGULATORY AUTHORITIES.** (1) Any person or business who fails to obtain the required operator or location licenses before engaging in the commercial practice or operation of a cosmetology, barbering, esthetics,

or manicuring business is subject to the imposition of a fine of one thousand dollars.

(2) Any applicant or licensee who fails to comply with the provisions of this chapter and chapter 18.16 RCW or other federal state and local statutes, regulations, and ordinances as these requirements apply to cosmetology, barbering, esthetics, or manicuring practices, schools or businesses shall be subject to the penalties imposed by the director under the provisions of RCW 18.16.210.

**WSR 92-15-088**  
**ATTORNEY GENERAL OPINION**  
**Cite as: AGO 1992 No. 14**  
 [July 15, 1992]

**TAXATION—PROPERTY—COUNTIES—BOARD OF EQUALIZATION—AUTHORITY OF COUNTY BOARD OF EQUALIZATION TO EQUALIZE THE ASSESSMENT OF PROPERTY**

1. RCW 84.48.010 authorizes the county board of equalization to equalize the assessment of the property in the county. The board has the authority to equalize property on the assessment role on its own motion, even if the property has not been revalued in the current year.
2. If the board of equalization equalizes the value of property on the assessment role, that was not revalued during the current year, the board must measure the value of that property against the fair market value in the assessor's revaluation year in which the property was valued.

Requested by:

Honorable Michael J. Sullivan  
 Pacific County Prosecuting Attorney  
 Post Office Box 45  
 South Bend, Washington 98586

**WSR 92-15-089**  
**NOTICE OF PUBLIC MEETINGS**  
**UNIVERSITY OF WASHINGTON**  
 [Memorandum—July 14, 1992]

Following is a revised meeting schedule for regular meetings to be held by the University of Washington's Faculty Senate Committee:

**Senate Committee**

Meeting Dates	Location	Time
Oct. 22	301 Gowen	2:30 p.m.
Dec. 3		

**Executive Committee**

Meeting Dates	Location	Time
Oct. 5	TBA	2:30 p.m.
Nov. 9		

**WSR 92-15-090**  
**NOTICE OF PUBLIC MEETINGS**  
**UNIVERSITY OF WASHINGTON**  
 [Memorandum—July 14, 1992]

Following is a revised meeting schedule for regular meetings to be held by the University of Washington's Department of Comparative Religion:

**Faculty Meeting**

Meeting Dates	Location	Time
Oct. 2	Thomson 317	12:30
Nov. 6	Thomson 317	12:30
Dec. 4	Thomson 317	12:30

**WSR 92-15-091**  
**NOTICE OF PUBLIC MEETINGS**  
**UNIVERSITY OF WASHINGTON**  
 [Memorandum—July 15, 1992]

Following is a revised meeting schedule for regular meetings to be held by the University of Washington's Graduate School of Library and Information Sciences:

**Faculty Meetings**

Meeting Dates	Location	Time
September 18, 1992	Suzzallo 127	9:00 a.m.
October 13, 1992	Suzzallo 127	2:30
October 27, 1992	Suzzallo 127	2:30
November 10, 1992	Suzzallo 127	2:30
November 24, 1992	Suzzallo 127	2:30
December 8, 1992	Suzzallo 127	2:30

**WSR 92-15-092**  
**NOTICE OF PUBLIC MEETINGS**  
**HUMAN RIGHTS COMMISSION**  
 [Memorandum—July 16, 1992]

The Washington State Human Rights Commission will hold its August regular commission meeting by telephone conference call on August 20, 1992, beginning at 10:00 a.m. The telephone conference call will originate at the office of the Washington State Human Rights Commission, 711 South Capitol Way, Suite 402, Olympia, (206) 753-4876 and is being held to close cases and to conduct a brief business meeting to discuss budget and legal matters. An executive session will be convened if necessary.

**WSR 92-15-093**  
**PROPOSED RULES**  
**SUPERINTENDENT OF PUBLIC INSTRUCTION**  
 [Filed July 17, 1992, 3:38 p.m.]

Original Notice.  
 Title of Rule: WAC 392-122-320 through 392-122-322, traffic safety education allocations.

Purpose: To define procedures for allocating state traffic safety education moneys for the 1992-93 school year and thereafter.

Statutory Authority for Adoption: RCW 28A.220.030.

Statute Being Implemented: RCW 28A.220.040 and section 509, chapter 232, Laws of 1992.

Summary: Beginning in the 1992-93 school year, state allocations are restored for all traffic safety education students. Additional state allocations for low-income traffic safety education students are continued.

Reasons Supporting Proposal: Changes are required by 1992 amendments to the 1991-93 Operating Appropriations Act.

Name of Agency Personnel Responsible for Drafting: Richard Wilson, Superintendent of Public Instruction, Olympia, 753-2298; Implementation: Thomas Case, Superintendent of Public Instruction, Olympia, 753-6708; and Enforcement: David Moberly, Superintendent of Public Instruction, Olympia, 753-6742.

Name of Proponent: Superintendent of Public Instruction, governmental.

Rule is not necessitated by federal law, federal or state court decision.

Explanation of Rule, its Purpose, and Anticipated Effects: See Purpose and Summary above.

Proposal Changes the Following Existing Rules: See Summary above.

No small business economic impact statement is required for this proposal by chapter 19.85 RCW.

Hearing Location: Superintendent of Public Instruction, Old Capitol Building, Wanamaker Conference Room, 2nd Floor, Olympia, Washington 98504-7200, on August 28, 1992, at 9:00 a.m.

Submit Written Comments to: Richard M. Wilson, P.O. Box 47200, Olympia, WA 98504-7200, by August 25, 1992.

Date of Intended Adoption: September 4, 1992.

July 17, 1992  
Judith A. Billings  
Superintendent of  
Public Instruction

AMENDATORY SECTION (Amending Order 92-04, filed 1/22/92, effective 2/22/92)

WAC 392-122-320 TRAFFIC SAFETY EDUCATION—APPORTIONMENT OF STATE MONEYS. From moneys appropriated for traffic safety education, the superintendent of public instruction shall allocate moneys to each school district as follows:

(1) For the 1991-92 school year, the school district's allocation equals:

(a) The number of completing students as reported on Form F-196 for the 1989-90 school year; multiplied by

(b) The percentage of enrollment determined by the superintendent of public instruction to be eligible for free and reduced priced lunches for the 1990-91 school year; and further multiplied by

(c) The state-wide uniform rate determined by dividing the available appropriation for the 1991-92 school year by the estimated state-wide number of low-income traffic safety education completers.

(2) Payments for the 1991-92 school year shall be at the rate of ten percent a month for the months of September through June.

(3) Moneys for the 1991-92 school year recovered pursuant to WAC 392-122-322 ~~((shall))~~ may be reallocated proportionately

among school districts which report 1991-92 low-income tuition assistance in excess of the allocation provided pursuant to subsection (1) of this section.

(4) For the 1992-93 school year and thereafter, the school district's allocation equals the sum of the following amounts:

(a) The number of completing low-income students reported by the school district pursuant to WAC 392-122-321 times the state-wide uniform rate determined by dividing the available appropriation for low-income tuition assistance by total completing low-income students reported by all school districts; and

(b) The total number of completing students reported by the school district pursuant to WAC 392-122-321 times the state-wide uniform rate determined by dividing the available appropriation (excluding low-income tuition assistance moneys) by total completing students reported by all school districts.

(5) For the 1992-93 school year and thereafter the superintendent of public instruction shall make payments in the same manner as provided in WAC 392-121-400.

AMENDATORY SECTION (Amending Order 92-04, filed 1/22/92, effective 2/22/92)

WAC 392-122-321 TRAFFIC SAFETY EDUCATION—SCHOOL DISTRICT REPORTING. Each school district receiving state traffic safety education moneys for a school year shall report to the superintendent of public instruction as follows:

(1) By November 1 of the following school year, the school district shall report the following information for the school year of the allocation:

~~((+))~~ (a) The total number of traffic safety education completing students;

~~((+))~~ (b) The total number of low-income traffic safety education completing students;

~~((+))~~ (c) The amount of the traffic safety education allocation used for providing low-income tuition assistance;

~~((+))~~ (d) The criteria used for providing low-income assistance;

~~((+))~~ (e) The fee paid by low-income completing students; and

~~((+))~~ (f) The fee paid by completing students who are not low-income.

(2) At any time prior to November 1, 1993, any school district using 1992-93 traffic safety education moneys provided pursuant to this chapter to reimburse students for traffic safety education fees paid during the 1991-92 school year, may report the amount of such reimbursements to the superintendent of public instruction. Such report shall be in writing and shall be signed by the school district superintendent or the superintendent's designee.

AMENDATORY SECTION (Amending Order 92-04, filed 1/22/92, effective 2/22/92)

WAC 392-122-322 TRAFFIC SAFETY EDUCATION—RECOVERY OF MONEYS. The superintendent of public instruction shall recover traffic safety education allocations as follows:

(1) After November 1 of the following school year, the superintendent of public instruction shall compare each school district's state traffic safety education allocation for low-income tuition assistance for the school year and the amount ~~((the school district used to provide))~~ of low-income tuition assistance for traffic safety education provided by the school district for the school year as reported pursuant to WAC 392-122-321 (1)(c). Any part of the allocation not used to provide low-income tuition assistance shall be recovered.

(2) Moneys may be recovered pursuant to chapter 392-117 WAC, WAC 392-122-900, or ~~((WAC))~~ 392-122-910.

(3) In determining recoveries of traffic safety education allocations other than those provided for low-income tuition assistance the superintendent of public instruction shall compare such allocations to the school district's total traffic safety education expenditures for the school year as reported on Report F-196, Part III. For the purpose of determining recoveries for the 1992-93 school year, any reimbursement reported by a school district pursuant to WAC 392-122-321(2) shall be added to the district's 1992-93 traffic safety education expenditures.



**WSR 92-15-094**  
**PROPOSED RULES**  
**SUPERINTENDENT OF**  
**PUBLIC INSTRUCTION**  
 [Filed July 17, 1992, 3:40 p.m.]

**Original Notice.**

**Title of Rule:** WAC 392-122-255 and 392-122-900, state funding for institutional education programs.

**Purpose:** To revise the method of allocating state moneys for indirect costs of institutional education programs.

**Statutory Authority for Adoption:** RCW 28A.150.290.

**Statute Being Implemented:** Chapter 28A.190 RCW and section 513, chapter 232, Laws of 1992.

**Summary:** For the 1992-93 school year and thereafter, state allocations for indirect costs of institutional education programs shall be based on the indirect cost rate assumed in the state Operating Appropriations Act.

**Name of Agency Personnel Responsible for Drafting:** Richard Wilson, Superintendent of Public Instruction, Olympia, 753-2298; **Implementation:** Thomas Case, Superintendent of Public Instruction, Olympia, 753-6708; and **Enforcement:** David Moberly, Superintendent of Public Instruction, Olympia, 753-6742.

**Name of Proponent:** Superintendent of Public Instruction, governmental.

Rule is not necessitated by federal law, federal or state court decision.

**Explanation of Rule, its Purpose, and Anticipated Effects:** See Summary above.

**Proposal Changes the Following Existing Rules:** See Summary above.

No small business economic impact statement is required for this proposal by chapter 19.85 RCW.

**Hearing Location:** Superintendent of Public Instruction, Old Capitol Building, Wanamaker Conference Room, 2nd Floor, Olympia, Washington 98504-7200, on August 28, 1992, at 9:00 a.m.

**Submit Written Comments to:** Richard M. Wilson, P.O. Box 47200, Olympia, WA 98504-7200, by August 25, 1992.

**Date of Intended Adoption:** September 4, 1992.

July 17, 1992  
 Judith A. Billings  
 Superintendent of  
 Public Instruction

**AMENDATORY SECTION** (Amending Order 92-03, filed 1/10/92, effective 2/10/92)

WAC 392-122-255 STATE INSTITUTIONAL EDUCATION PROGRAM—INSTITUTIONAL PROGRAM INDIRECT COST. State institutional education program moneys for the purpose of recognition of institutional program indirect costs shall be allocated to school districts as follows:

(1) For the 1991-92 school year, the allocation shall be based on the school district's indirect cost percent for the institutional program from Report F-196 Part III and in accordance with the state Operating Appropriations Act.

(2) For the 1992-93 school year and thereafter, the allocation shall be based on the indirect cost rate assumed in the state Operating Appropriations Act.

**AMENDATORY SECTION** (Amending Order 85-16, filed 12/9/85)

WAC 392-122-900 GENERAL PROVISION—CARRYOVER PROHIBITION. Categorical apportionment moneys shall not be carried over by a school district from one school district fiscal year to another. ((Moneys distributed by the superintendent of public instruction for a categorical program which remain unspent during the applicable school district fiscal year in expenditure classifications deemed allowable by the superintendent of public instruction including indirect expenditures and abatements listed on Year-End Financial Statement F-196 Part III, shall:))

(1) The superintendent of public instruction shall recover categorical program allocations made pursuant to this chapter which are not expended by the school district during the school year for allowable program costs:

(a) Moneys recovered at the end of the school year beginning during the first year of each biennium (revert to the superintendent of public instruction) shall be available for reallocation (and (2)) by the superintendent of public instruction.

(b) Moneys recovered at the end of the school year beginning during the second year of each biennium shall revert to the state treasurer: PROVIDED, That if prior to recovery, insufficient moneys are available to fully fund those programs operating in the second year of the biennium, any moneys recovered shall first be allocated to fully fund these programs.

(2) Except as provided in subsection (3) of this section, the amount recovered pursuant to subsection (1) of this section shall be determined as follows:

(a) Determine the state allocation for the categorical program;  
 (b) Determine the district's expenditures for the program including indirect expenditures and abatements deemed allowable by the superintendent of public instruction as reported on Year-End Financial Statement F-196, Part III or such other document filed by the district pursuant to instructions provided by the superintendent of public instruction;

(c) If the amount of (a) of this subsection exceeds the amount of (b) of this subsection, the difference shall be recovered.

(3) The amount recovered pursuant to subsection (1) of this section for the institutional education program for the 1992-93 school year and thereafter shall be determined as follows:

(a) Determine the state allocation for the institutional education program excluding any amount provided for indirect costs;

(b) Determine the district's direct expenditures for the institutional education program as reported on Year-End Financial Statement F-196 or such other document filed by the district pursuant to instructions provided by the superintendent of public instruction;

(c) If the amount of (a) of this subsection exceeds the amount of (b) of this subsection, the difference shall be recovered.

**WSR 92-15-095**  
**WITHDRAWAL OF PROPOSED RULES**  
**DEPARTMENT OF FISHERIES**  
 [Filed July 17, 1992, 4:15 p.m.]

The Washington State Department of Fisheries withdraws proposed amendments to the hydraulics code filed as WSR 92-11-082.

Judith Merchant  
 Deputy  
 for Robert Turner  
 Acting Director

**WSR 92-15-096**  
**NOTICE OF PUBLIC MEETINGS**  
**WORKFORCE TRAINING AND**  
**EDUCATION COORDINATING BOARD**  
 [Memorandum—July 17, 1992]

The Washington State Workforce Training and Education Coordinating Board (WTECB) will hold a board meeting on Monday, July 27, 1992, beginning at 1:00 p.m., at Building 31, Conference Center, Clover Park Technical College, 4500 Steilacoom Boulevard S.W., Tacoma, WA.

**WSR 92-15-097**  
**PROPOSED RULES**  
**HORSE RACING COMMISSION**  
 [Filed July 20, 1992, 10:41 a.m.]

**Original Notice.**

**Title of Rule:** WAC 260-32-400 Powers and duties.

**Purpose:** The amendment will enable a jockey's agent to handle the business of three jockeys at a race meet rather than only two.

**Statutory Authority for Adoption:** RCW 67.16.040.

**Summary:** Would change the rule to allow jockey agents to handle the business of three jockeys rather than two journeyman jockeys.

**Name of Agency Personnel Responsible for Drafting, Implementation and Enforcement:** Will Bachofner, Olympia, Washington, 459-6462.

**Name of Proponent:** Washington Horse Racing Commission, governmental.

**Rule is not necessitated by federal law, federal or state court decision.**

**Explanation of Rule, its Purpose, and Anticipated Effects:** To amend the jockey agent rule to allow a jockey agent to represent on behalf of a jockey, to ride certain horses in a race. Changing the existing rule of allowing only two journeymen jockeys.

**Proposal Changes the Following Existing Rules:** Amends the existing rule to allow a jockey agent to represent three jockeys rather than two journeymen jockeys.

**No small business economic impact statement is required for this proposal by chapter 19.85 RCW.**

**The enactment above is not anticipated to affect more than 20 percent of all industries nor more than 10 percent of any one industry as defined by section 2(3), chapter by laws of 1982. Therefore, a small business economic statement has not been prepared.**

**Hearing Location:** SeaTac Red Lion Inn, 18740 Pacific Highway South, Seattle, WA 98188, on September 8, 1992, at 1:00 p.m.

**Submit Written Comments to:** Will Bachofner, Executive Secretary, Washington Horse Racing Commission, 3700 Martin Way, Suite 101, Olympia, WA 98506, by September 7, 1992.

**Date of Intended Adoption:** September 8, 1992.

July 20, 1992  
 Will Bachofner  
 Executive Secretary

**AMENDATORY SECTION** (Amending Order 79-03, § 260-32-400, filed 12/24/79; Rules of racing, § 174, filed 3/11/65; filed 4/21/61.)

**WAC 260-32-400 POWERS AND DUTIES.** Each jockey agent shall be licensed on a regular form provided by the commission. No jockey agent shall be the owner or trainer of any horse. A jockey agent may represent ~~two~~ three ~~journeymen jockeys~~ providing the conditions justify and upon approval of the stewards. No jockey agent shall make or assist in making any engagement for any rider other than those he is licensed to represent. Each jockey agent shall keep, on a form provided by the association, a record by races of all engagements made by him of the riders he is representing. This record must be kept up to date and held ready at all times for the inspection by the stewards. If any jockey agent gives up the making of engagements for any rider, he shall immediately notify the stewards, and he shall also turn over to the stewards a list of any unfilled engagements he may have made for that rider. A jockey agent may not drop a rider without notifying the board of stewards in writing. All rival claims for the services of a rider will be adjusted by the stewards.

**Reviser's note:** The typographical errors in the above section occurred in the copy filed by the agency and appear in the Register pursuant to the requirements of RCW 34.08.040.

**WSR 92-15-098**  
**PROPOSED RULES**  
**STATE BOARD OF EDUCATION**  
 [Filed July 20, 1992, 10:53 a.m.]

**Original Notice.**

**Title of Rule:** WAC 180-75-085 General requirements—Teachers, administrators, educational staff associates, 180-79-045 Certificates—Previous standards, 180-79-060 Levels of certificates, 180-79-065 Initial and continuing certificates—Applicable conditions, 180-79-115 Academic requirements for certification—Teachers, 180-79-117 Experience requirement for continuing certification—Teachers, 180-79-122 Experience requirement for initial endorsement—Principals, 180-79-123 Experience requirement for continuing certification—Administrators, and 180-79-127 Experience requirement for continuing certification—ESAs.

**Purpose:** To permanently adopt changes required to be consistent with statutory amendments enacted by the 1992 legislature (chapter 141, Laws of 1992). These changes were adopted previously on an emergency basis.

**Statutory Authority for Adoption:** RCW 28A.410.010.

**Statute Being Implemented:** SSB 5953 Part I.

**Summary:** The changes eliminate the master's degree requirement for the continuing teacher's certificate and amend other WACs associated with the elimination of the master's degree.

**Reasons Supporting Proposal:** These changes are necessary to be consistent with legislation.

**Name of Agency Personnel Responsible for Drafting:** Richard Wilson, Superintendent of Public Instruction, Old Capitol Building, Olympia, 753-2298; **Implementation:** Ted Andrews, Superintendent of Public Instruction, Old Capitol Building, Olympia, 753-3222; and **Enforcement:** John Brickell, Superintendent of Public Instruction, Old Capitol Building, Olympia, 753-3222.

**Name of Proponent:** State Board of Education, governmental.

Rule is not necessitated by federal law, federal or state court decision.

Explanation of Rule, its Purpose, and Anticipated Effects: See above.

Proposal Changes the Following Existing Rules: Eliminates master's degree requirement for the continuing teacher's certificate, consistent with the repeal of the legislation regarding the master's degree requirement. Also eliminates other references to the August 31, 1992, date that were dependent on the master's requirement.

No small business economic impact statement is required for this proposal by chapter 19.85 RCW.

Hearing Location: San Juan Island Room, Northwest Educational Service District 189, 205 Stewart Road, Mount Vernon, WA 98273-5462, on September 24, 1992, at 9:00 a.m.

Submit Written Comments to: Dr. Monica Schmidt, Executive Director, State Board of Education, P.O. Box 47206, Olympia, WA 98504-7206, by September 22, 1992.

Date of Intended Adoption: September 25, 1992.

July 20, 1992

Monica Schmidt  
Executive Director/Secretary

AMENDATORY SECTION (Amending WSR 92-04-044, filed 1/31/92, effective 3/2/92)

WAC 180-75-085 GENERAL REQUIREMENTS—TEACHERS, ADMINISTRATORS, EDUCATIONAL STAFF ASSOCIATES. The following requirements are to be met by candidates for certification as teachers, administrators, or educational staff associates:

(1) Age. No person who is less than eighteen years of age shall receive a certificate to serve in the public or nonpublic schools of Washington state.

(2) Character. Applicants for certificates in Washington state who are not holders of a valid Washington state teacher's, administrator's, educational staff associate's, or vocational certificate must give evidence of good moral character and personal fitness as specified in WAC 180-75-082 and must ~~((make arrangements with the Washington state patrol for a background check as required by RCW 28A.410.010; PROVIDED, That applicants for vocational teaching certificates who do not make such an arrangement with the state patrol shall have placed on such certificates by the superintendent of public instruction a provision which restricts the certificate holder to the teaching of vocational technical institute students who are sixteen years of age or older))~~ complete a record check through the Washington state patrol criminal identification system and through the Federal Bureau of Investigation at the applicant's expense as required by RCW 28A.410.010; such record check shall include a fingerprint check using a Washington state patrol approved fingerprint card; PROVIDED, That the superintendent of public instruction may waive the record check for an applicant who has had a record check within the two years prior to application.

(3) Academic. A candidate for certification shall have successfully completed a state approved college/university professional preparation program and hold appropriate degrees, licenses, and additional course work as prescribed in chapter 180-79 WAC or have qualified under WAC 180-79-245; PROVIDED, That this section shall not apply to vocational, limited, internship, or instructional specialists certificates.

AMENDATORY SECTION (Amending WSR 90-12-075, filed 6/1/90, effective 7/2/90)

WAC 180-79-045 CERTIFICATES—PREVIOUS STANDARDS. (1) Certificates issued under previous standards which were issued for a specific term shall continue to be effective for that term. All persons who hold any standard teacher, administrator, or specialized personnel certificate issued under previous standards of the state board of education shall be issued a continuing certificate at such time as it is necessary for them to reinstate a standard certificate or on application and payment of the fee as specified in WAC 180-75-065(1):

PROVIDED, That ~~((until August 31, 1992;))~~ all persons who hold any provisional or initial certificate granted under previous standards of the state board of education shall be authorized to meet requirements for standard or continuing certification as set forth in the relevant previous standards so long as the standard or continuing certificate is obtained within six calendar years of the date on which the first provisional or initial certificate was issued; and, if such requirements are met, shall be issued a continuing certificate subject to the conditions of this chapter: PROVIDED FURTHER, That all persons who hold other than provisional or standard teaching certificates issued under standards of the state board of education adopted prior to 1971 shall be issued continuing certificates if they have completed forty-five quarter hours (thirty semester hours) of preparation past the baccalaureate degree and three years of experience: PROVIDED FURTHER, That any person holding a provisional certificate as a school nurse under provisions of chapter 180-84 WAC shall be granted a continuing certificate: PROVIDED FURTHER, That any person who holds a provisional principal's or provisional superintendent's certificate under previous standards of the state board of education shall be issued upon application, including payment of applicable fees, continuing administrative certificates with endorsements for such respective roles and such certificates shall be subject to the continuing education requirements of chapter 180-85 WAC.

(2) Except as noted in subsection (1) of this section, certificates issued under previous standards which were issued for an indefinite period shall continue to be in effect.

AMENDATORY SECTION (Amending WSR 90-12-075, filed 6/1/90, effective 7/2/90)

WAC 180-79-060 LEVELS OF CERTIFICATES. Two levels of certification may be issued:

(1) Initial certificate. The initial teacher certificate is valid for ~~((two))~~ four years and the initial administrator and educational staff associate certificates are valid for seven years. Initial teacher certificates shall be subject to renewal pursuant to WAC 180-79-065. Initial administrator and educational staff associate certificates shall not be subject to renewal ~~((; PROVIDED, That initial teacher certificates issued or applied for, if the candidate is otherwise eligible, prior to August 31, 1992, shall be valid for four years))~~.

(2) Continuing certificate. The continuing certificate is valid on a continuing basis as specified in WAC 180-79-065(2).

AMENDATORY SECTION (Amending WSR 90-12-075, filed 6/1/90, effective 7/2/90)

WAC 180-79-065 INITIAL AND CONTINUING CERTIFICATES—APPLICABLE CONDITIONS. The following shall apply to initial and continuing certificates issued pursuant to this chapter:

(1) Initial certificate.

~~((a))~~ An ~~((initial teacher certificate issued prior to August 31, 1992, and an))~~ initial educational staff associate or administrator certificate issued prior to August 31, 1988, or an initial teacher certificate may be renewed for an additional three-year period on application and verification that the individual has completed all course work requirements for continuing certification or has completed at least fifteen quarter hours (ten semester hours) of course work since the certificate was issued or renewed.

~~((b))~~ An initial teacher certificate issued on or after August 31, 1992 may be renewed for a three-year period by the applicant providing proof that he or she is enrolled in an approved masters degree program. A second renewal for a two-year period shall be granted if the candidate provides the following information from the degree granting institution:

(i) That the candidate has made substantial—i.e., fifty percent or more—progress toward the completion of an approved masters degree;

(ii) That the candidate has made satisfactory progress in the approved masters degree program;

(iii) That the candidate has made satisfactory arrangements to complete the approved masters degree program during the two-year extension period.)

(2) Continuing certificate.

(a) The continuing certificates of holders who were eligible for such certificates prior to August 31, 1987 and who applied for such certificates prior to July 1, 1988 or who would have been eligible for such certificates prior to August 31, 1987, but for one of the three-year experience requirement and who complete such requirement and apply for such certificate prior to August 31, 1988, will be valid for life.

Holders of valid continuing certificates affected by this subsection shall be entitled to have such certificate reissued and subject to the terms and conditions applicable to certification at the time of reissuance including the continuing education requirements of chapter 180-85 WAC.

(b) All continuing certificates not affected by the exception stated in (a) of this subsection shall lapse if the holder does not complete the continuing education requirement specified in chapter 180-85 WAC. To reinstate such a lapsed continuing certificate the individual must complete the requirements for reinstatement stated within chapter 180-85 WAC.

**AMENDATORY SECTION** (Amending WSR 92-04-044, filed 1/31/92, effective 3/2/92)

**WAC 180-79-115 ACADEMIC REQUIREMENTS FOR CERTIFICATION—TEACHERS.** Candidates for teachers' certificates shall complete the following requirements in addition to those set forth in WAC 180-75-080 and 180-75-085.

(1) Initial.

(a) Candidates for the initial certificate who apply for such certificate on or before August 31, 1992, shall hold a baccalaureate degree from a regionally accredited college or university and shall have completed the degree major in an academic field or in the teaching specialization of early childhood, elementary, reading, or special education.

(b) Candidates for the initial certificate who apply for such certificate after August 31, 1992, shall hold an approved baccalaureate degree from a regionally accredited college or university: PROVIDED, That if the approved baccalaureate degree is in early childhood education, elementary education, or special education, the candidate also must have at least thirty quarter hours (twenty semester hours) in one of the academic fields listed in WAC 180-79-080 (3)(a) through (e) and (4).

(2) Continuing.

(a) Candidates who apply for a continuing certificate (~~on or before August 31, 1992;~~) shall have at least forty-five quarter hours (thirty semester hours) of upper division and/or graduate work completed subsequent to the conferral of the baccalaureate degree: PROVIDED, That if the individual is pursuing study in a new subject matter area or specialization, lower division courses in that subject area or specialization shall be accepted toward continuing certification upon completion of the requirements for an endorsement in that subject area or specialization.

(b) (~~Candidates who apply for a continuing certificate after August 31, 1992, shall have completed an approved masters degree:~~

~~(c))~~ Candidates for a continuing certificate shall have been granted at least two subject area endorsements.

~~((c))~~ (c) Candidates who apply for a continuing certificate after August 31, 1992, who have not successfully completed course work or an in-service program including a minimum of ten clock hours of instruction on issues of abuse, must complete such course work or in-service program as a condition for the issuance of a continuing certificate. The content of the course work or in-service program shall discuss the identification of physical, emotional, sexual, and substance abuse, information on the impact of abuse on the behavior and learning abilities of students, discussion of the responsibilities of a teacher to report abuse or provide assistance to students who are the victims of abuse, and methods for teaching students about abuse of all types and their prevention.

**AMENDATORY SECTION** (Amending WSR 90-22-002, filed 10/25/90 and 11/20/90, effective 11/25/90 and 12/21/90)

**WAC 180-79-117 EXPERIENCE REQUIREMENT FOR CONTINUING CERTIFICATION—TEACHERS.** In addition to the academic requirements specified in WAC 180-79-115, candidates for continuing teachers' certificates shall provide, as a condition for the issuance of a continuing certificate, documentation of one hundred eighty days or full time equivalent or more satisfactory teaching experience with an authorized employer—i.e., school district, state agency, college or university, private school, or private school system—and at least thirty days of such employment with the same employer. (~~The requirements set forth in this section shall expire August 31, 1992.~~)

**AMENDATORY SECTION** (Amending WSR 90-22-002, filed 10/25/90, effective 11/25/90)

**WAC 180-79-122 EXPERIENCE REQUIREMENT FOR INITIAL ENDORSEMENT—PRINCIPALS.** In addition to the academic requirements specified in WAC 180-79-120(2), candidates for initial administrator's certificate with a principal's endorsement, as a condition for the issuance of such endorsement, documentation of one hundred eighty days or full time equivalent or more teaching experience with an authorized employer—i.e., school district, state agency, college or university, private school, or private school system—and at least thirty days of such employment with the same employer. (~~The requirements set forth in this section shall expire August 31, 1992.~~)

**AMENDATORY SECTION** (Amending WSR 92-04-044, filed 1/31/92, effective 3/2/92)

**WAC 180-79-123 EXPERIENCE REQUIREMENT FOR CONTINUING CERTIFICATION—ADMINISTRATORS.** In addition to the academic requirements specified in WAC 180-79-120, candidates for continuing administrator certificates shall provide, as a condition for issuance of a continuing certificate, documentation of one hundred eighty days or full time equivalent or more employment in the respective role with an authorized employer—i.e., school district, educational service district, state agency, college or university, private school, or private school system—and at least thirty days of such employment with the same employer. (~~The requirements set forth in this section shall expire August 31, 1992.~~)

**AMENDATORY SECTION** (Amending WSR 90-22-002, filed 10/25/90, effective 11/25/90)

**WAC 180-79-127 EXPERIENCE REQUIREMENT FOR CONTINUING CERTIFICATION—ESAS.** In addition to the academic requirements specified in WAC 180-79-179, candidates for continuing educational staff associate certificates shall provide, as a condition for issuance of a continuing certificate, documentation of one hundred eighty days or full time equivalent or more employment in the respective role with an authorized employer—i.e., school district, educational service district, state agency, college or university, private school, or private school system—and at least thirty days of such employment with the same employer. (~~The requirements set forth in this section shall expire August 31, 1992.~~)

**WSR 92-15-099**  
**PERMANENT RULES**  
**DEPARTMENT OF**  
**LABOR AND INDUSTRIES**  
[Filed July 20, 1992, 11:44 a.m.]

Date of Adoption: July 20, 1992.

Purpose: To change requirements for proof of emancipation, to add proof of emancipation to the record-keeping requirement, and to clarify the department's authority to enter, inspect, and interview employees on the job site.

Citation of Existing Rules Affected by this Order: Amending WAC 296-131-120 and 296-131-130.

Statutory Authority for Adoption: RCW 49.30.030 and 43.22.310.

Pursuant to notice filed as WSR 92-10-078 on May 6, 1992.

Effective Date of Rule: Thirty-one days after filing.

July 20, 1992  
Joseph A. Dear  
Director

**NEW SECTION**

WAC 296-131-006 AUTHORITY TO ENTER, INSPECT, AND INVESTIGATE PLACES OF EMPLOYMENT AND RECORDS, AND TO CONDUCT INTERVIEWS. In order to carry out the purposes of this chapter, the director or the director's authorized representative is authorized:

(1) To enter without delay any work site or area or other environment where work is performed by an employee or where employment records are, or are required to be, maintained; and

(2) To inspect, transcribe, and copy all pertinent records, and to inspect and investigate any such place of employment and all pertinent conditions, structures, machines, apparatus, devices, equipment, and materials therein, and to question privately any employer, owner, operator, agent, or employee.

**AMENDATORY SECTION** (Amending WSR 90-14-038, filed 6/29/90, effective 11/1/90)

WAC 296-131-120 HOURS OF WORK FOR MINORS IN AGRICULTURE. (1) Minors legally required to attend school may not be employed during school hours except by special permission from school officials as provided in RCW 28A.27.010 and 28A.27.090.

(2)(a) Minors under the age of sixteen may work up to three hours a day on school days, up to eight hours a day on nonschool days and up to twenty-one hours a week during weeks when school is in session. Minors under the age of sixteen may work up to eight hours a day and up to forty hours a week during weeks when school is not in session.

(b) Except as otherwise provided, on days when school is in session, minors under the age of sixteen may not be employed before 7:00 a.m. nor after 8:00 p.m. On days when school is not in session, minors under the age of sixteen may not be employed before 5:00 a.m. nor after 9:00 p.m. On days when school is in session, minors under the age of sixteen employed in animal agriculture or whose employment in crop production requires daily attention to irrigation, may be employed beginning at 6:00 a.m.

(3)(a) Minors who are sixteen and seventeen years of age may work up to twenty-eight hours a week, up to four hours a day on school days and up to eight hours a day on nonschool days during weeks when school is in session. Minors who are sixteen and seventeen years of age may work up to ten hours per day and up to fifty hours per week during weeks when school is not in session. Minors who are sixteen and seventeen years of age may work up to sixty hours per week in the mechanical harvest of peas, wheat, and hay during weeks when school is not in session.

(b) Minors who are sixteen and seventeen years of age may not be employed before 5:00 a.m. nor after 10:00 p.m. Minors who are sixteen and seventeen years of age may not work later than 9:00 p.m. on more than two consecutive nights preceding a school day.

(4) Except for minors employed in dairy or livestock production, in the harvest of hay, or whose employment

in crop production requires daily attention to irrigation, no minor shall be employed more than six days in any one week.

(5) The provisions of this section shall not apply to minors sixteen years of age and older who (~~are emancipated by court order~~) can demonstrate emancipation by either (a) providing a marriage certificate as proof of marriage, or (b) providing a birth certificate that names the minor as a parent. Copies of such documents must be retained by the employer for one year, pursuant to the requirements of WAC 296-131-130.

**AMENDATORY SECTION** (Amending WSR 90-14-038, filed 6/29/90, effective 11/1/90)

WAC 296-131-130 RECORDKEEPING. In addition to the records required under WAC 296-131-017, an employer is responsible for obtaining and keeping on file for one year the following information concerning each minor employee:

(1) Proof of age by means of a copy of one of the following: Birth certificate; driver's license; baptismal record; Bible record; insurance policy at least one year old indicating the date of birth; ((or)) witnessed statement of the parent or guardian; or a completed federal employment eligibility verification (Form I-9);

(2) Parental authorization required by WAC 296-131-105;

(3) School authorization required by WAC 296-131-105;

(4) Documentation of emancipation as provided by WAC 296-131-120(5).

Every employer shall make the records described in this section available to the director or the director's authorized representative at any time for inspection and transcription or copying and to the employee, upon request for that employee's work record, at any reasonable time.

**WSR 92-15-100**  
**PROPOSED RULES**  
**DEPARTMENT OF**  
**LABOR AND INDUSTRIES**  
[Filed July 20, 1992, 11:45 a.m.]

Continuance of WSR 92-12-093 and 92-14-115.

Title of Rule: Chapter 296-125 WAC, Nonagricultural employment of minors.

Purpose: The purpose of this rule is to clarify language in existing WACs; to increase protection of health and safety of minors as mandated by chapter 49.12 RCW; and to effect better school attendance as mandated by chapter 49.12 RCW. The purpose of this supplemental notice is to add an additional hearing in Pasco.

Hearing Location: Franklin County PUD Auditorium, 1411 West Clark, Pasco, WA, on August 25, 1992, at 1:00 p.m.

Submit Written Comments to: Mark M. McDermott, P.O. Box 44500, Olympia, WA 98504-4500, by August 25, 1992.

Date of Intended Adoption: September 15, 1992.  
July 20, 1992  
Joseph A. Dear  
Director

**WSR 92-15-101**  
**PROPOSED RULES**  
**OFFICE OF**  
**INSURANCE COMMISSIONER**  
[Filed July 20, 1992, 3:50 p.m.]

Original Notice.

Title of Rule: Accounting for salvage and subrogation recoveries, annual statement.

Purpose: Change the requirement for accounting for salvage and subrogation recoveries in annual statements.

Other Identifying Information: Insurance Commissioner Matter No. R 92-11.

Statutory Authority for Adoption: RCW 48.02.060.

Statute Being Implemented: RCW 48.05.250.

Summary: Repeal the regulation, which now requires that insurers take credit on annual statements for salvage and subrogation only when reduced to cash.

Reasons Supporting Proposal: Reflect change in National Association of Insurance Commissioners model regulation, and reflect the reality that the recovery of some salvage or subrogation is a virtual certainty in many cases and that frequently such credits are taken in other ways.

Name of Agency Personnel Responsible for Drafting: George W. Taylor, Jr., Insurance Building, Olympia, Washington, (206) 753-7306; Implementation and Enforcement: John B. Woodall, Insurance Building, Olympia, Washington, (206) 753-7303.

Name of Proponent: Dick Marquardt, Insurance Commissioner, governmental.

Rule is not necessitated by federal law, federal or state court decision.

Explanation of Rule, its Purpose, and Anticipated Effects: The repeal will permit insurers to take credit for anticipated subrogation and salvage.

Proposal Changes the Following Existing Rules: It repeals the existing regulation.

No small business economic impact statement is required for this proposal by chapter 19.85 RCW.

A small business economic impact statement is not required. This change in the rule will have no adverse economic impact on business. This repealer merely changes the requirements for a specific, narrow element in the financial reports already required of insurers. Moreover, this change reflects a revision expected to be made in the standards issued by the National Association of Insurance Commissioners; insurers doing business in other states will be expected to comply with the new requirement, and this repealer will avoid their having to meet a more strict requirement in Washington. Furthermore, insurers complete those financial reports in accordance with instructions promulgated by the national association; thus, if the national association does not change the requirements, the proposed repealer will have

no effect because the standing instructions for the reports will still require the present treatment.

Hearing Location: Insurance Commissioner's Office, Insurance Building, Conference Room, Olympia, Washington, on August 25, 1992, at 9:00 a.m.

Submit Written Comments to: Insurance Commissioner, Insurance Building, P.O. Box 40255, Olympia, WA 98504-0255, by August 24, 1992.

Date of Intended Adoption: November 1, 1992.

July 20, 1992  
Dick Marquardt  
Insurance Commissioner  
by John B. Woodall  
Deputy Insurance Commissioner

REPEALER

The following section of the Washington Administrative Code is repealed:

WAC 284-16-050 ACCOUNTING FOR SALVAGE AND SUBROGATION RECOVERIES, ANNUAL STATEMENT.

**WSR 92-15-102**  
**PROPOSED RULES**  
**OFFICE OF**  
**INSURANCE COMMISSIONER**  
[Filed July 20, 1992, 3:52 p.m.]

Original Notice.

Title of Rule: Standards the insurance commissioner will apply in determining if an insurer's condition is hazardous and in correcting the condition.

Purpose: To identify conditions of insurers that the commissioner will consider in determining whether the continued transaction of insurance in this state would be hazardous to policyholders, creditors or the general public, and outline the corrective action the commissioner may require.

Other Identifying Information: Insurance Commissioner Matter No. R 92-9.

Statutory Authority for Adoption: RCW 48.02.060.

Statute Being Implemented: RCW 48.05.140, 48.03-.030 and 48.31.030.

Summary: Identifies hazardous conditions of insurers, how they will be evaluated by the insurance commissioner, and what action may be taken by the commissioner with respect thereto.

Reasons Supporting Proposal: Will enhance the regulation of insurance with respect to insurer's solvency and solidity and will promote regulatory uniformity by the adoption of rules based upon a model regulation of the National Association of Insurance Commissioners.

Name of Agency Personnel Responsible for Drafting: Robert E. Johnson, Insurance Building, Olympia, Washington, (206) 753-2406; Implementation and Enforcement: John B. Woodall, Insurance Building, Olympia, Washington, (206) 753-7303.

Name of Proponent: Dick Marquardt, Insurance Commissioner, governmental.

Rule is not necessitated by federal law, federal or state court decision.

Explanation of Rule, its Purpose, and Anticipated Effects: The rules are based on a model regulation adopted by the National Association of Insurance Commissioners (NAIC) and is one of the regulations states must have in order to be "accredited" by the NAIC as having adequate insurer solvency standards. The adoption of the rules will not only identify to insurers the standards relative to being found to be in a hazardous condition, but will speed the day that Washington state is fully accredited by the NAIC.

Proposal does not change existing rules.

No small business economic impact statement is required for this proposal by chapter 19.85 RCW.

A small business economic impact statement is not required because the rules require no action by business and there are no direct costs necessary for a business to comply with the rules. The rules outline standards the insurance commissioner considers in determining whether the operation of an insurer is hazardous to policyholders, creditors or the general public. They also identify corrective action the commissioner may apply, as appropriate to a given situation. Such standards and actions are available apart from the rules and impose no new burdens upon insurers. The rules serve to highlight existing laws and the responsibilities and authority of insurers and the commissioner thereunder, and serve as guides to insurers as to conditions and practices to be avoided and possible corrective responses they can anticipate in the exercise of the commissioner's discretion. It is not feasible to vary the rules with respect to a "small business" because the number of employees—fifty or fewer—has little relationship to the elements of financial solvency dealt with in the rules. To the extent it may be pertinent, the commissioner would give due consideration in the exercise of proper discretion in applying the rules.

Hearing Location: John L. Cherberg Building, Hearing Room #1, State Capitol Campus, 14th and Water Streets, Olympia, Washington, on August 27, 1992, at 9:30 a.m.

Submit Written Comments to: Insurance Commissioner, Insurance Building, P.O. Box 40255, Olympia, WA 98504-0255, by August 27, 1992.

Date of Intended Adoption: September 3, 1992.

July 20, 1992

Dick Marquardt

Insurance Commissioner

by Robert E. Johnson

Deputy Insurance Commissioner

#### NEW SECTION

WAC 284-16-300 PURPOSE. (1) The purpose of this regulation, WAC 284-16-300 through 284-16-320 is to set forth the standards which the commissioner will use to identify insurers in such condition as to render the continuance of their business hazardous to the public or to holders of their policies or certificates of insurance.

(2) This regulation shall not be interpreted to limit the powers granted the commissioner by any laws or parts of laws of this state, nor shall this regulation be interpreted to supersede any laws or parts of laws of this state.

#### NEW SECTION

WAC 284-16-310 STANDARDS. The following standards, either singly or a combination of two or more, may be considered by the

commissioner to determine whether the continued operation of any insurer transacting an insurance business in this state might be deemed to be hazardous to the policyholders, creditors, or the general public. The commissioner may consider:

(1) Adverse findings reported in financial condition and market conduct examination reports.

(2) The National Association of Insurance Commissioners Insurance Regulatory Information System and its related reports.

(3) The ratios of commission expense, general insurance expense, policy benefits and reserve increases as to annual premium and net investment income which could lead to an impairment of capital and surplus.

(4) The insurer's asset portfolio when viewed in light of current economic conditions is not of sufficient value, liquidity, or diversity to assure the company's ability to meet its outstanding obligations as they mature.

(5) The ability of an assuming reinsurer to perform and whether the insurer's reinsurance program provides sufficient protection for the company's remaining surplus after taking into account the insurer's cash flow and the classes of business written as well as the financial condition of the assuming reinsurer.

(6) The insurer's operating loss in the last twelve month period or any shorter period of time, including but not limited to net capital gain or loss, change in nonadmitted assets, and cash dividends paid to shareholders, is greater than fifty percent of such insurer's remaining surplus as regards policyholders in excess of the minimum required.

(7) Whether any affiliate, subsidiary, or reinsurer is insolvent, threatened with insolvency, or delinquent in payment of its monetary or other obligation.

(8) Contingent liabilities, pledges, or guaranties which either individually or collectively involve a total amount which in the opinion of the commissioner may affect the solvency of the insurer.

(9) Whether any controlling person of an insurer is delinquent in the transmitting to, or payment of, net premiums to such insurer.

(10) The age and collectibility of receivables.

(11) Whether the management of an insurer, including officers, directors, or any other person who directly or indirectly controls the operation of such insurer, fails to possess and demonstrate the competence, fitness, and reputation deemed necessary to serve the insurer in such position.

(12) Whether management of an insurer has failed to respond to inquiries relative to the condition of the insurer or has furnished misleading information concerning an inquiry.

(13) Whether management of an insurer either has filed any false or misleading sworn financial statement, or has released false or misleading financial statement to lending institutions or to the general public, or has made a false or misleading entry, or has omitted an entry of material amount in the books of the insurer.

(14) Whether the insurer has grown so rapidly and to such an extent that it lacks adequate financial and administrative capacity to meet its obligations in a timely manner.

(15) Whether the company has experienced or will experience in the foreseeable future, cash flow and/or liquidity problems.

#### NEW SECTION

WAC 284-16-320 MANNER IN WHICH COMMISSIONER WILL EXERCISE AUTHORITY. (1) For the purpose of making a determination of an insurer's financial condition under this regulation, the commissioner may:

(a) Disregard any credit or amount receivable resulting from transactions with a reinsurer which is insolvent, impaired, or otherwise subject to a delinquency proceeding;

(b) Make appropriate adjustments to asset values attributable to investments in or transactions with parents, subsidiaries, or affiliates;

(c) Refuse to recognize the stated value of accounts receivable if the ability to collect receivables is highly speculative in view of the age of the account or the financial condition of the debtor; or

(d) Increase the insurer's liability in an amount equal to any contingent liability, pledge, or guarantee not otherwise included if there is a substantial risk that the insurer will be called upon to meet the obligation undertaken within the next twelve-month period.

(2) If the commissioner determines that the continued operation of the insurer authorized to transact business in this state may be hazardous to the policyholders or the general public, then the commissioner may, in conjunction with or in lieu of a notice required or permitted by RCW 48.05.150, issue an order requiring the insurer to:



- (a) Reduce the total amount of present and potential liability for policy benefits by reinsurance;
- (b) Reduce, suspend, or limit the volume of business being accepted or renewed;
- (c) Reduce general insurance and commission expenses by specified methods;
- (d) Increase the insurer's capital and surplus;
- (e) Suspend or limit the declaration and payment of dividend by an insurer to its stockholders or to its policyholders;
- (f) File reports in a form acceptable to the commissioner concerning the market value of an insurer's assets;
- (g) Limit or withdraw from certain investments or discontinue certain investment practices to the extent the commissioner deems necessary;
- (h) Document the adequacy of premium rates in relation to the risks insured; or
- (i) File, in addition to regular annual statements, interim financial reports on the form adopted by the National Association of Insurance Commissioners or on such format as promulgated by the commissioner.

If the insurer is a foreign insurer, the commissioner's order may be limited to the extent provided by statute.

(3) Any insurer subject to an order under subsection (2) of this section may make a written demand for a hearing, subject to the requirements of RCW 48.04.010, by specifying in what respects it is aggrieved and the grounds to be relied upon as basis for the relief to be demanded at the hearing.

**WSR 92-15-103**  
**PROPOSED RULES**  
**OFFICE OF**  
**INSURANCE COMMISSIONER**

[Filed July 20, 1992, 3:55 p.m.]

**Original Notice.**

**Title of Rule:** Washington minimum reserve standards for individual and group disability insurance.

**Purpose:** To establish minimum reserve standards to be met by insurers with respect to disability insurance contracts, consistent with standards formulated by the National Association of Insurance Commissioners (NAIC).

**Other Identifying Information:** Insurance Commissioner Matter No. R 92-8.

**Statutory Authority for Adoption:** RCW 48.02.060.

**Statute Being Implemented:** RCW 48.12.030 and 48.12.060.

**Summary:** Proposes adoption of NAIC model rules relative to reserve standards for group and individual disability insurance contracts.

**Reasons Supporting Proposal:** Assures that insurers will be able to measure and meet their contractual obligations under disability insurance policies, and establishes standards and procedures consistent with the uniform requirements of the NAIC.

**Name of Agency Personnel Responsible for Drafting:** James E. Tompkins and Robert E. Johnson, Olympia, Washington, (206) 586-3787; **Implementation and Enforcement:** John B. Woodall, Insurance Building, Olympia, Washington, (206) 753-7303.

**Name of Proponent:** Dick Marquardt, Insurance Commissioner, governmental.

**Rule is not necessitated by federal law, federal or state court decision.**

**Explanation of Rule, its Purpose, and Anticipated Effects:** These rules would adopt the uniform rules formulated by the National Association of Insurance Commissioners (NAIC) with respect to minimum reserve standards for individual and group disability insurance contracts. They will provide added assurance that insurers will be able to meet their disability insurance contract obligations. An additional effect will be to hasten the day when Washington state is fully accredited by the NAIC as being a state that is capable of regulating the fiscal solvency of insurers.

**Proposal Changes the Following Existing Rules:** Repeals WAC 284-16-060 and substitutes therefor the current standards formulated by the NAIC, as contemplated by RCW 48.12.030.

No small business economic impact statement is required for this proposal by chapter 19.85 RCW.

All disability insurers, large and small, are now required to maintain reserves for their disability insurance contracts. These rules merely update the standards, in some cases resulting in less reserves being required. The rules will have a minor or negligible economic impact. One reason for the adoption of these rules is that it will give Washington state the standards the National Association of Insurance Commissioners requires in order for the state to be "certified" as capable of ensuring the solvency of insurers. All states are moving toward "certification," so that insurers will be subjected to the same requirements, including those imposed by the proposed rules, regardless of their state of domicile. Most insurers transacting insurance in our state also do so in other states and will thereby become subject to identical standards.

**Hearing Location:** John L. Cherberg Building, Hearing Room #1, State Capitol Campus, 14th and Water Streets, Olympia, Washington, on August 27, 1992, at 9:30 a.m.

**Submit Written Comments to:** Insurance Commissioner, Insurance Building, P.O. Box 40255, Olympia, WA 98504-0255, by August 27, 1992.

**Date of Intended Adoption:** September 3, 1992.

July 20, 1992

Dick Marquardt

Insurance Commissioner

by Robert E. Johnson

Deputy Insurance Commissioner

**NEW SECTION**

WAC 284-16-400 TITLE AND SCOPE. (1) This regulation, WAC 284-16-400 through WAC 284-16-540, shall be known and may be cited as the "Washington minimum reserve standards for individual and group disability insurance contracts regulation."

(2) These standards apply to all individual and group disability insurance coverages except medicare supplement insurance as governed by WAC 284-66-210.

**NEW SECTION**

WAC 284-16-410 DEFINITIONS. For the purpose of this regulation, the following definitions shall apply:

(1) "Annual-claim cost" means the net annual cost per unit of benefit before the addition of expense including claim settlement expenses, and a margin for profit or contingencies. For example, the annual claim cost for a one hundred dollar monthly disability benefit, for a maximum disability benefit period of one year, with an elimination period of one week, with respect to a male at age thirty-five, in a certain



occupation might be twelve dollars, while the gross premium for this benefit might be eighteen dollars. The additional six dollars would cover expense and profit or contingencies.

(2) "Claims accrued" means that portion of claims incurred on or prior to the valuation date which result in liability of the insurer for the payment of benefits for medical services which have been rendered on or prior to the valuation date, and for the payment of benefits for days of hospitalization and days of disability which have occurred on or prior to the valuation date, which the insurer has not paid as of the valuation date, but for which it is liable, and will have to pay after the valuation date. This liability is sometimes referred to as a liability for accrued benefits. A claim reserve, which represents an estimate of this accrued claim liability, must be established.

(3) "Claims incurred" means that portion of a claim for which the insurer has become obligated to make payment, on or prior to the valuation date.

(4) "Claims reported" means those claims that have been incurred on or prior to the valuation date of which the insurer has been informed, on or prior to the valuation date. These claims are considered as reported claims for annual statement purposes.

(5) "Claims unaccrued" means that portion of claims incurred on or prior to the valuation date which result in liability of the insurer for the payment of benefits for medical services expected to be rendered after the valuation date, and for benefits expected to be payable for days of hospitalization and days of disability occurring after the valuation date. This liability is sometimes referred to as a liability for unaccrued benefits. A claim reserve, which represents an estimate of the unaccrued claim payments expected to be made, which may or may not be discounted with interest, must be established.

(6) "Claims unreported" means those claims that have been incurred on or prior to the valuation date of which the insurer has not been informed, on or prior to the valuation date. These claims are considered as unreported claims for annual statement purposes.

(7) "Date of disablement" means the earliest date the insured is considered as being disabled under the definition of disability in the contract, based on a doctor's evaluation or other evidence. Normally this date will coincide with the start of any elimination period.

(8) "Elimination period" means a specified number of days, weeks, or months starting at the beginning of each period of loss, during which no benefits are payable.

(9) "Gross premium" is the amount of premium charged by the insurer. It includes the net premium, based on claim-cost, for the risk, together with any loading for expenses, profit, or contingencies.

(10) "Group insurance" includes blanket disability insurance.

(11) "Level premium" means a premium calculated to remain unchanged throughout either the lifetime of the policy, or for some shorter projected period of years. The premium need not be guaranteed; in which case, although it is calculated to remain level, it may be changed if any of the assumptions on which it was based are revised at a later time. Generally, the annual claim costs are expected to increase each year and the insurer, instead of charging premiums that correspondingly increase each year, charges a premium calculated to remain level for a period of years or for the lifetime of the contract. In this case the benefit portion of the premium is more than needed to provide for the cost of benefits during the earlier years of the policy and less than the actual cost in the later years. The building of a prospective contract reserve is a natural result of level premiums.

(12) "Long-term care insurance" means any insurance policy or benefit contract primarily advertised, marketed, offered, or designed to provide coverage or services over a prolonged period of time for either institutional or community-based convalescent, custodial, chronic, or terminally ill care. Long-term care insurance may be issued by insurers; fraternal benefit societies; health care service contractors; health maintenance organizations or any similar organization to the extent they are authorized. Long-term care insurance shall not include any insurance policy which is offered primarily to provide basic Medicare supplement coverage, nor shall it include a contract between a continuing care retirement community and its residents.

(13) "Modal premium" means the premium paid on a contract based on a premium term which could be annual, semi-annual, quarterly, monthly, or weekly. Thus if the annual premium is one hundred dollars and if, instead, monthly premiums of nine dollars are paid then the modal premium is nine dollars.

(14) "Negative reserve" means a negative terminal reserve value. Negative reserves occur when the present value of future benefits is less than the present value of future valuation net premiums.

(15) "Preliminary term reserve method" means the method of valuation for which the valuation net premium for each year falling within the preliminary term period is exactly sufficient to cover the expected incurred claims of that year, so that the terminal reserves will be zero at the end of the year. As of the end of the preliminary term period, a new constant valuation net premium, or stream of changing valuation premiums, becomes applicable such that the present value of all such premiums is equal to the present value of all claims expected to be incurred following the end of the preliminary term period.

(16) "Present value of amounts not yet due on claims" means the reserve for claims unaccrued which may be discounted at interest.

(17) "Reserve" includes all items of benefit liability, whether in the nature of incurred claim liability or in the nature of contract liability relating to future periods of coverage, and whether the liability is accrued or unaccrued. An insurer under its contracts promises benefits which result in:

(a) Claims which have been incurred, that is, for which the insurer has become obligated to make payment, on or prior to the valuation date. On these claims, payments expected to be made after the valuation date for accrued and unaccrued benefits are liabilities of the insurer which should be provided for by establishing claim reserves; or

(b) Claims which are expected to be incurred after the valuation date. Any present liability of the insurer for these future claims should be provided for by the establishment of contract reserves and unearned premium reserves.

(18) "Terminal reserve" means the reserve at the end of a contract year, which is the present value of benefits expected to be incurred after that contract year minus the present value of future valuation net premiums.

(19) "Unearned premium reserve" means that portion of the premium paid or due to the insurer which is applicable to the period of coverage extending beyond the valuation date. Thus if an annual premium of one hundred twenty dollars was paid on November 1, twenty dollars would be earned as of December 31 and the remaining one hundred dollars would be unearned. The unearned premium reserve could be on a gross basis as in this example, or on a valuation net premium basis.

(20) "Valuation net modal premium" means the modal fraction of the valuation net annual premium that corresponds to the gross modal premium in effect on any contract to which contract reserves apply. Thus if the mode of payment in effect is quarterly, the valuation net modal premium is the quarterly equivalent of the valuation net annual premium.

#### NEW SECTION

WAC 284-16-420 RESERVES IN EXCESS OF MINIMUM RESERVE STANDARDS. When an insurer determines that adequacy of its disability insurance reserves requires reserves in excess of the minimum standards specified herein, such increased reserves shall be held and shall be considered the minimum reserves for that insurer.

#### NEW SECTION

WAC 284-16-430 PROSPECTIVE GROSS PREMIUM VALUATION. (1) With respect to any block of contracts, or with respect to an insurer's disability business as a whole, a prospective gross premium valuation is the ultimate test of reserve adequacy as of a given valuation date. The gross premium valuation shall take into account, for contracts in force, in a claims status, or in a continuation of benefits status on the valuation date, the present value as of the valuation date, adjusted for future premium increases reasonably expected to be put into effect, of:

- (a) All expected benefits unpaid;
- (b) All expected expenses unpaid; and
- (c) All unearned or expected premiums.

(2) The insurer shall perform gross premium valuation whenever a significant doubt exists as to reserve adequacy with respect to any major block of contracts, or with respect to the insurer's disability business as a whole. In the event inadequacy is found to exist, the insurer shall make immediate loss recognition and restore the reserves to adequacy. The insurer shall hold adequate reserves, inclusive of claim, premium and contract reserves, if any, with respect to all contracts, regardless of whether contract reserves are required for such contracts under these standards.

(3) Whenever minimum reserves, as defined in these standards, exceed reserve requirements as determined by a prospective gross premium valuation, such minimum reserves remain the minimum requirement under these standards.

**NEW SECTION**

**WAC 284-16-440 GENERAL CLAIM RESERVE REQUIREMENTS.** (1) Claim reserves are required for all incurred but unpaid claims on all disability insurance policies;

(2) Appropriate claim expense reserves are required with respect to the estimated expense of settlement of all incurred but unpaid claims; and

(3) All such reserves for prior valuation years are to be tested for adequacy and reasonableness along the lines of claim runoff schedules in accordance with the statutory financial statement including consideration of any residual unpaid liability.

**NEW SECTION**

**WAC 284-16-450 MINIMUM STANDARDS FOR CLAIM RESERVES.** (1) For disability income:

(a) The maximum interest rate for claim reserves is specified in WAC 284-16-520.

(b) Minimum standards with respect to morbidity are those specified in WAC 284-16-500 and 284-16-510; except that, at the option of the insurer, for claims with a duration from date of disablement of less than two years, reserves may be based on the insurer's experience, if such experience is considered credible, or upon other assumptions designed to place a sound value on the liabilities.

(c) For contracts with an elimination period, the insurer shall measure the duration of disablement as dating from the time that benefits would have begun to accrue had there been no elimination period.

(2) For all other benefits:

(a) The maximum interest rate for claim reserves is specified in WAC 284-16-520.

(b) The insurer shall base the reserve on the insurer's morbidity experience, if such experience is considered credible, or upon other assumptions designed to place a sound value on the liabilities.

(c) General claim reserve methods are as follows:

(i) The insurer may use any generally accepted or reasonable actuarial method or combination of methods to estimate all claim liabilities.

(ii) The methods used for estimating liabilities generally may be aggregate methods, or various reserve items may be separately valued. The insurer may also employ approximations based on groupings and averages. The insurer shall, however, determine adequacy of the claim reserves in the aggregate.

**NEW SECTION**

**WAC 284-16-460 PREMIUM RESERVES.** (1) General premium reserve requirements are:

(a) Unearned premium reserves are required for all contracts, including credit insurance disability contracts, with respect to the period of coverage for which premiums, other than premiums paid in advance, have been paid beyond the date of valuation;

(b) If premiums due and unpaid are carried as an asset, the insurer shall treat the premiums as premiums in force, subject to unearned premium reserve determination. The insurer shall carry as an offsetting liability the value of unpaid commissions, premium taxes, and the cost of collection associated with due and unpaid premiums; and

(c) Insurers may appropriately discount to the valuation date the gross premiums paid in advance for a period of coverage commencing after the next premium due date which follows the date of valuation. The insurer shall hold this discounted premium either as a separate liability or as an addition to the unearned premium reserve which would otherwise be required as a minimum.

(2) Minimum standards for unearned premium reserves are as follows:

(a) The minimum unearned premium reserve with respect to any contract is the pro rata unearned modal premium that applies to the premium period beyond the valuation date, with such premium determined on the basis of:

(i) The valuation net modal premium on the contract reserve basis applying to the contract; or

(ii) The gross modal premium for the contract if no contract reserve applies.

(b) However, in no event may the sum of the unearned premium and contract reserves for all contracts of the insurer subject to contract reserve requirements be less than the gross modal unearned premium reserve on all such contracts, as of the date of valuation. Such reserve shall never be less than the expected claims for the period beyond the

valuation date represented by such unearned premium reserve, to the extent not provided for elsewhere.

(3) General premium reserve methods are as follows: In computing premium reserves, the insurer may employ suitable approximations and estimates; including, but not limited to groupings, averages, and aggregate estimation. The insurer shall periodically test the approximations or estimates to determine their continuing adequacy and reliability.

**NEW SECTION**

**WAC 284-16-470 CONTRACT RESERVES.** (1) General contract reserve requirements are:

(a) Contract reserves are required, unless otherwise specified in (b) of this subsection for:

(i) All individual and group contracts with which level premiums are used; or

(ii) All individual and group contracts with respect to which, due to the gross premium pricing structure at issue, the value of the future benefits at any time exceeds the value of any appropriate future valuation net premiums at that time. The insurer shall determine the values specified in this item (ii) on the basis specified in subsection (2) of this section.

(b) Contracts not requiring a contract reserve are:

(i) Contracts which cannot be continued after one year from issue; or

(ii) Contracts already in force on the effective date of these standards for which no contract reserve was required under the immediately preceding standards.

(c) The contract reserve is in addition to claim reserves and premium reserves; and

(d) The insurer shall use methods and procedures for contract reserves that are consistent with those for claim reserves for any contract, or else shall make appropriate adjustment when necessary to assure provision for the aggregate liability. The insurer shall use the same definition of the date of incurral in both determinations.

(2) The basis for determining minimum standards for contract reserves are:

(a) Minimum standards with respect to morbidity are those set forth in WAC 284-16-500 and 284-16-510. Valuation net premiums used under each contract must have a structure consistent with the gross premium structure at issue of the contract as this relates to advancing age of insured, contract duration and period for which gross premiums have been calculated. The insurer shall value contracts for which tabular morbidity standards are not specified in WAC 284-16-500 and 284-16-510 using tables established for reserve purposes by a qualified actuary and acceptable to the commissioner.

(b) The maximum interest rate is specified in WAC 284-16-520.

(c) The insurer shall use termination rates in the computation of reserves on the basis of a mortality table as specified in WAC 284-16-530 except as noted in (d) of this subsection.

(d) Under contracts for which premium rates are not guaranteed, and where the effects of insurer underwriting are specifically used by policy duration in the valuation morbidity standard, the insurer may use total termination rates at ages and durations where these exceed specified mortality table rates, but not in excess of the lesser of:

(i) Eighty percent of the total termination rate used in the calculation of the gross premiums; or

(ii) Eight percent.

(e) Where a morbidity standard specified in WAC 284-16-500 and 284-16-510 is on an aggregate basis, the insurer may adjust the morbidity standard to reflect the effect of insurer underwriting by policy duration. The adjustments shall be appropriate to the underwriting and be acceptable to the commissioner.

(f) Reserve method:

(i) For insurance, except long-term care and Medicare supplement insurance, the minimum reserve is the reserve calculated on the two-year full preliminary term method; that is, under which the terminal reserve is zero at the first and also the second contract anniversary.

(ii) For long-term care insurance and medicare supplemental insurance as governed by WAC 284-66-210 the minimum reserve is the reserve calculated on the one-year full preliminary term method.

(g) The preliminary term method may be applied only in relation to the date of issue of a contract. Reserve adjustments introduced later, as a result of rate increases, revisions in assumptions or for other reasons, are to be applied immediately as of the effective date of adoption of the adjusted basis.

(h) The insurer may offset negative reserves on any benefit against positive reserves for other benefits in the same contract, but the total contract reserve with respect to all benefits combined may not be less than zero.

(3) Provided the contract reserve on all contracts to which an alternative method or basis is applied is not less in the aggregate than the amount determined according to the applicable standards specified above; an insurer may use any reasonable assumptions as to interest rates, termination and/or mortality rates, and rates of morbidity or other contingency. Also, subject to the preceding condition, the insurer may employ methods other than the methods stated above in determining a sound value of its liabilities under such contracts, including, but not limited to the following:

- (a) The net level premium method;
- (b) The one-year full preliminary term method;
- (c) Prospective valuation on the basis of actual gross premiums with reasonable allowances for future expenses;
- (d) The use of approximations such as those involving age groupings, groupings of several years of issue, average amounts of indemnity, grouping of similar contract forms;
- (e) The computation of the reserve for one contract benefit as a percentage of, or by other relation to, the aggregate contract reserves exclusive of the benefit or benefits so valued; and
- (f) The use of a composite annual claim cost for all or any combination of the benefits included in the contracts valued.

(4) Tests for adequacy and reasonableness of contract reserves.

(a) Annually, the insurer shall make an appropriate review of the insurer's prospective contract liabilities on contracts valued by tabular reserves, to determine the continuing adequacy and reasonableness of the tabular reserves giving consideration to future gross premiums. The insurer shall make appropriate increments to such tabular reserves if such tests indicate that the basis of such reserves is no longer adequate; subject, however, to the minimum standards of subsection (2) of this section.

(b) If an insurer has a contract or a group of related similar contracts, for which future gross premiums will be restricted by contract, commissioner's regulation, or for some other reasons, such that the future gross premiums reduced by expenses for administration, commissions, and taxes will be insufficient to cover future claims, the insurer shall establish contract reserves for such shortfalls in the aggregate.

#### NEW SECTION

WAC 284-16-480 DETERMINATION OF ADEQUACY. The insurer shall determine the adequacy of its disability insurance reserves on the basis of the claim reserves, premium reserves, and contract reserves combined. However, these standards emphasize the importance of determining appropriate reserves for each of the three categories separately.

#### NEW SECTION

WAC 284-16-490 REINSURANCE. Increases to, or credits against reserves carried, arising because of reinsurance assumed or reinsurance ceded, must be determined in a manner consistent with these minimum reserve standards and with all applicable provisions of the reinsurance contracts which affect the insurer's liabilities.

#### NEW SECTION

WAC 284-16-500 SPECIFIC MINIMUM MORBIDITY STANDARDS FOR INDIVIDUAL DISABILITY CONTRACTS.

(1) Disability income benefits due to accident or sickness.

(a) Contract reserves for:

(i) Contracts issued on or after January 1, 1967, and prior to January 1, 1993: The 1964 Commissioners Disability Table (64 CDT).

(ii) Contracts issued on or after January 1, 1993: The 1985 Commissioners Individual Disability Tables A (85CIDA); or The 1985 Commissioners Individual Disability Tables B (85CIDB).

(iii) Contracts issued during 1986 through December 31, 1992: Optional use of either the 1964 Table or the 1985 Tables.

(iv) Each insurer shall elect, with respect to all individual contracts issued in any one statement year, either it will use Tables A or Tables B as the minimum standard. The insurer may, however, elect to use the other tables with respect to any subsequent statement year.

(b) Claim reserves: The minimum morbidity standard in effect for contract reserves on currently issued contracts, as of the date the claim is incurred.

(2) Hospital benefits, surgical benefits and maternity benefits (scheduled benefits or fixed time period benefits only).

(a) Contract reserves for:

(i) Contracts issued on or after January 1, 1967, and before January 1, 1993: The 1956 Intercompany Hospital-Surgical Tables.

(ii) Contracts issued on or after January 1, 1993: The 1974 Medical Expense Tables, Table A, Transactions of the Society of Actuaries, Volume XXX, pg. 63. Refer to the paper (in the same volume, pg. 9) to which this table is appended, including its discussions, for methods of adjustment for benefits not directly valued in Table A: "Development of the 1974 Medical Expense Benefits," Houghton and Wolf.

(iii) Contracts issued during 1986 through December 31, 1992: Optional use of the 1974 Medical Expenses Tables.

(b) Claim reserves: No specific standards. See subsection (5) of this section.

(3) Cancer expense benefits (scheduled benefits or fixed time period benefits only).

(a) Contract reserves for:

(i) Contracts issued on or after January 1, 1993: The 1985 NAIC Cancer Claim Cost Tables.

(ii) Contracts issued during 1986 through December 31, 1992: Optional use of the 1985 NAIC Cancer Claim Cost Tables.

(b) Claim reserves: No specific standard. See subsection (5) of this section.

(4) Accidental death benefits.

(a) Contract reserves for contracts issued on or after January 1, 1967: The 1959 Accidental Death Benefits Table.

(b) Claim reserves: Actual amount incurred.

(5) Other individual contract benefits.

(a) Contract reserves: For all other individual contract benefits, morbidity assumptions are to be determined using tables established for reserve purposes by a qualified actuary and acceptable to the commissioner.

(b) Claim reserves: For all benefits other than disability, claim reserves are to be based on the insurer's experience, if such experience is considered credible, or upon other assumptions designed to place a sound value on the liabilities.

#### NEW SECTION

WAC 284-16-510 SPECIFIC MINIMUM MORBIDITY STANDARDS FOR GROUP DISABILITY CONTRACTS. (1) Disability income benefits due to accident or sickness.

(a) Contract reserves for:

(i) Contracts issued prior to January 1, 1993: The same basis, if any, as that employed by the insurer as of December 31, 1992;

(ii) Contracts issued on or after January 1, 1993: The 1987 Commissioners Group Disability Income Table (87CGDT).

(b) Claim reserves for:

(i) Claims incurred on or after January 1, 1993: The 1987 Commissioners Group Disability Income Table (87CGDT);

(ii) Claims incurred prior to January 1, 1993: Optional use of either the 1964 Table or the 1987 Table.

(2) Other group contract benefits.

(a) Contract reserves: For all other group contract benefits, morbidity assumptions are to be determined using tables established for reserve purposes by a qualified actuary and acceptable to the commissioner.

(b) Claim reserves: For all benefits other than disability, claim reserves are to be based on the insurer's experience, if such experience is considered credible, or upon other assumptions designed to place a sound value on the liabilities.

#### NEW SECTION

WAC 284-16-520 SPECIFIC STANDARDS FOR INTEREST.

(1) For contract reserves the maximum interest rate is the maximum rate permitted by law in the valuation of whole life insurance issued on the same date as the disability insurance contract.

(2) For claim reserves the maximum interest rate is the maximum rate permitted by law in the valuation of whole life insurance issued on the same date as the claim incurrual date.

#### NEW SECTION

WAC 284-16-530 SPECIFIC STANDARDS FOR MORTALITY. The mortality basis used shall be according to a table, but without

use of selection factors, permitted by law for the valuation of whole life insurance issued on the same date as the disability insurance contract.

#### NEW SECTION

##### WAC 284-16-540 RESERVES FOR WAIVER OF PREMIUM.

(1) Waiver of premium reserves involve several special considerations. First, many disability valuation tables are based on exposures that include contracts on premium waiver as in-force contracts. Hence, contract reserves based on these tables are not reserves on "active lives" but rather reserves on contracts "in force." This is true for the 1964 CDT and for both the 1985 CIDA and CIDB Tables.

(2) Accordingly, tabular reserves using any of these tables should value reserves on the following basis:

(a) Claim reserves should include reserves for premiums expected to be waived, valuing as a minimum the valuation net premium being waived.

(b) Premium reserves should include contracts on premium waiver as in-force contracts, valuing as a minimum the unearned modal valuation net premium being waived.

(c) Contract reserves should include recognition of the waiver of premium benefit in addition to other contract benefits provided for, valuing as a minimum the valuation net premium to be waived.

(3) If an insurer is, instead, valuing reserves on what is truly an active life table, or if a specific valuation table is not being used but the insurer's gross premiums are calculated on a basis that includes in the projected exposure only those contracts for which premiums are being paid, then it may not be necessary to provide specifically for waiver of premium reserves. Any insurer using such a true "active life" basis should carefully consider, however, whether or not additional liability should be recognized on account of premiums waived during periods of disability or during claim continuation.

#### REPEALER

The following section of the Washington Administrative Code is repealed:

WAC 284-16-060 DISABILITY INSURANCE—MINIMUM RESERVE STANDARDS.

**WSR 92-15-104**  
**PROPOSED RULES**  
**OFFICE OF**  
**INSURANCE COMMISSIONER**

[Filed July 20, 1992, 4:01 p.m.]

#### Original Notice.

**Title of Rule:** Annual statement instructions and rules relating to audits of annual financial reports of insurers by certified public accountants.

**Purpose:** To enhance the surveillance of insurers' financial condition and to conform Washington's standards to those of the National Association of Insurance Commissioners (NAIC) to assist the state in becoming fully accredited by the NAIC.

**Other Identifying Information:** Insurance Commissioner Matter No. R 92-10.

**Statutory Authority for Adoption:** RCW 48.02.060.

**Statute Being Implemented:** RCW 48.05.250, 48.05.400, and 48.03.010.

**Summary:** Requires annual statements and examinations of insurers to meet NAIC standards, including examination by independent certified public accountants.

**Reasons Supporting Proposal:** The rules will improve the surveillance of the financial condition of insurers doing business in Washington; will assist the insurance commissioner's office to be "accredited" by the NAIC so that Washington's examinations of domestic insurers will

be on equal footing with foreign insurers; and will promote uniformity of regulatory practice among the states.

**Name of Agency Personnel Responsible for Drafting:** Mary Cotter and Robert E. Johnson, Insurance Building, Olympia, Washington, (206) 586-5591; **Implementation and Enforcement:** John B. Woodall, Insurance Building, Olympia, Washington, (206) 753-7303.

**Name of Proponent:** Dick Marquardt, Insurance Commissioner, governmental.

Rule is not necessitated by federal law, federal or state court decision.

**Explanation of Rule, its Purpose, and Anticipated Effects:** Each insurer must have an annual audit by an independent certified public accountant (CPA), and file such report by June 1 for the preceding calendar year. The contents required in the financial report are specified. The qualifications of the CPA and scope of the examination and report are detailed. Adverse financial conditions and significant deficiencies in internal controls of the insurer must be reported.

These rules follow model rules adopted by the National Association of Insurance Commissioners (NAIC), and are part of the rules and laws it requires a state to have in order to be accredited by the NAIC as having adequate insurer solvency standards. Their adoption will promote fiscal solvency of insurers transacting insurance in Washington and speed the day Washington is fully accredited by the NAIC.

Proposal does not change existing rules.

No small business economic impact statement is required for this proposal by chapter 19.85 RCW.

Most insurers will be required to employ the services of an independent certified public accountant to comply with the proposed rules. The cost of complying should not be a significant or additional financial burden, because most insurers should already be in compliance. RCW 48.05.250 requires that insurers utilize forms that conform to the requirements of the National Association of Insurance Commissioners (NAIC). The instructions for those forms already include the audit requirements. Further, if an insurer transacts business in other states, as most do, a number of other states also impose the CPA audit requirements so that insurers will be in compliance because of that. One reason for the adoption of these rules is that it will provide Washington state with standards the NAIC requires in order for the state to be "certified" as capable of ensuring the solvency of insurers. All states are moving toward "certification," so that insurers will be subjected to the same requirements, including those imposed by the proposed rules, regardless of their state of domicile. The cost of compliance per employee or per hour of labor for small or large businesses should be zero. Whatever cost there is results from the employment of outside accountants. The rules, in accord with the NAIC model, exempt insurers, having direct premiums written in this state of less than one million dollars in a calendar year and less than one thousand policyholders or certificateholders of directly written policies nationwide at the end of such calendar year, from the requirements for such year, unless the commissioner finds that compliance is necessary to carry out statutory duties. While not geared to the number of

employees, presumably a "small business" insurer would more likely fall within the exemption. Further, proposed WAC 284-07-220 permits any insurer to apply to the commissioner for an exemption from compliance with the rules, which may be granted if the commissioner finds that compliance would constitute a financial or organizational hardship upon the insurer. Relief for the "small business" insurer is, therefore, available under the proposed rules to minimize the economic impact of the rules.

Hearing Location: John L. Cherberg Building, Hearing Room #1, State Capitol Campus, 14th and Water Streets, Olympia, Washington, on August 27, 1992, at 10:30 a.m.

Submit Written Comments to: Insurance Commissioner, Insurance Building, P.O. Box 40255, Olympia, WA 98504-0255, by August 27, 1992.

Date of Intended Adoption: September 3, 1992.

July 20, 1992

Dick Marquardt

Insurance Commissioner

by Robert E. Johnson

Deputy Insurance Commissioner

#### NEW SECTION

WAC 284-07-050 ANNUAL STATEMENT INSTRUCTIONS. (1) Each authorized insurer is required by RCW 48.05.250 to file with the commissioner an annual statement in general form and context as approved by the National Association of Insurance Commissioners (NAIC) for the kinds of insurance to be reported upon, and pursuant to RCW 48.05.400 must also file a copy thereof with the NAIC. To effectuate those statutes and to enhance consistency in the accounting treatment accorded various kinds of insurance transactions, the valuation of assets, and related matters, insurers shall adhere to the appropriate Annual Statement Instructions and the Accounting Practices and Procedures Manuals promulgated by the NAIC.

(2) This section does not relieve an insurer from its obligation to comply with specific requirements of the insurance code or rules thereunder.

#### NEW SECTION

WAC 284-07-100 PURPOSE AND SCOPE. (1) The purpose of this regulation, WAC 284-07-100 through 284-07-230, is to improve the Washington state insurance commissioner's surveillance of the financial condition of insurers by requiring an annual examination by independent certified public accountants of the financial statements reporting the financial position and the results of operations of insurers.

(2) Every insurer, as defined in WAC 284-07-110, shall be subject to this regulation. Insurers having direct premiums written in this state of less than one million dollars in any calendar year and less than one thousand policyholders or certificateholders of directly written policies nation-wide at the end of such calendar year shall be exempt from this rule for such year (unless the commissioner makes a specific finding that compliance is necessary for the commissioner to carry out statutory responsibilities) except that insurers having assumed premiums pursuant to contracts and/or treaties of reinsurance of one million dollars or more will not be so exempt.

(3) Foreign or alien insurers filing audited financial reports in another state, pursuant to such other state's requirement of audited financial reports which has been found by the commissioner to be substantially similar to the requirements herein, are exempt from this rule if:

(a) A copy of the Audited Financial Report, Report on Significant Deficiencies in Internal Controls, and the Accountant's Letter of Qualifications which are filed with such other state are filed with the commissioner in accordance with the filing dates specified in WAC 284-07-120, 284-07-190 and 284-07-200, respectively; and

(b) A copy of any Notification of Adverse Financial Condition Report filed with such other state is filed with the commissioner within the time specified in WAC 284-07-180.

Canadian insurers may submit accountants' reports as filed with the Canadian Dominion Department of Insurance.

(4) This rule shall not prohibit, preclude, or in any way limit the commissioner from ordering, conducting, or performing examinations of insurers under the rules, regulations, practices, and procedures of the insurance commissioner.

#### NEW SECTION

WAC 284-07-110 DEFINITIONS. For the purposes of this regulation the following definitions shall apply:

(1) "Audited financial report" means and includes those items specified in WAC 284-07-130.

(2) "Accountant" and "independent certified public accountant" mean an independent certified public accountant or accounting firm in good standing with the American Institute of Certified Public Accountants and in all states in which they are licensed to practice; for Canadian and British companies, the terms mean a "Canadian-chartered or British-chartered accountant."

(3) "Insurer" means an insurer with a certificate of authority to transact the business of insurance in the state of Washington.

(4) "NAIC" means National Association of Insurance Commissioners.

#### NEW SECTION

WAC 284-07-120 FILING AND EXTENSIONS FOR FILING OF ANNUAL AUDITED FINANCIAL REPORTS. (1) All insurers shall have an annual audit by an independent certified public accountant and shall file an audited financial report with the commissioner on or before June 1 for the year ended December 31 immediately preceding. The commissioner may require an insurer to file an audited financial report earlier than June 1 with ninety days advance notice to the insurer.

(2) Extensions of the June 1 filing date may be granted by the commissioner for thirty-day periods upon showing by the insurer and its independent certified public accountant the reasons for requesting such extension and determination by the commissioner of good cause for an extension. The request for extension must be submitted in writing not less than ten days prior to the due date in sufficient detail to permit the commissioner to make an informed decision with respect to the requested extension.

#### NEW SECTION

WAC 284-07-130 CONTENTS OF ANNUAL AUDITED FINANCIAL REPORT. (1) The annual audited financial report shall report the financial position of the insurer as of the end of the most recent calendar year and the results of its operations, cash flows, and changes in capital and surplus for the year then ended in conformity with statutory accounting practices prescribed, or otherwise permitted, by the commissioner.

(2) The annual audited financial report shall include the following:

(a) Report of independent certified public accountant.

(b) Balance sheet reporting admitted assets, liabilities, capital, and surplus.

(c) Statement of operations.

(d) Statement of cash flows.

(e) Statement of changes in capital and surplus.

(f) Notes to financial statements. These notes shall be those required by the appropriate NAIC Annual Statement Instructions and any other notes required by generally accepted accounting principles and shall also include:

(i) A reconciliation of differences, if any, between the audited statutory financial statements and the annual statement filed pursuant to RCW 48.05.250 with a written description of the nature of these differences.

(ii) A summary of ownership and relationships of the insurer and all affiliated companies.

(g) The financial statements included in the audited financial report shall be prepared in a form and using language and groupings substantially the same as the relevant sections of the annual statement of the insurer filed with the commissioner, and the financial statements shall be comparative, presenting the amounts as of December 31. However, in the first year in which an insurer is required to file an audited financial report, the comparative data may be omitted.

**NEW SECTION**

**WAC 284-07-140 DESIGNATION OF INDEPENDENT CERTIFIED PUBLIC ACCOUNTANT.** (1) Each insurer required by this regulation to file an annual audited financial report must, within sixty days after becoming subject to such requirement, register with the commissioner in writing the name and address of the independent certified public accountant or accounting firm retained to conduct the annual audit required by this regulation. Insurers not retaining an independent certified public accountant on the effective date of this rule shall register the name and address of their retained certified public accountant not less than six months before the date when the first audited financial report is to be filed.

(2) The insurer shall obtain a letter from the accountant, and file a copy with the commissioner stating that the accountant is aware of the provisions of the Washington state insurance code, Title 48, and the rules and regulations thereunder, that relate to accounting and financial matters and affirming that the accountant will express his or her opinion on the financial statements in terms of their conformity to the statutory accounting practices prescribed or otherwise permitted by the commissioner, specifying such exceptions as are believed appropriate.

(3) If an accountant who was the accountant for the immediately preceding filed audited financial report is dismissed or resigns, the insurer shall, within five business days, notify the commissioner of this event. The insurer shall also furnish the commissioner with a separate letter within ten business days of the above notification stating whether in the twenty-four months preceding such event there were any disagreements with the former accountant on any matter of accounting principles or practices, financial statement disclosure, or auditing scope or procedure, which disagreements, if not resolved to the satisfaction of the former accountant, would have caused him to make reference to the subject matter of the disagreement in connection with his opinion. The disagreements required to be reported in response to this section include both those resolved to the former accountant's satisfaction and those not resolved to the former accountant's satisfaction. Disagreements contemplated by this section are those that occur at the decision-making level, i.e., between personnel of the insurer responsible for presentation of its financial statements and personnel of the accounting firm responsible for rendering its report. The insurer shall also in writing request such former accountant to furnish a letter addressed to the insurer stating whether the accountant agrees with the statements contained in the insurer's letter and, if not, stating the reasons for disagreement; and the insurer shall furnish such responsive letter from the former accountant to the commissioner together with its own.

**NEW SECTION**

**WAC 284-07-150 QUALIFICATIONS OF INDEPENDENT CERTIFIED PUBLIC ACCOUNTANT.** (1) The commissioner shall not recognize any person or firm as a qualified independent certified public accountant that is not in good standing with the American Institute of Certified Public Accountants and in all states in which the accountant is licensed to practice, or, for a Canadian or British company, that is not a chartered accountant.

(2) Except as otherwise provided herein, an independent certified public accountant shall be recognized as qualified as long as he or she conforms to the standards of his or her profession, as contained in the Code of Professional Ethics of the American Institute of Certified Public Accountants and the code of professional conduct of the state of Washington board of public accountancy, or similar applicable code.

(3) No partner or other person responsible for rendering a report may act in that capacity for more than seven consecutive years. Following any period of service such person shall be disqualified from acting in that or a similar capacity for the same company or its insurance subsidiaries or affiliates for a period of two years. An insurer may make application to the commissioner for relief from the above rotation requirement on the basis of unusual circumstances. The commissioner may consider the following factors in determining if the relief should be granted:

- (a) Number of partners, expertise of the partners, or the number of insurance clients in the currently registered firm;
- (b) Premium volume of the insurer; and
- (c) Number of jurisdictions in which the insurer transacts business.

The requirements of this subsection shall become effective two years after the enactment of this regulation.

(4) The commissioner shall not recognize as a qualified independent certified public accountant, nor accept any annual audited financial report, prepared in whole or in part by, any natural person who:

(a) Has been convicted of fraud, bribery, a violation of the Racketeer Influenced and Corrupt Organizations Act, 18 U.S.C. Sections 1961-1968, or any dishonest conduct or practices under federal or state law;

(b) Has been found to have violated the insurance laws of this state with respect to any previous reports submitted under this rule; or

(c) Has demonstrated a pattern or practice of failing to detect or disclose material information in previous reports filed under the provisions of this rule.

(5) The commissioner as provided in RCW 48.02.060 may hold a hearing to determine whether a certified public accountant is qualified and, considering the evidence presented, may rule that the accountant is not qualified for purposes of expressing his or her opinion on the financial statements in the annual audited financial report made pursuant to this regulation and require the insurer to replace the accountant with another whose relationship with the insurer is qualified within the meaning of this regulation.

**NEW SECTION**

**WAC 284-07-160 CONSOLIDATED OR COMBINED AUDITS.** An insurer may make written application to the commissioner for approval to file audited consolidated or combined financial statements in lieu of separate annual audited financial statements if the insurer is part of a group of insurance companies which utilizes a pooling or one hundred percent reinsurance agreement that affects the solvency and integrity of the insurer's reserves and such insurer cedes all of its direct and assumed business to the pool. In such cases, a columnar consolidating or combining worksheet shall be filed with the report, as follows:

(1) Amounts shown on the consolidated or combined audited financial report shall be shown on the worksheet.

(2) Amounts for each insurer subject to this section shall be stated separately.

(3) Noninsurance operations may be shown on the worksheet on a combined or individual basis.

(4) Explanations of consolidating and eliminating entries shall be included.

(5) A reconciliation shall be included of any differences between the amounts shown in the individual insurer columns of the worksheet and comparable amounts shown on the annual statements of the insurers.

**NEW SECTION**

**WAC 284-07-170 SCOPE OF EXAMINATION AND REPORT OF INDEPENDENT CERTIFIED PUBLIC ACCOUNTANT.** Financial statements furnished pursuant to WAC 284-07-130 hereof shall be examined by an independent certified public accountant. The examination of the insurer's financial statements shall be conducted in accordance with generally accepted auditing standards. Consideration should also be given to such other procedures illustrated in the Financial Condition Examiner's Handbook promulgated by the National Association of Insurance Commissioners as the independent certified public accountant deems necessary.

**NEW SECTION**

**WAC 284-07-180 NOTIFICATION OF ADVERSE FINANCIAL CONDITION.** (1) The insurer required to furnish the annual audited financial report shall require the independent certified public accountant to report, in writing, within five business days to the board of directors or its audit committee any determination by the independent certified public accountant that the insurer has materially misstated its financial condition as reported to the commissioner as of the balance sheet date currently under examination or that the insurer does not meet the minimum capital and surplus requirements of the Washington state insurance code as of that date. An insurer who has received a report pursuant to this subsection shall forward a copy of the report to the commissioner within five business days of receipt of such report and shall provide the independent certified public accountant making the report with evidence of the report being furnished to the commissioner. If the independent certified public accountant fails to receive such evidence within the required five business day period, the independent certified public accountant shall furnish to the commissioner a copy of its report within the next five business days.

(2) No independent public accountant shall, by virtue of this regulation, be liable in any manner to any person for any statement made

in connection with subsection (1) of this section if such statement is made in good faith in compliance with subsection (1) of this section.

(3) If the accountant, subsequent to the date of the audited financial report filed pursuant to this regulation, becomes aware of facts which might have affected his or her report, the accountant should take such action as is prescribed in Volume 1, Section AU 561 of the Professional Standards of the American Institute of Certified Public Accountants.

#### NEW SECTION

**WAC 284-07-190 REPORT ON SIGNIFICANT DEFICIENCIES IN INTERNAL CONTROLS.** In addition to the annual audited financial statements, each insurer shall furnish the commissioner with a written report prepared by the accountant describing significant deficiencies in the insurer's internal control structure noted by the accountant during the audit. SAS No. 60, Communication of Internal Control Structure Matters Noted in an Audit (AU Section 325 of the Professional Standards of the American Institute of Certified Public Accountants) requires an accountant to communicate significant deficiencies (known as "reportable conditions") noted during a financial statement audit to the appropriate parties within an entity. No report should be issued if the accountant does not identify significant deficiencies. If significant deficiencies are noted, the written report shall be filed annually by the insurer with the commissioner within sixty days after the filing of the annual audited financial statements. The insurer is required to provide a description of remedial actions taken or proposed to correct significant deficiencies, if such actions are not described in the accountant's report.

#### NEW SECTION

**WAC 284-07-200 ACCOUNTANT'S LETTER OF QUALIFICATIONS.** The accountant shall furnish the insurer in connection with, and for inclusion in, the filing of the annual audited financial report, a letter stating:

(1) That the accountant is independent with respect to the insurer and conforms to the standards of his or her profession as contained in the Code of Professional Ethics and pronouncements of the American Institute of Certified Public Accountants and the rules of professional conduct of the Washington board of public accountancy, or similar applicable rules.

(2) The background and experience in general, and the experience in audits of insurers of the staff assigned to the engagement and whether each is an independent certified public accountant. Nothing within this rule shall be construed as prohibiting the accountant from utilizing such staff as he or she deems appropriate where use is consistent with the standards prescribed by generally accepted auditing standards.

(3) That the accountant understands the annual audited financial report and the opinion thereon will be filed in compliance with this rule and that the commissioner will be relying on this information in the monitoring and regulation of the financial position of insurers.

(4) That the accountant consents to the requirements of WAC 284-07-210 and that the accountant consents and agrees to make available for review by the commissioner or his designee the workpapers, as defined in WAC 284-07-210.

(5) A representation that the accountant is properly licensed by an appropriate state licensing authority and is a member in good standing in the American Institute of Certified Public Accountants.

(6) A representation that the accountant is in compliance with the requirements of WAC 284-07-150.

#### NEW SECTION

**WAC 284-07-210 DEFINITION, AVAILABILITY, AND MAINTENANCE OF CPA WORKPAPERS.** (1) Workpapers are the records kept by the independent certified public accountant of the procedures followed, the tests performed, the information obtained, and the conclusions reached pertinent to the examination of the financial statements of an insurer. Workpapers, accordingly, may include audit planning documentation, work programs, analyses, memoranda, letters of confirmation and representation, abstracts of company documents and schedules or commentaries prepared or obtained by the independent certified public accountant in the course of the examination of the financial statements of an insurer and which support the accountant's opinion thereof.

(2) Every insurer required to file an audited financial report pursuant to this regulation, shall require the accountant to make available

for review by the commissioner's examiners, all workpapers prepared in the conduct of the examination and any communications related to the audit between the accountant and the insurer, at the offices of the insurer, at the commissioner's office or at any other reasonable place designated by the commissioner. The insurer shall require that the accountant retain the audit workpapers and communications until the commissioner has filed a report on examination covering the period of the audit but no longer than seven years from the date of the audit report.

(3) In the conduct of the aforementioned periodic review by the commissioner's examiners, it shall be agreed that photocopies of pertinent audit workpapers may be made and retained by the commissioner's office. Such reviews by the commissioner's examiners shall be considered investigations and all working papers and communications obtained during the course of such investigations shall be afforded the same confidentiality as other examination workpapers generated by the insurance commissioner.

#### NEW SECTION

**WAC 284-07-220 EXEMPTIONS AND EFFECTIVE DATES.**

(1) Upon written application of any insurer, the commissioner may grant an exemption from compliance with this regulation if the commissioner finds, upon review of the application, that compliance would constitute a financial or organizational hardship upon the insurer. An exemption may be granted at any time and from time to time for a specified period or periods. Within ten days from a denial of an insurer's written request for an exemption from this regulation, such insurer may request in writing a hearing on its application for an exemption. Such hearing shall be held in accordance with the rules and procedures pertaining to administrative hearings.

(2) Domestic insurers retaining a certified public accountant on the effective date of this regulation who qualify as independent shall comply with this regulation for the year ending December 31, 1992, and each year thereafter unless the commissioner permits otherwise.

(3) Domestic insurers not retaining a certified public accountant on the effective date of this regulation who qualify as independent may meet the following schedule for compliance unless the commissioner permits otherwise.

(a) As of December 31, 1992, file with the commissioner:

- (i) Report of independent certified public accountant;
- (ii) Audited balance sheet;
- (iii) Notes to audited balance sheet.

(b) For the year ending December 31, 1992, and each year thereafter, such insurers shall file with the commissioner all reports required by this regulation.

(4) Foreign insurers shall comply with this regulation for the year ending December 31, 1992, and each year thereafter, unless the commissioner permits otherwise.

#### NEW SECTION

**WAC 284-07-230 CANADIAN AND BRITISH COMPANIES.** (1) In the case of Canadian and British insurers, the annual audited financial report shall be defined as the annual statement of total business on the form filed by such companies with their domiciliary supervision authority duly audited by an independent chartered accountant.

(2) For such insurers, the letter required in WAC 284-07-140(2) shall state that the accountant is aware of the requirements relating to the annual audited statement filed with the commissioner pursuant to WAC 284-07-120 and shall affirm that the opinion expressed is in conformity with such requirements.

### **WSR 92-15-105**

#### **PERMANENT RULES**

#### **DEPARTMENT OF FISHERIES**

[Order 92-47—Filed July 20, 1992, 5:00 p.m.]

Date of Adoption: June 30, 1992.

Purpose: Amend commercial fishing rules.

Citation of Existing Rules Affected by this Order:  
Amending WAC 220-16-040, 220-47-302, 220-47-



304, 220-47-307, 220-47-311, 220-47-319, 220-47-401, 220-47-411, 220-47-412, and 220-47-500.

Statutory Authority for Adoption: RCW 75.08.080.

Pursuant to notice filed as WSR 92-09-137 on April 22, 1992; and WSR 92-11-083 on May 20, 1992.

Changes Other than Editing from Proposed to Adopted Version: WAC 220-47-301, withdrawn; WAC 220-47-302, net depth restrictions withdrawn; clarification provided that skiff gill nets are lawful gear in all drift gill net fisheries; WAC 220-47-307, make north area 10 closure effective during coho management only; withdraw shoreline closure in Hood Canal; WAC 220-47-319, do not require 5-inch strip during Fraser Panel sockeye and pink salmon management; WAC 220-47-411, make Area 6D a skiff fishery only and adjust dates; and WAC 220-47-500, clarify reasons for limited participation fishery.

Effective Date of Rule: Thirty-one days after filing.

July 17, 1992  
 Judith Merchant  
 Deputy Director  
 for Robert Turner  
 Acting Director

AMENDATORY SECTION (Amending Order 88-86, filed 9/2/88)

WAC 220-16-040 DEFINITIONS—DRIFT GILL NET—DRIFT NET. "Drift gill net" or "drift net" gear shall be defined as a gill net of single web construction, not anchored, tied, staked, placed, or weighted in such a manner that it cannot drift.

NEW SECTION

WAC 220-16-046 DEFINITIONS—SKIFF GILL NET—SKIFF NET. "Skiff gill net" or "skiff net" is defined as a gill net of single web construction with floats along the corkline sufficient to float the net. A skiff gill net may be laid in part on shore, but may not be anchored, tied, or staked, nor have a lead line so heavily weighted that the net cannot drift.

AMENDATORY SECTION (Amending Order 988, filed 4/28/72)

WAC 220-47-302 PUGET SOUND—LAWFUL GEAR—GILL NET. (1) Lawful drift gill net salmon ((nets)) gear in Puget Sound shall not exceed 1,800 feet in length nor contain meshes of a size less than 5 inches. ((The nets))

(2) Lawful skiff gill net salmon nets in Puget Sound shall not exceed 300 feet in length and 90 meshes in depth nor contain meshes of a size less than 5 inches. Nets must be retrieved by hand (no hydraulics may be used). The skiff from which the net is deployed shall not exceed 20 feet in length. Nets must be attended by the fisher at all times. Skiff gill net gear is legal gear in any fishery opened to drift gill net gear.

(3) Drift gill nets and skiff gill nets shall be operated substantially in a straight line. Circle setting ((with a gill net)) or setting ((a gill net)) other than substantially in a straight line shall be unlawful.

(4) Effective January 1, 1993, all gill net gear used in Puget Sound must have floats or corks of a contrasting fluorescent color attached in 50-foot intervals along the corkline.

AMENDATORY SECTION (Amending Order 91-72, filed 8/27/91, effective 9/27/91)

WAC 220-47-304 PUGET SOUND—ALL CITIZEN SALMON SPECIES SEASONS. The following are Puget Sound all citizens salmon species seasons listed by area and species:

AREA	SPECIES	DATE	RANGE
6D:	COHO	9/22	10/26
7,7A:	COHO	9/1	10/12
	CHUM	10/13	11/30
7B:	CHINOOK	7/28	9/7
	COHO	9/8	10/26
	CHUM	10/27	11/30
7C:	CHINOOK	7/28	8/24
7E:	CHINOOK	7/28	9/7
8:	PINK	8/18	9/14
	CHUM	10/27	11/23
8A:	CHINOOK	7/28	9/7
	COHO	9/8	10/19
	CHUM	10/20	11/30
8D:	CHINOOK	7/28	9/21
	COHO	9/22	11/9
	CHUM	11/10	11/30
10,11:	PINK	8/25	9/7
	COHO	9/8	10/19
	CHUM	10/20	11/30
12:	COHO	9/8	10/19
	CHUM	10/20	11/16
12A:	COHO	9/8	10/19
	CHUM	10/20	11/16
12B:	CHINOOK	7/28	9/7
	COHO	9/8	10/19
	CHUM	10/20	11/16
12C:	CHINOOK	7/28	9/7
	CHUM	10/27	11/30

AREA	SPECIES	DATE - RANGE
6D:	COHO	9/20 - 10/31
7,7A:	COHO	8/30 - 10/3
	CHUM	10/4 - 11/28
7B:	CHINOOK	7/12 - 9/5
	COHO	9/6 - 10/24
	CHUM	10/25 - 12/12
7C:	CHINOOK	7/12 - 10/10
7E:	CHINOOK	7/26 - 9/5
8:	CHUM	10/25 - 11/28
8A:	CHINOOK	7/19 - 9/5
	COHO	9/6 - 10/24
	CHUM	10/25 - 11/28
8D:	CHINOOK	7/19 - 9/19
	COHO	9/20 - 11/7
	CHUM	11/8 - 12/12
10,11:	COHO	9/6 - 10/17
	CHUM	10/18 - 11/28



AREA	SPECIES	DATE - RANGE
12:	COHO	9/6 - 10/17
	CHUM	10/18 - 11/21
12B:	CHINOOK	7/12 - 9/5
	COHO	9/6 - 10/17
	CHUM	10/18 - 11/21
12C:	CHINOOK	7/19 - 9/5
	CHUM	11/1 - 11/28

**AMENDATORY SECTION** (Amending Order 91-72, filed 8/27/91, effective 9/27/91)

**WAC 220-47-307 CLOSED AREAS—PUGET SOUND SALMON.** It is unlawful at any time, unless otherwise provided, to take, fish for, or possess salmon taken for commercial purposes with any type of gear from the following portions of Puget Sound Salmon Management and Catch Reporting Areas:

Areas 4B, 5, 6, 6B, and 6C - The Strait of Juan de Fuca Preserve as defined in WAC 220-47-266.

Area 6D - That portion within 1,000 feet of each mouth of the Dungeness River.

Area 7 - The San Juan Island Preserve as defined in WAC 220-47-262.

Area 7A - The Drayton Harbor Preserve as defined in WAC 220-47-252.

Area 7B - That portion south and east of a line from William Point on Samish Island to Saddlebag Island to the southeastern tip of Guemes Island, and that portion northerly of the railroad trestle in Chuckanut Bay.

Area 7C - That portion southeasterly of a line projected from the mouth of Oyster Creek 237° true to a fishing boundary marker on Samish Island.

Area 8 - That portion of Skagit Bay easterly of a line projected from Brown Point on Camano Island to a white monument on the easterly point of Ika Island, thence across the Skagit River to the terminus of the jetty with McGlenn Island.

Area 8A - Those waters easterly of a line projected from Mission Point to Buoy C1, excluding the waters of Area 8D, thence through the green light at the entrance jetty of the Snohomish River and across the mouth of the Snohomish River to landfall on the eastern shore, and those waters northerly of a line from Camano Head to the northern boundary of Area 8D.

Area 9 - Those waters lying inside and westerly of a line projected from the Point No Point light to Sierra Echo buoy thence to Forbes Landing wharf, east of Hansville.

Area 10 - ~~((That portion))~~ (1) Those waters easterly of a line projected from Meadow Point to West Point ~~((and that portion))~~.

(2) Those waters of Port Madison northwest of a line from the Agate Pass entrance light to the light on the end of the Indianola dock.

(3) Additional coho seasonal closure: Those waters of Elliott Bay east of a line from Alki Point to the light at Fourmile Rock and those waters northerly of a line projected from Point Wells to "SF" Buoy then west to President's Point.

Area 10E - Those waters of Liberty Bay north of a line projected due east from the southernmost Keyport

dock, those waters of Dyes Inlet north of the Manette Bridge, and those waters of Sinclair Inlet southwest of a line projected true east from the Bremerton ferry terminal.

Area 11 - Those waters northerly of a line projected true west from the light at the mouth of Gig Harbor and those waters south of a line from Browns Point to the northernmost point of land on Point Defiance.

Area 12 - Those waters inside and easterly of a line projected from Lone Rock to the navigation light off Big Beef Creek, thence southerly to the tip of the outermost northern headland of Little Beef Creek.

Area 12A - Those waters north of a line projected from Fisherman's Point on the Bolton Peninsula to the boat haven at Quilcene and those waters north of a line projected due east from Broad Spit.

Area 12B - Those waters within 1/4 mile of the mouths of the Dosewallips, Duckabush, and Hamma Hamma rivers and Anderson Creek.

Areas 12, 12A, and 12B - Additional chinook seasonal closure: Those waters north and east of a line projected from Tekiu Point to Triton Head.

Area 12C - (1) Those waters within 1,000 feet of the western shore between the dock at Glen Ayr R.V. Park and the Hoodsport marina dock ~~((and))~~.

(2) Those waters south of a line projected from the Cushman Powerhouse to the public boat ramp at Union.

(3) Those waters within 1/4 mile of the mouth of the Dewatto River.

Areas 12, 12B, 12C, and 12D - Additional coho and chum seasonal closure: Those waters of Area 12 south and west of a line projected 94 degrees true from Hazel Point to the light on the opposite shore, bounded on the west by the Area 12/12B boundary line, and those waters of Areas 12B, 12C, and 12D south of a line projected from Tekiu Point to Triton Head.

Area 13A - Those waters of Burley Lagoon north of State Route 302, those waters within 1,000 feet of the outer oyster stakes off Minter Creek Bay including all waters of Minter Creek Bay, those waters westerly of a line drawn due north from Thompson Spit at the mouth of Glen Cove, and those waters within 1/4 mile of Green Point.

**AMENDATORY SECTION** (Amending Order 91-72, filed 8/27/91, effective 9/27/91)

**WAC 220-47-311 PURSE SEINE—OPEN PERIODS.** During ~~((1991))~~ 1992, it is unlawful to take, fish for or possess salmon taken with purse seine gear for commercial purposes from Puget Sound except in the following designated Puget Sound Salmon Management and Catch Reporting Areas during the periods provided for hereinafter in each respective Management and Catch Reporting Area:

AREA	TIME	DATE
6D:	5AM - 4PM	9/22 - 10/25
7,7A:	5AM - 8PM	10/28
	5AM - 8PM	10/29
	5AM - 8PM	11/5
	5AM - 8PM	11/6
	5AM - 8PM	11/11

AREA	TIME	DATE	TIME	DATE
7B:	5AM	9/9	4PM	10/25
	5AM	10/28	4PM	11/1
	5AM	11/4	4PM	11/8
8:	5AM	-	9PM	8/27
	5AM	-	9PM	8/28
	5AM	-	9PM	8/29
	5AM	-	9PM	9/3
	5AM	-	9PM	9/4
	5AM	-	9PM	9/5
9A:	5AM	9/16	4PM	9/20
	5AM	9/23	4PM	9/27
	5AM	9/30	4PM	10/4
	5AM	10/7	4PM	10/11
	5AM	10/14	4PM	10/18
	5AM	10/21	4PM	10/25
	5AM	10/28	4PM	11/1
10,11:	5AM	-	9PM	9/16
	5AM	-	9PM	9/24
	5AM	-	9PM	10/22
	5AM	-	8PM	10/28
12,12B:	5AM	-	8PM	11/5
	5AM	-	8PM	11/6
	5AM	-	8PM	11/11
12A:	5AM	9/3	4PM	9/6
	5AM	9/9	4PM	9/13
	5AM	9/16	4PM	9/20
	5AM	9/23	4PM	9/27
	5AM	9/30	4PM	10/4
	5AM	10/7	4PM	10/11
AREA	TIME	DATE	TIME	DATE

6D:	6AM	9/21	4PM	10/30
7,7A:	6AM	-	5PM	10/27, 11/2, 11/10
7B:	6AM	9/14	4PM	10/23
	6AM	10/26	4PM	11/6
8:	6AM	-	5PM	11/2, 11/3, 11/10
	7AM	-	5PM	11/16, 11/17
8A:	6AM	-	5PM	11/2, 11/3, 11/4
	6AM	-	5PM	11/10, 11/11, 11/12
	7AM	-	5PM	11/16, 11/17
	7AM	-	5PM	11/24, 11/25
8D:	6AM	-	8PM	9/21, 9/22, 9/23, 9/24
	6AM	-	8PM	9/29, 9/30, 10/1, 10/2
	7AM	-	7PM	10/5, 10/6, 10/7, 10/8
	7AM	-	7PM	10/13, 10/14, 10/15, 10/16
	7AM	-	7PM	10/19, 10/20, 10/21, 10/22
	6AM	-	5PM	10/27, 10/28, 10/29, 10/30
	6AM	-	5PM	11/2, 11/3, 11/4, 11/5

AREA	TIME	DATE	TIME	DATE
10,11:	6AM	-	8PM	9/21, 9/29, 9/30
	7AM	-	7PM	10/5, 10/6, 10/19
	6AM	-	5PM	10/27, 11/2, 11/10
12,12B:	6AM	-	5PM	11/2, 11/3, 11/10, 11/11
	7AM	-	5PM	11/16

All other saltwater and freshwater areas - closed.

**AMENDATORY SECTION** (Amending Order 91-72, filed 8/27/91, effective 9/27/91)

WAC 220-47-319 SPECIAL PURSE SEINE MESH SIZE. It shall be unlawful to take, fish for or possess salmon taken with purse seine gear in any Puget Sound Salmon Management and Catch Reporting Area((s 6B, 6D, 8, 8A, 8D, 9, 9A, 10, 10A, 10C, 10D, 10E, 10F, 10G, 11, 11A, 12, 12A, 12B, 12C, 12D, 13, 13A, 13C, 13D, 13E, 13F, 13G, 13H, 13I, 13J and 13K)) exclusive of Fraser Panel sockeye and pink salmon management unless said purse seine gear is constructed so that the first 100 meshes below the corkline that are within 75 fathoms of the bunt, excluding the bunt, are of a size not less than 5 inches stretch measure.

**AMENDATORY SECTION** (Amending Order 91-72, filed 8/27/91, effective 9/27/91)

WAC 220-47-401 REEF NET OPEN PERIODS. During ((+99+)) 1992, it is unlawful to take, fish for or possess salmon taken with reef net gear for commercial purposes in Puget Sound ((except in the following designated Puget Sound Salmon Management and Catch Reporting Areas, during the periods provided for hereinafter in each respective area:

AREA	TIME	DATE
7:	5AM - 9PM	10/6
	5AM - 9PM	10/7
7,7A:	5AM - 9PM	10/15
	5AM - 9PM	10/16
	5AM - 9PM	10/17

All other saltwater and freshwater areas = closed)).

**AMENDATORY SECTION** (Amending Order 91-72, filed 8/27/91, effective 9/27/91)

WAC 220-47-411 GILL NET-OPEN PERIODS. During ((+99+)) 1992, it is unlawful to take, fish for or possess salmon taken with gill net gear for commercial purposes from Puget Sound except in the following designated Puget Sound Salmon Management and Catch Reporting Areas during the seasons provided for hereinafter in each respective fishing area:

AREA	TIME	DATE(S)
6D:	5AM - 9PM	10/22
7,7A:	5PM - 9AM	NIGHTLY 10/28, 10/29
	4PM - 8AM	NIGHTLY 11/4, 11/5, 11/11

AREA	TIME	DATE(S)
7B:	7PM - 9:30AM	NIGHTLY 7/29, 7/30
	7PM - 9:30AM	NIGHTLY 8/5, 8/6, 8/7
	6PM - 9AM	NIGHTLY 8/12, 8/13, 8/14
	6PM - 9AM	NIGHTLY 8/19, 8/20
	6PM 9/8	4PM 10/25
	5AM 10/28	4PM 11/1
	5AM 11/4	4PM 11/8
7C:	7PM - 9:30AM	NIGHTLY 7/29, 7/30
	7PM - 9:30AM	NIGHTLY 8/5, 8/6, 8/7
	6PM - 9AM	NIGHTLY 8/12, 8/13, 8/14
	6PM - 9AM	NIGHTLY 8/19, 8/20
8:	6PM - 9AM	NIGHTLY 8/20, 8/21, 8/26, 8/27, 8/28, 9/3, 9/4, 9/5, and 9/9
9A:	5AM 9/16	4PM 9/20
	5AM 9/23	4PM 9/27
	5AM 9/30	4PM 10/4
	5AM 10/7	4PM 10/11
	5AM 10/14	4PM 10/18
	5AM 10/21	4PM 10/25
	5AM 10/28	4PM 11/1
10,11:	5PM - 9AM	NIGHTLY 9/16, 9/23, 10/21
	4PM - 8AM	NIGHTLY 10/28
12,12B:	4PM - 8AM	11/4, 11/5, 11/11
12A:	5AM 9/3	4PM 9/6
12A:	5AM 9/9	4PM 9/13
12A:	5AM 9/16	4PM 9/20
12A:	5AM 9/23	4PM 9/27
12A:	5AM 9/30	4PM 10/4
12A:	5AM 10/7	4PM 10/11
AREA TIME		DATE(S)
6D:	6AM 9/20 -	4PM 10/23
Skiff fishery only.		
7,7A:	4PM - 7AM	NIGHTLY 10/26, 11/2, 11/9
7B:	8PM - 6AM	NIGHTLY 7/27, 7/28, 8/3, 8/4, 8/5, 8/10, 8/11, 8/12
	7PM - 7AM	NIGHTLY 8/17, 8/18
	7PM 9/8	4PM 10/23
	4PM 10/26	4PM 11/6
8:	4PM - 7AM	NIGHTLY 11/2, 11/3
	4PM - 8AM	NIGHTLY 11/9, 11/16, 11/17
8A:	4PM - 7AM	NIGHTLY 11/2, 11/3, 11/4
	4PM - 8AM	NIGHTLY 11/9, 11/10, 11/11, 11/16, 11/17, 11/23, 11/24
8D:	6PM - 8AM	NIGHTLY 9/21, 9/22, 9/23, 9/24, 9/28, 9/29, 9/30, 10/1, 10/5, 10/6, 10/7, 10/8, 10/12, 10/13, 10/14, 10/15, 10/19, 10/20, 10/21, 10/22
	4PM - 7AM	NIGHTLY 10/26, 10/27, 10/28, 10/29, 11/2, 11/3, 11/4, 11/5
10,11:	6PM - 8AM	NIGHTLY 9/21, 9/25, 9/29, 10/5, 10/6, 10/19
	4PM - 7AM	NIGHTLY 10/26, 11/2
	4PM - 8AM	NIGHTLY 11/9
12,12B:	4PM - 7AM	NIGHTLY 11/2, 11/3
	4PM - 8AM	NIGHTLY 11/9, 11/10, 11/16

All other saltwater and freshwater areas - closed.  
Nightly openings refer to the start date.

AMENDATORY SECTION (Amending Order 90-49, filed 6/11/90, effective 7/12/90)

WAC 220-47-412 DRIFT GILL NET AND SKIFF GILL NET—MINIMUM MESH SIZES. It is unlawful to take, fish for or possess salmon taken with ((gill)) net gear using mesh less than the size hereinafter designated for each species season:

CHINOOK SEASON	7" MINIMUM MESH
COHO SEASON	5" MINIMUM MESH
PINK SEASON	5" MINIMUM MESH
CHUM SEASON	6" MINIMUM MESH

AMENDATORY SECTION (Amending Order 90-49, filed 6/11/90, effective 7/12/90)

WAC 220-47-500 LIMITED PARTICIPATION SALMON NET FISHERIES. (1) When the director determines that a harvestable amount of salmon appears to be available, but that full-fleet fishing effort has an unacceptable risk of exceeding the available harvest or compromises other specific management objectives, the director may authorize a limited participation fishery in extreme terminal fishing areas in order to provide additional opportunities for net fisheries where they might not otherwise exist. Such a fishery may be authorized for experimental or developmental fisheries, fisheries necessary to refine run size data, fisheries necessary to provide biological information, or in cases where:

(a) Other specific management objectives have been stated for the species and area in question; or

(b) There is a reasonable expectation that foregone opportunity will be claimed and the harvestable surplus cannot be carried forward to the next year of harvest; and

((b)) (c) Full-fleet participation with time, space, or gear restrictions cannot achieve the harvest goal.

(2) Only licensed commercial salmon fishers may participate in a limited participation fishery. Only one listing is allowed per license. Fishers who wish to have their name placed on a limited participation register must mark the appropriate box on their license renewal application, or so notify the department, in writing, by July 31st. Interested fishers must provide a message phone number at which they may be contacted.

(3) Each year the department will, from the list of interested fishers, use random selection to create a priority list for gillnet fishers and a priority list for purse seine fishers. Priority registers will be available for inspection at the department's Olympia office, or upon written request to the department. Once the priority lists have been created, sale or transfer of the license shall invalidate the receiver from participation in that year's limited participation fishery.

(4) The number of units of each gear type selected to participate in a limited participation fishery will reflect the most recent ratio of gear types in the full-fleet fishery directed at the species in question, except when conservation concerns ((σ)), biological data collection needs, or specific management objectives dictate alternative ratios or use of a single gear type.

(5) When a limited participation fishery is authorized, the department will contact fishers from the priority

register at least twenty-four hours prior to the opening of the fishery. When a fisher cannot be contacted after reasonable effort, the department will select the next name, until the maximum number of allowable units of gear is reached. If not reached, the fisher's name will remain at the priority position, but the fisher may not participate in that limited participation fishery. Agreement to participate, or declining to participate, will remove the fisher from the priority position, and place the name at the bottom of the priority list.

(6) Examples of specific management objectives include but are not limited to:

(a) Reducing levels of incidental catch of wild salmon stocks;

(b) Reducing incidental catch of nontarget salmon species originating from regions other than the fishing area; or

(c) Specific recreational emphasis action.

### WSR 92-15-106

#### EMERGENCY RULES

#### DEPARTMENT OF FISHERIES

[Order 92-48—Filed July 20, 1992, 5:00 p.m.]

Date of Adoption: July 20, 1992.

Purpose: Personal use rules.

Citation of Existing Rules Affected by this Order:  
Repealing WAC 220-56-19000V.

Statutory Authority for Adoption: RCW 75.08.080.

Pursuant to RCW 34.05.350 the agency for good cause finds that immediate adoption, amendment, or repeal of a rule is necessary for the preservation of the public health, safety, or general welfare, and that observing the time requirements of notice and opportunity to comment upon adoption of a permanent rule would be contrary to the public interest.

Reasons for this Finding: The harvestable quota of coho salmon has been met in Catch Reporting Area 4.

Effective Date of Rule: Immediately.

July 20, 1992

Judith Merchant

Deputy

for Robert Turner

Director

### NEW SECTION

**WAC 220-56-19000X SALTWATER SEASONS AND BAG LIMITS – SALMON** Notwithstanding the provisions of WAC 220-56-180 and WAC 220-56-190, effective immediately until further notice it is unlawful to fish for salmon in Catch Record Card Areas 1, 2, 3, and 4, except as provided for in this section:

(1) Areas and times open to salmon angling are as follows:

(a) Catch Record Card Area 4 – July 6 through 11:59 P.M. July 22, 1992. Open waters are defined as follows: waters inside or shoreward of a line running from the mouth of the Sekiu River to a point 1/2 mile due north, then to a point 1/2 mile due north of Seal Rock, then to a point 1/2 mile due north of the northernmost point on

Waadah Island, then to a point 1/2 mile due north of Chibahdehl Rocks, then to the northernmost point on Tatoosh Island, then from the western most point on Tatoosh Island to a point 1/2 mile due west of Fuca Pillar, then to Strawberry Rock, then to Spike Rock, then to Bodeltch Islands, then to Cape Alava. Waters of Catch Record Card Area 4 outside or seaward of this described line are closed to salmon angling. Closed to salmon angling each Friday and Saturday.

(b) Catch Record Card Area 4 waters in the Strait of Juan de Fuca lying east of the Bonilla-Tatoosh Line

– Open beginning:

i. August 15 if either the overall chinook quota of 33,000, or the coho sub-quota of 13,100 have been attained before August 15; or

ii. the day following attainment of either the overall chinook quota of 33,000, or the coho sub-quota of 13,100, if either occurs after August 15

– Close when 12,000 coho have been caught.

(c) Catch Record Card Area 3 – July 13 through October 1, or until overall chinook quota of 33,000, or until Catch Record Card Area 3 coho sub-quota of 3,000 is reached; whichever of the three is earliest. Waters more than 6 miles offshore are closed. Closed to salmon angling each Friday and Saturday.

(d) Catch Record Card Area 2 – July 6 through October 1, or until overall chinook quota of 33,000, or until Catch Record Card Area 2 coho sub-quota of 54,400 is reached; whichever of the three is earliest. Waters more than 6 miles offshore are closed. Closed to salmon angling each Friday and Saturday.

(e) Catch Record Card Area 1, but excluding waters of Columbia River Mouth Conservation Zone 1 (as defined in WAC 220-56-195) – June 29 through September 13, or until overall chinook quota of 33,000 or Catch Record Card Area 1 coho sub-quota of 67,500 is reached; whichever of the three is earliest. Waters more than 3 miles offshore are closed. Closed to salmon angling each Friday and Saturday.

(f) Catch Record Card Area 1, but excluding waters of Columbia River Mouth Conservation Zone 1 (as defined in WAC 220-56-195) – September 14 through October 31, or until overall chinook quota of 33,000 or Catch Record Card Area 1 coho sub-quota of 3,000 is reached; whichever of the three is earliest. Closed to salmon angling each Friday and Saturday.

(2) Bag Limits and weekly limits are as follows:

(a) 2 salmon per day, except in Catch Record Card Area 3 the daily limit is one salmon.

(b) No more than 4 salmon in any seven consecutive day period, except:

i. There is no weekly limit in Catch Record Card Area 1 beginning September 14.

ii. There is no weekly limit in the fishery described in subsection 1(b) of this section.

(3) Minimum size limits are:

(a) Chinook salmon 24 inches

(b) Coho salmon 16 inches, and

(c) No minimum size for other salmon

(4) Gear

(a) Single point barbless hooks only

(b) One rod per angler

(c) For the fishery described in subsection 1(b) of this section, surface flies only; it is unlawful to use or have attached to the fishing line any bait, spoons, plugs, jigs, flashers, dodgers, weights of any kind, diving plane devices, or down riggers.

(5) Shore based angling from the north jetty of the Columbia River is allowed.

**Reviser's note:** The typographical error in the above section occurred in the copy filed by the agency and appears in the Register pursuant to the requirements of RCW 34.08.040.

### REPEALER

The following section of the Washington Administrative Code is repealed:

WAC 220-56-19000V SALTWATER SEASONS AND BAG LIMITS. (92-40)

**WSR 92-15-107**  
**PROPOSED RULES**  
**DEPARTMENT OF AGRICULTURE**

[Filed July 21, 1992, 8:04 a.m.]

#### Original Notice.

Title of Rule: Amend WAC 16-520-040.

Purpose: To change the minimum assessment rate from three cents to one cent per hundredweight.

Statutory Authority for Adoption: Chapter 15.66 RCW.

Statute Being Implemented: RCW 15.66.050.

Summary: Rule change to reduce the minimum assessment rate from three cents to one cent per hundredweight.

Reasons Supporting Proposal: Producers petitioned for this change as provided for in RCW 15.66.050 to reduce the income to the commission.

Name of Agency Personnel Responsible for Drafting: Roger Roberts, Washington State Department of Agriculture, Olympia, Washington 98504, (206) 753-5028; Implementation and Enforcement: Washington Seed Potato Commission, Lynden, Washington 98264, (206) 354-4670.

Name of Proponent: Seven seed potato producers by petition to the director of agriculture, public.

Rule is not necessitated by federal law, federal or state court decision.

Explanation of Rule, its Purpose, and Anticipated Effects: This rule change will reduce the income to the commission. The commission has not had the need to fund research at the rate of its income.

Proposal does not change existing rules.

No small business economic impact statement is required for this proposal by chapter 19.85 RCW.

Hearing Location: Whatcom County Courthouse Annex, 1000 North Forest Street, Bellingham, WA, on September 3, 1992, at 6:00 p.m.

Submit Written Comments to: Roger Roberts, Washington State Department of Agriculture, P.O. Box 42560, Olympia, WA 98504-2560, by September 3, 1992.

Date of Intended Adoption: October 21, 1992.

July 20, 1992

Arthur C. Scheunemann  
Assistant Director

AMENDATORY SECTION (Amending Order 1808, filed 10/25/83, effective 12/1/83)

WAC 16-520-040 ASSESSMENTS AND ASSESSMENT FUNDS. (1) Assessments levied. Beginning December 1, 1983, there is hereby levied and there shall be collected by the commission, as provided in chapter 15.66 RCW, upon all seed potatoes grown in the state an annual assessment which shall be paid by the producer thereof upon each and every hundredweight of seed potatoes sold, processed, delivered for sale or processing by him or stored or delivered for storage when such storage or delivery for storage is outside the boundaries of this state. The assessment shall be three cents per hundredweight from December 1, 1983 until August 31, 1984. The assessment shall then be set by the seed potato commission at a regular meeting before July 15th of each year, to become effective from September 1st of the same year to August 31st of the following year. The assessment shall not be less than ((three cents)) one cent or more than five cents per hundredweight. No assessment may be collected on the following:

(a) Seed potatoes of a producer's own production used by him on his own premises for seed, feed or personal consumption;

(b) Seed potatoes donated or shipped for relief or charitable purposes; or

(c) Sales on a producer's premises by a producer direct to a consumer of five hundred pounds or less of seed potatoes from a producer's own production.

No assessment levied or made collectable by the act under this order shall exceed three percent of the total market value of all such seed potatoes sold, processed or delivered for sale or processing by all producers of seed potatoes for the fiscal year to which the assessment applies.

(2) Collection of assessment.

(a) All assessments made and levied pursuant to the provisions of the act under this marketing order shall apply to the respective producer who shall be primarily liable therefore. To collect such assessments, the commission may require:

(i) Stamps to be known as "Washington seed potato commission stamps" to be purchased from the commission and fixed or attached to the containers, invoices, shipping documents, inspection certificates, releases or receiving receipts or tickets. Any such stamps shall be canceled immediately upon being attached or fixed and the date of such cancellation shall be placed thereon;

(ii) Handlers receiving seed potatoes from the producer, including warehousemen and processors, to collect producer assessments from producers whose production they handle and all monies so collected shall be paid to the commission on or before the twentieth day of the succeeding month for the previous month's collections. Each handler shall at such times as by rule and regulation required, file with the commission a return under oath on forms to be furnished by the commission, stating the quantity of seed potatoes handled, processed, delivered and/or shipped during the period prescribed by the commission.

(iii) Payment of producer assessments before the seed potatoes are shipped off the farm or payments of assessments at different or later times and in such event, any person subject to the assessment shall give such adequate assurance or security for its payment as the commission shall require.

(b) The commission is authorized to make reasonable rules and regulations in accordance and conformity with the act and with this section to effectuate the collection of assessment. On or before the beginning of each marketing season, the commission shall give reasonable notice to all producers, handlers and other affected persons of the method or methods of collection to be used for that marketing season.

(c) No affected units of seed potatoes shall be transported, carried, shipped, sold, stored or otherwise handled or disposed of until every due and payable assessment herein provided for has been paid and the receipt issued or stamp canceled, but no liability hereunder shall attach to common carriers in the regular course of their business. When any seed potatoes for which exemption as provided in subsection (1) of this section is claimed are shipped either by railroad or truck, there shall be plainly noted on the bill of lading, shipping document, container or invoice, the reasons for such exemptions.

(d) Any producer or handler who fails to comply with the provisions of this section as herein provided shall be guilty of a violation of this order.

(3) Funds.

(a) Monies collected by the seed potato commission pursuant to the act and this marketing order as assessments shall be used by the commission only for the purposes of paying for the costs or expenses arising in connection with carrying out the purposes and provisions of the act and this marketing order.

(b) At the end of each fiscal year the commission shall credit each producer with any amount paid by such producer in excess of three percent of the total market value of all seed potatoes sold, processed, delivered for sale or processing or delivered for storage or stored when such storage or delivery for storage was outside the boundaries of this state during that period. Refund may be made only upon satisfactory proof given by the producer in accordance with reasonable rules and regulations prescribed by the director.

Date of Intended Adoption: October 20, 1992.

July 21, 1992  
Fred Olson  
Deputy Director

AMENDATORY SECTION (Amending Order 90-26, filed 10/2/90, effective 11/2/90)

WAC 173-19-450 WHATCOM COUNTY. Whatcom County master program approved August 27, 1976. Revision approved April 11, 1977. Revision approved August 11, 1978. Revision approved December 22, 1981. Revision approved January 5, 1982. Revision approved March 4, 1982. Revision approved December 15, 1982. Revision approved March 1, 1984. Revision approved January 31, 1985. Revision approved June 9, 1987. Revision approved October 2, 1990. Revision approved October 20, 1992.

**WSR 92-15-108  
PROPOSED RULES  
DEPARTMENT OF ECOLOGY**

[Order 92-39—Filed July 21, 1992, 10:11 a.m.]

Original Notice.

Title of Rule: Whatcom County shoreline master program, WAC 173-19-450.

Purpose: Adoption of revised shoreline master program into state master program, chapter 173-19 WAC.

Statutory Authority for Adoption: RCW 90.58.200.

Statute Being Implemented: Chapter 90.58 RCW, Shoreline Management Act of 1971.

Summary: The amendment revises the shoreline master program for Whatcom County.

Reasons Supporting Proposal: Shoreline master programs and revisions thereto are developed by local governments and submitted to the department for approval. The programs do not become effective until adopted by the department in accordance with the Shoreline Management Act and the Administrative Procedure Act.

Name of Agency Personnel Responsible for Drafting: Barry Wenger, Shorelands Program, Baran Hall, St. Martin's Campus, 459-6767; Implementation and Enforcement: D. Rodney Mack, Department of Ecology, Mailstop 7600, Olympia, 98504, 459-6777.

Name of Proponent: Department of Ecology, governmental.

Rule is not necessitated by federal law, federal or state court decision.

Explanation of Rule, its Purpose, and Anticipated Effects: See Summary and Reasons Supporting Proposal above.

Proposal Changes the Following Existing Rules: See Summary and Reasons Supporting Proposal above.

No small business economic impact statement is required for this proposal by chapter 19.85 RCW.

Hearing Location: Fairhaven Library, Second Floor Meeting Room, 1117 Second Street, Bellingham, WA 98225, on August 26, 1992, at 7:00 p.m.

Submit Written Comments to: Master Program Coordinator, Washington State Department of Ecology, Shorelands and Coastal Zone Management Program, Mailstop 7600, Olympia, Washington 98504, by September 2, 1992.

**WSR 92-15-109  
PROPOSED RULES  
DEPARTMENT OF ECOLOGY**

[Order 92-44—Filed July 21, 1992, 10:18 a.m.]

Original Notice.

Title of Rule: City of Tacoma shoreline master program, WAC 173-19-3514.

Purpose: Adoption of revised shoreline master program into state master program, chapter 173-19 WAC.

Statutory Authority for Adoption: RCW 90.58.200.

Statute Being Implemented: Chapter 90.58 RCW, Shoreline Management Act of 1971.

Summary: The amendment revises the shoreline master program for the city of Tacoma, Salmon Beach Area and Thea Foss Waterway.

Reasons Supporting Proposal: Shoreline master programs and revisions thereto are developed by local governments and submitted to the department for approval. The programs do not become effective until adopted by the department in accordance with the Shoreline Management Act and the Administrative Procedure Act.

Name of Agency Personnel Responsible for Drafting: Nora Jewett, Department of Ecology, P.O. 46700, Olympia, WA 98504-6700, (206) 459-6789; Implementation and Enforcement: D. Rodney Mack, Department of Ecology, P.O. 47600, Olympia, WA 98504-6700, (206) 459-6777.

Name of Proponent: Department of Ecology, governmental.

Rule is not necessitated by federal law, federal or state court decision.

Explanation of Rule, its Purpose, and Anticipated Effects: See Summary and Reasons Supporting Proposal above.

Proposal Changes the Following Existing Rules: See Summary and Reasons Supporting Proposal above.

No small business economic impact statement is required for this proposal by chapter 19.85 RCW.

Hearing Location: City Council Chambers, Tacoma Municipal Building, 1st Floor, 747 Market Street, Tacoma, on August 26, 1992, at 5:30-Salmon Beach and 7:00-Thea Foss.

Submit Written Comments to: Master Program Coordinator, Washington State Department of Ecology, Shorelands and Coastal Zone Management Program,

P.O. Box 47600, Olympia, WA 98504, by September 5, 1992.

Date of Intended Adoption: October 20, 1992.

July 21, 1992  
Fred Olson  
Deputy Director

AMENDATORY SECTION (Amending Order 90-05, filed 5/16/90, effective 6/16/90)

WAC 173-19-3514 TACOMA, CITY OF. City of Tacoma master program approved April 5, 1977. Revision approved December 5, 1979. Revision approved March 17, 1981. Revision approved November 23, 1981. Revision approved April 6, 1982. Revision approved May 24, 1983. Revision approved March 1, 1984. Revision approved May 9, 1984. Revision approved April 18, 1985. Revision approved July 23, 1986. Revision approved September 16, 1987. Revision approved May 15, 1990. Revision approved October 20, 1992.

### WSR 92-15-110

#### PROPOSED RULES

#### DEPARTMENT OF ECOLOGY

[Order 92-40—Filed July 21, 1992, 10:27 a.m.]

#### Original Notice.

Title of Rule: San Juan County shoreline master program, WAC 173-19-360.

Purpose: Adoption of revised shoreline master program into state master program, chapter 173-19 WAC. Statutory Authority for Adoption: RCW 90.58.200.

Statute Being Implemented: Chapter 90.58 RCW, Shoreline Management Act of 1971.

Summary: The amendment revises the shoreline master program for San Juan County.

Reasons Supporting Proposal: Shoreline master programs and revisions thereto are developed by local governments and submitted to the department for approval. The programs do not become effective until adopted by the department in accordance with the Shoreline Management Act and the Administrative Procedure Act.

Name of Agency Personnel Responsible for Drafting: Barry Wenger, Shorelands Program, Baran Hall, St. Martin's Campus, 459-6767; Implementation and Enforcement: D. Rodney Mack, Department of Ecology, Mailstop 7600, Olympia, 98504, 459-6777.

Name of Proponent: Department of Ecology, governmental.

Rule is not necessitated by federal law, federal or state court decision.

Explanation of Rule, its Purpose, and Anticipated Effects: See Summary and Reasons Supporting Proposal above.

Proposal Changes the Following Existing Rules: See Summary and Reasons Supporting Proposal above.

No small business economic impact statement is required for this proposal by chapter 19.85 RCW.

Hearing Location: Commissioner's Conference Room, 350 Court Street, Friday Harbor, WA 98250, on August 27, 1992, at 2:00 p.m.

Submit Written Comments to: Master Program Coordinator, Washington State Department of Ecology, Shorelands and Coastal Zone Management Program,

Mailstop 7600, Olympia, WA 98504, by September 3, 1992.

Date of Intended Adoption: October 20, 1992.

July 21, 1992  
Fred Olson  
Deputy Director

AMENDATORY SECTION (Amending Order 91-18, filed 6/5/91, effective 7/6/91)

WAC 173-19-360 SAN JUAN COUNTY. San Juan County master program approved May 28, 1976. Revision approved October 29, 1976. Revision approved April 13, 1981. Revision approved October 30, 1984. Revision approved April 19, 1989. Revision approved March 14, 1990. Revision approved May 15, 1990. Revision approved June 19, 1990. Revision approved February 5, 1991. Revision approved June 4, 1991. Revision approved August 18, 1992. Revision approved October 20, 1992.

### WSR 92-15-111

#### PROPOSED RULES

#### DEPARTMENT OF ECOLOGY

[Order 91-55—Filed July 21, 1992, 10:34 a.m.]

#### Continuance of WSR 92-09-035.

Title of Rule: Amendments to WAC 173-433-100, 173-433-110 and 173-433-170, Solid fuel burning devices.

Purpose: Continue adoption date from July 21, 1992, to September 1, 1992.

Other Identifying Information: The rule is also referred to as the woodstove regulation.

Statutory Authority for Adoption: Chapter 70.94 RCW and 501-506 ESHB 1028 (1991).

Statute Being Implemented: Chapter 70.94 RCW and ESHB 1028 (1991).

Summary: Amendments to reduce air pollution by requiring sale, installation and use of solid fuel burning devices that meet state requirements, increase public awareness, raise additional revenue, remove the exemption of masonry fireplaces, specify new standards for stoves and fireplaces.

Reasons Supporting Proposal: To reduce air pollution and provide additional revenue for education and enforcement.

Name of Agency Personnel Responsible for Drafting: Paul Carr, 4550 3rd Avenue, Lacey, WA, (206) 438-7777; Implementation and Enforcement: Joe Williams, 4550 3rd Avenue, Lacey, WA, (206) 459-6255.

Name of Proponent: Washington State Department of Ecology, governmental.

Rule is not necessitated by federal law, federal or state court decision.

Explanation of Rule, its Purpose, and Anticipated Effects: Amendments to reduce air pollution by requiring sale, installation and use of solid fuel burning devices that meet state requirements, increase public awareness, raise additional revenue, remove the exemption of masonry fireplaces from collection of the retail sales fee, and specify new standards for stoves and fireplaces. Anticipated effects include cleaner air and additional revenue.

Proposal Changes the Following Existing Rules: Increases fee from \$15 to \$30 of retail sale of SFBDs. Removes exemption from retail fee of masonry fireplaces. Adds a 10% capacity level for educational purpose. Implements new emission performance standards for SFBDs on January 1, 1995.

No small business economic impact statement is required for this proposal by chapter 19.85 RCW.

Date of Intended Adoption: September 1, 1992.

July 17, 1992

Fred Olson

Deputy Director

## WSR 92-15-112

### PROPOSED RULES

#### DEPARTMENT OF ECOLOGY

[Order 92-37—Filed July 21, 1992, 10:44 a.m.]

#### Original Notice.

Title of Rule: Chapter 173-03 WAC, Public records.

Purpose: To incorporate changes to ecology's public records rule required by chapter 139, Laws of 1992, providing for a 5 day response time to an individual requesting a record. Also to simplify the rule by incorporating statutory language allowing the department to charge for copies the amount necessary to reimburse its costs for providing copies of records.

Statutory Authority for Adoption: RCW 42.17.250 and 42.17.340.

Statute Being Implemented: Chapter 139, Laws of 1992.

Summary: RCW 42.17.250 Duty to publish procedures, requires that "Each state agency shall separately state and currently publish in the Washington Administrative Code . . . (d)escription of its . . . organization and . . . the methods whereby the public may obtain information . . ." and its "rules of procedure . . ." Chapter 139, Laws of 1992, took effect June 11, 1992.

Reasons Supporting Proposal: To provide a response to a requestor within 5 days, and to clarify that the department may charge to be reimbursed for its costs to provide copies of records.

Name of Agency Personnel Responsible for Drafting and Implementation: Diane W. Pratt, P.O. Box 47600, Olympia, WA, 459-6066; and Enforcement: William M. Wheeler, P.O. Box 47600, Olympia, WA, 459-6179.

Name of Proponent: Washington State Department of Ecology, governmental.

Rule is not necessitated by federal law, federal or state court decision.

Explanation of Rule, its Purpose, and Anticipated Effects: Pursuant to 1992 legislated changes to RCW 42.17.250 to [42.17.]340, Public records, we are required to adopt amendments to our implementing rule, chapter 173-03 WAC, Public records. The 1992 changes to the public records law included the requirement for a 5 day response to a requestor of public records. These rule amendments incorporate that response time change and simplify the rule allowing the department to charge for copying to reimburse its costs. The specific copying

charges are removed from the rule, and the relevant statutory language incorporated, so that future rule amendments are not required every time copying costs increase a few cents per page. Until the department's actual costs rise, the charges per copy will not increase.

Proposal Changes the Following Existing Rules: Only the administrative rule explicitly amended by this action is changed, chapter 173-03 WAC.

No small business economic impact statement is required for this proposal by chapter 19.85 RCW.

#### Economic Compliance Document

Introduction: An amendment to chapter 173-03 WAC, Public records, is being proposed in order to comply with changes required by chapter 139, Laws of 1992. The amendment is necessary due to 1992 legislated modifications to RCW 42.17.250 to 42.17.340, Public records. The changes to the public records rule required the provision of a five day response time to requests for copies of public records and allowed the Department of Ecology to charge an appropriate amount to cover its costs of providing copies of public records. This amendment to chapter 173-03 WAC satisfies the aforementioned criteria and clarifies other parts of the rule as described in the following subsections of the regulation: WAC 173-03-030, the description of Department of Ecology and agency addresses are updated; WAC 173-03-040, public record availability is further detailed; WAC 173-03-060, procedures for responding to requests for public records incorporate the period of five business days for ecology to respond by either providing the record, acknowledging receipt of the request and giving an estimate of the time needed to provide the record, or denying the request; WAC 173-03-070, fees for supplying copies of public records are no longer set at twenty cents per page and may be set by ecology at a level adequate to reimburse it for its costs for providing the copies; and WAC 173-03-100, guidelines for the protection of public records are expanded upon.

Economic compliance: In accordance with the Economic Policy Act, chapter 43.21H RCW, the Department of Ecology must give appropriate consideration to economic values during the rule-making process. The Regulatory Fairness Act (RFA), chapter 19.85 RCW, was adopted in 1982 to minimize proportionately higher economic impacts of state regulations on small businesses. A small business is defined in RCW 43.31.025 as "any business entity (including a sole proprietorship, corporation, partnership, or other legal entity) which is owned and operated independently from all other businesses, which has the purpose of making a profit, and which has fifty or fewer employees." The RFA stipulates that all state agencies proposing regulations which have an economic impact on more than 10% of the businesses in any one industry (as identified by a three-digit SIC code) or on more than 20% of all industries in the state prepare a small business economic impact statement (SBEIS). The SBEIS must include a brief description of compliance requirements of the proposed rule, a description of the professional services needed by businesses to comply with the rule, an analysis of the compliance cost (including administrative costs), and a comparison of the



compliance cost for small firms relative to large ones. The comparison of compliance costs must be based on the cost per employee, the cost per hour of labor required for compliance, the cost per \$1000 of sales revenue, or any combination of these three. If it is found that a rule places a proportionately higher economic burden on small firms then the SBEIS must include suggestions for modifying the proposed rule so as to mitigate its effects on small businesses. Mitigation may be accomplished in a variety of ways including establishing different compliance or reporting requirements for small businesses, clarifying or simplifying the compliance requirements, establishing performance rather than design standards, and exempting small businesses from any or all of the requirements of the rule. The amendments to chapter 173-03 WAC have been reviewed and will impose negligible compliance costs on ecology. The proposed amendment will require no recordkeeping or other actions from anyone other than the Department of Ecology. In general, the types of businesses, agencies and individuals submitting large volume request for documents in the past have been in the following industries: SIC 635, surety insurance; SIC 811, legal services; SIC 873, research, development, and testing services; and SIC 874, management and public relations services. The average size of requests for copies of records from organizations or individuals in these industries is approximately 4,000 pages per request with some requests reaching 12,000 pages in length. The changes to subsection 070, Fees, effectively remove the specific monetary figure of twenty cents per page for providing copies of public records previously stated in the regulation and give the department the ability to raise or lower this fee as needed to adequately cover the total cost of its services. Businesses and individuals may see smaller charges if the department's costs fall or higher charges if costs rise. While the amendment may eventually result in additional fees for some businesses, agencies or individuals, it may reduce fees for other depending on the nature of the request. The fee affects persons outside the Department of Ecology only in instances when they request copies of public records, and it is negligible. Therefore, no small business economic impact statement is required.

Hearing Location: Department of Ecology, St. Martins' Campus, Abbot Raphael Hall, Room 154, Lacey, Washington, on August 25, 1992, at 2:00 p.m.

Submit Written Comments to: Dianne Pratt, Department of Ecology, P.O. Box 47600, Olympia, WA 98504-7600, by September 1, 1992.

Date of Intended Adoption: October 6, 1992.

July 21, 1992  
Fred Olson  
Deputy Director

AMENDATORY SECTION (Amending Order 90-37, filed 10/23/90, effective 11/23/90)

WAC 173-03-030 DESCRIPTION OF ORGANIZATION. (1) Headquarters office.

(a) Through September 1993, the headquarters office ~~((is))~~ will continue to be located in Abbott Raphael Hall on the campus of St. Martin's College, Lacey, Washington. After September 1993, the headquarters office will be located at 300 Desmond Drive East, Lacey,

Washington. The mailing address for the headquarters office and all satellite program offices, except for the environmental investigations and lab services program is:

Department of Ecology  
~~((Mailstop PV-11))~~  
P.O. Box 47600  
Olympia, Washington 98504-~~((8711))~~ 7600

(b) The offices of the director, deputy director, and assistant directors all are located in the headquarters office.

(c) The titles and responsibilities of the seven assistant directors are as follows:

(i) Assistant director for the office of water and shorelands — water quality, water resources, shorelands and coastal zone management, and water quality financial assistance programs.

(ii) Assistant director for the office of central programs and enforcement — central programs, air program, and environmental investigations and lab services program.

(iii) Assistant director for the office of waste management — solid and hazardous waste program, ~~((hazardous waste investigations and))~~ toxics cleanup program, nuclear and mixed waste program, and waste reduction, recycling and litter control program.

(iv) Assistant director for the office of quality control, information management and comprehensive planning.

(v) Assistant director for the office of legislative and intergovernmental affairs.

(vi) Assistant director for the office of financial, personnel, and support services.

(vii) Assistant director for the office of public information and education.

(2) After September 1993, the satellite program offices will be located in the headquarters office. Until September 1993, the satellite program offices are located as follows:

(a) Air program:

~~((Row six Building 4  
4224 6th Avenue S.E.))~~  
College Street Building  
4550 3rd Avenue S.E.  
Lacey, Washington

(b) Budget, accounting, and support services program:

Sawyer Hall  
St. Martin's College Campus  
Lacey, Washington

(c) Central programs:

Abbott Raphael Hall  
St. Martin's College Campus  
Lacey, Washington

2404 Chandler Ct., Suite 260 S.W.  
Olympia, Washington  
(Industrial Section)

Tanglewilde Building  
7240 Martin Way  
Olympia, Washington  
(Sediments/Environmental Review Section)

(d) Environmental investigations and lab services program:

Airustrial Building 8  
~~((7272))~~ Cleanwater Lane #8 7171  
Tumwater, Washington

Mailing address:

~~((Mailstop LH-14))~~  
P.O. Box 47710  
Olympia, WA 98504-~~((6814))~~ 7710

(e) ~~((Hazardous waste investigations and cleanup program:))~~

Toxics Cleanup Program  
Woodland Square  
4415 Woodview Drive S.E.  
Lacey, Washington

(f) Nuclear and mixed waste program:

99 South Sound Center  
Lacey, Washington

7601 W. Clearwater, Suite 102  
Kennewick, WA 99336  
(Kennewick Hanford Project)

- (g) Shorelands and coastal zone management program:  
Baran Hall  
St. Martin's College Campus  
Lacey, Washington
- (h) Solid and hazardous waste program:  
Rowesix Building 4  
4224 6th Avenue S.E.  
Lacey, Washington
- (i) Waste reduction, recycling, and litter control program:  
Eikenberry Building  
4407 Woodview Drive S.E.  
Lacey, Washington
- (j) Water quality financial assistance program:  
Moduline Building  
4500 3rd Avenue  
Lacey, Washington
- (k) Water quality program:  
Prudential Building  
715 Woodview Drive S.E.  
Lacey, Washington
- (l) Water resources program:  
Baran Hall  
St. Martin's College Campus  
Lacey, Washington

(3) Regional offices and their geographical jurisdictions are as follows:

(a) Northwest regional office (Whatcom, Skagit, Snohomish, San Juan, Island, King, and Kitsap counties):

~~((4350 - 150th Avenue N.E.  
Redmond, Washington - 98052-5301))~~  
3190 - 160th Avenue S.E.  
Bellevue, WA 98008-5452

(b) Southwest regional office (Pierce, Thurston, Mason, Clallam, Jefferson, Grays Harbor, Pacific, Lewis, Cowlitz, Wahkiakum, Clark, and Skamania counties):

7272 Cleanwater Lane  
Tumwater, Washington  
Mailing address:  
~~((Mailstop LU-11))~~  
P.O. Box 47775  
Olympia, Washington 98504-~~((6811))~~ 7775

(c) Central regional office (Okanogan, Chelan, Douglas, Kittitas, Yakima, Benton, and Klickitat counties):

106 South 6th Avenue  
Yakima, WA 98902-3387  
3601 W. Washington  
Yakima, Washington 98903-1164  
(Water Resources Program)  
~~((801-B Summitview Ave.  
Yakima, Washington - 98902-3033  
(Waste Management Section))~~  
~~1600 S.W. Perry Street, Suite F  
Yakima, Washington - 98902-5713  
(Yakima Adjudications))~~

(d) Eastern regional office (Ferry, Stevens, Pend Oreille, Grant, Lincoln, Spokane, Adams, Whitman, Franklin, Walla Walla, Columbia, Garfield, and Asotin counties):

N. 4601 Monroe, Suite 100  
Spokane, Washington 99205-1295

**AMENDATORY SECTION** (Amending Order DE 77-35, filed 1/17/78)

WAC 173-03-040 PUBLIC RECORDS AVAILABLE. (1) All public records of the department are available for public inspection

and copying pursuant to these rules subject to subsections (2), (3), ~~((and))~~ (4), and (5) of this section.

(2) Availability of public records is subject to the exemptions and ~~((requirements of))~~ prohibitions against disclosure contained in RCW 42.17.310, 42.17.130, 42.17.255, 42.17.260, and 90.52.020. In addition, individuals may seek, and ecology may grant, confidentiality of documents from disclosure under RCW 43.21A.160 and 70.105.170.

(3) When a public record includes information the disclosure of which would lead to an unreasonable invasion of personal privacy, and the department becomes aware of this fact, the department shall delete such information before making the record available.

(4) Public records requested may not be readily available for immediate inspection. If the requested records are not readily available, the department shall notify the requester when and where such records will be available.

(5) Public records of the department are kept by the department or state archives until scheduled for destruction by the records retention schedule pursuant to chapter 40.14 RCW. Public records which are subject to a request for disclosure when scheduled for destruction shall be retained by the department and shall not be erased or destroyed until the request is resolved.

**AMENDATORY SECTION** (Amending Order 90-37, filed 10/23/90, effective 11/23/90)

WAC 173-03-060 REQUESTS FOR PUBLIC RECORDS. (1) All requests for inspection or copying made in person at a department office shall be made on a form substantially as follows:

REQUEST FOR PUBLIC RECORDS

Date of Request \_\_\_\_\_ Time of Request \_\_\_\_\_

Name \_\_\_\_\_

Address \_\_\_\_\_

Description of Records:

I understand that if a list of individuals is provided me by the Department of Ecology, it will neither be used to promote the election of an official or promote or oppose a ballot proposition as prohibited by RCW 42.17.130 nor for commercial purposes or give or provide access to material to others for commercial purposes as prohibited by RCW 42.17.260(6).

I understand that I will be charged ~~((..... cents per copy for all standard letter size copies I desire and that other size publications are available at cost))~~ the amount necessary to reimburse the department's cost for copying.

Signature \_\_\_\_\_

~~((Number of copies \_\_\_\_\_~~

Number of pages \_\_\_\_\_

Per page charge \$ \_\_\_\_\_

Total charge \$ \_\_\_\_\_))

Number of pages to be copied \_\_\_\_\_

Number of copies per page \_\_\_\_\_

Charge per copy \$ \_\_\_\_\_

Special copy work charge \$ \_\_\_\_\_

Staff time charge \$ \_\_\_\_\_

Total charge \$ \_\_\_\_\_

(2) All requests made in person may be made at a department office between the hours of 8:00 a.m. to 12:00 noon and 1:00 p.m. to 4:30 p.m., Monday through Friday, excluding legal holidays.

(3) A request for inspection or copying of public records may be made by mail in a letter containing the following information:

(a) The name and address of the person making the request and the organization the person represents;

(b) The time of day and calendar date on which the person wishes to inspect the public records;

(c) A description of the public records requested;

(d) A statement whether access to copying equipment is desired;

(e) A phone number where the person can be reached in case the public records officer or designee needs to contact the person for further description of the material or any other reason.

(f) A statement that the record will not be used for commercial purposes.

(4) All requests by mail must be received by the department at least five business days before the requested date of inspection to allow the public records officer or designee to make certain the requested records are available and not exempt and, if necessary, to contact the person requesting inspection. All requests will be handled in a timely manner. However, ~~((for))~~ large requests or requests for public records maintained off-site ~~((; it))~~ may require more than five business days ~~((for location and withdrawal from archives))~~. Within five business days of receiving a public record request, the department will respond by either:

(a) Providing the record;

(b) Acknowledging that the department has received the request and providing a reasonable estimate of the time the department will require to respond to the request; or

(c) Denying the public record request.

Additional time required to respond to a request may be based upon the need to clarify the intent of the request, to locate and assemble the information requested, to notify third persons or agencies affected by the request, or to determine whether any of the information requested is exempt and that a denial should be made as to all or part of the request. In acknowledging receipt of a public record request that is unclear, the department may ask the requestor to clarify what information the requestor is seeking. If the requestor fails to clarify the request, the agency need not respond to it.

(5) The department may in its discretion fill requests made by telephone or facsimile copy (fax).

AMENDATORY SECTION (Amending Order 90-37, filed 10/23/90, effective 11/23/90)

WAC 173-03-070 FEES. No fee shall be charged for the inspection of public records. ~~((For printed, typed, and written material of a maximum size of 8 1/2" by 14", the department shall charge a reasonable fee.))~~ The department will charge an amount necessary to reimburse its costs for providing copies of records. This amount shall be determined from time to time by the department, ((for)) and shall represent the costs of providing copies of public records and for use of the department's copy equipment, ((payable at the time copies are furnished)) including staff time spent copying records, preparing records for copying, and restoring files. This charge is the amount necessary to reimburse the department for its actual costs incident to such copying and shall ((not exceed 20 cents per copy. For copies from microfilm, the charge shall not exceed 40 cents per copy. Copies of maps, photos, reports, computer printouts, tapes of hearings, and other nonstandard items shall be furnished at the regular price established by the department. When other special copy work for nonstandard items is requested, the fee charged will reflect the total cost, including the time of department personnel)) be payable at the time copies are furnished. The charge for special copy work of nonstandard public records shall reflect the total cost, including the staff time necessary to safeguard the integrity of these records.

AMENDATORY SECTION (Amending Order 90-37, filed 10/23/90, effective 11/23/90)

WAC 173-03-100 PROTECTION OF PUBLIC RECORDS. In order to adequately protect the public records of the department, the following guidelines shall be adhered to by any person inspecting such public records:

(1) No public records shall be removed from the department's premises.

(2) Inspection of any public record shall be conducted in the presence of a designated department employee.

(3) No public records may be marked or defaced in any manner during inspection.

(4) Public records which are maintained in a file or jacket, or in chronological or other filing order, or those records, the loss or destruction of which would constitute excessive interference with the department's essential functions, may not be dismantled except for purposes of copying and then only by the public records officer or designee.

(5) Access to file cabinets, shelves, vaults, or other storage areas is restricted to department personnel, unless other arrangements are made with the public records officer or designee.

**WSR 92-15-113**  
**PERMANENT RULES**  
**FOREST PRACTICES BOARD**

[Filed July 21, 1992, 11:15 a.m.]

Date of Adoption: June 26, 1992.

Purpose: To modify forest practices rules, in order to protect public resources while maintaining a viable timber industry.

Citation of Existing Rules Affected by this Order: Amending WAC 222-12-090.

Statutory Authority for Adoption: RCW 76.09.040, 76.09.050, and chapter 34.05 RCW.

Pursuant to notice filed as WSR 92-07-093 on March 18, 1992; and WSR 92-11-069 on May 20, 1992.

Changes Other than Editing from Proposed to Adopted Version: [No information supplied by agency.]

Other Findings Required by Other Provisions of Law as Precondition to Adoption or Effectiveness of Rule: The Forest Practices Board concludes that under RCW 34.05.340 the adopted rule is not substantially different from the rule proposed in WSR 92-11-069.

Effective Date of Rule: Thirty-one days after filing.

July 21, 1992

Brian Boyle

Commissioner of Public Lands

AMENDATORY SECTION (Amending Order 551, Resolution No. 88-1, filed 9/21/88, effective 11/1/88)

WAC 222-12-090 FOREST PRACTICES BOARD MANUAL. When approved by the board the manual serves as an advisory technical supplement to these forest practices regulations. The department, in cooperation with the departments of fisheries, wildlife, agriculture, ecology, and such other agencies, affected Indian tribes, or interested parties as may have appropriate expertise, is directed to prepare, and submit to the board for approval, revisions to the forest practices board manual. The manual shall include:

(1) ~~((Temperature sensitive determinations))~~ Method for determination of adequate shade requirements on streams needed for use with WAC 222-30-040.

(2) ~~((Procedures for leaving the required 50 percent or 75 percent shade as required in WAC 222-30-040.~~

(3) A list of "critical wildlife habitats" as established under WAC 222-16-010(11).

~~((4))~~ (3) The standard methods for measuring channel width, stream gradient and flow which are used in the water typing criteria WAC 222-16-030.

~~((5))~~ (3) A chart for establishing recommended permanent culvert sizes and associated data.

~~((6))~~ (4) Guidelines for clearing slash and debris from Type 4 and 5 Waters.

~~((7))~~ (5) Guidelines for landing location and construction.

~~((8))~~ (6) Guidelines for determining acceptable stocking levels.

~~((9))~~ (7) Guidelines for calculating average widths of riparian management zones.

(8) Guidelines for wetland delineation.

(9) Guidelines for wetland replacement or substitution.

(10) A list of nonnative wetland plant species.

(11) The standard methodology, which shall specify the quantitative methods, indices of resource conditions, and definitions, for conducting watershed analysis under chapter 222-22 WAC. The department, in consultation with Timber/Fish/Wildlife's Cooperative Monitoring, Evaluation and Research Committee (CMER), may make minor modifications to the version of the standard methodology approved by the board. Substantial amendments to the standard methodology requires approval by the board.

(12) A list of special concerns related to aerial application of pesticides developed under WAC 222-16-070(3).

#### WSR 92-15-114

##### PERMANENT RULES

#### DEPARTMENT OF AGRICULTURE

[Order 3005—Filed July 21, 1992, 11:19 a.m.]

Date of Adoption: July 21, 1992.

Purpose: To increase inspection fees from \$18.00 to \$25.00 per hour and to increase the application fee from \$100.00 to \$125.00.

Citation of Existing Rules Affected by this Order: Amending WAC 16-328-010 and 16-333-040.

Statutory Authority for Adoption: Chapter 15.14 RCW.

Pursuant to notice filed as WSR 92-12-056 on June 1, 1992.

Effective Date of Rule: Thirty-one days after filing.

July 21, 1992

Michael V. Schwisow  
Deputy Director  
for C. Alan Pettibone  
Director

#### AMENDATORY SECTION (Amending Order 1932, filed 6/9/87)

WAC 16-328-010 STRAWBERRY PLANT CERTIFICATION FEES. Strawberry plant certification fees are as follows:

(1) Certification application fee. The applicant shall furnish all information requested on the application for inspection and shall allow the department to take plants or plant parts from any planting for inspection or testing purposes. A separate application shall be made for each cultivar and/or unit entered for certification. Each lot of

each cultivar shall be listed separately on the application. Lots under observation by the department shall pay the inspection fees. Applications for inspection shall be filed with the Seed Branch, 2015 South First Street, Yakima, Washington 98903 by June 30 each year accompanied by a one hundred twenty-five dollar fee.

(2) Inspection fees. The inspection fee shall be ~~((eighteen))~~ twenty-five dollars per hour and mileage shall be charged at a rate established by the state office of financial management. Inspection fees shall be payable upon completion of work done and shall be for the sole purpose of defraying expenses incurred in the inspection and certification of strawberry nursery stock. Billing to the applicant shall be made by the seed branch.

(3) A grower desiring to produce certified strawberry plants as herein provided shall establish with the department facts evidencing sufficient experience to produce healthy, high quality stock.

(4) Failure to pay fees when due shall result in removing the applicant from this program.

(5) No application for any grower owing the Washington state department of agriculture for previous fees shall be considered.

#### AMENDATORY SECTION (Amending Order 1932, filed 6/9/87)

WAC 16-333-040 CANEBERRY CERTIFICATION FEES. (1) Caneberry certification application fee. The applicant shall furnish all information requested on the application for inspection and shall allow the department to take plants or plant parts from any planting for inspection and testing purposes. A separate application shall be made for each cultivar and/or unit entered for certification. Each lot of each cultivar shall be listed separately on the application. Lots under observation by the department shall pay the inspection fees. Applications for inspection shall be filed with the seed branch, 2015 South First Street, Yakima, Washington 98903 by May 15 each year accompanied by a one hundred twenty-five dollar fee.

(2) Inspection fees. The inspection fee shall be ~~((eighteen))~~ twenty-five dollars per hour and mileage shall be charged at a rate established by the state office of financial management. Inspection fees shall be payable upon completion of work done and shall be for the sole purpose of defraying expenses incurred in the inspection and certification of caneberry nursery stock. Billing to the applicant shall be made by the seed branch.

(3) Applications for certification shall reach the department's seed branch, 2015 South First Street, Yakima, WA 98903, by May 15 each year.

(4) A grower desiring to produce certified caneberry plants as herein provided shall establish with the department facts evidencing sufficient experience to produce healthy, high quality stock.

(5) Failure to pay fees when due shall result in removing the applicant from the certification program.

(6) No application from any grower owing the department for previous fees shall be considered.

**WSR 92-15-115**  
**PERMANENT RULES**  
**HIGHLINE COMMUNITY COLLEGE**  
 [Filed July 21, 1992, 1:46 p.m.]

Date of Adoption: July 9, 1992.

Purpose: Implement rules and regulations controlling agency facilities, operations, and clients. To meet requirements of state Administrative Procedure Act law.

Citation of Existing Rules Affected by this Order: Repealing WAC 132I-104-010, 132I-104-050, 132I-104-060, 132I-104-070, 132I-120-300, 132I-120-305, 132I-120-310, 132I-120-320, 132I-120-325, 132I-120-335, 132I-120-345, 132I-120-405, 132I-120-420, 132I-120-425, 132I-120-430, 132I-120-440, 132I-160-030, 132I-160-040, 132I-160-050, 132I-160-070, 132I-160-080, 132I-168A-020 and chapters 132I-112, 132I-128, 132I-136 and 132I-168 WAC; and amending WAC 132I-104-030, 132I-104-040, 132I-104-080, 132I-104-090, 132I-104-110, 132I-116-010, 132I-116-090, 132I-116-270, 132I-116-280, 132I-116-300, 132I-120-020, 132I-120-100, 132I-120-400, 132I-120-410, 132I-120-415, 132I-120-435, 132I-120-510, 132I-160-010, 132I-160-020, 132I-160-060, 132I-160-090, 132I-160-100, 132I-160-110, 132I-168A-030, 132I-168A-090, and 132I-168A-100.

Statutory Authority for Adoption: Chapter 34.05 RCW et seq., RCW 28B.50.100 and 28B.50.140.

Pursuant to notice filed as WSR 92-09-152 on April 22, 1992.

Effective Date of Rule: Thirty-one days after filing.

July 20, 1992

Brenda J. Little

Assistant Attorney General

**AMENDATORY SECTION** (Amending Order 005, filed 2/27/74)

WAC 132I-104-030 OFFICERS OF THE BOARD. At the first regular meeting of the board each fiscal year, the board shall elect, from its membership, a ((chairman)) chair and vice ((chairman)) chair to serve for the ensuing year. In addition, the president of Community College District 9 shall serve as secretary to the board of trustees as specified by state law. The secretary may, at his discretion, appoint an appropriate college staff member to act as recording secretary for all regular and special meetings of the board.

(1) The ((chairman)) chair, in addition to any duties imposed by rules and regulations of the state board for community college education, shall preside at each regular or special meeting of the board, sign all legal and official documents recording actions of the board, and review the agenda prepared for each meeting of the board. The ((chairman)) chair shall, while presiding at official meetings, have full right of discussion and vote.

(2) The vice ((chairman)) chair, in addition to any duties imposed by rules and regulations of the state board for community college education shall act as ((chairman)) chair of the board in the absence of the ((chairman)) chair.

(3) The secretary of the board shall be the president of Community College District 9 and shall serve as

((chairman)) chair, without privilege of vote, in any official meeting of the board conducted in the absence of the ((chairman)) chair and vice ((chairman)) chair. In addition to any duties imposed by rules and regulations of the state board for community college education, he shall keep the official seal of the board and maintain all records of meetings and other official actions of the board. The secretary shall also be responsible for board correspondence, compiling the agenda for meetings, and distributing the minutes of the meetings and related reports. The secretary, or his designee, must attend all regular and special meetings of the board, and official minutes must be kept of all such meetings excepting study and executive sessions.

**AMENDATORY SECTION** (Amending Order 005, filed 2/27/74)

WAC 132I-104-040 RESTRICTIONS OF INDIVIDUAL AUTHORITY. Legal authority is vested in the board of trustees and may be exercised only by formal action of the board, taken in regular or special meetings. No individual member of the board may act on behalf of the board unless specifically instructed by action of the board. Three members shall constitute a quorum and no action may be taken with less than a quorum present.

**NEW SECTION**

WAC 132I-104-065 MEETINGS OF THE BOARD OF TRUSTEES. The board customarily holds monthly meetings on the second Thursday of each month at such place as it may designate. Notices of the time and place of all regular and special meetings shall be governed by the requirements of chapter 42.30 RCW, Open Public Meetings Act, as now or hereafter amended.

**AMENDATORY SECTION** (Amending Order 005, filed 2/27/74)

WAC 132I-104-080 INFORMATION FOR BOARD MEMBERS. Any matters of correspondence must be received by the secretary of the board by 12:00 noon ten days before the meeting in order to be included on the agenda. The ((chairman)) chair or secretary may, however, present a matter of business received too late for inclusion on the agenda if in his judgment the expedient consideration of the matter would be beneficial to the college.

**AMENDATORY SECTION** (Amending Order 010, filed 10/31/75)

WAC 132I-104-090 ORDER OF BUSINESS. (1) The order of business governing all regular meetings of the board of trustees shall be as follows:

- (a) Roll call
- (b) Approval of previous minutes
- (c) Correspondence
- (d) Standing reports
- (e) Recommendations for action
- (f) Reports

- (g) Discussion
- (h) Unscheduled business
- (i) New business
- (j) Adjournment

(2) The order of business may be changed by the ~~((chairman))~~ chair with the consent of the board members present. The ~~((chairman))~~ chair may announce at the beginning of each meeting that members of the audience may speak to any item on the agenda at the time of its presentation to the board. The ~~((chairman))~~ chair shall have the right to limit the length of time used by a speaker for the discussion of a subject.

(3) Proposed new policies and/or changes in policy will be presented first to the board of trustees as a report. Board action will be taken normally at a subsequent meeting. If expedient action on the matter would be clearly beneficial to the college, the board may consider, by casting not less than four affirmative votes, taking action at the time the policy is first presented to the board.

AMENDATORY SECTION (Amending Order 005, filed 2/27/74)

WAC 132I-104-110 CHANGES TO BYLAWS OF THE BOARD OF TRUSTEES. The board of trustees may adopt bylaws to govern its operations. A record of these bylaws shall be maintained in the office of the president.

Bylaws of the board may ~~((by))~~ be revised by majority vote of the board provided such changes are proposed at least one regular meeting prior to the meeting at which the vote is taken. Bylaws may be revised by unanimous vote of the board at the same meeting at which the revision is originally proposed.

REPEALER

The following sections of the Washington Administrative Code are repealed:

- WAC 132I-104-010 PURPOSE.
- WAC 132I-104-050 OFFICES OF THE BOARD OF TRUSTEES.
- WAC 132I-104-060 MEETINGS OF THE BOARD OF TRUSTEES.
- WAC 132I-104-070 PARLIAMENTARY PROCEDURE.

Chapter 132I-108 WAC  
MODEL RULES OF PROCEDURE

NEW SECTION

WAC 132I-108-010 ADOPTION OF MODEL RULES OF PROCEDURE. The model rules of procedure adopted by the chief administrative law judge pursuant to RCW 34.05.250, as now or hereafter amended, are hereby adopted for use at this institution. Those rules may be found at chapter 10-08 WAC. Other procedural rules adopted in this title are supplementary to the model rules of procedure. In the case of a conflict between the model rules of procedure and procedural rules adopted in this title, the procedural rules adopted

by this institution shall govern. Rules adopted at this institution prior to July 1, 1989, remain in full force and effect unless specifically repealed or amended.

NEW SECTION

WAC 132I-108-020 APPOINTMENT OF PRESIDING OFFICERS. The president or president's designee shall designate a presiding officer for an adjudicative proceeding. The presiding officer shall be an administrative law judge, or a member in good standing of the Washington State Bar Association, or a panel of individuals, the president or his or her designee, or any combination of the above. When more than one individual is designated to be the presiding officer, one person shall be designated by the president or president's designee to make decisions concerning discovery, closure, means of recording adjudicative proceedings, and similar matters.

NEW SECTION

WAC 132I-108-030 METHOD OF RECORDING. Proceedings shall be recorded by a method determined by the presiding officer, among those available pursuant to the model rules of procedure in WAC 10-08-170.

NEW SECTION

WAC 132I-108-040 APPLICATION FOR ADJUDICATIVE PROCEEDING. An application for an adjudicative proceeding shall be in writing. Application forms are available at the following address:

Highline Community College  
Office of Personnel Services  
PO Box 98000  
Des Moines, WA 98198-9800

Written application for an adjudicative proceeding should be submitted to the above address within twenty days of the agency action giving rise to the application, unless provided for otherwise by statute or rule.

NEW SECTION

WAC 132I-108-050 BRIEF ADJUDICATIVE PROCEDURES. (1) This rule is adopted in accordance with RCW 34.05.482 through 34.05.494, the provisions of which are hereby adopted. Brief adjudicative procedures shall be used in all matters related to:

- (a) Parking violations. The procedural rules in chapter 132I-116 WAC apply to these proceedings;
- (b) Student conduct proceedings. The procedural rules in chapter 132I-120 WAC apply to these proceedings;
- (c) Outstanding debts owed by students or employees. The procedural rules in chapter 132I-122 WAC apply to these proceedings;
- (d) Use of college facilities. The procedural rules in chapter 132I-140 WAC apply to these proceedings;
- (e) Residency determinations made pursuant to RCW 28B.15.013. The procedural rules in chapter 132I-160 WAC apply to these proceedings;
- (f) Use of library—fines. The procedural rules in chapter 132I-168A WAC apply to this section;

(g) Challenges to contents of education records. The procedural rules in chapter 132I-280 WAC apply to these proceedings;

(h) Loss of eligibility for participation in institution sponsored athletic events, pursuant to chapter 69.41 RCW. The procedural rules in chapter 132I-400 WAC apply to these proceedings.

(2) Brief adjudicative proceedings are informal hearings and shall be conducted in a manner which will bring about a prompt fair resolution of the matter.

#### NEW SECTION

WAC 132I-108-060 DISCOVERY. Discovery in adjudicative proceedings may be permitted at the discretion of the presiding officer. In permitting discovery, the presiding officer shall make reference to the civil rules of procedure. The presiding officer shall have the power to control the frequency and nature of discovery permitted, and to order discovery conferences to discuss discovery issues.

#### NEW SECTION

WAC 132I-108-070 ADJUDICATIVE PROCEEDINGS OPEN. Adjudicative proceedings shall be open to the public, except for student disciplinary matters, in compliance with 20 U.S.C. Sec. 1232g, the Family Educational Rights and Privacy Act, unless the student chooses to have the hearing open to the public; and faculty and administrative exempt disciplinary proceedings, unless the person subject of the proceedings chooses to have the hearing open to the public.

#### NEW SECTION

WAC 132I-108-080 PROCEDURE FOR CLOSING PARTS OF THE HEARINGS. A party may apply for a protective order to close part of a hearing. The party making the request should state the reasons for making the application to the presiding officer. If the other party opposes the request, a written response to the request shall be made within ten days of the request to the presiding officer. The presiding officer shall determine which, if any, parts of the proceeding shall be closed, and state the reasons therefor in writing within twenty days of receiving the request.

#### NEW SECTION

WAC 132I-108-090 RECORDING DEVICES. No cameras or recording devices shall be allowed in those parts of proceedings which the presiding officer has determined shall be closed pursuant to WAC 132I-108-070, except for the method of official recording selected by the presiding officer.

#### NEW SECTION

WAC 132I-108-100 PETITIONS FOR STAY OF EFFECTIVENESS. Disposition of a petition for stay of effectiveness of a final order shall be made by the official, officer, or body of officers, who entered the final order.

#### NEW SECTION

WAC 132I-108-110 RECONSIDERATION. (1) A student may file a petition for reconsideration of a final order. Such petition must be filed upon the office of the president within ten days of the service of a final order and must state the specific grounds upon which relief is requested.

(2) No petition for reconsideration may stay the effectiveness of an order.

(3) The petition shall be disposed of by the presiding officer who issued the final order.

#### NEW SECTION

WAC 132I-108-120 ABSENCE OF PRESIDENT. The president may designate another employee of the college to act in his place on a temporary basis during his absence. An employee appointed under this provision shall only have the authority to act upon matters which require a decision by the president within a limited period of time and the president, due to his absence, would be unable to decide such matter.

#### REPEALER

The following chapter of the Washington Administrative Code is repealed:

WAC 132I-112-010 PURPOSE—ELECTIONS AND RECOGNITION.

WAC 132I-112-020 DEFINITIONS.

WAC 132I-112-030 REQUEST FOR ELECTION—CANVASS OF FACULTY EMPLOYEES BY INDEPENDENT AND NEUTRAL PERSON OR ASSOCIATION.

WAC 132I-112-040 NOTICE OF ELECTION—ORGANIZATION TO BE INCLUDED ON BALLOT—TIME FOR FILING.

WAC 132I-112-050 CONTENTS OF NOTICE OF ELECTION—DESIGNATION OF CHIEF ELECTION OFFICER—DUTIES.

WAC 132I-112-060 LISTS OF FACULTY EMPLOYEES—POSTING OF LISTS.

WAC 132I-112-070 ELECTION INSPECTORS—DUTIES—RIGHT TO CHALLENGE VOTER—IMPROPER CONDUCT.

WAC 132I-112-080 BALLOTS.

WAC 132I-112-090 RECORD OF VOTE—SIGNATURE—CHALLENGE.

WAC 132I-112-100 INCORRECTLY MARKED BALLOT.

WAC 132I-112-110 PRIVACY FOR VOTER—EQUIPMENT.

WAC 132I-112-120 FOLDING BALLOT—BALLOT BOX.

WAC 132I-112-130 CHALLENGED BALLOT—PROCEDURE.

WAC 132I-112-140 EMPLOYEES PRESENT ENTITLED TO VOTE—SEALING BALLOT BOX—UNUSED BALLOTS.

WAC 132I-112-150 ELECTION INSPECTORS DUTIES AFTER VOTING HAS TERMINATED.

WAC 132I-112-160 DISPOSITION OF CHALLENGED BALLOTS—TALLY SHEETS—INVESTIGATION BY CHIEF ELECTION OFFICER.

WAC 132I-112-170 COUNTING OF BALLOTS—PROCEDURE—CERTIFICATION OF RESULTS OF ELECTION—RETENTION OF BALLOTS—SIGNED VOTING LISTS.

WAC 132I-112-180 ELECTIONEERING WITHIN THE POLLS FORBIDDEN.

WAC 132I-112-190 CONTEST OF ELECTION—TIME FOR FILING OBJECTIONS—INVESTIGATION OF OBJECTIONS.

WAC 132I-112-200 PERSONS ELIGIBLE TO VOTE.

WAC 132I-112-210 ELECTION DETERMINED BY MAJORITY OF VALID VOTES CAST CALCULATED ON A WEIGHTED BASIS—RUN-OFF ELECTION.

WAC 132I-112-220 INCLUSION OF THOSE HOLDING ADMINISTRATIVE APPOINTMENTS EXCEPT CHIEF EXECUTIVE OFFICER.

WAC 132I-112-230 TIME LAPSE FOR NEW ELECTION.

WAC 132I-112-240 CERTIFICATION OF ACADEMIC EMPLOYEES' REPRESENTATIVE.

AMENDATORY SECTION (Amending Order 020, filed 6/26/84)

WAC 132I-116-010 PURPOSE. Pursuant to RCW 28B.50.140(10), as now or hereafter amended, the board of trustees of Highline Community College District 9 is granted authority to make rules and regulations for pedestrian and vehicular traffic over property owned, operated, or maintained by the college district. The purposes of parking and traffic rules and regulations are:

(1) To protect and control pedestrian and vehicular traffic.

(2) To assure access at all times for emergency equipment.

(3) To minimize traffic disturbances during class hours.

(4) To facilitate the operation of the community college of the district by assuring access for vehicles and to regulate the use of parking spaces.

AMENDATORY SECTION (Amending Order 020, filed 6/26/84)

WAC 132I-116-090 DISPLAY OF PERMIT. The parking permit issued by the college shall be permanently affixed on the inside of the rear window on the lower left corner directly behind the driver. If the vehicle is a convertible or a truck camper, or has no permanently fixed rear window, the permit shall be displayed on the front windshield. Permits not displayed in accordance with the provisions of this section shall not be valid and vehicles displaying the improperly placed permit shall be subject to citation. Permits shall be displayed on the front fender of a motorcycle, scooter, or bicycle.

AMENDATORY SECTION (Amending Order 020, filed 6/26/84)

WAC 132I-116-270 FINES AND PENALTIES. (1) Fines may be levied for all violations of the rules and regulations contained in WAC 132I-116-260.

In addition to a fine imposed under these regulations, illegally parked vehicle(s) may be taken to a place for storage as the campus police chief selects. The expenses of such impoundings and storage shall be the responsibility of the registered owner or driver of the vehicle. The college shall not be liable for loss or damage of any kind resulting from such impounding and storage.

(2) Parking and traffic fines and penalties schedule shall be adopted by the board of trustees. ~~((This schedule shall be published and made available for public review in the campus security office.))~~

(3) An accumulation of traffic violations by a student shall be cause for disciplinary action, and the dean of students may initiate disciplinary proceedings against such students.

(4) An accumulation of traffic violations by faculty or staff members shall be turned over to the controller for the collection of fines not received by the vice president, or his designee.

(5) Parking and traffic violations will be processed by the college. Parking and traffic fines are to be paid to the campus security office.

(6) The schedule of fines shall be reviewed by a parking advisory committee appointed by the student affairs council as requested by the dean of students or the vice president.

(7) Parking and traffic fines shall be charged for offenses as indicated in a separate document.

(8) In the event a student fails or refuses to pay a fine, the following may result:

(a) Student may not be eligible to register;

(b) Student may not be able to obtain a transcript or his grades or credits;

(c) Student may not receive a degree until all fines are paid;

(d) Student may be denied future parking privileges;

(e) Vehicle may be impounded.

(9) Parking and traffic fines are due twenty days from the date of citation. Provided that if an appeal is taken, such fine shall be due twenty days from the date of service upon the violator of the result of the appeal.

NEW SECTION

WAC 132I-116-275 SCHEDULE OF FINES AND PENALTIES. Highline Community College parking and traffic fine schedule is as follows:

**Parked in wrong area (student in staff or visitor area)	\$5.00
**Parked in no parking zone	5.00
**Parked in firelane	5.00
**improperly parked - i.e., parked in a manner to obstruct traffic; occupying more than one space or over separator line; backed into stall (must be head-in); space not designated for parking	5.00



**\*\*** no current hcc parking permit displayed 5.00  
**\*** no parking permit displayed – \$5.00.  
 (Fine will be reduced to one dollar if the citation is returned to the campus security office within five school days from date of issuance and a current parking permit is picked up during the five school-day period.)  
 first violation only:

**\*\*** all of the above fines are \$5.00 for the first offense, and all subsequent offenses are \$15.00 each.

No current handicap permit	\$25.00
Speeding	10.00
Reckless/negligent driving	10.00
Failure to yield right-of-way	10.00
Failure to stop for stop sign	10.00
Wrong way on one-way road	10.00
Others – i.e., use of permit for vehicle other than to which registered; improper display of permit; use of forged, lost, or stolen permit	5.00

effective winter quarter 1992

**AMENDATORY SECTION** (Amending Order 020, filed 6/26/84)

WAC 132I-116-280 PARKING FEES. Parking fees shall be adopted by the board of trustees, specifying the charge per year and quarter. ~~((The fee schedule shall be published and made available for public review in the campus security office.))~~

**NEW SECTION**

WAC 132I-116-285 SCHEDULE OF PARKING FEES. Highline Community College parking fees are as follows:

parking fees:

Students registered for 0-5 credits	\$5.00 per quarter
Students registered for 6 or more credits	\$8.00 per quarter
Part-time faculty and staff	\$5.00 per quarter
Full-time faculty and staff	\$8.00 per quarter
Motorcycles, motorbikes, scooters	\$5.00 per quarter
Additional, replacement/second car	\$3.00 per quarter
Car pool permits (5 or more people)	No charge
Each additional vehicle in car pool (5 or more people)	No charge
Senior citizens registering under tuition waiver	\$3.00 per quarter
Annual permits (4 quarters)	\$29.00
Annual permits (3 quarters)	\$24.00
Special rates (summer quarters)	\$5.00 per quarter

All other registered students, i.e., community service self-supporting programs, GED will pay a \$.25 daily fee, any other exceptions must see the campus police chief in the campus security office. These fees include the state sales tax as required.

**AMENDATORY SECTION** (Amending Order 020, filed 6/26/84)

WAC 132I-116-300 APPEAL OF FINES AND PENALTIES. Any fines and penalties levied against a

violator of the rules and regulations set forth herein, may be appealed. The appeal must be made in writing, within ~~((five college))~~ twenty calendar days from the date of the citation, to the campus police chief, who will:

(1) Review the appeal to determine whether a satisfactory solution, to all parties, can be reached without further administrative action.

(2) If the appellant is not satisfied with the decision of the campus police chief, an appeal may be made, in writing, to the college's vice president within ~~((seven working))~~ twenty-one calendar days of the appellant's receipt of the decision. Within twenty working days from the receipt of any such appeal, the college's vice president shall render a written decision. The dean of administration's decision will be final.

~~((3))~~ ~~((If the appellant is not satisfied with the decision of the college's vice president, an appeal may be made to the college's president within seven days of the receipt of the vice president's decision.~~

~~((4))~~ The final legal recourse for an appellant is to the Washington state superior court system.

~~((5))~~ (4) In the event that the appeal involves an impounded vehicle, the owner of such vehicle shall have the right to a hearing within ~~((48 hours of a request for such))~~ forty-eight hours of a request, or the first work-day after impoundment if the vehicle is impounded on a Friday or on a Thursday if a three-day weekend, whichever is longer, for such, before the campus police chief. The owner of the vehicle shall also be entitled to a release of his vehicle upon payment of a bond in the amount of the sum of the impoundment costs and the total of all fines due and owing. If at the hearing it is shown that the vehicle was improperly impounded, the owner of the vehicle shall be entitled to a refund of the costs of impoundment.

~~((6))~~ (5) In all appeals under this section, the appellant carries the burden of proof, which shall be a preponderance of the evidence.

**AMENDATORY SECTION** (Amending Order 022, filed 3/23/88)

WAC 132I-120-020 GENERAL POLICIES. (1) Highline Community College is an agency of the state of Washington and adheres to all local, state, and federal laws. The college is obligated to demonstrate respect for laws by cooperating in their enforcement.

(2) Highline Community College cannot and will not establish regulations which would abridge constitutional rights.

(3) Proper procedures are established to maintain conditions conducive to the effective performance of the function of the college, to protect individual students from unfair imposition of penalties, and to assure due process. Highline Community College is granted the right by law to adopt such rules as are deemed necessary to govern its operations.

(4) If these rules are broken, the college has the right and the obligation to take that action which is in the best interest of the entire college and which is commensurate with the constitutional rights of the individual.

(5) If a student is charged with an off-campus violation of the law, the matter shall be of no disciplinary

concern to the college unless the student is incarcerated and unable to comply with academic requirements. If the violation of law occurs on campus and is also a violation of a published college regulation, the college may institute its own proceedings against the offender or may refer the violation to the appropriate civilian authorities for disposition. The college shall not proceed with a disciplinary action that in fact or appearance duplicates punishment for the same offense unless the interests of the college are implicated in some separate way by violation of law.

(6) The Highline College Student Union will have the right to participate in the formulation and ~~((reviewing))~~ review of all policies and rules pertaining to student conduct and in the enforcement of all such rules as provided by these rules.

(7) Rules of conduct and procedures of enforcement shall be printed and made available to all students.

(8) All rules herein adopted concerning student conduct shall apply to every student attending the college in any college facility.

AMENDATORY SECTION (Amending Order 022, filed 3/23/88)

WAC 132I-120-100 STUDENT RESPONSIBILITIES. (1) Students who choose to attend Highline Community College also choose to participate actively in the adult learning process offered by the college. As a process, learning is not a product or commodity which is bought and sold, but rather, is a relationship between teachers who are willing and competent to teach and learners who are willing and competent to learn. Therefore, the responsibility for learning is shared equally between students and staff.

(2) The college is responsible for providing its students ~~((and))~~ with an educational environment rich in the high quality resources needed by students to attain their individual educational goals. In return, students are responsible for making themselves aware of the full breadth of the resources available, for the timely choosing and appropriate use of those resources, and for the specific behavioral tasks necessary for attaining desired learning outcomes. Examples of specific student responsibilities are:

- (a) To become knowledgeable of and adhere to the college's policies, practices, and procedures;
- (b) To participate actively in the learning process, both in and out of the classroom;
- (c) To seek timely assistance in meeting educational goals;
- (d) To attend all class sessions;
- (e) To adequately prepare to participate fully in class activities;
- (f) To participate actively in the advising system,
- (g) To develop skills required for learning, e.g., basic skills, time management, motivation, study skills, and openness to the educational process;
- (h) To assume final authority for the selection of appropriate educational goals;
- (i) To select courses appropriate for meeting chosen educational goals;

(j) To evaluate the quality and quantity of resources available to students; and

(k) To contribute towards improving the college.

(3) As members of the Highline community, students are expected to obey all college rules and regulations and are prohibited from engaging in any unlawful conduct. Any student shall be subject to disciplinary action as provided for in this chapter (see WAC 132I-120-410) who, either as a principal actor, aider, abettor, or accomplice as defined in RCW 9A.08.020, as now law or hereafter amended, interferes with the personal rights or privileges of others or the educational process of the college; violates any provision of this chapter; or commits any of the following personal, property or status offenses which are hereby prohibited:

(a) Personal offenses.

(i) Assault, reckless endangerment, intimidation, or interference upon another person in the manner set forth in RCW 9A.36.010, 9A.36.020, 9A.36.030, 9A.36.040, 9A.36.050, or 28B.10.570 through 28B.10.572, as now law or hereafter amended.

(ii) Disorderly, abusive, or bothersome conduct. Disorderly or abusive behavior which interferes with the rights of others or which obstructs or disrupts teaching, research, or administrative functions.

(iii) Failure to follow instructions. Inattentiveness, inability, or failure of student to follow instructor's instructions, thereby infringing upon the rights and privileges of other students.

(iv) Illegal assembly, obstruction, or disruption. Any assembly or other act which materially and substantially interferes with vehicular or pedestrian traffic, classes, hearings, meetings, the educational and administrative functions of the college, or the private rights and privileges of others.

(v) False complaint. Filing a formal complaint falsely accusing another student or college employee with violating a provision of this chapter.

(vi) False alarms. Falsely setting off or otherwise tampering with any emergency safety equipment, alarm, or other device established for the safety of individuals and/or college facilities.

(vii) Sexual harassment. Engaging in unwelcome sexual advances, requests for sexual favors, and other verbal or physical conduct of a sexual nature where such behavior offends the recipient, causes discomfort or humiliation, or interferes with job or school performance.

(b) Property offenses.

(i) Theft or robbery. Theft of the property of the district or of another as defined in the RCW 9A.56.010 through 9A.56.060 and 9A.56.100 as now law or hereafter amended.

(ii) Malicious mischief. Intentional or negligent damage to or destruction of any college facility or other public or private real or personal property.

(iii) Unauthorized use of college equipment and supplies. Converting of college equipment or supplies for personal gain or use without proper authority.

(c) Status offenses.

(i) Cheating and plagiarism. Submitting to a faculty member any work product that the student fraudulently represents to the faculty member as the student's work

product for the purpose of fulfilling any assignment or task required by the faculty member as part of the student's program of instruction.

(ii) Forgery or alteration of records. Forging or tendering any forged records or instruments, as defined in RCW 9A.60.010 through 9A.60.020 as now law or hereafter amended, of any district record or instrument to an employee or agent of the district acting in his official capacity as such.

(iii) Refusal to provide identification in appropriate circumstances. Refusal to provide positive identification (e.g., valid driver's license or state identification card) in appropriate circumstances to any college employee in the lawful discharge of said employee's duties.

(iv) Illegal entry. Entering any administrative or other employee office or any locked or otherwise closed college facility in any manner, at any time, without permission of the college employee or agent in charge thereof.

(v) Smoking. Smoking in any classroom or laboratory, the library, or in any college facility or office posted "no smoking" or any other smoking not in compliance with chapter 70.160 RCW as now law or hereafter amended.

(vi) Controlled substances. Using, possessing, being demonstrably under the influence of, or selling any narcotic or controlled substance as defined in chapter 69.50 RCW as now law or hereafter amended, except when the use or possession of a drug is specifically prescribed as medication by an authorized medical doctor or dentist. For the purpose of this regulation, "sale" shall include the statutory meaning defined in RCW 69.50.410 as now law or hereafter amended.

(vii) Alcoholic beverages. Being demonstrably under the influence of any form of alcoholic beverage. Possessing or consuming any form of alcoholic beverage on college property, with the exception of sanctioned events, approved by the president or his or her designee in compliance with state law.

(d) Failure to comply with the following regulations governing firearms and weapons:

(i) It shall be the policy of the college that carrying, exhibiting, displaying, or drawing any weapon, such as a dagger, sword, knife, or any other cutting or stabbing instrument or club or any other weapons apparently capable of producing bodily harm and/or property damage is prohibited on or in college facilities.

(ii) Explosives, incendiary devices, or any weapon facsimile are prohibited on or in college facilities.

(iii) It shall be the policy of the college that carrying of firearms on college facilities is prohibited except and unless the firearm is registered with the campus security for a specific period of time that the firearm is carried on campus.

(iv) The above regulations shall not apply to equipment or material owned, used, or maintained, by the college; nor will they apply to law enforcement officers.

## NEW SECTION

**WAC 132I-120-105 STUDENT RIGHTS.** The following enumerated rights are guaranteed to each student within the limitations of statutory law and college policy which are deemed necessary to achieve the educational goals of the college:

(1) Academic freedom.

(a) Students are guaranteed the rights of free inquiry, expression, and assembly upon and within college facilities that are generally open and available to the public.

(b) Students are free to pursue appropriate educational objectives from among the college's curricula, programs, and services, subject to the limitations of RCW 28B.50.090 (3)(b).

(c) Students shall be protected from academic evaluation which is arbitrary, prejudiced, or capricious, but are responsible for meeting the standards of academic performance established by each of their instructors.

(d) Students have the right to a learning environment which is free from unlawful discrimination, inappropriate and disrespectful conduct, and sexual harassment.

(2) Due process.

(a) The rights of students to be secure in their persons, quarters, papers, and effects against unreasonable searches and seizures is guaranteed.

(b) No disciplinary sanction may be imposed on any student without notice to the accused of the nature of the charges.

(c) A student accused of violating this code of student rights and responsibilities is entitled, upon request, to procedural due process as set forth in this chapter.

(3) Distribution and posting. Students may distribute or post printed or published material subject to official procedures printed and available in the dean of students office. All free publications not in violation of state and/or federal laws such as books, magazines, newspapers, handbills, leaflets, or similar materials may be distributed on campus. The college may restrict the distribution of any publications, where such distribution unreasonably interferes with college operations. Such materials may be distributed from authorized public areas in the student center and at any outdoor area on campus consistent with the maintenance of college property, with the free flow of traffic and persons, and not in a manner which in itself limits the orderly operation of college affairs. Any person desiring to distribute such publications shall first register with the dean of students so that reasonable areas and times can be assured and the activities of the institution will not be unduly interfered with. All handbills, leaflets, newspapers, and similarly related matter must bear identification as to the publishing agency and distributing organization or individual.

(4) Off-campus speakers. Recognized student organizations shall have the right to invite outside speakers to speak on campus subject to the availability of campus facilities, funding, and compliance with the college procedures available in the administrative office.

(5) Incidental sales. Students have the right to engage in incidental sales of personal property in a private transaction provided college facilities are not explicitly used for this purpose.

(6) Commercial activities. The use of college grounds or facilities for commercial or private gain purposes is prohibited except where commercial activity such as sale of books, instructional supplies, or food contribute to the operation of the instructional program or where limited sale is specifically authorized by the dean of students for the benefit of an approved activity.

(7) Fund raising. Students have the right to engage in fund raising activities for nonprofit organizations as recognized by the Internal Revenue Service. All fund raising activities must be approved by the dean of students.

(8) Sale of merchandise. All merchandise offered for commercial sale may be sold only through the college bookstore or college food services except when approved by the dean of students.

AMENDATORY SECTION (Amending Order 023, filed 3/27/89)

WAC 132I-120-400 AUTHORITY AND RESPONSIBILITY FOR DISCIPLINE. (1) The board of trustees acting in accordance with Washington state statutes does by written order delegate to the president of the college authority to administer disciplinary action. All disciplinary action in which there is a recommendation that a student be suspended or expelled from the college shall be acted upon by the president as defined in WAC 132I-120-030 (1)(g).

(2) Administration of the disciplinary procedure is the responsibility of the dean of students.

(3) The instructor is responsible for conduct in the classroom and is authorized to take such steps as are necessary when behavior of the student interrupts the normal classroom procedure. When such behavior may be so serious as to result in expulsion from the class, the instructor must report the infraction in writing to the dean of students at the earliest opportunity.

(4) The student has the right to appeal any disciplinary action of an instructor to the dean of students(=

~~(5) Students bringing children on campus are governed by existing state laws concerning their responsibility for the children)) as in accordance with the procedures set forth in WAC 132I-120-426 through 132I-120-432.~~

AMENDATORY SECTION (Amending Order 023, filed 3/27/89)

WAC 132I-120-410 DEFINITION OF DISCIPLINARY ACTION. The following disciplinary action may be imposed upon students according to the procedure outlined in WAC (~~(132I-120-420)~~) 132I-120-421.

(1) Admonition: An oral statement to a student that there is a violation and that continued violation may be cause for further disciplinary action.

(2) Warning: Notice in writing that continuation or repetition of conduct deemed wrongful, within a period of time stated in the warning, may be cause for more severe disciplinary action.

(3) Disciplinary probation: Formal action placing specific conditions upon the student's continued attendance and warning the student that further misconduct may subject him/her to dismissal.

(4) Restitution: Reimbursement for damage to or misappropriation of property. This may take the form of appropriate service or other compensation.

~~(5) ((Administrative withdrawal: Exclusion from classes and other privileges or activities in accordance with WAC 132I-120-430.~~

~~(6) Interim emergency withdrawal)) Summary suspension: Exclusion from classes and other privileges or activities in accordance with WAC ((132I-120-425)) 132I-120-426.~~

~~((7))~~ (6) Suspension: Exclusion from classes and other privileges or activities as set forth in the notice for a definite period of time.

~~((8))~~ (7) Dismissal: Termination of student status for an indefinite period of time. Conditions of reinstatement, if any, shall be stated in the order of dismissal.

AMENDATORY SECTION (Amending Order 022, filed 3/23/88)

WAC 132I-120-415 AUTHORITY TO REQUEST IDENTIFICATION. In situations of apparent misconduct or apparent unauthorized presence in a college facility, it may be necessary for properly identified college personnel to ask a person to produce evidence of being a currently enrolled student at the college. Failure to comply with a legitimate request for identification from a properly identified college personnel is a violation of this chapter (see WAC 132I-120-100 (c)(iii)) and may result in a disciplinary action if the person is found to be a student. In emergency situations, cases of serious misconduct or where there is a substantial danger to the college community or college property, failure to produce identification ((as)) by a student may result in the assumption by college personnel that the person questioned is not a student and may result in direct civil or criminal action.

NEW SECTION

WAC 132I-120-421 INITIAL DISCIPLINARY PROCEEDINGS. (1) All disciplinary proceedings will be initiated by the appropriate dean or his or her designated representative. The student may be placed on suspension pending commencement of disciplinary action, pursuant to the conditions set forth in WAC 132I-120-426.

(2) Any student accused of violating any provision of the rules of conduct shall be called for an initial meeting and receive written notice of such meeting by first class mail with the appropriate dean or his or her designated representative. The student will be informed in writing of what provision or provisions of the rules of conduct he/she is charged with violating, and what appears to be the range of penalties, if any, which might result from initiation of disciplinary proceedings.

(3) After considering the evidence in the case and interviewing the accused student, if the accused student has appeared at the initial meeting, the dean may take any of the following actions:

(a) Terminate the proceeding, exonerating the student or students;

(b) Dismiss the case after whatever counseling and advice the dean deems appropriate;

(c) Impose verbal warning to student directly, not subject to the students right of appeal as provided in this chapter;

(d) Impose additional sanctions of reprimand, probation, suspension, or dismissal, subject to the student's right of appeal as provided in the following provisions.

#### NEW SECTION

WAC 132I-120-424 SUMMARY SUSPENSION—PURPOSE. The purpose of WAC 132I-120-426 through 132I-120-432 is to establish rules implementing RCW 34.05.410 (1)(b) and 34.05.479.

#### NEW SECTION

WAC 132I-120-426 SUMMARY SUSPENSION PROCEEDINGS. (1) If a dean or his or her designee(s) has cause to believe that any student:

- (a) Has committed a felony; or
- (b) Has violated any provision of this chapter; and
- (c) Presents an imminent danger either to himself or herself, other persons on the college campus, or to the educational process; that student shall be summarily suspended and shall be served by certified and regular mail at the student's last known address, or shall be personally served.

Summary suspension is appropriate only where (c) of this subsection can be shown, either alone or in conjunction with (a) or (b) of this subsection. The dean or his or her designee shall enter an order as provided by law if the student is to be suspended.

(2) The notice shall be entitled "notice of summary suspension proceedings" and shall state:

(a) The charges against the student including reference to the provisions of WAC 132I-120-100 or statutory law involved; and

(b) That the student charged must appear before the appropriate dean or his or her designee at a time specified in the notice for a hearing. The hearing shall be held as soon as practical after the summary suspension.

#### NEW SECTION

WAC 132I-120-427 PROCEDURES OF SUMMARY SUSPENSION HEARING. (1) The summary suspension hearing shall be considered an emergency adjudicative proceeding. The proceeding must be conducted as soon as possible and the appropriate dean will preside over the meeting.

(2) The dean shall, at a summary suspension proceeding, determine whether there is probable cause to believe that continued suspension is necessary and/or whether some disciplinary action is appropriate.

#### NEW SECTION

WAC 132I-120-428 DECISION BY THE DEAN. If the dean, following the conclusion of the summary suspension hearing, finds that there is probable cause to believe that:

(1) The student against whom specific violations are alleged has actually committed one or more such violations; and

(2) Summary suspension of said student is necessary for the safety of the student, other students or persons

on college facilities, the educational process of the institution, or to restore order to the campus; and

(3) Such violation or violations constitute grounds for disciplinary action as provided for in WAC 132I-120-100; then the dean may continue to enforce the suspension of the student from college and may impose any other disciplinary action appropriate.

#### NEW SECTION

WAC 132I-120-429 NOTICE OF SUSPENSION.

(1) If a student's summary suspension is upheld or if the student is otherwise disciplined, the student will be provided with a written notice including the dean's findings of fact and conclusions which lead the dean to believe that the summary suspension of the student should continue.

(2) The student suspended pursuant to the authority of this rule shall be served a copy of the notice of suspension by personal service or by certified and regular mail at the student's last known address within three working days following the conclusion of the hearing with the dean.

(3) The notice of suspension shall state the duration of the suspension or nature of the disciplinary action and conditions under which the suspension may be terminated.

#### NEW SECTION

WAC 132I-120-431 SUSPENSION FOR FAILURE TO APPEAR. The dean is authorized to enforce the suspension of the summarily suspended student in the event the student has been served pursuant to the notice requirement and fails to appear at the time designated for the summary suspension proceeding.

#### NEW SECTION

WAC 132I-120-432 APPEALS FROM SUMMARY SUSPENSION HEARING. Any student aggrieved by an order issued at the summary suspension proceeding may appeal to the discipline committee. No such appeal shall be entertained, however, unless:

(1) The student has first appeared before the appropriate dean at the student hearing in accordance with WAC 132I-120-427;

(2) The student has been officially notified of the outcome of the hearing;

(3) Summary suspension or other disciplinary sanction has been upheld; and

(4) The appeal conforms to the standards set forth in WAC 132I-120-441(2).

The discipline committee shall, within five working days, conduct a formal hearing in the manner described in WAC 132I-120-442.

AMENDATORY SECTION (Amending Order 022, filed 3/23/88)

WAC 132I-120-435 DISCIPLINE COMMITTEE. The college discipline committee will hear and make recommendations on all disciplinary cases referred

to it by the dean of students or appealed to it by students who have been disciplined by the dean.

(1) The college discipline committee will be composed of the following members:

(a) A ((chairperson)) chair will be designated by the president of the college for a period of one year. The ((chairperson)) chair will be nonvoting. It is the responsibility of the ((chairperson)) chair to ensure that all procedural guidelines specified in WAC 132I-120-440 are followed, to take whatever steps are necessary during the hearing itself to ensure that the hearing is conducted in a safe and orderly manner, to advise the members of the committee concerning precedents and guidelines affecting the individual case, and to inform the student in writing of the action taken by the college discipline committee following the hearing.

(b) Two faculty members recommended by the faculty senate and appointed by the president. Two alternatives shall be recommended and appointed to serve in the event that appointees are unable to serve or complete their term. The committee members shall serve for one year terms.

(c) Two full-time student representatives shall be chosen by the HCSU in such manner as the members thereof shall determine. For the purposes of these rules a full-time student shall be defined as currently enrolled in twelve or more credit hours. Two alternates shall be appointed to serve in the event that members are unable to serve or complete their term.

(2) The committee shall be formed as early as possible in the fall quarter and shall be convened by the dean of students during the first four weeks of fall quarter to discuss these rules. Other meetings may be held as determined by the chairperson or requested by the committee members.

(3) Faculty or student members may be excused from service for the entire year, for a particular period of time, or after a particular case. Replacement of excused members shall be made from respective panels.

#### NEW SECTION

WAC 132I-120-441 APPEALS OF DISCIPLINARY ACTION—GENERALLY. (1) Appeals contesting any disciplinary action may be made by the student(s) involved. Such appeals shall be made in the following order:

(a) Disciplinary action taken by the dean or his or her designee(s) may be appealed to the discipline committee, which may, at the request of the dean, hear the case de novo.

(b) Disciplinary recommendations made by the discipline committee may be appealed by the student to the president of the college. The president shall review the record of the proceedings which give rise to the appeal, as well as the recommendations made by the dean and the discipline committee. The president's decision shall be final.

(2) Any appeal by a student receiving a disciplinary sanction must meet the following conditions:

(a) The appeal must be in writing and must clearly state errors in fact or matters in extenuation or mitigation which justify the appeal; and

(b) The appeal must be filed within twenty-one days from the date of service upon the student of notice that disciplinary action was being taken.

(3) All decisions shall be sent from the office of the dean to the president. Written decisions shall include the signature of the discipline committee chair. Copies shall be sent to the president of the college or his or her designee and the student involved in the proceeding.

#### NEW SECTION

WAC 132I-120-442 HEARING PROCEDURES BEFORE THE DISCIPLINE COMMITTEE. (1) The discipline committee shall conduct a hearing within fourteen working days after disciplinary action has been referred to it.

(2) When a person is charged with an offense punishable by suspension, or dismissal of his or her relationship with the institution, and where the person:

(a) Waives the opportunity for a brief adjudicative proceeding; or

(b) By his conduct in the judgment of the hearing officer makes it impossible to conduct a brief adjudicative proceeding; or

(c) Is dissatisfied with the results of the brief adjudicative proceeding; that person is entitled to an adjudicative proceeding according to the provisions of RCW 34.05.410 and the guidelines of this chapter. Where an adjudicative proceeding is neither required by law nor requested by the student or the college, the matter may be resolved informally. Brief adjudicative proceedings before the discipline committee shall be conducted in any manner which will bring about a prompt, fair resolution of the matter.

(3) The student has a right to a fair and impartial hearing before the discipline committee on any charge of violating the rules of conduct. However, the student's failure to cooperate with the committee's hearing procedures shall not preclude the discipline committee from making its findings of fact, conclusions, and recommendations.

(4) The student may be represented by counsel of his or her choice at the disciplinary hearing. If the student elects to choose a duly licensed attorney admitted to practice in the state of Washington as counsel, the student shall notify the chair at least five working days prior to the hearing.

(5) In all disciplinary proceedings, the college may be represented by a designee appointed by the president. That designee will then present the college's case against the student accused of violating the rules of conduct; provided, that in those cases in which the student elects to be represented by a licensed attorney, the president may elect to have the college represented by an assistant attorney general.

(6) The record in a formal hearing shall consist of all documents as required by law and as specified in RCW 34.05.476 as new law or hereafter amended.

(7) All records of disciplinary proceedings shall be maintained in the administrative office and shall be available only during the course of the disciplinary proceedings to the discipline committee, the student, and

his/her attorney, and any other other college official designated by the president.

(8) Following the conclusion of the disciplinary proceeding, access to records of the case and the hearing files will be limited to those designated by the college president.

(9) Following final disposition of the case and any appeals therefrom, the president may direct the destruction of any records of any disciplinary proceedings, provided that such destruction is in conformance with the requirements of chapter 40.14 RCW, as now law or hereafter amended.

(10) The time of the hearing may be advanced by the discipline committee at the request of the student or continued for good cause.

(11) If at any time during the hearing a visitor disrupts the proceedings, the chair of the discipline committee may exclude that person from the hearing room.

(12) Any student of the college attending the disciplinary hearing who continues to disrupt the proceedings after the presiding officer has asked him/her to cease or to leave the hearing room, shall be subject to disciplinary action.

#### NEW SECTION

WAC 132I-120-443 EVIDENCE ADMISSIBLE IN HEARINGS. (1) Only those matters presented at the hearing, in the presence of the accused student (except where the student fails to attend after receipt of proper notice) will be considered in determining whether the discipline committee has sufficient cause to believe that the accused student is guilty of violating the rules he or she is charged with having violated. Hearsay evidence is admissible in the hearing.

(2) The presiding officer of the discipline committee shall, in the course of presiding at the disciplinary hearing, give effect to the rules of privilege recognized by law and exclude incompetent, irrelevant, immaterial, and unduly repetitious evidence.

(3) Evidence or testimony to be offered by or on behalf of the student in extenuation or mitigation shall not be presented or considered until all substantive evidence or testimony has been presented.

#### NEW SECTION

WAC 132I-120-444 DECISION BY THE DISCIPLINE COMMITTEE. (1) Upon conclusion of the disciplinary hearing, the discipline committee shall consider all the evidence therein presented and decide by majority vote whether to uphold the initial disciplinary action or to recommend institution of any of the following actions:

(a) That the college terminate the proceedings and exonerate the student; or

(b) That the college impose any of the disciplinary actions as provided in this chapter.

(2) The committee's written decision shall include findings of fact, conclusions of law, and recommendations for the final disposition of the matter at issue.

(3) Within seven working days of the conclusion of the hearing, the student will be provided with a copy of the committee's findings of fact and conclusions. The

copy shall be dated and contain a statement advising the student of his or her right, to submit a written statement to the president of the college appealing the recommendation of the discipline committee.

#### NEW SECTION

WAC 132I-120-450 FINAL APPEAL. Any student who is aggrieved by the findings or conclusions of an appeal to the discipline committee may appeal the same in writing to the president within twenty-one days of service of notice upon the student of the action taken by the committee. The president may, at his or her discretion, suspend any disciplinary action pending determination of the merits of the findings, conclusions and disciplinary actions imposed. In the consideration of such an appeal, the president shall base his findings and decision only on the official written record of the case.

#### AMENDATORY SECTION (Amending Order 022, filed 3/23/88)

WAC 132I-120-510 MEMBERSHIP OF REVIEW COMMITTEE. (1) The review committee shall be composed of eight members. Four of these members shall be students appointed by the HCSU (~~chairperson~~) chair. Four members shall be appointed by the dean of students. Each member shall have one vote. The dean of students shall serve as a nonvoting (~~chairperson~~) chair.

(2) The term of office shall be for one academic year starting at the beginning of fall quarter.

#### NEW SECTION

WAC 132I-120-530 JURISDICTION. (1) All rules adopted in this chapter shall apply to every student whenever said student is present upon or in any college facility and whenever said student is present at or engaged in any college-sponsored activity which is held on or in noncollege facilities.

(2) Faculty members, other college employees, students, and members of the public who breach or aid or abet another in the breach of any provision of this chapter shall be subject to:

(a) Possible prosecution under the state criminal law;

(b) Any other civil or criminal remedies available to the public; or

(c) Appropriate disciplinary action pursuant to the state of Washington higher education personnel board rules or the district's policies and regulations.

#### REPEALER

The following sections of the Washington Administrative Code are repealed:

WAC 132I-120-300 RIGHT OF ACADEMIC FREEDOM.

WAC 132I-120-305 RIGHT OF EQUAL PROTECTION.

WAC 132I-120-310 RIGHT OF ACCESS TO COLLEGE FACILITIES.

WAC 132I-120-320 RIGHT TO INVITE OUTSIDE SPEAKERS.



WAC 132I-120-325 RIGHT OF PUBLICATION.  
 WAC 132I-120-335 RIGHT OF SALE AND  
 DISTRIBUTION OF MATERIAL AND RIGHT TO  
 CONDUCT FUND RAISING ACTIVITIES.

WAC 132I-120-345 RIGHT TO PRIVACY OF  
 RECORDS.

WAC 132I-120-405 VIOLATIONS.

WAC 132I-120-420 DISCIPLINARY  
 PROCEDURE.

WAC 132I-120-425 EMERGENCY  
 WITHDRAWAL.

WAC 132I-120-430 ADMINISTRATIVE  
 WITHDRAWAL.

WAC 132I-120-440 PROCEDURE OF THE  
 COLLEGE DISCIPLINE COMMITTEE.

Chapter 132I-122 WAC  
 WITHHOLDING SERVICES FOR OUTSTANDING  
 DEBTS

NEW SECTION

WAC 132I-122-010 STATEMENT OF POLICY.  
 The college expects that students who receive services  
 for which a financial obligation is incurred will exercise  
 responsibility in meeting these obligations. Appropriate  
 college staff are empowered to act in accordance with  
 regularly adopted procedures to carry out the intent of  
 this policy, and if necessary to initiate legal action to in-  
 sure that collection matters are brought to a timely and  
 satisfactory conclusion.

Admission to or registration with the college, confer-  
 ring of degrees and issuance of academic transcripts may  
 be withheld for failure to meet financial obligations to  
 the college.

NEW SECTION

WAC 132I-122-020 WITHHOLDING SER-  
 VICES FOR OUTSTANDING DEBTS. Upon receipt  
 of a request for services where there is an outstanding  
 debt due the institution from the requesting person, the  
 institution shall notify the person, in writing by certified  
 mail to the last known address, that the services will not  
 be provided since there is an outstanding debt due the  
 institution, and further that until that debt is satisfied,  
 no such services will be provided to the individual.

Notification that services will be withheld shall also  
 inform the individual that he or she has a right to a  
 hearing before a person designated by the president of  
 the institution if he or she believes that no debt is owed.  
 Notification shall also indicate that the request for the  
 hearing must be made within twenty-one days from the  
 date such notice is received. Upon receipt of a timely  
 request for a hearing, the person designated by the pres-  
 ident shall have the records and files of the institution  
 available for review and, at that time, shall hold a brief  
 adjudicative proceeding concerning whether the individ-  
 ual owes or owed any outstanding debts to the institu-  
 tion. After the brief adjudicative proceeding, an order  
 shall be entered by the president's designee indicating  
 whether the institution is correct in withholding services  
 and/or applying off set for the outstanding debt. If the

outstanding debt is found to be owed by the individual  
 involved, no further services shall be provided. The order  
 and notice of discontinued service shall be sent to the  
 individual within ten days after the hearing.

NEW SECTION

WAC 132I-122-030 APPEAL OF INITIAL OR-  
 DER UPHOLDING THE WITHHOLDING OF SER-  
 VICES FOR OUTSTANDING DEBTS. Any person  
 aggrieved by an order issued under 132I-122-020 may  
 file an appeal with the president. The appeal must be in  
 writing and must clearly state errors in fact or matters  
 in extenuation or mitigation which justify the appeal.  
 The appeal must be filed within twenty-one days from  
 the date on which the appellant received notification of  
 the order issued under WAC 132I-122-020 upholding  
 the withholding of services for outstanding debts. The  
 president's determination shall be final.

Chapter 132I-124 WAC  
 GENERAL CONDUCT

NEW SECTION

WAC 132I-124-010 SMOKING. It shall be the  
 policy of Highline Community College, consistent with  
 its efforts to promote wellness, fitness, and a campus en-  
 vironment conducive to work, study, and activities for  
 staff, students, and the public to maintain a smoke/to-  
 bacco free indoor campus environment. Use of tobacco  
 products is permitted on campus outside of the build-  
 ings. Receptacles for smoking materials are provided and  
 all are urged to use them to maintain litter free campus  
 grounds.

The college recognizes the rights of those who choose  
 to use tobacco and as such does not prohibit the use of  
 tobacco products; it does, however, restrict the use of  
 these materials to areas outside college facilities and  
 vehicles.

REPEALER

The following chapter of the Washington Administra-  
 tive Code is repealed:

WAC 132I-128-011 PREAMBLE.

WAC 132I-128-021 DEFINITIONS.

WAC 132I-128-031 COMMITTEE  
 COMPOSITION.

WAC 132I-128-041 TENURE REVIEW COM-  
 MITTEE FUNCTIONS—ESTABLISHING  
 CRITERIA.

WAC 132I-128-051 TENURE REVIEW COM-  
 MITTEE FUNCTIONS—ONGOING  
 RESPONSIBILITIES.

WAC 132I-128-061 TENURE REVIEW COM-  
 MITTEE FUNCTIONS—PROBATIONER  
 COMPLAINTS.

WAC 132I-128-071 WORKING COMMIT-  
 TEES—FUNCTIONS.

WAC 132I-128-081 TENURE REVIEW COM-  
 MITTEE—TENURE RECOMMENDATION.



WAC 132I-128-091 CONSIDERATION OF TENURE REVIEW COMMITTEE RECOMMENDATIONS BY THE APPOINTING AUTHORITY.

WAC 132I-128-101 PROCEDURES FOR GRANTING TENURE—ADDITIONAL PROVISIONS.

WAC 132I-128-110 APPEALS REVIEW COMMITTEE—COMPOSITION.

WAC 132I-128-120 APPEALS REVIEW COMMITTEE—FORMATION.

WAC 132I-128-130 APPEALS REVIEW COMMITTEE—FUNCTIONS.

WAC 132I-128-140 NOTICE OF DISMISSAL.

WAC 132I-128-150 APPEALS REVIEW COMMITTEE—FORMAL PROCEEDINGS.

WAC 132I-128-160 PRESENTATION OF CASE.

WAC 132I-128-170 CLOSED HEARING.

WAC 132I-128-180 CONSIDERATION BY BOARD OF TRUSTEES.

WAC 132I-128-190 PUBLICITY.

WAC 132I-128-200 APPEAL FROM THE DECISION OF THE APPEALS REVIEW COMMITTEE AND THE APPOINTING AUTHORITY.

WAC 132I-128-310 FACULTY GRIEVANCE PROCEDURES—PURPOSE.

WAC 132I-128-320 DEFINITIONS.

WAC 132I-128-330 PROCEDURES.

WAC 132I-128-340 ADDITIONAL PROVISIONS.

WAC 132I-128-350 JURISDICTION OF THE ARBITRATOR.

WAC 132I-128-360 APPEAL OF ARBITRATION.

WAC 132I-128-800 RETIREMENT PLAN MEMBERSHIP.

WAC 132I-128-810 OASI DEDUCTIONS.

WAC 132I-128-820 RETIREMENT AGE.

Chapter 132I-130 WAC  
TUITION AND FEE SCHEDULE

NEW SECTION

WAC 132I-130-010 TUITION AND FEE SCHEDULES. Chapter 28B.15 RCW sets the parameters for tuition and fee levels at state community colleges. The legislature establishes the tuition and fee rates each biennium. The tuition and fee rates charged by Highline are based on this legislation, the specific amounts to be charged are transmitted to Highline Community College by the state board for community college education.

NEW SECTION

WAC 132I-130-020 LOCATION OF SCHEDULES. Additional and detailed information and specific amounts to be charged for each category of students will be found in the class schedule and at the following locations on the Highline campus:

- (1) The office of admissions;
- (2) The registration and records office;

- (3) The controller's office;
- (4) The continuing education office.

Chapter 132I-131 WAC  
SCHOLARSHIPS

NEW SECTION

WAC 132I-131-010 SCHOLARSHIPS. Detailed information concerning the criteria, eligibility, procedures for application, and other information regarding scholarships may be obtained at the following address:

Highline Community College  
Attn: Scholarships  
PO Box 98000  
2400 South 240th Street  
Des Moines, WA 98198-9800

Chapter 132I-132 WAC  
FINANCIAL AID

NEW SECTION

WAC 132I-132-010 FINANCIAL AID. Federal, state, and private financial aid applications and information may be obtained at the following address:

Highline Community College  
Attn: Office of Financial Aid  
PO Box 98000  
2400 South 240th Street  
Des Moines, WA 98198-9800

Award of federal and state aid will be made in accordance with applicable federal and state laws and regulations.

Chapter 132I-133 WAC  
ORGANIZATION

NEW SECTION

WAC 132I-133-010 ORGANIZATION—OPERATION—INFORMATION. (1) Organization. Community College District No. 9 is established in Title 28B RCW as a public institution of higher education. The institution is governed by a five-member board of trustees, appointed by the governor. The board employs a president, who is the chief executive officer of the institution. The president establishes the structure of the administration.

(2) Operation. The administrative office is located at the following address:

Highline Community College  
PO Box 98000  
2400 South 240th Street  
Des Moines, WA 98198-9800

The office hours are 8:00 a.m. to 5:00 p.m., Monday through Friday, except legal holidays.

(3) Information. Additional and detailed information concerning the educational operations and course offerings may be obtained from the catalog, copies of which are available at the following address:

Highline Community College  
 PO Box 98000  
 2400 South 240th Street  
 Des Moines, WA 98198-9800

Chapter 132I-134 WAC  
**DESIGNATION OF RULES COORDINATOR**

NEW SECTION

WAC 132I-134-010 **RULES COORDINATOR.**  
 The rules coordinator for this institution shall have an office located at the office of the director of personnel, with the following mailing address:

Highline Community College  
 Office of Personnel Services  
 PO Box 98000  
 2400 South 240th Street  
 Des Moines, WA 98198-9800

REPEALER

The following chapter of the Washington Administrative Code is repealed:

- WAC 132I-136-100 **PURPOSE.**
- WAC 132I-136-110 **RIGHT TO DENY USE OF FACILITIES.**
- WAC 132I-136-120 **BASIS OF FEE ASSESSMENT.**
- WAC 132I-136-130 **APPLICATION PROCEDURES.**
- WAC 132I-136-140 **SUPERVISION DURING ACTIVITY.**
- WAC 132I-136-150 **CARE AND MAINTENANCE OF FACILITIES AND EQUIPMENT.**
- WAC 132I-136-160 **ATHLETIC FACILITIES.**
- WAC 132I-136-170 **LIABILITY FOR DAMAGE.**

Chapter 132I-140 WAC  
**USE OF FACILITIES**

NEW SECTION

WAC 132I-140-010 **PURPOSE.** The trustees of Highline Community College believe that educational and community service opportunities are extended to the community when the college's buildings, grounds, and facilities are made available for use by the students, faculty, administration, staff, and the community. This use shall not interfere with regular college activities and shall be in accordance with the public interest, welfare, laws of the state of Washington, and in the best interest(s) of the college as interpreted by the administration of Highline Community College and/or the board of trustees.

Intended or actual use in conflict with these policies or construed to be in any way detrimental to the college's best interests and/or original intent for that facility are strictly prohibited.

NEW SECTION

WAC 132I-140-015 **TRESPASS.** (1) Individuals who are not students or members of the faculty or staff

and who violate these regulations will be advised of the specific nature of the violation, and if they persist in the violation, they will be requested by the president, or his or her designee, to leave the college property. Such a request prohibits the entry of and withdraws the license or privilege to enter onto or remain upon any portion of the college facilities by the person or group of persons requested to leave. Such persons shall be subject to arrest under the provisions of chapter 9A.52 RCW, as not law or hereafter amended.

(2) Members of the college community (students, faculty, and staff) who do not comply with these regulations will be reported to the appropriate college office or agency for action in accord with established college policies.

(3) Persons who violate a district policy may have their license or privilege to be on district property revoked and be ordered to withdraw from and refrain from entering upon any district property. Remaining on or re-entering district property after one's license or privilege to be on that property has been revoked shall constitute trespass and such individual shall be subject to arrest for criminal trespass.

NEW SECTION

WAC 132I-140-016 **PROHIBITED CONDUCT AT COLLEGE FACILITIES.** (1) State law governs the use or possession of intoxicants on campus or at college functions. The use or possession of unlawful drugs or narcotics, not medically prescribed, on college property or at college functions, is prohibited. Students obviously under the influence of intoxicants, unlawful drugs, or narcotics while in college facilities shall be subject to disciplinary action.

(2) The use of tobacco is restricted by law and by regulations of the smoking policy to designated smoking areas.

(3) Destruction of public property is prohibited by state law.

NEW SECTION

WAC 132I-140-110 **RIGHT TO DENY USE OF FACILITIES.** (1) The trustees reserve the right to deny facility use to individuals or groups of a private nature whose activities, be they secret or otherwise, are inconsistent with the open and public nature of Highline Community College and where such use would conflict with the purpose of state and federal laws against discrimination.

(2) If at any time actual use of college facilities by the individual or group constitutes an unreasonable disruption of the normal operation of the college, such use shall immediately terminate, all persons engaged in such use shall immediately vacate the premises, and leave the college property upon command of the appropriate college official.

(3) Any individual or group granted permission to use college facilities shall agree in advance to abide by all college rules and regulations. The college reserves the right to deny use of college facilities to any individual or

group whose past conduct indicates a likelihood that college rules and regulations will not be obeyed.

(4) No single group shall be allowed use of facilities on a regular or continuing basis.

#### NEW SECTION

**WAC 132I-140-120 BASIS OF FEE ASSESSMENT.** (1) The basis for establishing and charging use fees reflects the college's assessment of the present market, the cost of operations, and an evaluation of the intended purpose and its relationship to the purposes of this college. The position of the board of trustees is that groups or organizations affiliated with the college should be permitted access to facilities at the lowest charge on the fee schedule which may include complimentary use. A current fee schedule is available to interested persons from the office of continuing education.

(2) The college does not wish to compete with private enterprise. Therefore, the college reserves the right to deny applications for facility use when the administration and/or the board of trustees believes a commercial facility can be patronized. At no time shall facility use be granted for a commercial activity at a rental rate, or upon terms, less than the full and fair rental value of premises used.

#### NEW SECTION

**WAC 132I-140-130 APPLICATION PROCEDURES.** (1) At least seven college working days prior to date of intended use of any college facility, an authorized representative of the requesting organization must submit proper and complete written application on a "use of facility" form which may be obtained through the college's office of community services. A single application may be sufficient for a series of meetings by an organization unless those meetings vary significantly in some substantive way; then separate applications will be required.

(2) Upon approval of the application, an authorized representative of the using organization shall sign the rental agreement. By affixing a signature as representing the using organization, the signatory specifies he or she has authority to enter into agreement on behalf of the organization and if the organization fails to pay the amount due, the signatory becomes responsible for all charges which may include interest payment for overdue accounts as specified on the rental form but not less than one percent per month.

(3) Large events, events requiring expenditures on the part of the college, or where significant areas are made available to the renter; a minimum of up to fifty percent advance deposit may be required at the time of application.

(4) The college reserves the right to make pricing changes without prior written notice.

(5) Use of a facility is limited to the facilities specified on the agreement.

(6) The priorities for facility use place primary emphasis on regular college events and activities. The board of trustees reserves the right to cancel any permit and

refund any payments for use of college facilities and equipment if the groups use of college facilities and/or equipment would violate any federal, state, local, or school law, regulation, or rule or when the planned use could subject the college to any liability.

(7) In the event of a cancellation of a facility use permit by the applicant, that organization is liable for all college costs and expenses in preparing the facility for its use.

(8) The decision to issue permits is based on the assumption that any admission charges are to be specified and approved by the college.

(9) Organizations using Highline Community College's facilities shall conduct all activities in accordance with all applicable local, state, and federal laws including the rules and regulations adopted by Community College District 9 as stated in Title 132I WAC and in the use of facility form.

#### NEW SECTION

**WAC 132I-140-134 REQUEST FOR BRIEF ADJUDICATIVE PROCEEDING OVER DENIAL OF FACILITY USE.** Any organization that is denied use of college facilities may challenge said denial by filing an appeal as specified in WAC 132I-140-135(2) with the president's designee.

Upon receipt of such appeal, the president's designee shall hold a brief adjudicative proceeding.

#### NEW SECTION

**WAC 132I-140-135 APPEAL OF DENIAL OF FACILITY USE.** (1) Any organization whose application for facility use has been denied may appeal such decision to the president.

(2) The appeal must be in writing and must clearly state errors in fact or matters in extenuation or mitigation which justify the appeal. The appeal must be filed within twenty-one days from the date of service upon appellant of the order denying use of facilities.

(3) The president's determination shall be final.

#### NEW SECTION

**WAC 132I-140-140 SUPERVISION DURING ACTIVITY.** (1) Signatories of the rental agreement as well as adult organization leaders are responsible for group conduct and are expected to remain with their group during activities. When the use of special facilities makes it necessary that supervision be provided, the trustees reserve the right to require a staff member represent the college at any activity on Highline Community College facilities. Such service shall be paid at the current rate, by the organization requesting use of the facility (see WAC 132I-140-160), and does not relieve the organization from safeguarding the college's property.

(2) The security staff or some other authority of the college will open and lock all rented facilities. Keys to buildings or facilities will not be issued or loaned on any occasion to any using organization with the exception of keys to designated off-campus locations.

NEW SECTION

WAC 132I-140-150 CARE AND MAINTENANCE OF FACILITIES AND EQUIPMENT. (1) College-owned equipment shall not be removed from college facilities for loan or rental. Organizations wishing to use equipment in connection with a rental should make arrangements through the office of continuing education at the time of application. Further rental and operational restrictions may be outlined when the application is approved.

(2) Appropriate equipment is expected when using facilities when the absence of such special equipment may be detrimental to that facility (e.g., tennis shoes must be worn on gymnasium floors).

(3) Organizations allowed use of facilities are required to leave premises in as good condition as when the organization was admitted to its use. After facility use, organizations are required to arrange for proper disposal of decorations and other refuse when restoring the facility to its original condition for resumption of college use.

(4) Custodial and other services beyond those regularly scheduled to support normal college activities may be required for specific activities by outside groups, based on the size of group, the complexities of the event, or the facilities being used. Needed custodial services beyond that normally scheduled will result in that organization being charged at the established rate. All extra custodial time required as a result of the organization's use of the facility will be charged to the organization, including those receiving complimentary usage.

(5) The security staff should be contacted for problems with facilities. The security staff will monitor any permit violations.

(6) All moving of college equipment for facility use will be under permission and supervision of the college.

(7) Any decoration or use of facility that may result in permanent damage or injury to the facility is strictly prohibited.

NEW SECTION

WAC 132I-140-160 ATHLETIC FACILITIES. (1) Highline Community College playing fields may be used by community members and groups provided such use does not interfere with regular college activities and that proper permits for use of college grounds have been secured for activities other than unorganized casual use.

(2) Highline Community College allows only highly restricted use in scheduling the use of the swimming pool. Permitted users shall comply with all pool regulations, as determined by the college. Such regulations may vary based on the anticipated use. Applications should be made on a use of facility form obtained through the college's office of continuing education. A condition of rental is the college's right to set forth the number of lifeguards and to select and hire these lifeguards on its own criteria. Cost of usage will include these employee's salaries and other personnel expenses.

(3) The pavilion may be used by community organizations subject to the same restrictions and regulations governing the use of other facilities. Because of the size

of the facility, most users will be required to have college personnel on site during usage. Cost of usage will include these employee's salaries and other personnel expenses.

NEW SECTION

WAC 132I-140-170 LIABILITY FOR DAMAGE. The lessee of college facilities, including agreement signatories and individual organizations leaders, shall be liable for any damage to college property occurring or having apparently occurred during the time the facility was being used by the organization. The lessee also agrees to hold harmless and indemnify Highline Community College, its agents, employees, officers, trustees, students and/or attorneys for any claim made against the college as a result of the lessee's use of college facilities. The college reserves the right to require using organizations to purchase insurance, naming the college as the insured, and may specify the amount of that insurance.

AMENDATORY SECTION (Amending Order 013, filed 1/6/76)

WAC 132I-160-010 PURPOSE. (~~Highline Community College is chartered under the laws of the state of Washington (chapter 28B.50 RCW) to provide "... comprehensive education training and service programs to meet the needs of both the communities and students served by combining, with equal emphasis, high standards of excellence in academic transfer courses; realistic and practical courses in occupational education, both graded and ungraded; and community services of an educational, cultural, and recreational nature; and adult education."~~ As an assurance that the greatest number of citizens benefit from this commitment, the board of trustees of Highline Community College is dedicated to an "open door" policy of admission. Admission and registration materials and information, including specific eligibility requirements, deadlines, and fees are available to all inquirers through the Office of Admissions and/or the Registrar's Office, Highline Community College, South 240th and Pacific Highway South, Midway, Washington 98031 (206-878-3710, extensions 361 and 242).) The purpose of these policies and procedures is to establish a standard set of admission and registration practices that are necessary and appropriate for the administration of Highline Community College. For admission information contact the Admission Office, Highline Community College, 2400 South 240th Street, P.O. Box 98000, Des Moines, Washington 98198-9800. For registration information contact the registrar's office at the same address.

AMENDATORY SECTION (Amending Order 013, filed 1/6/76)

WAC 132I-160-020 DEFINITIONS. (~~These incorporated definitions reflect the minimum admissions standards outlined by Highline Community College's office of admissions. All definitions, policies and procedures stated herein are in alignment with appropriate sections of the Revised Code of Washington statutes and~~

Highline Community College policies and procedures, as duly adopted by the Community College District No. Nine board of trustees:

(1) Applicant: Any person seeking admission to Highline Community College and who meets the minimum standards for community college admission as stated in WAC 132I-160-030.

(2) Matriculated student: Persons granted admission to Highline Community College, according to the procedures stated herein, are defined as "matriculated students."

(3) Veteran: Matriculated students, as defined by WAC 132I-160-020(2) and who were documented veterans of any branch of the United States Armed Forces are defined as "veterans."

(4) Vietnam veterans: Matriculated students as defined by WAC 132I-160-020(2) and who are also veterans, as defined by WAC 132I-160-020(3), having documented service in Cambodia, Laos, Thailand, or Vietnam during the period of August 5, 1964 to April 11, 1975.

(5) Foreign students: Persons applying or having applied for matriculation to Highline Community College, who are non-United States citizens, having satisfied all United States immigration requirements and completed all forms required by the United States immigration service, having satisfactorily completed the test of English as a foreign language (TOEFL) or Highline Community College English proficiency test, or equivalent, and having met the requirements stated on all Highline Community College foreign student forms (available through the office of admissions and registration) are defined as "foreign students."

(6) Former students: Students who formerly matriculated, as defined by WAC 132I-160-020(2), and who ceased course work at Highline for at least one quarter and are seeking readmission, are defined as "former students."

(7) Continuing students: Matriculated students, as defined by WAC 132I-160-020(2), wishing to register for the next quarter following the one in which they are presently enrolled are defined as "continuing students."

(8) Special students: Persons meeting the admission requirements of the Washington State Community College Act, but have not made formal application for admission to the college or any specific occupational program. These students may register for classes on a space available basis after "matriculated" students have completed the registration schedule.

(9) G.E.D.: The general educational development test is generally for the person 19 years old or older. Successful completion of the G.E.D. test means that a person has learned enough through experience, job training, and other informal educational experiences to have an education equivalent to a high school diploma.

(10) Resident student: A person who can provide documented evidence of being domiciled in the state of Washington, as specified in chapter 28B.15 RCW, for one year prior to the beginning of the term for which he registered, is defined as a resident. Exceptions are briefly described under WAC 132I-160-060.

(11) Nonresident student: Is any person who isn't considered a resident student as defined under WAC 132I-160-020(10).

(12) Student's file: A special file for each applicant and admitted student is maintained by the office of admissions and contains all of the documents pertaining to admission to Highline Community College (WAC 132I-160-030), and all official transcripts as submitted by other colleges and institutions. These materials are also available for later use by the counseling staff.

(13) Cumulative advising folder: A file similar to that maintained by the counseling center will be prepared and presented to each new matriculated student upon admission with the understanding that the student will maintain and update the information within that file as an aid for program planning in subsequent quarters.)  
The following terms are defined below:

(1) Applicants: Persons seeking admission to Highline Community College.

(2) Students: Applicants granted admission to Highline Community College.

(3) Veterans: Applicants or students who are eligible to receive Department of Veterans' Affairs Educational Benefits.

(4) Vietnam veterans: Veterans who have documented service in Cambodia, Laos, Thailand, or Vietnam during the period of August 5, 1964, to April 11, 1975.

(5) International students: Applicants or students who are not United States citizens and who need F-1 or J-1 visas to attend Highline Community College.

(6) Newly admitted students: Students who have not previously attended Highline Community College.

(7) Currently enrolled students: Students who are registered in credit courses in the current quarter who wish to register for the following quarter. Students may skip summer quarter and maintain this status.

(8) Former students: Students who were registered in credit courses in a previous quarter but who are not currently enrolled in credit courses.

(9) Resident students: Resident students are applicants who can prove they have lived in Washington state for the entire year before the start of the quarter in which they register. Resident status may also be extended under certain conditions to Washington state higher education employees, federal employees, military personnel, and some veterans. These rules may extend to spouses, minor children, and dependents under most circumstances. More detailed definition is available in RCW 28B.15.012. A copy of the Revised Code of Washington is available in the Highline Community College library.

(10) Nonresident students: Students who meet the definition according to RCW 28B.15.012(3). A copy of the Revised Code of Washington is available in the Highline Community College library.

(11) Not regularly admitted students: Students who are eighteen years old or older and who do not have a high school diploma or GED.

(12) Registration by appointment: The initial period of registration for each quarter. Students and applicants are assigned days and times to register based upon the

number of credits earned at Highline Community College. Students and applicants who wish to register for evening, Saturday, or continuing education courses do not require registration appointments. Those students register on a first-come, first-served basis during open enrollment.

(13) Late registration: The period of registration after registration by appointment. It continues through the end of the first week of the quarter. Few courses are available.

(14) Open enrollment: Class registration for which no appointments are necessary. Registration occurs on a first-come first-serve basis. Open enrollment occurs any time during the registration period for applicants or students who wish to register for evening, Saturday, or continuing education courses. It occurs during late registration for applicants or students who wish to register for daytime credit courses.

(15) GED: The General Educational Development test of the American Council on Education.

#### NEW SECTION

WAC 132I-160-025 **ADMISSION POLICY.** Highline Community College will admit applicants who:

(1) Are competent to profit from the college's courses; and

(2) Would not by their presence or conduct create a disruptive atmosphere within the college; and

(3) Are at least eighteen years old, or who have an approved high school diploma or GED certificate, or who are juniors or seniors in high school with college level academic skills and who have the written permission of the principal of the high school the applicant attends; provided that such admission is not inconsistent with the best interests of the applicant, other students, or the orderly operation of the community college, public or private secondary schools, or other institutions of higher education.

#### NEW SECTION

WAC 132I-160-031 **ADMISSION POLICY FOR APPLICANTS WHO ARE NOT ABLE TO DEMONSTRATE THEY ARE COMPETENT TO PROFIT FROM THE COLLEGE'S COURSES.** Applicants, regardless of age, who have either a high school diploma or a GED credential are assumed to be competent to profit from the college's courses. Applicants who are eighteen years old or older without a high school diploma or GED credential are provisionally admitted in keeping with the open door policy. However, these students may not necessarily be competent to profit from the college's courses. Therefore, these students are considered not regularly admitted students.

Provisional admission for these not regularly admitted students may be revoked if prior school records or professional testing or evaluation determines that the student is not competent to profit from the college's courses. The college may request such information on an as-needed basis. A review committee consisting of the director of admissions, a professional counselor, and the

section 504 compliance officer shall review such documentation and make any determination of revocation.

#### NEW SECTION

WAC 132I-160-032 **ADMISSION POLICY FOR APPLICANTS WHO ARE CURRENTLY ENROLLED IN A COMMON SCHOOL DISTRICT OR PRIVATE HIGH SCHOOL.** Highline Community College admits applicants who are concurrently enrolled in a common school district or accredited private school and Highline Community College. These applicants must meet the requirements in WAC 132I-160-045.

#### NEW SECTION

WAC 132I-160-033 **ADMISSION REQUIREMENTS.** There are some requirements in addition to the general admission policy (WAC 132I-160-025). These are:

(1) Highline does not require specific test scores for admission to the college. However, assessment for advising, placement, and retention is required for all new students with less than forty-five transferable college-level credits and for entry into selected courses and programs. The college uses the ASSET system for this purpose. It is given at frequent intervals in the Highline Community College testing center.

(2) The following programs have special admission requirements and procedures: Dental Assistant, Diving Technician, Medical Assistant, Registered Nursing, Respiratory Care, GED, and High School. These programs have specific selection procedures due to limited space or special requirements. The requirements and procedures differ for each program. They are updated annually. Contact the Highline Community College office of admissions, for specific information.

#### NEW SECTION

WAC 132I-160-035 **ADMISSION PROCEDURES.** Applicants can become newly admitted students in two ways: Formal and informal. Both methods require applicants to meet the policy listed in WAC 132I-160-025 and the requirements listed in WAC 132I-160-033. The formal method is used for applicants who wish to register for daytime credit courses and who want the earliest possible registration appointment. The informal method is used by applicants who wish to register for evening or Saturday credit courses. The informal method is also used by all applicants during late registration. Persons granted admission by either process are newly admitted students.

(1) These are the formal application procedures:

(a) Complete and return either a state of Washington uniform community college application form or a Highline Community College application form to the admission office. These forms are available at any community college and at most high schools. Contact the admission office at Highline Community College to request an application form. There is no admission fee.

(b) Highline does not require transcripts from other colleges or high schools for admission to the college. Admission to some special programs requires transcripts.

Students who wish to transfer credit from other accredited institutions to Highline should have official transcripts mailed to the registration office. Students wishing transcript evaluations must also complete a transcript evaluation request form which is available from the registration office. The registration office will notify students in writing of the evaluation. Transcript evaluation is a service and is not required for admission to the college.

(c) Falsification of documents for admission may result in disciplinary, civil, or criminal proceedings.

(2) These are the informal application procedures:

(a) Register for any credit course during open enrollment. No appointment is necessary during open enrollment. No application form is required. There is no admission fee.

(b) Highline does not require transcripts from other colleges or high schools for admission to the college. Admission to some special programs requires transcripts. Students who wish to transfer credit from other accredited institutions to Highline should have official transcripts mailed to the registration office. Students wishing transcript evaluations must complete a transcript evaluation request form which is available from the registration office. The registration office will notify students in writing of the evaluation. Transcript evaluation is a service and is not required for admission to the college.

(c) Falsification of documents for admission may result in disciplinary, civil, or criminal proceedings.

#### NEW SECTION

WAC 132I-160-045 ADMISSION REQUIREMENTS FOR APPLICANTS WHO ARE CURRENTLY ENROLLED IN A COMMON SCHOOL DISTRICT OR PRIVATE HIGH SCHOOL. Applicants who are currently enrolled in a common school district or accredited private school and Highline Community College must meet the following requirements:

(1) Applicants must be currently enrolled as juniors or seniors in a common school district or accredited private school. Students enrolled in a home school are not eligible for admission.

(2) Applicants must take the entire ASSET assessment process and score at college level.

(3) Applicants must not be on academic or disciplinary warning, probation, suspension, or dismissal status in their high school.

(4) Applicants must have permission from their high school principal; applicants under the age of eighteen must also have permission of a parent or legal guardian.

#### NEW SECTION

WAC 132I-160-047 ADMISSION PROCEDURES FOR APPLICANTS WHO ARE CURRENTLY ENROLLED IN A COMMON SCHOOL DISTRICT OR PRIVATE HIGH SCHOOL. Applicants who are currently enrolled in a common school district or accredited private school and Highline Community College must perform the following procedures:

(1) Demonstrate college level skills on the ASSET placement test.

(2) Submit an official "authorization to register." This form is available from Federal Way, South Central, and Highline high schools and the admission office of Highline Community College.

(3) The authorization to register form must have the signature of the high school principal, a college curriculum adviser, and, for students under the age of eighteen, a parent or legal guardian.

(4) Pay for tuition, books, fees, and supplies.

(5) Enroll only during open enrollment.

(6) Enroll only in college level courses (numbered 100 or above). The college may limit access to some college level courses for these students.

#### AMENDATORY SECTION (Amending Order 013, filed 1/6/76)

WAC 132I-160-060 RESIDENCY. (~~Tuition/matriculation fees are determined by Washington state resident/nonresident status as outlined by chapter 28B-15 RCW. A resident is defined as a person who can provide evidence of being domiciled in the state of Washington for one year prior to the beginning of the term for which he registered. Regardless of the above criteria, any person employed not less than 20 hours per week at any institution of higher education within the state of Washington and the children and spouses of such persons, federal employees in the state of Washington and their children and spouses, military personnel and their children and spouses residing or stationed in the state of Washington (unless stationed on a temporary basis for the purpose of reassignment or discharge processing) and all veteran residents whose first permanent duty option was in Washington state and who are receiving federal vocational or educational benefits as a result of military service, are eligible for resident tuition status.~~)

~~A minor's domicile is that of his parents. Determination of resident or nonresident status rests with the office of the registrar. Appeals of this determination may be made by submitting a written request of appeal to the office of the registrar. Written notification of receipt of such a request will be mailed to the requesting student and the materials will be reviewed by the registrar with advice from the office of the attorney general of the state of Washington. The results of the decision based upon this review shall be sent to the requesting student.)~~ Students who meet the definition of resident students according to RCW 28B.15.012(2) shall be classified as resident students. Students not eligible for residency classification will be classified as nonresident students. A copy of the Revised Code of Washington is available in the Highline Community College library.

Students who have questions about their classification must complete a residency questionnaire and submit the necessary documentation to the registrar. This questionnaire is available in the registration office. The registrar will review the questionnaire and will notify the student in writing of the decision within one week. Appeals of the decision of the registrar are referred by the registrar to the office of the attorney general. A written response is generally available to the student within thirty days.



Students are responsible for registering under the proper residency classification. Students who are not sure of their residency status should fill out and then submit a completed residency questionnaire to the registrar.

#### NEW SECTION

WAC 132I-160-065 REGISTRATION PROCEDURES. There are two categories of registration procedures. One category applies only to daytime credit courses while the other category applies to evening and Saturday credit courses and all continuing education courses. In both cases, registration is not completed until the student completes and submits all registration material, pays in full for all tuition and fees, and has all these items accepted by the registration office.

(1) Daytime credit courses. The college prints the schedule of dates and times to register in "The Quarterly," which is Highline Community College's quarterly schedule of course offerings. One to two weeks before the start of registration, "The Quarterly" is available on campus in Building 6 and by mail. The registration office schedules currently enrolled, former, and newly admitted students, in that order, into three sets of registration appointments according to these rules:

(a) Currently enrolled students are assigned the first set of registration appointments on the basis of the number of credits earned at Highline Community College. Students with the highest number of earned credits are assigned the first block of appointments. Subsequent blocks of appointments are assigned on the basis of descending number of credits. Appointments are by date and students may register at any time on or after that date. Appointment dates are only found in registration appointment books located in the registration area, faculty buildings, the library, the Federal Way center, and the advising resource center. Appointment dates are listed by name. These appointment books are available two weeks before registration begins.

(b) Former students are assigned a date to register after currently enrolled student appointments. This date is announced in "The Quarterly." Former students may register any time on or after this date.

(c) Newly admitted students who complete the formal application process described in WAC 132I-160-030 are assigned the last set of appointments. The admissions office will notify these students by mail of their specific appointment time and date. Newly admitted students may register at their scheduled date and time, may re-schedule with the admissions office for a later appointment, or may register during late registration.

(d) Late registration occurs after the period of appointments. It is a period of open enrollment. Fewer courses are available during this period. Students register without appointments. Any student eligible for admission (WAC 132I-160-030) may register during late registration. Mail-in registration is accepted during this period. Forms for mail-in registration are in "The Quarterly." Telephone registration is accepted during specific time periods only. These time periods are listed in "The Quarterly."

(2) Evening and Saturday credit courses and continuing education courses. Any student and any applicant eligible for admission (WAC 132I-160-030) may register for evening, Saturday, and continuing education courses at any time during the registration period without an appointment. Mail-in registration is accepted during this period. Forms for mail-in registration are in "The Quarterly." Telephone registration is accepted during specific time periods only. These time periods are listed in "The Quarterly."

#### AMENDATORY SECTION (Amending Order 013, filed 1/6/76)

WAC 132I-160-090 CHANGES IN REGISTRATION. (1) Changes in schedule: (~~Classes or sections may be changed during specific days and times during the first week of the quarter. These dates and times are published in the college calendar, official college schedule, and the daily bulletin. A change is not official until it has been processed through the registrar's office. Approval of an advisor or a counselor or by the instructor, while not required, is recommended.~~) Students may change their course schedule after initial registration. Deadlines for changes are announced in "The Quarterly." Submit the change of schedule (add/drop) form to the registration office. Instructors' signatures are required after the first week of the quarter. This form is available in the registration area and educational planning center. Students may wish to talk with an advisor first.

(2) Dropping a (~~class. A class may be dropped for a good cause. Any class dropped during the first three weeks of a quarter will not be recorded on a student's official transcript. For classes dropped later in the quarter, the student will be given a "W" for passing work or an "E" for failing work as determined by the instructor, based on his or her status in that class at the time the student drops that class. To drop a class and retain good academic standing at Highline or for transfer to another college at a later date, the student must follow the proper procedure as outlined on the "change of schedule request" form available from an adviser, the counseling center, or the office of registrar, which is as follows: During the first week of the quarter only the student's signature is required; student and instructor's signature required thereafter. The instructor of the class being dropped must be consulted. Consultation with an adviser or counselor is also recommended. No course withdrawals are permitted within the last two weeks of a quarter.~~) course: Students may drop courses until the end of the ninth week of the quarter (except during summer). Instructors' signatures are required after the first week of the quarter. Classes dropped during the first three weeks of the quarter will not appear on student transcripts. Instructors have the option of assigning either a withdrawal grade (W) or, if the student is performing failing work at the time of withdrawal, a failing grade (0.0) to students who withdraw from a course after the third week of the quarter. Students may wish to talk with an adviser first. Check "The Quarterly" for the deadline to drop (withdraw) from courses.



(3) ~~Withdrawal from college: ((Regulations about withdrawal from courses apply to withdrawal from the college. A student who wishes to withdraw from college altogether uses the same procedure as for dropping a class. The first step is to report to an adviser to initiate the withdrawal procedure. An official withdrawal from the college is granted only after all the forms are completed and accepted by the registrar's office. For a complete withdrawal from the college the signature of the instructor of each class, the adviser/counselor and student is required on the "change of schedule request" form at all times. No official withdrawals are permitted within the last two weeks of a quarter. Exceptions in these procedures may be made if withdrawal is requested by the college or is [if] there are extenuating circumstances. Determination of such exceptions rests with the registrar's office.~~

~~(4) A withdrawal or change in registration is official when it is filed on the proper form (available through the counseling center and/or the office of admissions and/or the office of the registrar), signed by a counselor or adviser (and course instructor if applicable), and accepted in the registrar's office.)) Students who wish to withdraw from Highline Community College use the same procedures as for dropping a course. The signature of the instructor of each course is required on the change of schedule (add/drop) form after the first week of the quarter. Students who do not officially withdraw and simply cease to attend courses may be assumed by the instructor to have not met minimum course requirements and therefore may be graded as having failed (0.0) the course.~~

AMENDATORY SECTION (Amending Order 013, filed 1/6/76)

~~WAC 132I-160-100 FEES. (((1) A nonrefundable \$10.00 application fee is payable upon application and is mandatory regardless of student status being sought.~~

~~(2) All matriculation fees are based on the residency/nonresidency requirements of these policies (WAC 132I-160-060) and upon chapter 28B.15 RCW and 1972 supplement, Title 28B RCW. Payment of a nonrefundable \$10.00 "registration deposit" is permissible to hold open a space for an applicant in order to allow more time to obtain full tuition fees.~~

~~(3) Special quarterly fees:~~

~~(a) Parking: Students with on-campus parking must pay a parking fee. On-campus parking rates vary according to the number of credit hours. Specific delineation of on-campus parking fees may be found in chapter 132I-116 WAC Parking and traffic rules and regulations, and are normally displayed at the office of registration.~~

~~(b) Some courses may have special additional fees as listed in the official class schedule. These fees are established by the board of trustees and are listed on "special instructional fees" which is available through the office of the registrar.~~

~~(c) There are various testing services available at Highline Community College each with a fee structure~~

~~dependent upon the type of testing involved. A list of available tests and their individual costs may be obtained through the counseling center on campus.~~

~~(d) Some laboratory courses may assess a breakage fee which is dependent upon the type of equipment/course.~~

~~(4) A nonrefundable graduation fee of \$10.00 (or \$15.00 for concurrence degree awards) is due by March 15 of the graduation year. Such fees are transferable if graduation must be postponed.~~

~~(5) Processing fees: No processing fee will be charged for registration changes initiated by the college or for students wishing to add credits. Other changes in registration, resulting either in an equal or reduced course load will result in a \$2.00 process charge as will all other noncollege initiated changes after the third week of any quarter.~~

~~(6) A complete explanation of the basis of these fees may be obtained under "tuition and fees" section of the general catalog.)) (1) Tuition and fees are based on residency requirements (WAC 132I-160-060) and upon chapter 28B.15 RCW, College and university fees. Tuition and fees are set by the Washington state legislature and are subject to change. The current tuition and fee schedule is available in "The Quarterly."~~

~~(2) Special quarterly fees:~~

~~(a) Parking: Students who park on-campus must pay a parking fee. On-campus parking rates vary according to the number of credit hours. Information about on-campus parking fees, traffic rules and regulations is available at the campus Security Office, Building 6, 878-3710, extension 218.~~

~~(b) Some courses may have additional fees as listed in the official quarterly course schedule. These fees are established by the board of trustees and are listed as "special instructional fees." Further information is available through the registration office.~~

~~(c) Some testing services charge a fee. A list of these services and fees may be obtained from the testing center.~~

~~(d) Some laboratory courses may assess a breakage fee.~~

~~(e) Processing fees: No processing fee will be charged for registration changes initiated by the college or for students wishing to add credits. Changes resulting in a reduced number of credits will be charged a two-dollar processing fee. All changes after the end of the third week of the quarter will result in a two-dollar processing fee. There is no charge for a complete withdrawal.~~

~~(f) An explanation of fees may be obtained under the "Quarterly Tuition and Fee Schedule" section of the Highline Community College catalog.~~

AMENDATORY SECTION (Amending Order 013, filed 1/6/76)

~~WAC 132I-160-110 REFUNDS. (((1) Classifications: Fees are refundable under the following contingencies:~~

~~(a) Complete withdrawal from all classes prior to the end of the third class week of the quarter.~~

~~(b) Change in registration resulting in a reduction of two or more credits below the total credits on which tuition and fees were determined, but no refund after the third class week.~~

~~(2) Exceptions. Only three fees are designated as strictly nonrefundable: Application, registration deposit, and graduation fees. (WAC 132I-160-030, 132I-160-100)~~

~~(3) Deductions. Refunds are subject to two types of deduction: If the total of tuition and fees paid at registration is \$30.00 or more, a fee of \$10.00 will be deducted; if the total is less than \$30.00, a fee of \$5.00 will be deducted.~~

~~After the \$10.00 or \$5.00 is deducted, the remainder of tuition and fees previously paid by the student will be subject to the following schedule of refunds:~~

~~Before the start of the first day of the academic quarter = 100% refund.~~

~~Before the end of the first week of the academic quarter = 80% refund.~~

~~Before the end of the third week of the academic quarter = 50% refund.~~

~~After the end of the third class week = no refund.~~

~~(4) Military service. Students who are forced to withdraw from all college work by being involuntarily called into military service or a reserve unit being called to active duty, are eligible for a letter issued by the registrar's office which will credit tuition paid for the current quarter to a quarter when the student is able to resume his college work with Highline Community College.) Refunds resulting from official withdrawal from courses will be computed as follows for state supported courses:~~

~~(1) One hundred percent. The refund will be one hundred percent of the amount paid if an official withdrawal form is received in registration or at the Highline College Federal Way center before the close of business on the fifth calendar day of the quarter. The deadlines vary for summer quarter courses, late-starting courses, or short courses. Deadlines are published in "The Quarterly."~~

~~(2) Cancelled courses. When Highline Community College cancels a course, Highline will refund the total amount paid for the course unless the student enrolls in a course to replace the cancelled course. If the new course is for fewer credits, Highline will refund the difference.~~

~~(3) Fifty percent. Highline Community College will refund fifty percent of the total amount paid if an official withdrawal form is received in the registration office or at the Highline Community College Federal Way center after the fifth calendar day, but before the close of business on the 30th calendar day of the quarter. The deadlines vary for summer quarter courses, late-starting courses, or short courses. Deadlines are published in "The Quarterly."~~

~~(4) Summer quarter, late starting, and short courses. Refunds for these courses will be determined by the registrar.~~

~~(5) Continuing education classes. To obtain refunds for self-support courses, withdrawals must be received~~

forty-eight hours before the first scheduled course meeting. Other refunds, except for course cancellation, will be made at the discretion of the director of continuing education.

(6) There is no refund of the twenty-five dollars non-refundable fall quarter registration deposit to students who did not pay the total amount of their tuition and fees before the deadline. This deadline is published in "The Quarterly."

NEW SECTION

WAC 132I-160-120 APPEALS. Students have the right to appeal admission and registration decisions. Students are entitled to two levels of appeal. All appeals must be in writing. Admission decisions are appealed at the first level to the director of admissions and at the second level to the dean of students. Registration decisions are appealed at the first level to the registrar and at the second level to the dean of administration. The student must initiate an appeal at the first level. If the student is not satisfied with the decision at the first level, the student may appeal at the second level. The results of a second level appeal are final. Students may expect a written response to an appeal within ten working days.

REPEALER

The following sections of the Washington Administrative Code are repealed:

WAC 132I-160-030 BASIC POLICY OF ADMISSIONS.

WAC 132I-160-040 NONMATRICULANT POLICY OF ADMISSIONS.

WAC 132I-160-050 ADDITIONAL ADMISSIONS PROCEDURES FOR SPECIAL PROGRAMS.

WAC 132I-160-070 APPOINTMENTS TO REGISTER.

WAC 132I-160-080 REGISTRATION.

REPEALER

The following chapter of the Washington Administrative Code is repealed:

WAC 132I-168-010 ACCESS TO PUBLIC RECORDS.

WAC 132I-168-020 PURPOSE.

WAC 132I-168-030 REQUEST FOR DOCUMENTS—PROCEDURE.

WAC 132I-168-040 APPEAL.

WAC 132I-168-050 EXEMPTIONS.

WAC 132I-168-060 COPYING.

WAC 132I-168-070 PROTEST.

WAC 132I-168-080 OFFICE HOURS.

WAC 132I-168-090 SANCTIONS.

WAC 132I-168-100 PUBLIC RECORDS FORM

1. WAC 132I-168-110 PUBLIC RECORDS FORM

2.

AMENDATORY SECTION (Amending Order 012, filed 10/31/75)

## WAC 132I-168A-030 DEFINITION OF TERMS.

(1) Circulating material: Materials designated as available for library patrons to check out.

(2) Circulation period: The length of time materials may be checked out of the library. The time period varies with material's classification.

(3) Holds: A ~~((library patron wishing to check out circulating material already checked out may))~~ request that material be held for ~~((his/her use when returned))~~ a specific library patron's use when returned to the circulation desk.

(4) Library day: A library day is constituted by each day the library is open to the public.

(5) Library hours: A library hour is constituted by each hour the library is open to the public.

(6) Noncirculating materials: Materials designated ~~((as))~~ not available for library patrons to check out. Rare exceptions may be authorized by a librarian.

(7) Recalls: A request for a patron to return circulating materials under conditions prescribed in WAC ~~((132I-168-070 [codified as WAC 132I-168A-070], the library may request a patron to return circulating materials))~~ 132I-276-070.

(8) Reserve material: Materials placed under specially supervised circulation at special request of a Highline instructor.

(9) Search: A patron may request the library to make special efforts to locate a particular piece of library material.

AMENDATORY SECTION (Amending Order 012, filed 10/31/75)

WAC 132I-168A-090 SCHEDULE OF FINES AND CHARGES. (1) Fines. The schedule of fines and charges is posted at the circulation desk and is available through the office of the director of the library. All patrons are subject to uniform application of this schedule. There are no fines levied for overdue materials that are in regular circulation. Fines are charged for overdue reserve, overnight, reference and special collections materials as follows:

(a) For materials under two to twenty-four hour circulation, fines are levied at a rate of \$.25/library hour ~~((see WAC 132I-168-020) [codified as WAC 132I-168A-020]))~~ up through the first four hours inclusive and \$.10/library hour thereafter.

(b) For materials under three-day loan, fines are levied at a rate of \$.50/library day ~~((see WAC 132I-168-020) [codified as WAC 132I-168A-020]))~~.

(c) For periodicals, fines are levied at a rate of \$.25/library day per item up to a maximum of \$2.00.

(2) Damage and replacement charges.

(a) Damage charges for all library materials, regardless of classification, will reflect the cost of repair but will not exceed the cost of replacement. Damages to special collection materials will be determined by the director of the library or his delegate. Charges for damaged reprints reflect the current copy-machine rates.

(b) Replacement charges are \$2.00 over the current list price of the lost or missing item. This rate for replacement applies to all library materials except:

(i) Vertical file materials which are assessed at \$2.00 per item;

(ii) Special collection materials which are assessed as determined by the director of the library or his delegate, and;

(iii) Periodical materials which are assessed at \$2.00 above the current list price for each periodical in addition to which bound periodicals will have an additional charge levied to reflect the cost of replacement and the cost of binding in volumes.

(3) Notification of overdue materials ~~((held against the student's record))~~ will be by mail to the address listed on the book card, registration roster or in the office of the registrar. Notice of materials placed on reserve may be by telephone and/or by mail. Responsibility for correct address information lies with the patron exclusively.

(4) Anyone owing over a total of \$50.00 in fines, damages and/or replacement charges shall have library privileges withheld as notified, in writing, by the director of the library or his delegate.

(5) Failure to return library materials and/or to settle disputes concerning fines, damages or replacement fees by the end of the quarter during which the material was circulated or the fine or fee was incurred may result in having library privileges suspended until the dispute is satisfactorily settled.

(6) Fines accrue from the first day or hour such materials are overdue.

(7) Failure to accommodate a library hold or recall effort may result in fines or similar appropriate disciplines.

(8) College employees who are terminating their employment at Highline Community College may have outstanding fines and/or charges deducted from final paychecks or may have final paychecks withheld until charges are paid.

AMENDATORY SECTION (Amending Order 012, filed 10/31/75)

WAC 132I-168A-100 APPEALS OF FINES AND CHARGES. (1) Library patrons wishing to appeal fines and/or charges assessed by the library may do so by completing library forms found at the circulation desk. Completed forms are to be filed with a librarian at the circulation desk. Failure to file this form within ~~((ten))~~ twenty library days of the assessment of the fine or charge in question or within ~~((ten))~~ twenty days of the time the library patron was made aware of the fine or should have been aware of the fine shall be deemed a waiver of the right to appeal.

(2) ~~((Within three library days of filing an appeal form, the director of the library or his designee shall respond, in writing, specifically stating the proposed disposition of the appeal. This response shall be sent to the address listed on the appeal form.))~~ Upon receipt of a properly filed request for a brief adjudicative proceeding, the librarian shall conduct a hearing. Within ten days of such hearing, the librarian shall serve the patron with an

initial order either upholding or denying the patron's appeal. Such order shall comply with the requirements of RCW 34.05.485 and WAC 10-08-210.

(3) If the ~~((proposed disposition))~~ initial order is ~~((stiff))~~ considered unsatisfactory, the library patron may ~~((request a meeting))~~ file an appeal with the ~~((director of the library))~~ appropriate dean or his or her designee. Such request shall be made in writing, shall clearly state the grounds for the appeal, and shall be postmarked within ~~((ten))~~ twenty-one days of the ~~((time the patron received the response to the appeal or should have received the response))~~ date of service of the initial order. Failure to file this request within ~~((the ten))~~ twenty-one library days shall be deemed as acceptance of the disposition proposed by the director.

(4) The ~~((director, upon receipt of a request for a meeting, shall establish a meeting time, within the library day, and a meeting place, within the library. The time of this meeting shall be not less than five days nor later than 20 days after the receipt of the request. The director shall send notice of the meeting time and place to the address listed on the appeal form))~~ dean's decision shall be final.

~~((5) If the library patron is not satisfied with the resolution of fine and/or charge after meeting with the director, the patron may request an administrative review of the decision. Such request must be made in writing, sent to the director of the library, and postmarked not later than 10 days after meeting with the director. Failure to file this request within the 10 days shall be deemed a waiver of the right for administrative review or other review as specified in this section.~~

~~(6) Within five days, the college president or vice president shall respond, in writing, to the request for administrative appeal. This response shall specifically state the proposed disposition of the appeal. The response shall be sent to the address listed on the appeal form.~~

~~(7) If the library patron is not satisfied with the proposed disposition of the fines and/or charges, the patron may request a meeting with the college president and vice president. Such request shall be made in writing, shall be sent to the director of the library, and shall be postmarked within 10 days of the time the patron received, or should have received, the response from the administrative review. Failure to file this request within 10 days shall be deemed as acceptance of the proposed response from the administrative appeal.~~

~~(8) The college president and/or vice president, upon receipt of request for a meeting, shall establish a meeting time, within a library day, and a meeting place on campus. The time of this meeting shall be not less than 10 days nor later than 20 days after the receipt of the request.~~

~~(9) If the library patron is not satisfied with the resolution after meeting with the president and/or vice president, the patron may request to be heard by the board of trustees. The procedures for requesting this meeting are set forth in the bylaws of the board of trustees (chapter 1321-104 WAC):~~

## REPEALER

The following section of the Washington Administrative Code is repealed:

WAC 1321-168A-020 BASIS OF POLICIES AND PROCEDURES.

## Chapter 1321-276 WAC ACCESS TO PUBLIC RECORDS

### NEW SECTION

WAC 1321-276-010 ACCESS TO PUBLIC RECORDS. This chapter shall be known as Highline Community College rules on public records.

### NEW SECTION

WAC 1321-276-015 RECORDS INDEX. A records index of all documents as required by law shall be maintained by the college.

### NEW SECTION

WAC 1321-276-020 PURPOSE. The purpose of this chapter is to ensure compliance by Highline Community College with chapter 42.17 RCW while at the same time preserving the orderly operation of the community college district and the privacy of the students and employees of the college.

### NEW SECTION

WAC 1321-276-030 REQUEST FOR DOCUMENTS—PROCEDURE. (1) All documents which are public records as defined by chapter 42.17 RCW are presumptively available for public access, except as restricted by WAC 1321-276-050. Any person wishing to inspect a public record shall submit Form 1, described in WAC 1321-276-100. Each request must be presented to the records officer, or to his secretary during regular office hours of the college, as defined in WAC 1321-276-080.

(2) The records officer shall, by the close of that business day, if the request is presented before noon, or noon the following business day if the request is presented in the afternoon:

- (a) Make the requested document available; or
- (b) State that such a document does not exist; or
- (c) Ask for clarification of the document requested; or
- (d) Deny access because the document is exempt from public inspection under WAC 1321-168-050.

The action taken shall be marked on Form 1 and returned to the person submitting the form.

(3) The registrar is hereby designated as the records officer.

### NEW SECTION

WAC 1321-276-045 REVIEW OF DENIALS OF PUBLIC RECORDS REQUEST. (1) Any person who objects to the denial of a request for a public record may petition for prompt review of such decision by filing Form 2 (WAC 1321-276-110), together with Form 1 as returned.

(2) The written request (Forms 1 & 2) by a person demanding prompt review of a decision denying a public record shall be submitted to the president or his designee.

(3) Within two business days after receiving the written request by a person petitioning for prompt review of a decision denying a public record, the president or his or her designee, shall complete such review.

(4) During the course of the review the president or his or her designee shall consider the obligations of the district to fully comply with the intent of chapter 42.17 RCW insofar which requires providing full public access to official records, but shall also consider both the exemptions provided in RCW 42.17.310 and the provisions of the statute which require the district to protect public records from damage or disorganization, prevent excessive interference with essential functions of the agency, and prevent any unreasonable invasion of personal privacy by deleting identifying details.

NEW SECTION

WAC 132I-276-050 EXEMPTIONS. (1) Public access to documents exempt under RCW 42.17.310 or exempted from disclosure by other state or federal law shall not be granted, unless the records officer determines that disclosure would not affect any vital governmental interest. If the interest can be protected by deletion of person references, access shall be granted following deletion of such material, and a reasonable time shall be allowed for deleting the material.

(2) Individual files on students of Highline Community College shall be available for inspection only as described by chapter 132I-280 WAC. The only information contained in the individual file of an employee shall be the name, status, salary, and teaching duties of the employee. The employee, however, shall have full access to his/her personnel file.

NEW SECTION

WAC 132I-276-060 COPYING. Persons granted access to public records pursuant to Form 1 shall be allowed to copy such documents on a designated copier of Highline Community College on payment of fifty cents per copy. The registrar will designate the copier and inspect the copies and records after the copying is completed. Payment shall be made to a cashier of the college who will issue a receipt which must be presented to the person in charge of the copying machine. The charge of fifty cents per copy is the reasonable cost of paper and copying charges for Highline Community College.

NEW SECTION

WAC 132I-276-070 PROTEST. Any employee or individual who believes a document has been or is about to be released, and, who believes his or her right to privacy will be infringed by public inspection of the document may file a protest with the president. If after consideration of the request for inspection and the protest, the president believes inspection should be denied, he or

she should take appropriate action, including, if appropriate, the filing of a Section 33 request for an injunction.

NEW SECTION

WAC 132I-276-080 OFFICE HOURS. For purposes of this chapter, the regular office hours of Highline Community College shall be considered 9:00 a.m. through 4:00 p.m., Monday through Friday; except for legal holidays for state employees.

NEW SECTION

WAC 132I-276-090 SANCTIONS. In accordance with RCW 42.17.290, if a person granted access to public records pursuant to this chapter destroys, mutilates, or fails to return such documents, or who returns the documents in an unreasonably disorganized fashion, then the president may order that an adjudicative proceeding as defined in chapter 34.05 RCW be conducted to determine if sanctions should be levied against such person.

Any sanctions imposed under this provision shall be strictly limited to protecting public records and in no way shall they be imposed so as to violate the college's duty to comply with chapter 42.17 RCW.

Any sanctions imposed under this section may be appealed to the president. The president shall review the record of the proceedings which give rise to the appeal.

The appeal must be in writing and must clearly state errors in fact or matters in extenuation or mitigation which justify the appeal. The appeal must be filed within twenty-one days from the date of service of the initial order. The president's determination shall be final. If a student or employee of the district willfully destroys or mutilates records of the district, he/she may be subject to disciplinary proceedings pursuant to the student code of rights and responsibilities, or to the relevant rules and regulations of the district pertaining to faculty and classified staff.

NEW SECTION

WAC 132I-276-100 PUBLIC RECORDS FORM 1.

Community College District IX  
Public Records Form 1

To: .....

The applicant requests inspection of the following documents:

- 1. ....
- 2. ....
- 3. ....

The applicant agrees to return the documents unharmed and in an orderly fashion.

Signed .....  
Address .....

This form must be presented to the records officer or their secretary.

Disposition:

- ..... The requested document is available for inspection.
- ..... The college is not in possession of such a document.
- ..... Please clarify precisely what documents are being requested as it cannot be determined from your application what documents are desired.
- ..... The requested is denied because the document is:
  - ..... (a) Personal information in a file maintained for a student of this institution.
  - ..... (b) Personal information in a file maintained for an employee of the district disclosure of which would violate the employee's right to privacy.
  - ..... (c) A preliminary draft, note, recommendation, or interagency memorandum in which opinions are expressed or policies formulated or recommended, which document has not been publicly cited by this agency in connection with an agency action.
  - ..... (d) A record which is relevant to a controversy to which this agency is a party which record would not be available to another party under the rules of pretrial discovery.
  - ..... (e) The document contains personal information which, when deleted, can be released, and such deletions will be completed by .....
  - ..... (f) Other.

.....  
 .....

Signed .....  
 Title .....

A refusal to make a record available for inspection may be appealed to the president.

Received: .....  
 Returned: .....  
 Demand: .....

NEW SECTION

WAC 132I-276-110 PUBLIC RECORDS FORM 2.  
 Community College District IX  
 Public Records Form 2

To: .....

The applicant has been denied inspection of a document which is possessed by Community College District IX. The denial was made following submission of Form 1 (attached hereto).

The applicant appeals the disposition made on Form 1 and requests you to review this denial prior to the close of the second business day following the denial of the request.

Signed .....  
 Address .....

This form must be presented to the secretary of the president. The appellant understands the president is not available until ....., and agrees to an extension of the return until .....

Signed .....

Disposition:

- ..... Inspection of the documents is granted.
- ..... Inspection will be granted following deletion of personal material in the requested documents.
- ..... Inspection of the documents is denied because

\_\_\_\_\_  
 Signed .....  
 Title .....

Received: .....  
 Returned: .....  
 Demand: .....

Chapter 132I-280 WAC  
 FAMILY EDUCATIONAL RIGHTS AND PRIVACY ACT OF 1974

NEW SECTION

WAC 132I-280-010 CONFIDENTIALITY OF STUDENT RECORDS. The college continually receives requests from outside sources for information about students, both past and present. The staff and faculty of the college are reminded that 20 U.S.C 1232(g) the Family Educational Rights and Privacy Act of 1974 directs the college to adopt a policy on student education records to insure that information contained in such records is treated in a responsible manner with due regard to the personal nature of the information contained in those records. In order to prevent embarrassment or possible legal involvement of the college and its employees because of improper disclosure of information, it is important that college policy be implemented in the release of such information.

NEW SECTION

WAC 132I-280-015 DEFINITION OF A STUDENT. A student is defined as any person who is or has been officially registered at Highline Community College and with respect to whom the college maintains education records or personally identifiable information.

NEW SECTION

WAC 132I-280-020 EDUCATION RECORDS—STUDENT'S RIGHT TO INSPECT. (1) A student has

the right to inspect and review his or her education records.

(a) For purposes of this section the term "education records" means those records, files, documents, and other materials which contain information directly related to a student.

(b) The term "education records" does not include:

(i) Records of instructional, supervisory, and administrative personnel which exist solely for the use of the maker and which are not accessible or revealed to any other person except a substitute.

(ii) In the case of persons who are employed by an educational institution but who are not attending that institution, records made and maintained in the normal course of business which relate exclusively to such person in that person's capacity as an employee and are not available for any other use.

(iii) Records on a student which are created or maintained by a physician, psychiatrist, psychologist, or other recognized professional or paraprofessional capacity, or assisting in that capacity and which are created, maintained, or used only in connection with the treatment of the student, and are not available to anyone other than persons providing such treatment; provided, however, that such records can be personally reviewed by a physician or other appropriate professional of the student's choice.

(2)(a) Recommendations, evaluations, or comments concerning a student that are provided in confidence, either expressed or implied, as between the author and the recipient, shall be made available to the student, except as provided in (b), (c), and (d) of this subsection.

(b) The student may specifically release his right to review where the information consists only of confidential recommendations respecting:

(i) Admission to any educational institution; or

(ii) An application for employment; or

(iii) Receipt of an hour or honorary recognition.

(c) A student's waiver of his or her right of access to confidential statements shall apply only if:

(i) The student is, upon request, notified of the names of all persons making confidential statements concerning him; and

(ii) Such confidential statements are used solely for the purpose for which they were originally intended; and

(iii) Such waivers are not required as a condition for admission to, receipt of financial aid form, or receipt of any other services or benefits from the college.

(d) Recommendations, evaluations, or comments concerning a student that have been provided in confidence, either expressed or implied, as between the author and the recipient, prior to January 1, 1975, shall not be subject to release under (a) of this subsection. Such records shall remain confidential and shall be released only with the consent of the author. Such records shall be used by the institution only for the purpose for which they were originally intended.

(3) Where requested records or data include information on more than one student, the student shall be entitled to receive or be informed of only that part of the record or data that pertains to the student.

(4) Students have the right to obtain copies of their educational records. Charges for the copies shall not exceed the cost normally charged by the college (except in cases where charges have previously been approved by the board of trustees action for certain specified services, such as transcripts and grade sheets).

(5) The college registrar is the official custodian of academic records and therefore is the only official who may issue a transcript of the student's official academic record.

(6) Student education records may be destroyed in accordance with a department's routine retention schedule. In no case will any record which is requested by a student for review in accordance with this section and WAC 132I-280-025 be removed or destroyed prior to providing the student access.

#### NEW SECTION

WAC 132I-280-025 REQUESTS AND APPEAL PROCEDURES. (1) A request by a student for review of information should be made in writing to the college individual or office having custody of the particular record.

(2) An individual or office must respond to a request for education records within a reasonable period of time, but in no case more than thirty days after the request has been made. A college individual or office which is unable to comply with a student's request within the above-stated time period shall inform the student of that fact and the reasons in writing.

(3)(a) A student who feels that his or her request has not been properly answered by a particular individual or office or who feels that the information contained in those records is incorrect should contact the appropriate dean responsible for the individual or office for mediation.

(b) In cases where a student remains dissatisfied after consulting with the appropriate dean the student may then request a hearing by the president or his or her designee(s). Following the hearing, the hearing officer shall render his or her decision within a reasonable period of time. In all cases the decision of the hearing officer shall be final.

(c) In no case shall any request for review by a student be considered by the college which has not been filed with that body in writing within ninety days from the date of the initial request to the custodian of the record.

(d) The college shall not review any matter regarding the appropriateness of official academic grades beyond that provided for in WAC 132I-120-427, et seq.

#### NEW SECTION

WAC 132I-280-030 RELEASE OF PERSONALLY IDENTIFIABLE RECORDS. (1) The college shall not permit access to or the release of education records or personally identifiable information contained therein, other than "directory information" without the written consent of the student, to any party other than the following:

(a) College staff, faculty, and students when officially appointed to a faculty council or administrative committee, when the information is required for a legitimate educational interest within the performance of their responsibilities to the college, with the understanding that its use will be strictly limited to the performance of those responsibilities.

(b) Federal and state officials requiring access to education records in connection with the audit and evaluation or a federally or state-supported education program or in connection with the enforcement of the federal or state legal requirements which relate to such programs. In such cases the information required shall be protected by the federal or state official in a manner which will not permit the personal identification of students and their parents to other than those officials and such personally identifiable data shall be destroyed when no longer needed for such audit, evaluation, or enforcement of legal requirements.

(c) Agencies or individuals requesting information in connection with a student's application for, or receipt of financial aid.

(d) Organizations conducting studies for or on behalf of the college for purposes of developing, validating, or administering predictive tests, administering student aid programs, and improving instruction, if such studies are conducted in such a manner as will not permit the personal identification of students by persons other than representatives of such organizations, and such information will be destroyed when no longer needed for the purposes for which it was provided.

(e) Accrediting organizations in order to carry out their accrediting functions.

(f) Any person or entity designated by judicial order or lawfully issued subpoena, upon condition that the student is notified of all such orders or subpoenas in advance of the compliance therewith. Any college individual(s) or office(s) receiving a subpoena or judicial order for education records shall immediately notify the assistant attorney general for the college before releasing the documents.

(2) Where the consent of a student is obtained for the release of education records, it shall be in writing, signed and dated by the person giving such consent, and shall include:

(a) A specification of the records to be released;

(b) The reasons for such release; and

(c) The names of the parties to whom such records will be released.

(3) In cases where records are made available without student release as permitted by subsection (1)(b), (c), (d), (e), and (f) of this section, the college shall maintain a record kept with the education record released which will indicate the parties which have requested or obtained access to a student's records maintained by the college and which will indicate the legitimate interest of the investigating party. Releases in accordance with subsection (1)(a) of this section need not be recorded.

(4) Personally identifiable education records released to third parties, with or without student consent, shall be accompanied by a written statement indicating that the

information cannot be subsequently released in a personally identifiable form to any other parties without obtaining consent of the student.

(5) The term "directory information" used in subsection (1) of this section is defined as a student's name, address, telephone number, dates of attendance, and degrees and awards received. Students may request that the college withhold directory information through written notice to the registration office.

(6) Information from education records may be released to appropriate persons in connection with an emergency if the knowledge of such information is necessary to protect the health or safety of a student or other person(s).

#### NEW SECTION

WAC 132I-280-035 COLLEGE RECORDS. All college individuals or offices having custody of education records will develop procedures in accord with WAC 132I-280-010 through 132I-280-040. Any supplementary regulations found necessary by departments will be filed with the college which will be responsible for periodic review of policy and procedures.

No records shall be kept that reflect a student's political or ideological beliefs or associations.

#### NEW SECTION

WAC 132I-280-040 REVIEW OF RECORDS REQUESTS AND REQUESTS TO AMEND. (1) The registrar shall be responsible for reviewing unusual requests for information and for assisting in the interpretation of these rules.

(2)(a) A student who believes that information contained in his or her educational records is inaccurate or misleading or violates his or her privacy may request that the college amend these records.

(b) The college shall decide within ten working days of a student's request to amend records whether or not it will amend those records.

(c) If the college decides to refuse to amend the educational records of the student according to his or her request, it shall so inform the student of the refusal and advise the student of the right to a hearing.

(d) The student feeling aggrieved by a denial of his or her request to amend educational records may file an appeal requesting a formal adjudicative proceeding before the president or their designee.

(e) If, at the conclusion of the hearing process, the college still declines to amend the student's educational records, the student may place a statement in his or her educational records explaining that he or she feels that the records are erroneous and setting out the reasons for this belief. This statement shall be retained as long as the disputed information is on file and shall be forwarded with this information any time it is disclosed to an outside agency.

Chapter 132I-300 WAC  
GRIEVANCE PROCEDURES—TITLE IX—  
HANDICAPPED



NEW SECTION**WAC 132I-300-010 STATEMENT OF POLICY.**

It is the policy of Highline Community College not to discriminate on the basis of sex, disability, sexual orientation, race, color, national origin, or age in admission and access to, or treatment or employment in its programs or activities as required by Title IX of the Educational Amendments of 1972, Section 504 of the Rehabilitation Act of 1973, Title VI of the Civil Rights Act of 1964, the Age Discriminating Act and their implementing regulations.

Sexual harassment is a form of sex discrimination. It occurs in a variety of situations which share a common element: The inappropriate introduction of sexual activities or comments into the work or learning situation, the creation of relationships of unequal power and/or elements of coercion, such as requests for sexual favors as a criterion for granting work, study, or grading benefits. Sexual harassment may also involve relationships among peers of repeated sexual advances or demeaning verbal behavior resulting in a harmful effect on a person's ability to study or work in the academic setting.

NEW SECTION**WAC 132I-300-020 DISCRIMINATION AND SEXUAL HARASSMENTS COMPLAINTS—PROCEDURE.**

(1) Any student or employee who believes that he or she has been the subject of discrimination or sexual harassment, should report the incident or incidents to one of the following college representatives: Title IX Officer, Coordinator of Health Services, Director of the Women's Programs, Director of Continuing Education. The college encourages the timely reporting of any incident(s) of discrimination or sexual harassment.

(2) All reports of incident(s) will be forwarded to the Title IX Officer for coordination and a determination on how to process the complaint.

(3) The Title IX Officer shall be an employee designated as such by the president. The president shall communicate his or her designation of the Title IX Officer to the community college as part of the president's statement as set forth in Section I, Part 1.

(4) The student or employee who files a complaint alleging discrimination or sexual harassment (the complainant) may submit a brief written statement of facts through one of the college representatives to the Title IX Officer. If the complainant does not submit a written statement, the Title IX Officer shall prepare a statement of facts which is approved by the complainant.

(5) The Title IX Officer shall appoint one of the college representatives to investigate the complaint. The Title IX Officer shall inform the complainant of the appointment.

(6) The college representative shall conduct an investigation based upon the written statement submitted by the complainant. If the complainant did not file a written statement, the representative shall conduct an investigation based upon the statement prepared by the Title IX Officer. The Title IX Officer will notify the person who is alleged to have committed the discrimination, or the harassment (respondent) of the complaint.

(7) The college representative shall conduct a thorough investigation. The investigation shall include, but is not limited to, providing the complainant and the respondent the opportunity to state their positions and interviewing witness. The investigation shall be concluded within a reasonable time, normally thirty days.

(8) At the conclusion of the investigation the college representative shall set forth his or her findings and recommendations in writing. The representative shall send a copy of the findings and recommendations to the complainant, the respondent, and the Title IX Officer.

(9) The Title IX Officer shall consider the findings and recommendations of the representative. The Title IX Officer shall determine whether disciplinary action is appropriate. The Title IX Officer shall advise the complainant and respondent of his or her decision.

(10) If the Title IX Officer determines that disciplinary actions should be instituted against an employee the applicable provisions of employee rights and responsibilities shall be followed. These provisions include but are limited to, state and federal constitutional and statutory provisions, rules of the higher education personnel board, collective bargaining agreements, and college policies.

(11) If the Title IX Officer determines that disciplinary action should be instituted against a student, the applicable provisions of the college student code shall be followed.

(12) If the Title IX Officer determines that disciplinary action is not appropriate and the complainant disagrees, the complainant may appeal, in writing, to the president.

(13) The procedures regarding complaints of discrimination shall be published and distributed as determined by the Title IX Officer. Any person who believes he or she has been subjected to sexual harassment will be provided a copy of this policy and procedure.

Chapter 132I-325 WAC  
SEPA RULES

NEW SECTION

**WAC 132I-325-010 IMPLEMENTATION OF STATE ENVIRONMENTAL POLICY ACT.** (1) It shall be the policy of Community College District No. 9 that all actions taken by the district shall comply with the provisions of chapter 43.21C RCW (State Environmental Policy, chapters 197-11 and 131-24 WAC, as presently enacted or hereafter amended).

Chapter 132I-400 WAC  
LOSS OF ELIGIBILITY—STUDENT ATHLETIC  
PARTICIPATION

NEW SECTION

**WAC 132I-400-010 GROUNDS FOR INELIGIBILITY.** Any student found by the college to have violated chapter 69.41 RCW by virtue of a criminal conviction or otherwise insofar as it prohibits the possession, use, or sale of legend drugs, including anabolic steroids, will be disqualified from participation in any school-sponsored athletic event or activity.

NEW SECTION

WAC 132I-400-020 **SUSPENSION PROCEDURE—RIGHT TO HEARING.** Any student notified of a claimed violation of WAC 132I-400-010 shall have the right to a brief adjudicative hearing if a written request for such a hearing is received by the dean of students within twenty-one days of receipt of a declaration of further athletic ineligibility. If no written request is received within twenty-one days after receipt of the declaration of athletic ineligibility, the student will be deemed to have waived any right to a brief adjudicative hearing and will be declared ineligible from further participation in school-sponsored athletic events for the remainder of the school year.

NEW SECTION

WAC 132I-400-030 **SUSPENSION PROCEDURE—HEARING.** If a timely written request for a hearing is made, the dean of students shall designate a hearing officer who shall be a college officer who is not involved with the athletic program to conduct the brief adjudicative hearing. The hearing officer shall promptly conduct the hearing and permit affected parties to explain both the college's view of the matter and the student's view of the matter. The brief adjudicative proceeding shall be conducted in accordance with the Administrative Procedure Act, RCW 34.05.482 through 34.05.494.

NEW SECTION

WAC 132I-400-040 **DECISION.** (1) The college official who acts as hearing officer shall issue a written decision which shall include a brief statement of the reasons for the decisions and a notice that judicial review may be available. All documents presented, considered, or prepared by the hearing officer shall be maintained as the official record of the brief administrative proceeding. A decision must be promptly rendered after the conclusion of the brief adjudicative hearing and in no event later than twenty days after the request for hearing is received by the dean of students.

(2) The student may appeal the hearing officer's decision to the president, in accordance with the procedures set forth in WAC 132I-120-450. The president's decision shall be final.

Chapter 132I-500 WAC  
SEVERABILITY

NEW SECTION

WAC 132I-500-010 **SEVERABILITY.** If any provision of this title or its application to any person or circumstance is held invalid, the remainder of the title or

the application of the provision to other persons or circumstances is not affected.

**WSR 92-15-116**  
**PROPOSED RULES**  
**PUBLIC DISCLOSURE COMMISSION**

[Filed July 21, 1992, 2:03 p.m.]

Original Notice.

Title of Rule: Amend WAC 390-16-032 Forms—Auction report.

Purpose: Adopts form for reporting items donated and sold at auctions.

Statutory Authority for Adoption: RCW 42.17.370.

Summary: This form serves as a means for treasurers to report items donated and sold at auctions.

Reasons Supporting Proposal: Change in instructions on reverse side of form for clarity.

Name of Agency Personnel Responsible for Drafting, Implementation and Enforcement: Graham Johnson, Public Disclosure Commission, Olympia, 753-1111.

Name of Proponent: Public Disclosure Commission, governmental.

Rule is not necessitated by federal law, federal or state court decision.

Explanation of Rule, its Purpose, and Anticipated Effects: This rule adopts a form for use in reporting items sold at auctions. The instructions are being revised for clarity.

Proposal does not change existing rules.

No small business economic impact statement is required for this proposal by chapter 19.85 RCW.

Hearing Location: Second Floor Conference Room, Evergreen Plaza Building, 711 Capitol Way, Olympia, WA 98501, on August 25, 1992, at 9 a.m.

Submit Written Comments to: Public Disclosure Commission, P.O. Box 40908, Olympia, WA 98504-0908, by August 10, 1992.

Date of Intended Adoption: August 25, 1992.

July 21, 1992  
Graham E. Johnson  
Executive Director

AMENDATORY SECTION (Amending WSR 89-20-068, filed 10/4/89)

WAC 390-16-032 **FORMS—AUCTION REPORT.** The official form for reporting items donated and sold at auctions, as required by RCW 42.17.090 (1)(b), is designated "Attachment Au", revised 1/90. This attachment shall accompany each C-3 which reports the receipt of funds from an auction. Copies of this form are available at the commission office, Room 403, Evergreen Plaza Building, Olympia, Washington, 98504.

# AUCTION REPORT

Use this form as an attachment to C3 to report items donated and sold at auctions.  
Please see the reverse for an example of a report.

ATTACHMENT  
TO C3

# Au

Candidate or committee name \_\_\_\_\_ Date auction was held \_\_\_\_\_

Item No. description	Name and address	Fair market value	Sale price	Amount over fair market value	Total given by this person during campaign
Contributor					
Buyer					
Contributor					
Buyer					
Contributor					
Buyer					
Contributor					
Buyer					
Contributor					
Buyer					
Contributor					
Buyer					
Contributor					
Buyer					

Cash receipts, this page  
(Total, sale price column) → \_\_\_\_\_

Total from attached pages → \_\_\_\_\_

Total cash receipts  
(Put this amount in part 1d of C3 report) → \_\_\_\_\_

See instructions on reverse

I certify that the information herein is true, correct and complete to the best of my knowledge.

Treasurer's signature

Date

**Instructions**

Use this form as an attachment to your C3 (Cash Receipts and Bank Deposits).

**Item No. Description:** As each item to be auctioned is received, assign it a number and a brief description.

**Contributor:** The person or organization which donates an article to be auctioned. If your committee purchases items for auction, state "purchased by committee" under contributor's name.

**Buyer:** The person who buys the item being auctioned.

**Fair market value:** The retail value of the article. If the retail value cannot be estimated or found, state "unknown."

**Sale price:** The amount the buyer paid for the item.

**Amount over fair market value:** The amount the sale price exceeds fair market value. If sale price is less than fair market value, leave blank.

**Total given by this person during campaign:**

**Contributor—**Fair market value of the item plus all previous contributions made to the candidate or committee.

**Buyer—**Amount over fair market value plus all previous contributions made to candidate or committee.

**Cash payments:** A payment of more than \$50.00 may not be accepted unless a receipt, signed by the buyer and the candidate, treasurer or deputy treasurer is prepared and made part of the committee's financial records.

**AUCTION REPORT**

Use this form as an attachment to C3 to report items donated and sold at auctions.

Candidate or committee name				Date auction was held	
JONES FOR SHERIFF COMMITTEE				9/14/XX	
Item No. description	Name and address	Fair market value	Sale price	Amount over fair market value	Total given by this person during campaign
NO. 1 USE BEACH CABIN	Contributor JOHN DOE 200 "A" STREET, SEATTLE 98101	\$100			\$100
	Buyer MARY SMITH 400 "B" STREET, TACOMA 98402		\$125	\$25	\$25
NO. 2 DINNER FOR 4	Contributor SAM BROWN 123 MILITARY ROAD, ANYTOWN 99101	\$80			\$80
	Buyer TOM MIX RT. 2, BOX 1, SADDLE MT. 98900		\$60		
NO. 3 BOAT CRUISE	Contributor CAPT. MOBY DICK 401 WATERFRONT, POULSBO 98701	\$75			\$75
	Buyer MERRI RYDER 204 E. LAND, MYBURG 99100		\$90	\$15	\$15
	Contributor				
	Buyer				
Cash receipts, this page (Total, sale price column)			\$275.00		
Total from attached pages			0		
Total cash receipts (Put this amount in part 1d of C3 report)			\$275.00		

# AUCTION REPORT

ATTACHMENT **Au**  
TO C3

Use this form as an attachment to C3 to report items donated and sold at auctions.  
Please see the reverse for an example of a report.

Candidate or committee name	Date auction was held
-----------------------------	-----------------------

Item No. description	Name and address	Fair market value	Sale price	Amount over fair market value	Total given by this person during campaign
Contributor					
Buyer					
Contributor					
Buyer					
Contributor					
Buyer					
Contributor					
Buyer					
Contributor					
Buyer					
Contributor					
Buyer					

Cash receipts, this page  
(Total, sale price column) →

----- →

Total from attached pages →

----- →

Total cash receipts →  
(Put this amount in part 1d of C3 report)

See instructions on reverse

I certify that the information herein is true, correct and complete to the best of my knowledge.	
Treasurer's signature	Date

**Instructions**

Use this form as an attachment to your C3 (Cash Receipts and Bank Deposits).

Item No. description: As each item to be auctioned is received, assign it a number and a brief description.

Contributor: The person or organization which donates an article to be auctioned. If your committee purchases items for auction, state "purchased by committee" under contributor's name.

Buyer: The person who buys the item being auctioned.

Fair market value: The retail value of the article. If the retail value cannot be estimated or found, state "unknown."

Sale price: The amount the buyer paid for the item.

Amount over fair market value: The amount the sale price exceeds fair market value. If sale price is less than fair market value, leave blank.

Total given by this person during campaign:

Contributor—Fair market value of the item (substitute sale price, if lower) plus all previous contributions made to the candidate or committee.

Buyer—Amount over fair market value plus all previous contributions made to candidate or committee.

Cash payments: A payment of more than \$50.00 may not be accepted unless a receipt, signed by the buyer and the candidate, treasurer or deputy treasurer is prepared and made part of the committee's financial records.

**AUCTION REPORT**

Use this form as an attachment to C3 to report items donated and sold at auctions.

Candidate or committee name				Date auction was held	
JONES FOR SHERIFF COMMITTEE				9/14/XX	
Item No. description	Name and address	Fair market value	Sale price	Amount over fair market value	Total given by this person during campaign
NO. 1 USE BEACH CABIN	Contributor JOHN DOE 200 "A" STREET, SEATTLE 98101	\$100			\$100
	Buyer MARY SMITH 400 "B" STREET, TACOMA 98402		\$125	\$25	\$25
NO. 2 DINNER FOR 4	Contributor SAM BROWN 123 MILITARY ROAD, ANYTOWN 99101	\$80			\$60
	Buyer TOM MIX RT. 2, BOX 1, SADDLE MT. 98900		\$60		
NO. 3 BOAT CRUISE	Contributor CAPT. MOBY DICK 401 WATERFRONT, POULSBO 98701	\$75			\$75
	Buyer MERRI RYDER 204 E. LAND, MYBURG 99100		\$90	\$15	\$15
	Contributor				
	Buyer				
Cash receipts, this page (Total, sale price column)			\$275.00		
Total from attached pages			0		
Total cash receipts (Put this amount in part 1d of C3 report)			\$275.00		

**WSR 92-15-117**  
**PROPOSED RULES**  
**DEPARTMENT OF AGRICULTURE**  
 [Filed July 21, 1992, 3:15 p.m.]

Date of Intended Adoption: September 1, 1992.

July 21, 1992

J. Allen Stine

Assistant Director/Commodity Inspection

**Original Notice.**

**Title of Rule:** Chapter 16-461 WAC, Inspection requirements for fruits and vegetables.

**Purpose:** To update and revise the existing rule to more accurately reflect conditions of industry practices.

**Statutory Authority for Adoption:** Chapter 15.17 RCW.

**Statute Being Implemented:** Chapter 15.17 RCW.

**Summary:** An emergency rule is currently in place exempting from inspection specific quantities of product which are marketed directly through fruit stands, farmers markets, and similar outlets within a "production zone." Typically, the exempted products are seasonal fresh fruits and asparagus.

**Reasons Supporting Proposal:** The revisions primarily affect seasonal soft tree fruits and the summer marketing of these products through fruit stands and farmers' markets. Relief from inspection requirements is necessary to alleviate burdensome or disproportionate fees on small volumes of products. Due to the highly seasonal nature and limited quantities of these perishable products, inspection requirements are often impractical. Also, due to unscheduled or unexpected arrivals by buyers, often during evening hours and on weekends when much of this type of transaction occurs, availability of inspection services is somewhat limited.

**Name of Agency Personnel Responsible for Drafting, Implementation and Enforcement:** James R. Archer, Olympia, Washington, (206) 753-5054.

**Name of Proponent:** Janet Allison, a fruit producer; other producers, and interested parties by petition to the Director of Agriculture, private.

Rule is not necessitated by federal law, federal or state court decision.

**Explanation of Rule, its Purpose, and Anticipated Effects:** The rule exempts small quantities of fresh apricots, Italian prunes, peaches, cherries, apples, pears, and asparagus from inspection requirements when marketed through fruit stands, farmers' markets and similar type outlets with the "production zone."

**Proposal Changes the Following Existing Rules:** An emergency rule containing the proposed revisions is currently in effect. The proposal will change the permanent rule which has no provision for exemption of inspection requirements for small quantities of product.

No small business economic impact statement is required for this proposal by chapter 19.85 RCW.

**Hearing Location:** Best Western Ellensburg Inn, 1700 Canyon Road, Ellensburg, WA 98926, on August 25, 1992, at 10:00 a.m.

**Submit Written Comments to:** James R. Archer, Fruit/Vegetables Program Manager, Washington State Department of Agriculture, P.O. Box 42560, Olympia, WA 98504-2560, by August 25, 1992.

**AMENDATORY SECTION** (Amending WSR 92-06-085, filed 3/4/92, effective 4/4/92)

**WAC 16-461-006 DEFINITIONS.** (1) Commercial lot shall mean any number of any type of containers or any quantity in bulk of agricultural products listed in WAC 16-461-010, which are sold or bartered: **PROVIDED**, That quantities of less than five hundred pounds net weight, when sold by any producer where grown by the producer and sold directly to the ultimate consumer, shall not be considered as a commercial lot.

(2) Fruit/produce stands, as used in this chapter, shall mean any facilities from which the predominance of the edible commodity sales to the public are of seasonal fresh fruits and/or vegetables produced within the state of Washington, and shall include roadside stands, farmer's markets, trucks or other conveyances from which sales of commodities are made, and temporary open air parking lot stands other than those owned or operated by retail grocery stores. Such facilities may or may not be owned, leased, or otherwise operated by the producer of fruits and/or vegetables.

(3) Zone of production shall be defined as one of two geographical areas: Zone 1: All counties west of the Cascade Mountain Range; Zone 2: The counties of Adams, Asotin, Benton, Chelan, Columbia, Douglas, Ferry, Franklin, Garfield, Grant, Kittitas, Klickitat, Lincoln, Okanogan, Pend Oreille, Skamania, Spokane, Stevens, Walla Walla, Whitman, and Yakima.

**AMENDATORY SECTION** (Amending WSR 92-06-085, filed 3/4/92, effective 4/4/92)

**WAC 16-461-010 INSPECTION CERTIFICATE AND/OR PERMIT REQUIRED.** (1) No person shall ship, transport, accept for shipment, or accept delivery of, any commercial lot of the following agricultural products without an inspection and the issuance of a certificate and/or a permit by the commodity inspection division of the department of agriculture allowing such shipment, movement or delivery:

- (a) Apricots - in closed or open containers for fresh market.
- (b) Italian prunes - in closed or open containers for fresh market.
- (c) Peaches - in closed or open containers for fresh market.
- (d) Cherries - in closed or open containers for fresh market: **PROVIDED**, That no permit shall be issued on cherries infested with live cherry fruit fly larvae.
- (e) Apples - in closed or open containers for fresh market: **PROVIDED**, That apples may be shipped or transported if accompanied by a certificate of compliance issued by the shipper or packer of apples having the approval of the director to issue the certificates of compliance.
- (f) Pears - in closed or open containers for fresh market: **PROVIDED**, That pears may be shipped or transported if accompanied by a certificate of compliance issued by the shipper or packer of pears having the approval of the director to issue the certificates of compliance.
- (g) Asparagus - in closed or open containers for fresh market: **PROVIDED**, That asparagus may be shipped or transported if accompanied by certificates of compliance issued by the shipper or packer of the asparagus, having the approval of the director to issue the certificates of compliance.
- (h) Apples in containers or bulk, for processing: **PROVIDED**, That apples for processing may be shipped or transported if accompanied by a certificate of compliance issued by the shipper of apples having the approval of the director to issue the certificates of compliance: **PROVIDED FURTHER**, That apples for processing entering intrastate commerce shall not require a permit.
- (i) Pears in containers or bulk, for processing: **PROVIDED**, That pears for processing may be shipped or transported if accompanied by a certificate of compliance issued by the shipper of pears having the approval of the director to issue the certificates of compliance: **PROVIDED FURTHER**, That pears for processing entering intrastate commerce shall not require a permit.

(2) Exemptions - Fruits and vegetables listed in WAC 16-461-010 shall be exempted from requirements for inspection and issuance of a certificate or permit:

(a) When the product is being transported from the premises where grown or produced to a horticultural facility other than wholesale or retail for the purpose of storing, grading, packing, packaging, labelling, or processing; prior to entering commercial channels for resale;

(b) When transportation is between horticultural facilities other than those facilities which sell at wholesale or retail level, for the purposes set forth in (a) of this subsection;

(c) When sold or transported to a fruit/produce stand within the zone of production, not to exceed daily quantities of two thousand pounds net weight of a single commodity nor six thousand pounds net weight of any combination of commodities listed in subsection (1) of this section, when on a single conveyance, provided that such exempt sales by the producer within a farmer's market shall not be restricted to the zone of production.

(3)(a) Any shipper or packer of apples, apricots, cherries, pears, peaches, prunes, or asparagus may petition the director for authority to issue certificates of compliance for each season. The director may issue certificate of compliance agreements, granting such authority, on such terms and conditions as he may deem appropriate. The authority shall be limited to the issuance of certificates of compliance for apples, apricots, cherries, pears, peaches, prunes, and asparagus under the applicant's direct control or being handled at the shipper's or packer's facilities.

(b) The certificate of compliance shall be issued at time of shipment by the shipper or packer authorized to do so: PROVIDED, That the apples and/or pears and asparagus about to be shipped or transported are in full compliance with the requirements of chapter 15.17 RCW, regulations adopted thereunder and administrative directives of the director: PROVIDED FURTHER, That apricots, cherries, peaches, prunes, or pears about to be shipped or transported are in full compliance with the federal marketing order requiring quality and condition certification and Washington state lot identification or federal-state lot identification.

(c) The director's approval to issue certificates of compliance may be suspended, revoked, or denied for cause, subject to RCW 34.05.422(3) and that cause shall be the shipper's or packer's failure to comply with the requirements of subsection (3)(b) of this section, or for the shipper's or packer's actions which impede the department's abilities to ascertain full compliance with requirements of chapter 15.17 RCW or rules adopted thereunder, or for violation of the terms of the certificate of compliance agreement. The period of any suspension shall be determined by the director and shall be commensurate with the seriousness of the violation.

(d) Any shipper or packer whose authority to issue certificates of compliance has been suspended, revoked, or denied by the director shall be subject to those provisions of chapter 15.17 RCW and the regulations requiring the issuance of a shipping permit by the director before apples, apricots, cherries, pears, peaches, prunes, and asparagus may be shipped or transported.

(e) Certificates of compliance shall be on forms approved and issued by the director of agriculture.

(f) Any shipper or packer authorized to issue certificates of compliance shall deposit with the director of agriculture at the regular base fee equivalent to that charged by the director for a shipping permit, for each certificate of compliance issued by the authorized shipper or packer. The base fees shall be deposited with the director of agriculture in the same manner as fees for shipping permits.

**WSR 92-15-118**  
**PERMANENT RULES**  
**PARKS AND RECREATION**  
**COMMISSION**

[Filed July 21, 1992, 4:02 p.m.]

Date of Adoption: July 17, 1992.

Purpose: Expands the hours that parks are open to metal detectors and clarifies what kinds of tools can be used.

Citation of Existing Rules Affected by this Order:  
Amending WAC 352-32-235.

Statutory Authority for Adoption: RCW 43.51.040.

Pursuant to notice filed as WSR 92-12-080 on June 2, 1992.

Effective Date of Rule: Thirty-one days after filing.

July 17, 1992

Mel Wortman

Chairman

**AMENDATORY SECTION** (Amending WSR 90-04-025, filed 1/29/90, effective 3/1/90)

**WAC 352-32-235 USE OF METAL DETECTORS IN STATE PARKS.** The use and operation of metal detectors, as well as the removal of (~~found~~) small contemporary materials, is permitted within selected state parks as designated by the director, subject to the conditions and limitations specified.

(1) The use of metal detectors is permitted only within specified portions of the developed day use areas of these state parks as posted for public reference.

(2) The use of metal detectors within a state park shall be limited to daylight hours (~~of operation before 10:00 a.m. from the Friday before Memorial Day through Labor Day, and shall be limited to the hours of operation at other times of the year.~~) that the park has posted as "open." No use shall be allowed during periods of seasonal or emergency park closure.

(3) Any person wishing to use a metal detector shall so indicate to park personnel at the park where the use is to occur, by complying with the registration process provided for such purpose.

(4) Exceptional uses of metal detectors in state parks may be allowed through the issuance of a special recreation event application, available from the agency.

(5) This section does not apply to commission employees while engaged in the performance of their duties.

(6) Persons operating metal detectors in state parks and state park areas shall:

(a) Observe all laws and regulations.

(b) Never destroy or disturb park facilities, natural features, or historical or archeological resources. No item which appears to be of historical or archaeological significance, remaining from either early pioneer activity or from a native American presence, may be removed from the site at which it was found. Any such find shall be immediately reported to park personnel, and the area in which the find occurred shall not be disturbed further.

(c) Limit digging implements to ice picks, screwdrivers and probes not to exceed (~~one inch width~~) two inches in width and sand scoops not to exceed six inches in width and eight inches in length, containing perforations no less than one-half inch in width, to be used only on sand surfaces. Any holes dug shall be limited to six inches maximum depth and shall be immediately refilled and the surface restored to its earlier condition.

(d) Properly dispose of all found or recovered trash and litter.

(e) Conduct themselves with thoughtfulness, courtesy and consideration for others, and not interfere with other recreational activities. An operator shall not allow any emitted metal detector sound audible to other park users from the Friday before Memorial Day through Labor Day.



**WSR 92-15-119**  
**PERMANENT RULES**  
**PARKS AND RECREATION**  
**COMMISSION**

[Filed July 21, 1992, 4:05 p.m.]

Date of Adoption: July 17, 1992.

Purpose: Requires Washington residents vehicles to display Washington state sno-park permit decals.

Citation of Existing Rules Affected by this Order: Amending WAC 352-32-260.

Statutory Authority for Adoption: RCW 43.51.040(1), 43.51.050(3), and 43.51.290(2).

Pursuant to notice filed as WSR 92-12-012 on May 22, 1992.

Effective Date of Rule: Thirty-one days after filing.  
July 17, 1992  
Mel Wortman  
Chairman

**AMENDATORY SECTION** (Amending Order 38, filed 1/17/78)

WAC 352-32-260 SNO-PARK PERMIT. Only those vehicles properly displaying a valid winter recreational area parking permit issued by the state of Washington or by another state or nation which honors a Washington state winter recreational area parking permit shall park in designated winter recreational parking areas: PROVIDED, That Washington licensed vehicles shall be required to display a Washington state winter recreational area parking permit. Those vehicles in violation of this rule shall be subject to the application of RCW 46.61.587.

**WSR 92-15-120**  
**PERMANENT RULES**  
**PARKS AND RECREATION**  
**COMMISSION**

[Filed July 21, 1992, 4:06 p.m.]

Date of Adoption: July 17, 1992.

Purpose: Presently, Washington State Parks and Recreation only offers two types of permits: Seasonal and 3-day. This WAC change will offer a one-day permit.

Citation of Existing Rules Affected by this Order: Amending WAC 352-32-270.

Statutory Authority for Adoption: RCW 43.51.040.

Pursuant to notice filed as WSR 92-12-081 on June 2, 1992.

Effective Date of Rule: Thirty-one days after filing.  
July 17, 1992  
Mel Wortman  
Chairman

**AMENDATORY SECTION** (Amending WSR 91-09-001, filed 4/4/91, effective 10/1/91)

WAC 352-32-270 SNO-PARK PERMIT—FEE. The fees and commencement and expiration dates for ((a)) winter recreational area parking permits issued by the state of Washington shall be as follows:

(1) Seasonal permit – \$20.00 per vehicle per season – commences October 1 and expires May 1 of the winter season for which it is issued.

(2) Three day permit – \$10.00 per vehicle – commences on the date identified on the permit in the space provided and expires no later than twelve midnight two consecutive days later.

(3) One day permit – \$7.00 per vehicle – commences on the date identified on the permit in the space provided and expires on that same date.

**WSR 92-15-121**  
**PERMANENT RULES**  
**PARKS AND RECREATION**  
**COMMISSION**

[Filed July 21, 1992, 4:07 p.m.]

Date of Adoption: July 17, 1992.

Purpose: Land exchange transfer fee is considered paid by the difference in land value.

Citation of Existing Rules Affected by this Order: Amending WAC 352-32-295.

Statutory Authority for Adoption: Chapter 43.51 RCW.

Pursuant to notice filed as WSR 92-12-082 on June 2, 1992.

Effective Date of Rule: Thirty-one days after filing.  
July 17, 1992  
Mel Wortman  
Chairman

**AMENDATORY SECTION** (Amending Order 80, filed 10/2/84)

WAC 352-32-295 LAND EXCHANGE—FEE. A party who exchanges land with the commission shall pay a nonrefundable transfer fee to the commission of one hundred dollars for each exchange. When the exchange includes a transfer to the commission of land valued at one hundred dollars or more than the value of land transferred by the commission, the transfer fee shall be considered paid by the difference in the land value.

**WSR 92-15-122**  
**PROPOSED RULES**  
**SUPERINTENDENT OF**  
**PUBLIC INSTRUCTION**

[Filed July 21, 1992, 4:09 p.m.]

Original Notice.

Title of Rule: Chapter 392-100 WAC, Rules of construction.

Purpose: To correct a previous reference in the section.

Statutory Authority for Adoption: RCW 28A.150.290.

Statute Being Implemented: Section 506, chapter 16, Laws of 1991 1st ex. sess.

Summary: Corrects erroneous reference in existing rule.

Reasons Supporting Proposal: See Purpose above.

Name of Agency Personnel Responsible for Drafting: Rick M. Wilson, Superintendent of Public Instruction, Old Capitol Building, (206) 753-2298; Implementation: David L. Moberly, Superintendent of Public Instruction, Old Capitol Building, (206) 753-6742 and Enforcement: Don M. Carnahan, Superintendent of Public Instruction, Old Capitol Building, (206) 753-0235.

Name of Proponent: Superintendent of Public Instruction, governmental.

Rule is not necessitated by federal law, federal or state court decision.

Explanation of Rule, its Purpose, and Anticipated Effects: See Purpose above.

Proposal Changes the Following Existing Rules: Corrects reference.

No small business economic impact statement is required for this proposal by chapter 19.85 RCW.

Hearing Location: Superintendent of Public Instruction, Old Capitol Building, Wanamaker Conference Room, 2nd Floor, Olympia, Washington 98504-7200, on August 28, 1992, at 9:00 a.m.

Submit Written Comments to: Richard M. Wilson, P.O. Box 47200, Olympia, WA 98504-7200, by August 25, 1992.

Date of Intended Adoption: September 4, 1992.

July 21, 1992  
 Judith A. Billings  
 Superintendent of  
 Public Instruction

**AMENDATORY SECTION** (Amending Order 92-04, filed 1/22/92, effective 2/22/92)

WAC 392-100-101 DOCUMENTATION OF LOW-INCOME ELIGIBILITY. For purposes of Title 392 WAC, a student's eligibility as a low-income student shall be documented by either:

(1) A notice of eligibility presented by a parent or guardian of the student indicating that the student is approved for free or reduced priced meals or free milk for the current school year; or

(2) A statement or form signed by a parent or guardian of the student stating that the income of the student's parent(s) or guardian(s) meets the criteria for low-income during the current school year pursuant to WAC ((392-122-302)) 392-100-100.

**WSR 92-15-123**  
**PROPOSED RULES**  
**SUPERINTENDENT OF**  
**PUBLIC INSTRUCTION**  
 [Filed July 21, 1992, 4:11 p.m.]

Original Notice.

Title of Rule: WAC 392-153-032 Traffic safety education program requirements.

Purpose: To modify minimum instructional requirements for state approved traffic safety education programs.

Statutory Authority for Adoption: RCW 28A.220.030.

Statute Being Implemented: RCW 28A.220.030.

Summary: The minimum duration of traffic safety education courses is increased from five to nine weeks except for summer and commercial driving school courses. Behind the wheel driving requirements are modified.

Name of Agency Personnel Responsible for Drafting: Richard Wilson, Superintendent of Public Instruction, Olympia, 753-2298; Implementation: Gary Bloomfield, Superintendent of Public Instruction, Olympia, 753-6736; and Enforcement: Warren Burton, Superintendent of Public Instruction, Olympia, 753-6701.

Name of Proponent: Superintendent of Public Instruction, governmental.

Rule is not necessitated by federal law, federal or state court decision.

Explanation of Rule, its Purpose, and Anticipated Effects: The minimum duration of traffic safety education courses is increased from five weeks to nine weeks except for summer courses and courses offered by commercial driving schools which remain at five weeks. Required behind-the-wheel driving time is reduced from four to three hours if simulation and/or off-street driving ranges are used.

Proposal Changes the Following Existing Rules: See above.

No small business economic impact statement is required for this proposal by chapter 19.85 RCW.

Hearing Location: Superintendent of Public Instruction, Old Capitol Building, Wanamaker Conference Room, 2nd Floor, Olympia, Washington 98504-7200, on August 28, 1992, at 9:00 a.m.

Submit Written Comments to: Richard M. Wilson, P.O. Box 47200, Olympia, WA 98504-7200, by August 25, 1992.

Date of Intended Adoption: September 4, 1992.

July 21, 1992  
 Judith A. Billings  
 Superintendent of  
 Public Instruction

**AMENDATORY SECTION** (Amending Order 92-04, filed 1/22/92, effective 2/22/92)

WAC 392-153-032 REALISTIC LEVEL OF EFFORT. Each school district and commercial driving school shall have a locally written curriculum guide available to each teacher and such guide shall be used by each teacher in the traffic safety education program.

The student shall be taught at least the following program concepts: introduction to highway transportation system; preparing and controlling the vehicle; maneuvering in limited space; signs, signals, and pavement markings; vehicle characteristics; human functions used in driving; roadway variations; intersections; traffic flow tasks; lane changes; passing; nonmotorized traffic; internal factors affecting driving performance; physical factors affecting driving performance; alcohol and drugs; vehicle maintenance; planning for travel; limited visibility; reduced traction; special driving conditions; vehicle malfunctioning; avoiding and minimizing impact; post-crash responsibilities; legal responsibilities; highway transportation system improvement; fuel conservation; and motorcycle awareness. The guide shall also include:

(1) The performance objectives appropriate for the area of instruction.

(2) The methods of instruction used by the teacher in presenting the material.

(3) The student activities that will enable a student to accomplish the objectives and to the extent possible allow for individual differences.

(4) The level of competency each student is to successfully complete in each objective.

(5) The evaluation criteria for the classroom and laboratory phase.

A student shall meet the objectives and competencies listed in the district curriculum guide as a condition of successful completion of the traffic safety education program.

For the purposes of school district reporting and state reimbursement a completing student means a person under twenty-one years of age at the time of enrollment who has enrolled in an approved course and has met one of the following criteria:

(1) Has completed all the program objectives as required by the school district and approved by the state superintendent of public instruction and has received a passing grade; or

(2) Has received a failing grade after attending more than fifty percent of the program's scheduled classes but achieved less than ninety percent of the program objectives; or

(3) Has officially withdrawn, dropped, or transferred after attending more than fifty percent of the program's scheduled classes.

A student taking the course more than once because of a failing grade on the first and subsequent attempts may be counted as a completing student for each attempt.

The traffic safety education course including the classroom and the laboratory phase shall be provided for students in a time period not to exceed eighteen school weeks nor be less than ~~(five)~~ nine school weeks during the school year: PROVIDED, That summer school course offerings and commercial driving schools offering an approved program shall not be less than five weeks in length. A minimum five-week course of instruction is defined as not less than twenty-five hours of contact time in a classroom setting with a certified teacher and not less than four hours of actual driving behind the wheel. Where simulation and/or off-street multiple car driving ranges are utilized, not less than three hours of actual driving behind the wheel per student shall occur. In addition, the traffic safety education course shall:

(1) Provide students with no more than two hours of classroom instruction and one hour of on-street instruction during any twenty-four hour period. Where simulation and/or off-street multiple car driving ranges are utilized, not more than one additional hour per student per day shall be allowed.

(2) Provide laboratory instruction only to students who are currently participating in classroom instruction.

**WSR 92-15-124**  
**RULES COORDINATOR**  
**COMMISSION ON**  
**ASIAN AMERICAN AFFAIRS**

[Filed July 21, 1992, 4:25 p.m.]

Please be advised that Patricia M. Lee is our agency's contact person and rules coordinator.

Patricia M. Lee

**WSR 92-15-125**  
**ATTORNEY GENERAL OPINION**  
**Cite as: AGO 1992 No. 15**  
 [July 16, 1992]

**CITIES AND TOWNS—COUNTIES—COURTS—JUDGES—**  
**ESTABLISHMENT OF MUNICIPAL COURTS AND TERMINA-**  
**TION OF A MUNICIPAL DEPARTMENT OF THE DISTRICT**  
**COURT**

1. RCW 3.46.150 provides that a city may give notice to the county legislative authority to require termination of a municipal department of the district court. The municipal department is terminated through amendment to the county's district court districting plan.
2. A district court judge who had been serving in a municipal department of the district court remains a

district court judge following termination of the municipal department until he or she vacates the position prior to the end of his or her term, or the term expires.

3. The term of office for a judge of a municipal court established by city ordinance is four years.

Requested by:

Honorable Marlin Appelwick  
 State Representative, District 46'  
 Post Office Box 40691  
 Olympia, Washington 98504-0691

**WSR 92-15-126**  
**ATTORNEY GENERAL OPINION**  
**Cite as: AGO 1992 No. 16**  
 [July 16, 1992]

**CITIES AND TOWNS—ORDINANCES—CHARTERS—**  
**WHETHER AN ORDINANCE IS INVALID IF NOT PUBLISHED**  
**WITHIN A SPECIFIED NUMBER OF DAYS**

RCW 35.22.288 provides that the ordinances of first class cities, or a summary thereof, shall be promptly published in the official newspaper of the city. However, an ordinance is not invalid under RCW 35.22.288 if it is not published within a specified number of days.

Requested by:

Honorable Mike Padden  
 State Representative, District 4  
 425 John L. O'Brien Building  
 Post Office Box 40608  
 Olympia, Washington 98504-0608

**WSR 92-15-127**  
**PROPOSED RULES**  
**EASTERN WASHINGTON UNIVERSITY**  
 [Filed July 21, 1992, 4:28 p.m.]

Original Notice.

Title of Rule: General conduct code.

Purpose: To relocate former rules into a more appropriate chapter. Also to advise the public of the new smoking policy. Other sections involve ensuring the safety of individuals on campus, e.g., bomb threats, firearms, etc.

Statutory Authority for Adoption: RCW 28B.35.120.  
 Statute Being Implemented: RCW 70.160.010.

Summary: The new rules provide guidelines in the participation in civil demonstrations. Bomb threats are required to be reported immediately. Firearms policies and procedures are being proposed to ensure safety. Trespass guidelines have been established. Smoking regulations are set forth. Pet control guidelines have been proposed. A poster policy is proposed to enhance campus appearance.

Reasons Supporting Proposal: No guidelines have been in place to allow university police to exercise control over firearms on campus, pets, bomb threats, or violations of trespass, except for those provided by statute. The smoking policy is required by statute and agrees with the Washington Clean Indoor Air Act.

Name of Agency Personnel Responsible for Drafting: Ann Carrasco, SHW 318, (509) 359-6299; Implementation: Elson Floyd, Executive Vice-President, SHW 207, (509) 359-6293; and Enforcement: University Police, Red Barn, (509) 359-6300.

Name of Proponent: Eastern Washington University, governmental.

Rule is not necessitated by federal law, federal or state court decision.

Explanation of Rule, its Purpose, and Anticipated Effects: The rule will provide general guidelines to conduct on campus specifically where health and safety issues are a concern.

Proposal does not change existing rules.

No small business economic impact statement is required for this proposal by chapter 19.85 RCW.

Hearing Location: Eastern Washington University, Louise Anderson Hall, Cheney, Washington 99004, on September 18, 1992, at 10:00 a.m.

Submit Written Comments to: Ann Carrasco, Rules Coordinator, SHW 318, Mailstop 114, Cheney, Washington 99004-2496, by September 17, 1992, 5:00 p.m.

Date of Intended Adoption: September 18, 1992.

July 17, 1992

Ann Carrasco  
Rules Coordinator

Chapter 172-122 WAC  
GENERAL CONDUCT CODE

NEW SECTION

WAC 172-122-100 CIVIL DEMONSTRATIONS. The university shall make every attempt to protect participating and nonparticipating individuals during a civil demonstration, to include sit-ins which occur in a university office, structure, or on the property of Eastern Washington University. The following guidelines shall be observed in the event of any form of a civil demonstration.

- (1) One person shall act as a representative of the university in an effort to establish a clear line of communication.
- (2) The demonstrators will be asked to appoint a representative to communicate with the university representative.
- (3) Orderly behavior shall be maintained and university property shall not be damaged.
- (4) The demonstration shall not interfere with educational or business functions of the university.

The University News Bureau shall be the official contact for news media.

University police are authorized to take actions in accordance with Washington state and federal laws.

NEW SECTION

WAC 172-122-110 BOMB THREATS. Any university employee or student who receives a bomb threat must immediately notify the university police. University employees and students who fail to report bomb threats will be subject to disciplinary action by the university.

Bomb threats against the university will be prosecuted to the full extent of the law.

NEW SECTION

WAC 172-122-120 FIREARMS. Violations of the subsections of this section are subject to appropriate disciplinary or legal action.

(1) Possession, carrying, or discharge of any explosive, firearm, chemical weapon (or dangerous chemical) or other weapon; including shotguns, pistols, air guns, pellet guns, and paint ball guns, whether loaded or unloaded; is prohibited on property owned or controlled by Eastern Washington University.

(2) Only people who are authorized to carry firearms or other weapons as duly appointed and commissioned law enforcement officers in the state of Washington, or commissioned by agencies of the United States government, shall possess firearms or other weapons issued for their possession by their respective law enforcement agencies while on campus or other university-controlled property, including residence halls. A law enforcement agent must notify the university police of his or her presence on campus on arrival.

(3) Other than the people referenced in subsection (2) of this section, members of the campus community and visitors who bring firearms or other weapons to campus must immediately place the firearms or weapons in the university-provided storage facility, located at the red barn. The storage facility is controlled by the university police office and is accessible twenty-four hours per day throughout the year.

(4) Anyone seeking to bring a firearm or other weapon onto campus for display or demonstration purposes directly related to a class or other educational activity must obtain prior authorization from the university police department. The university police department shall review any such request and may establish conditions to the authorization.

(5) Firearms owned by the institution for use by special interest groups such as university-sponsored gun clubs, ROTC, or intercollegiate shooting teams, must be stored in a location approved by the university police department. These firearms must be checked out by the club advisor or coach and are to be used by legitimate members of the club or team in the normal course of the club or team's related activity.

NEW SECTION

WAC 172-122-200 NOTICE OF TRESPASS. The president of Eastern Washington University, or in the president's absence, the acting president, is authorized in the instance of any event that the president deems to be disruptive of order or which the president deems impedes the movement of persons or vehicles or which the president deems to disrupt or threatens to disrupt the ingress and/or egress of persons from publicly owned buildings or related facilities owned by the university, then the president acting through the executive vice-president or other persons designated by the president, shall have the power and authority to:

- (1) Prohibit the entry of, or withdraw the license or privilege of any person or persons, or any group of persons, to enter onto or remain on all or any portion of real property or in any building or facility thereon or attached thereto which is owned or operated by the university; or
- (2) Give notice against trespass by any manner specified in chapter 9A.52 RCW to any person, persons, or group of persons against whom the license or privilege has been withdrawn or who have been prohibited from entering onto or remaining on all or any portion of real property or in any building or facility thereon or attached thereto, which property is owned or operated by the university; or
- (3) Order any person, persons, or group of persons to leave or vacate all or a portion of real property or any building or facility thereon or attached thereto which is owned or operated by the university.

NEW SECTION

WAC 172-122-210 RESTRICTION OF ACCESS. The president of Eastern Washington University shall be authorized to reasonably restrict the access to any portion of real property or any building or facility thereon or attached thereto, owned by the university by designating the person, persons, or class of persons who is privileged to enter on or into or remain on university-owned real property or buildings or facilities thereon or attached thereto. Additionally, the president may prescribe reasonable hours of occupancy and reasonable conduct during occupancy for those persons or class of persons which are privileged to enter on or into or remain in any building or facility owned by Eastern Washington University.

**NEW SECTION**

WAC 172-122-300 **SMOKING REGULATIONS.** The smoking of tobacco substances at Eastern Washington University is subject to the following rules:

(1) Smoking is allowed in designated areas only. The appropriate provost/vice-president shall be responsible for designating smoking areas under the guidelines of this policy.

(2) Some university buildings are designated as smoke free; no smoking is allowed in any location of these buildings.

(3) All designated smoking areas must have physical barriers and ventilation systems which prevent toxic smoke contaminants from entering adjacent nonsmoking areas.

(4) Smoking is not permitted in nonposted areas. Signs will be posted to identify smoke-free buildings and, if a smoking area is designated, the location of that area.

(5) Smoking cessation programs will be provided by the university as needed. Employees who wish to stop smoking are encouraged to attend.

**COMPLIANCE AND ENFORCEMENT:**

(6) All members of the university are expected to comply with the law and this policy.

(7) Concerns about smoking practices should be directed to the environmental health and safety office.

(8) Violations of the policy will be reviewed in light of chapter 70.160 RCW.

**NEW SECTION**

WAC 172-122-400 **PET CONTROL.** Guide or service dogs as defined at chapter 70.84 RCW are distinguished from references to pets in this section and WAC 172-122-410 and, therefore, are granted full and equal access to university facilities when accompanied and under the control of a disabled individual. In order to assure the health and safety of a person on property owned or controlled by Eastern Washington University, the following rules and regulations regarding pet control are hereby promulgated:

(1) Title 7 of the municipal code of the city of Cheney, Washington, relating to animal control shall be expressly applicable to all portions of the Eastern Washington University properties contained within the city of Cheney, Washington.

(2) State and county laws relating to animal control are expressly applicable to all portions of the Eastern Washington University properties outside the city of Cheney, Washington.

(3) No person will be permitted to bring any pet on properties owned or controlled by Eastern Washington University unless the pet is under the immediate control of the person: **PROVIDED,** That pets are not permitted to enter into buildings owned or controlled by Eastern Washington University.

**NEW SECTION**

WAC 172-122-410 **PENALTIES FOR VIOLATIONS OF PET CONTROL REGULATIONS.** (1) Persons violating WAC 172-122-400 may be referred to an appropriate court of law for prosecution. Sworn police officers of Eastern Washington University shall have express authority to refer the violations to appropriate courts of law.

(2) Pets found to be in violation of WAC 172-122-400 may be impounded by any employee of the Eastern Washington University police

**Reviser's note:** The typographical error in the above section occurred in the copy filed by the agency and appears in the Register pursuant to the requirements of RCW 34.08.040.

**WSR 92-15-128****PROPOSED RULES****EASTERN WASHINGTON UNIVERSITY**

[Filed July 21, 1992, 4:35 p.m.]

Original Notice.

Title of Rule: Commercial activities.

Purpose: Provides guidelines for commercial solicitation on campus.

Statutory Authority for Adoption: RCW 28B.35.120.

Summary: Prohibits commercial solicitation except where related to the university's role and mission.

Reasons Supporting Proposal: The university campus is a common place for solicitors to visit due to the quantity of people in one central location which makes it desirable to solicitors.

Name of Agency Personnel Responsible for Drafting: Ann Carrasco, SHW 318, (509) 359-6299; Implementation: Elson Floyd, SHW 207, (509) 359-6293; and Enforcement: Elson Floyd or designee, SHW 207, (509) 359-6293.

Name of Proponent: Eastern Washington University, governmental.

Rule is not necessitated by federal law, federal or state court decision.

Explanation of Rule, its Purpose, and Anticipated Effects: Rule provides regulations on campus to potential solicitors. It is the goal of university to reduce the amount of handbills placed on cars. We hope that the chapter will improve this problem. Abandoned handbills often litter the campus.

Proposal does not change existing rules.

No small business economic impact statement is required for this proposal by chapter 19.85 RCW.

Hearing Location: Eastern Washington University, Louise Anderson Hall, Cheney, Washington 99004-2496, on September 18, 1992, at 10:00 a.m.

Submit Written Comments to: Ann Carrasco, SHW 318, Mailstop 114, Cheney, Washington 99004-2496, by September 17, 1992, 5:00 p.m.

Date of Intended Adoption: September 18, 1992.

July 17, 1992

Ann Carrasco

Rules Coordinator

Chapter 172-139 WAC  
**COMMERCIAL ACTIVITIES**

**NEW SECTION**

WAC 172-139-010 **COMMERCIAL ACTIVITIES.** Eastern Washington University facilities shall not be used for commercial solicitation, advertising, or promotional activities except when the activities clearly serve educational objectives, including but not limited to display of books of interest to the academic community or the display or demonstration of technical or research equipment, and when the commercial activities relate to educational objectives and are conducted under the sponsorship or at the request of a university department or of the executive vice-president or authorized designee: **PROVIDED,** That commercial activities shall not interfere with or operate to the detriment of the conduct of university affairs or the free flow of pedestrian or vehicular traffic.

**NEW SECTION**

WAC 172-139-020 **COMMERCIAL ACTIVITIES IN THE PENCE UNION BUILDING.** Exceptions to WAC 172-139-010 are granted for the Pence Union Building (PUB): **PROVIDED,** That the activity does not duplicate services provided by the university and prior approval is obtained from the director of student auxiliary services. Vendors are assessed charges for use of the PUB.

**NEW SECTION**

WAC 172-139-030 **HANDBILLS.** (1) No person shall place in or on any vehicle parked on the university campus, any handbill, except as provided in subsection (2)(c) of this section.

(2) For the purposes of this chapter, the following definition applies: A "handbill" is any printed or written matter, sample, or device which:

(a) Advertises for sale any merchandise, product, service, or commodity; or

(b) Directs attention, either directly or indirectly, to any business or mercantile or commercial establishment, or other activity, for the purpose of promoting an interest in sales or use; or

(c) Directs attention to or advertises any meeting, theatrical performance, exhibition, or event of any kind, for which an admission fee is charged for the purpose of private gain or profit: PROVIDED, That the terms of this clause shall not apply to a university-sponsored activity for which the handbills have been approved for such distribution by the director of student auxiliary services in the Pence Union Building.

#### NEW SECTION

WAC 172-139-040 PENALTIES FOR VIOLATIONS OF COMMERCIAL ACTIVITIES REGULATIONS. (1) Any violation of this chapter by a student of Eastern Washington University is a violation of the student conduct code, WAC 172-120-040.

(2) Nonstudents violating this chapter may be referred to civil authorities for appropriate prosecutions, including violations of the laws of criminal trespass and/or litter control.

### WSR 92-15-129

#### PROPOSED RULES

### EASTERN WASHINGTON UNIVERSITY

[Filed July 21, 1992, 4:38 p.m.]

#### Original Notice.

Title of Rule: Restrictions and regulations for recreational equipment.

Purpose: To broaden the definition of recreational equipment which are limited or restricted in use on the campus.

Statutory Authority for Adoption: RCW 28B.35.120.

Summary: Policies originally applicable to bicycles and other traditional equipment, now include newer recreational equipment, such as roller blades. Policies have been generalized to pertain to "recreational equipment" rather than specific types of equipment.

Reasons Supporting Proposal: The university has had increasing safety and maintenance issues which have involved recreational equipment.

Name of Agency Personnel Responsible for Drafting: Vic Wallace, Lieutenant, Red Barn, (509) 359-6300; Implementation: Elson Floyd, Executive Vice-President, SHW 206, (509) 359-6293; and Enforcement: Elson Floyd or designee, SHW 206, (509) 359-6293.

Name of Proponent: Eastern Washington University, governmental.

Rule is not necessitated by federal law, federal or state court decision.

Explanation of Rule, its Purpose, and Anticipated Effects: Rules will clearly expand restrictions to include various types of recreational equipment, permitting enforcement of regulations and help in reducing destruction to university property and the potential of safety hazards.

Proposal Changes the Following Existing Rules: Definition of recreational equipment is more expansive.

No small business economic impact statement is required for this proposal by chapter 19.85 RCW.

Hearing Location: Eastern Washington University, Louise Anderson Hall, Cheney, Washington, on September 18, 1992, at 10:00 a.m.

Submit Written Comments to: Ann Carrasco, Rules Coordinator, SHW 318, Mailstop 114, Cheney, Washington 99004-2496, by September 17, 1992, 5:00 p.m.

Date of Intended Adoption: September 18, 1992.

July 17, 1992

Ann Carrasco

Rules Coordinator

#### Chapter 172-118 WAC

#### ~~((TRAFFIC AND PARKING))~~ RESTRICTIONS AND REGULATIONS FOR ~~((BICYCLES, MOTORCYCLES, AND MOTOR-SCOOTERS))~~ RECREATIONAL EQUIPMENT

#### AMENDATORY SECTION (Amending Order 72-12, filed 9/20/72)

WAC 172-118-010 PURPOSE. The primary objective of the rules and regulations set forth in this chapter ~~((is))~~ are:

(1) To provide safety, traffic, and parking controls for the use of skateboards, roller skates, bicycles, motorcycles, and ~~((motorscooters))~~ motor scooters upon all state lands devoted to the educational, recreational, research, and living activities of Eastern Washington ~~((State College))~~ University; and

(2) To protect, from physical damage and unnecessary wear, wooden and concrete benches, brick and paved walkways, stairs, steps, loading ramps, plazas, and ramps for the disabled, caused by the use of recreational equipment as included in subsection (1) of this section. Equipment for the disabled and equipment owned and operated by the university are exempt from this chapter.

#### AMENDATORY SECTION (Amending Order 72-12, filed 9/20/72)

WAC 172-118-020 ~~((BICYCLES, MOTORCYCLES, AND MOTORSCOOTERS DEFINED))~~ DEFINITIONS. ~~((A bicycle shall be, for the purposes of this section;))~~ For the purposes of this chapter the following definitions apply:

(1) A bicycle is any vehicle with three or less wheels and containing a saddle seat, and which is not motor driven.

(2) A motorcycle or motor scooter is any vehicle with three or less wheels and containing a saddle seat, and which is motor driven ~~((is considered a motorcycle or motorscooter for the purposes of this section)).~~

(3) A skateboard is a toy consisting of an oblong or rectangular board, made of wood, plastic, metal, or components thereof, with a pair of small wheels at each end, ridden as down an incline, usually in a standing position. It may be motorized.

(4) Roller skates are shoes with a set of wheels attached for skating over a flat surface, or a metal frame with wheels attached that can be fitted to the sole of the shoe. For the purposes of this chapter, roller blades are considered roller skates.

(5) A scooter is a foot-operated vehicle consisting of a narrow board mounted between two wheels, tandem with an upright steering handle attached to the front wheel.

Subsections (1) through (5) of this section are considered recreational equipment.

#### AMENDATORY SECTION (Amending Order 72-12, filed 9/20/72)

WAC 172-118-030 APPLICABLE RULES AND REGULATIONS. The safety, equipment, traffic, and parking regulations for bicycles, motorcycles, and ~~((motorscooters))~~ motor scooters which are applicable upon the campus of Eastern Washington ~~((State College))~~ University are as follows:

(1) The motor vehicle and other traffic laws of the state of Washington;

(2) The traffic code of the city of Cheney, Washington; and

(3) Special regulations set forth in this chapter.

#### AMENDATORY SECTION (Amending Order 74-2, filed 1/24/74)

WAC 172-118-040 ~~((OPERATION OF BICYCLES, MOTORCYCLES, AND MOTORSCOOTERS))~~ USE OF RECREATIONAL EQUIPMENT. (1) No ~~((bicycle, motorcycle, or motorscooter))~~ recreational equipment may be operated on sidewalks, walkways, lawns, or other property ~~((not set aside for such purposes))~~ on the Eastern Washington ~~((State College))~~ University campus ~~((; except that all bicycles, motorcycles, and motorscooters owned and operated~~

by the college shall be exempt from this provision)), except as provided in this chapter.

(2) Bicycles, motorcycles, and ~~((motorscooters))~~ motor scooters may be operated any place where automobiles or other motor vehicles are permitted.

(3) Bicycles, may be operated on ~~((college))~~ university walkways in the mall area and the area surrounding Showalter Hall and between ~~((the Hall of Sciences and the Memorial Field House))~~ Science Hall and Parking Lot #3: PROVIDED, That the bicycle is operated in a safe manner and in compliance with these regulations.

(4) Bicycle locks may be broken to facilitate impounding of ~~((said))~~ a bicycle or other recreational equipment without liability to Eastern ~~((State College))~~ Washington University or its authorized personnel. ~~((A two dollar impound fee must be paid before said bicycle is released to the owner.))~~

#### AMENDATORY SECTION (Amending Order 72-12, filed 9/20/72)

WAC 172-118-050 PARKING REGULATIONS. ~~((Bicycles,))~~ Motorcycles, and ~~((motorscooters))~~ motor scooters may be parked, without permit, in any parking lot on the campus of the ~~((college))~~ university, providing that ~~((said))~~ the parking does not interfere with the parking of motor vehicles.

(1) Bicycles must be parked in bicycle racks. At times, rack space may not be available and parking on the grass off the pavement will be permitted if all racks in the vicinity are full.

(2) ~~((Bicycles,))~~ Motorcycles, and ~~((motorscooters))~~ motor scooters may be parked in triangular spaces caused by angular parking in a lot.

(3) Bicycles, motorcycles, and ~~((motorscooters))~~ motor scooters may not be parked on any lawn, sidewalk, walkway, driveway, service area, against any building, building entrances or exits, nor in a building on the ~~((college))~~ university campus, except as provided in WAC 172-118-050(1).

(4) Bicycles, motorcycles, and ~~((motorscooters))~~ motor scooters not conforming to these regulations are subject to citation as are all other vehicles, and may be impounded as provided in WAC 172-116-230.

(5) Bicycle, motorcycle, and ~~((motorscooter))~~ motor scooter regulations will be in effect at all times.

#### AMENDATORY SECTION (Amending Order 72-12, filed 9/20/72)

WAC 172-118-080 REGISTRATION OF BICYCLES. All bicycles operated or parked ~~((upon))~~ on the campus of Eastern Washington ~~((State College))~~ University must be registered with the city of Cheney ~~((pursuant to its laws governing such registration)).~~

#### NEW SECTION

WAC 172-118-090 ENFORCEMENT. (1) Enforcement of this chapter is the responsibility of the president, or the executive vice-president, or their designees.

(2) A user of recreational equipment who refuses to abide by these regulations will be asked to leave the campus. Refusal to obey will subject the person to being cited for trespass under the provisions of chapter 9A.52 RCW.

(3) If the user is a student, the student will be asked to refrain from using the equipment on campus. If the student refuses, a proceeding may be initiated under the Student conduct code, chapter 172-120 WAC.

#### REPEALER

The following sections of the Washington Administrative Code are repealed:

WAC 172-118-060 UNAUTHORIZED USE.  
WAC 172-118-070 EQUIPMENT.

#### WSR 92-15-130

#### PROPOSED RULES

#### DEPARTMENT OF SOCIAL AND HEALTH SERVICES (Public Assistance)

[Filed July 21, 1992, 4:49 p.m.]

#### Original Notice.

Title of Rule: WAC 388-15-615 COPES—Program restrictions.

Purpose: COPES is a Medicaid waiver program approved for a three-year period by the Health Care Financing Administration (HCFA). Approval of the waiver requires the department to serve no more clients in nursing facilities and in home and community-based waiver services with COPES than would be served in nursing facilities without the waiver. Under this requirement, the department must restrict entry into the COPES program whenever the total number of unduplicated clients or the total federal funds expended for the waiver year is projected to exceed the amount approved by HCFA. Increases in the COPES caseload since March, 1992, have far exceeded projections. Because of these increases, the department is at risk of exceeding the unduplicated client caseload approved by HCFA. Exceeding the number of unduplicated clients puts the department at risk of federal sanctions which may include loss of federal matching funds or further program restrictions. To cover federal funding losses, the department would be required to use state funding from other programs, such as chore services. This would be detrimental to the health, safety and welfare to the chore services clients, who, in general, have less income and resources than COPES clients. The department proposes emergency rules which will limit the number of new applicants for COPES services. Clients presently on COPES will continue to receive services without restrictions. The proposed rules provide for access to the program for persons residing in hospitals or nursing facilities or who are eligible for department contracted assisted living services.

Statutory Authority for Adoption: RCW 74.09.500.

Statute Being Implemented: RCW 74.09.500.

Summary: These rules will limit access to the program. Clients presently on COPES will continue to receive services without restrictions. The rules provide for access to persons residing in hospitals or nursing facilities or who are eligible for department contracted assisted living. All other applicants will not be authorized services.

Reasons Supporting Proposal: Emergency WAC rules are required to immediately limit COPES caseload growth. These rules are necessary to comply with assurances given to HCFA in the application for participation in a home and community-based care waiver.

Name of Agency Personnel Responsible for Drafting, Implementation and Enforcement: Phil Wozniak, Aging and Adult Services, 493-2547.

Name of Proponent: Department of Social and Health Services, governmental.

Rule is not necessitated by federal law, federal or state court decision.

Explanation of Rule, its Purpose, and Anticipated Effects: Same as above.

Proposal Changes the Following Existing Rules: See above.

No small business economic impact statement is required for this proposal by chapter 19.85 RCW.

Hearing Location: OB-2 Auditorium, 12th and Franklin, Olympia, Washington, on August 25, 1992, at 10:00 a.m.

Submit Written Comments to: Troyce Warner, Chief, Office of Issuances, Mailstop 5805, Department of Social and Health Services, Olympia, 98504, TELEFAX 664-0118 or SCAN 366-0118, by August 25, 1992.

Date of Intended Adoption: August 27, 1992.

July 21, 1992

Leslie F. James, Director  
Administrative Services

#### NEW SECTION

WAC 388-15-615 COPEs—PROGRAM RESTRICTIONS. Effective July 20, 1992, the COPEs program shall be limited to persons eligible for COPEs services under WAC 388-15-610 and who:

- (1) Were in the COPEs program on July 20, 1992; or
- (2) Had submitted a written application for COPEs services with a Community Services Office or Aging and Adult Field Services Office as of July 20, 1992; or
- (3) Had received COPEs services on or after April 1, 1992; or
- (4) For each of the thirty days preceding the date of written application for COPEs services, have been either in a nursing facility as a resident or in a hospital as an inpatient; or
- (5) Are entering a department-contracted and an approved assisted living facility.

**WSR 92-15-131**  
**PROPOSED RULES**  
**DEPARTMENT OF**  
**SOCIAL AND HEALTH SERVICES**  
**(Public Assistance)**

[Filed July 21, 1992, 4:51 p.m.]

Original Notice.

Title of Rule: WAC 388-28-483 Prospective eligibility, prospective budgeting, and retrospective budgeting.

Purpose: The AFDC prospective eligibility, prospective budgeting, and retrospective budgeting rules are modified to require the same income budgeting practices as required by the food stamp program. This implements changes required by state plan amendment.

Statutory Authority for Adoption: RCW 74.04.057.

Statute Being Implemented: RCW 74.04.057.

Summary: Revise AFDC prospective budgeting and retrospective budgeting rules to require the same income budgeting policies as required by the food stamp program.

Reasons Supporting Proposal: To incorporate changes required by state plan amendment.

Name of Agency Personnel Responsible for Drafting, Implementation and Enforcement: Steve Ebben, Division of Income Assistance, 438-8311.

Name of Proponent: Department of Social and Health Services, governmental.

Rule is not necessitated by federal law, federal or state court decision.

Explanation of Rule, its Purpose, and Anticipated Effects: Same as above.

Proposal Changes the Following Existing Rules: See above.

No small business economic impact statement is required for this proposal by chapter 19.85 RCW.

Hearing Location: OB-2 Auditorium, 12th and Franklin, Olympia, Washington, on August 25, 1992, at 10:00 a.m.

Submit Written Comments to: Troyce Warner, Chief, Office of Issuances, Mailstop 5805, Department of Social and Health Services, Olympia, 98504, TELEFAX 664-0118 or SCAN 366-0118, by August 25, 1992.

Date of Intended Adoption: August 27, 1992.

July 21, 1992

Leslie F. James, Director  
Administrative Services

#### AMENDATORY SECTION (Amending Order 2861, filed 8/29/89, effective 9/29/89)

WAC 388-28-483 PROSPECTIVE ELIGIBILITY, PROSPECTIVE BUDGETING, AND RETROSPECTIVE BUDGETING. (1) Definitions. The department shall call the:

(a) Calendar month for which payment is made, the payment month.

(b) Second calendar month preceding the payment month, the budget month.

(c) Calendar month between the budget month and the payment month, the process month.

(2) Eligibility determination. The department shall determine eligibility based on the best estimate of income and circumstances existing in the payment month.

(3) Prospective budgeting.

(a) Except as specified under subsections (3)((d))(e) and (4)(a) of this section, the department shall budget all income prospectively for the first two months of initial eligibility, including income of an individual added to an existing assistance unit.

(b) The department shall budget income prospectively for:

(i) Migrant assistance units as defined in WAC 388-24-044(2);

(ii) Homeless assistance units as defined in WAC 388-24-044(2);

(iii) Assistance units in which all adult members are elderly or disabled, as defined in WAC 388-24-044(3), and do not have:

(A) Earned income; or

(B) Recent work history as defined in WAC 388-24-044(3).

(c) The department shall compute the amount of the assistance payment based on the expected income and circumstances existing in the payment month.

((e)) (d) The department shall:

(i) Establish an overpayment if the income is underestimated; and

(ii) Issue a corrective payment if the income is overestimated.

((d)) (e) The department shall budget income prospectively for one month if the case has been closed less than one month and the case was closed in the first prospective month.

(4) Retrospective budgeting.

(a) The department shall retrospectively budget all income for the first two months of initial eligibility if one of the following exist:

(i) A case is reopened as terminated in error;

(ii) An individual having had income ((~~deemed~~)) allocated to an assistance unit is added to that assistance unit;

(iii) Assistance had been suspended as specified under subsection (5) of this section and:

(A) The initial month follows the month of suspension; and

(B) The family's circumstances for the initial authorization month have not changed significantly from the circumstances reported in the budget month.

(iv) A case is reopened that has been closed less than one month and was closed in the second prospective month; ((~~and~~)) or

(v) A case is reopened that has been closed less than one month and was closed in a retrospective month.

(b) After the first two months of initial eligibility, the department shall budget ((~~and~~)) income retrospectively for all assistance units, except as specified under subsections (3)(b) and (4)(e) of this section.



(c) The department shall compute the amount of assistance based on the income or circumstances existing in the budget month.

(d) The department shall consider all income received during the calendar month of application approval for retrospective budgeting purposes, except as specified under subsection (4)(e) of this section.

(e) Noncontinuous income budgeted prospectively during the first two months of eligibility shall not be budgeted for the first and second payment month for which retrospective budgeting is used.

(5) See WAC 388-33-135 for effective dates of ineligibility. Suspension. The department shall suspend rather than terminate if:

(a) The department has knowledge of or reason to believe ineligibility would be only for one payment month; and

(b) Ineligibility for that one payment month was caused by income or other circumstances in the corresponding budget month.

**Reviser's note:** The typographical error in the above section occurred in the copy filed by the agency and appears in the Register pursuant to the requirements of RCW 34.08.040.

**WSR 92-15-132**  
**EMERGENCY RULES**  
**DEPARTMENT OF**  
**SOCIAL AND HEALTH SERVICES**  
**(Public Assistance)**

[Filed July 21, 1992, 4:54 p.m., effective July 22, 1992, 12:01 a.m.]

Date of Adoption: July 21, 1992.

Purpose: The AFDC prospective eligibility, prospective budgeting, and retrospective budgeting rules are modified to require the same income budgeting practices as required by the food stamp program. This implements changes required by state plan amendment.

Citation of Existing Rules Affected by this Order: Amending WAC 388-28-483 Prospective eligibility, prospective budgeting, and retrospective budgeting.

Statutory Authority for Adoption: RCW 74.04.057.

Pursuant to RCW 34.05.350 the agency for good cause finds that immediate adoption, amendment, or repeal of a rule is necessary for the preservation of the public health, safety, or general welfare, and that observing the time requirements of notice and opportunity to comment upon adoption of a permanent rule would be contrary to the public interest.

Reasons for this Finding: To incorporate changes required by state plan amendment. This is the result of an approved federal waiver to enhance compatibility between the AFDC program and the food stamp program.

Effective Date of Rule: 12:01 a.m., July 22, 1992.

July 21, 1992

Leslie F. James, Director  
Administrative Services

**AMENDATORY SECTION (Amending Order 2861, filed 8/29/89, effective 9/29/89)**

**WAC 388-28-483 PROSPECTIVE ELIGIBILITY, PROSPECTIVE BUDGETING, AND RETROSPECTIVE BUDGETING.** (1) *Definitions.* The department shall call the:

(a) *Calendar month for which payment is made, the payment month.*

(b) *Second calendar month preceding the payment month, the budget month.*

(c) *Calendar month between the budget month and the payment month, the process month.*

(2) *Eligibility determination.* The department shall determine eligibility based on the best estimate of income and circumstances existing in the payment month.

(3) *Prospective budgeting.*

(a) *Except as specified under subsections (3)(d)(e) and (4)(a) of this section, the department shall budget all income prospectively for the first two months of initial eligibility, including income of an individual added to an existing assistance unit.*

(b) *The department shall budget income prospectively for:*

(i) Migrant assistance units as defined in WAC 388-24-044(2);

(ii) Homeless assistance units as defined in WAC 388-24-044(2);

(iii) Assistance units in which all adult members are elderly or disabled, as defined in WAC 388-24-044(3), and do not have:

(A) Earned income; or

(B) Recent work history as defined in WAC 388-24-044(3).

(c) The department shall compute the amount of the assistance payment based on the expected income and circumstances existing in the payment month.

~~((f))~~ (d) *The department shall:*

(i) *Establish an overpayment if the income is underestimated; and*

(ii) *Issue a corrective payment if the income is overestimated.*

~~((t))~~ (e) *The department shall budget income prospectively for one month if the case has been closed less than one month and the case was closed in the first prospective month.*

(4) *Retrospective budgeting.*

(a) *The department shall retrospectively budget all income for the first two months of initial eligibility if one of the following exist:*

(i) *A case is reopened as terminated in error;*

(ii) *An individual having had income ~~((deemed))~~ allocated to an assistance unit is added to that assistance unit;*

(iii) *Assistance had been suspended as specified under subsection (5) of this section and:*

(A) *The initial month follows the month of suspension; and*

(B) *The family's circumstances for the initial authorization month have not changed significantly from the circumstances reported in the budget month.*

(iv) *A case is reopened that has been closed less than one month and was closed in the second prospective month; ~~((and))~~ or*

(v) *A case is reopened that has been closed less than one month and was closed in a retrospective month.*

(b) *After the first two months of initial eligibility, the department shall budget ~~((aH))~~ income retrospectively for all assistance units, except as specified under subsections (3)(b) and (4)(e) of this section.*

(c) *The department shall compute the amount of assistance based on the income or circumstances existing in the budget month.*

(d) *The department shall consider all income received during the calendar month of application approval for*

retrospective budgeting purposes, except as specified under subsection (4)(e) of this section.

(e) Noncontinuous income budgeted prospectively during the first two months of eligibility shall not be budgeted for the first and second payment month for which retrospective budgeting is used.

(5) See WAC 388-33-135 for effective dates of ineligibility. Suspension. The department shall suspend rather than terminate if:

(a) The department has knowledge of or reason to believe ineligibility would be only for one payment month; and

(b) Ineligibility for that one payment month was caused by income or other circumstances in the corresponding budget month.

Reviser's note: The typographical error in the above section occurred in the copy filed by the agency and appears in the Register pursuant to the requirements of RCW 34.08.040.

**WSR 92-15-133**  
**RULES COORDINATOR**  
**CENTRAL PUGET SOUND**  
**GROWTH PLANNING HEARINGS BOARD**  
[Filed July 22, 1992, 8:07 a.m.]

Now that the Central Puget Sound Growth Planning Hearings Board has moved into its permanent office location, the rules coordinator for the Growth Planning Hearings Boards has changed. Pursuant to RCW 34.05.310(3), I will now be the rules coordinator for the three Growth Planning Hearings Boards. Please contact me at 2329 One Union Square, 600 University Street, Seattle, WA 98101, (206) 389-2625, FAX (206) 389-2588.

M. Peter Philley  
Board Member

**WSR 92-15-134**  
**PROPOSED RULES**  
**GROWTH PLANNING HEARINGS BOARDS**  
[Filed July 22, 1992, 8:11 a.m.]

Original Notice.

Title of Rule: Title 242 WAC.

Purpose: To establish the joint rules of practice and procedure for the three Growth Planning Hearings Boards. The rules include a chapter on compliance with the public records provisions of the Public Disclosure Act and a chapter on SEPA compliance.

Other Identifying Information: Each of the three hearings boards will use the same rules; they will be jointly adopted.

Statutory Authority for Adoption: RCW 36.70A.270(6).

Statute Being Implemented: Chapter 36.70A RCW.

Summary: The boards jointly adopted emergency rules of practice and procedure on June 16, 1992. These

rules will be the permanent replacement for the emergency rules.

Reasons Supporting Proposal: The emergency rules automatically expire on October 16, 1992. Written comments have subsequently been received and incorporated into the proposed permanent rules.

Name of Agency Personnel Responsible for Drafting, Implementation and Enforcement: M. Peter Philley, 2329 One Union Square, 600 University Street, Seattle, WA 98101, (206) 389-2625.

Name of Proponent: Washington State Growth Planning Hearings Boards, governmental.

Rule is not necessitated by federal law, federal or state court decision.

Explanation of Rule, its Purpose, and Anticipated Effects: These rules provide guidance for anyone interested in appearing before a growth planning hearings board. They were mandated by RCW 36.70A.270(6) to be formulated jointly by the three boards.

Proposal Changes the Following Existing Rules: The proposed permanent rules slightly change the existing emergency rules. Written comments about the emergency rules were received and reviewed. Changes have resulted from those comments. The rules on service of process and pleadings have been streamlined and minor editing changes have been made.

No small business economic impact statement is required for this proposal by chapter 19.85 RCW.

The Growth Planning Hearings Boards have reviewed chapter 19.85 RCW, the Regulatory Fairness Act, and concluded that the adoption of the boards' joint rules on practice and procedure will not have an economic impact on any industry. In addition, the rules are being adopted solely for the purpose of compliance with RCW 36.70-.270. The rules are procedural in nature, not substantive.

Hearing Locations: On September 23, 1992, at 10:00 a.m., Central Puget Sound Growth Planning Hearings Board, 1225 One Union Square, 600 University Street, Seattle, WA 98101; on October 6, 1992, at 1:30 p.m., Eastern Washington Growth Planning Hearings Board, Yakima County Courthouse, Room 420, 128 North Second Street, Yakima, WA 98901; and on September 23, 1992, 1:30 p.m., Western Washington Growth Planning Hearings Board, Room 104-A, Lacey Governmental Center, 1009 College Street S.E., Lacey, WA 98504-0953.

Submit Written Comments to: Central Puget South Growth Planning Hearings Board, 2329 One Union Square, 600 University Street, Seattle, WA 98101, by October 7, 1992.

Date of Intended Adoption: October 14, 1992.

July 21, 1992  
M. Peter Philley  
Board Member

Reviser's note: The material contained in this filing will appear in the 92-17 issue of the Register as it was received after the applicable closing date for the issue for agency-typed material exceeding the volume limitations of WAC 1-21-040.

**WSR 92-15-135**  
**PROPOSED RULES**  
**HIGHER EDUCATION**  
**COORDINATING BOARD**  
[Filed July 22, 1992, 8:19 a.m.]

Continuance of WSR 92-13-076.

Title of Rule: Washington state scholars program, WAC 250-66-010 through 250-66-060.

Purpose: To amend existing rules and regulations to reflect changes to statute as effected by the 1992 legislature through ESB 6285.

Statutory Authority for Adoption: Chapter 28B.80 RCW and ESB 6285, chapter 231, Laws of 1992.

Statute Being Implemented: ESB 6285, chapter 231, Laws of 1992.

Date of Intended Adoption: July 29, 1992.

July 22, 1992  
Ann Daley  
Executive Director

**WSR 92-15-136**  
**PROPOSED RULES**  
**HIGHER EDUCATION**  
**COORDINATING BOARD**  
[Filed July 22, 1992, 8:23 a.m.]

Continuance of WSR 92-13-077.

Title of Rule: Washington award for excellence in education (also known as the Washington State Christa McAuliffe Academic Grant Award), WAC 250-78-010 through 250-78-060.

Purpose: To implement ESSB 6326, technical amendments to the academic grant program, and SSB 6327, incorporating classified employees selected after June 30, 1993, as eligible recipients of the academic grant award option.

Statutory Authority for Adoption: Chapters 28B.80 and 28A.625 RCW, ESSB 6326 and SSB 6327.

Statute Being Implemented: ESSB 6326 and SSB 6327.

Date of Intended Adoption: July 29, 1992.

July 22, 1992  
Ann Daley  
Executive Director

**WSR 92-15-137**  
**PROPOSED RULES**  
**DEPARTMENT OF**  
**NATURAL RESOURCES**  
[Order 604—Filed July 22, 1992, 8:32 a.m.]

Original Notice.

Title of Rule: Chapter 332-08 WAC, Adjudicative proceedings before the Department of Natural Resources.

Purpose: To conform the Department of Natural Resources' rules on adjudicative proceedings to department practice and state mail procedures.

Statutory Authority for Adoption: RCW 34.05.220 (1)(a).

Statute Being Implemented: Chapter 34.05 RCW.

Summary: The proposal changes filing addresses and adds provisions relating to adjudicative proceedings under RCW 78.44.030(3).

Reasons Supporting Proposal: The Department of Natural Resources' current procedural rules do not fully reflect department practice under the Administrative Procedure Act, chapter 34.05 RCW.

Name of Agency Personnel Responsible for Drafting: Fronda Woods, Assistant Attorney General, Highways-Building, P.O. Box 40100, Olympia, WA 98504-0100, (206) 586-3692; Implementation and Enforcement: James A. Stearns, Supervisor, Department of Natural Resources, 201 Cherberg Building, Olympia, WA, 753-5331.

Name of Proponent: Department of Natural Resources, governmental.

Rule is not necessitated by federal law, federal or state court decision.

Explanation of Rule, its Purpose, and Anticipated Effects: The proposal would update filing addresses to conform to the current state mail system and would specify a burden of proof in adjudicative proceedings concerning declarations of abandonment of surface mining operations.

Proposal Changes the Following Existing Rules: The proposal would change the filing addresses given in WAC 332-08-125, 332-08-405, 332-08-515(2), and 332-08-545(2).

No small business economic impact statement is required for this proposal by chapter 19.85 RCW.

Hearing Location: Large Conference Room, Airdustrial Building #2, 7211 Cleanwater Lane, Tumwater, WA 98501, on August 27, 1992, at 9:00 a.m.

Submit Written Comments to: Dave Dietzman, SEPA Center, P.O. Box 47014, Olympia, WA 98504-7014, by August 27, 1992.

Date of Intended Adoption: August 28, 1992.

July 17, 1992  
Stan Biles  
Acting  
for James A. Stearns  
Department Supervisor

AMENDATORY SECTION (Amending Order 91-587 [587], filed 12/6/91)

WAC 332-08-125 APPLICATION FOR ADJUDICATIVE PROCEEDING — PLACE OF FILING. (1) An application for adjudicative proceeding concerning surface mining operations under chapter 78.44 RCW must be filed at the following address:

ATTN: Regulatory Programs Manager  
Division of Geology and Earth Resources  
Department of Natural Resources  
(4224 S.E. 6th Avenue, Rowesix Bldg. +  
Eacey, WA 98503)  
P.O. Box 47007  
Olympia, WA 98504-7007

(2) An application for adjudicative proceeding concerning the revocation of permission to install and maintain a private recreational dock under RCW 79.90.105 and WAC 332-30-144 must be filed at the following address:

Division Manager  
 Division of Aquatic Lands  
 Department of Natural Resources  
 ((202 John A. Cherberg Bldg., Mailstop QW-21))  
 P.O. Box 47027  
 Olympia, WA 98504-7027

(3) Applications for adjudicative proceedings concerning notices to comply issued under RCW 76.09.090 and WAC 222-46-030 (forest practices), performance bond permit adjustments under RCW 78.44-120 (surface mining), and notices of deficiency issued under RCW 78.44.140 (surface mining) are governed by WAC 332-08-515.

(4) Applications for adjudicative proceedings in all other cases must be filed at the following address:

Office of the Supervisor  
 Department of Natural Resources  
 ((201 John A. Cherberg Bldg., Mailstop QW-21))  
 P.O. Box 47001  
 Olympia, WA 98504-7001

**Reviser's note:** The bracketed material preceding the section above was supplied by the code reviser's office.

**AMENDATORY SECTION** (Amending Order 91-587 [587], filed 12/6/91)

WAC 332-08-315 **BURDEN OF PROOF.** (1) Unless otherwise ordered by the presiding officer or required by law, the burden of proof in adjudicative proceedings pursuant to RCW 34.05.413 through RCW 34.05.476 shall be as follows:

(a) In proceedings concerning the denial of an application for a surface mining permit or disapproval of a reclamation plan under RCW 78.44.100, the applicant has the burden of proof.

(b) In proceedings concerning the modification of a reclamation plan under RCW 78.44.100, the department has the burden of proof.

(c) In proceedings concerning a permit cancellation under RCW 78.44.140, the department has the burden of proof.

(d) In civil penalty proceedings and proceedings concerning stop work orders under RCW 78.44.160, the department has the burden of proof.

(e) In proceedings concerning a declaration of abandonment under RCW 78.44.030(3), the department has the burden of proof.

(f) In proceedings concerning the revocation of permission to install and maintain a private recreational dock under RCW 79.90.105 and WAC 332-30-144, the department has the burden of proof.

((f)) (g) In all other cases, the proponent of an order has the burden of proof.

(2) Unless otherwise ordered by the presiding officer or required by law, the standard of proof in adjudicative proceedings pursuant to RCW 34.05.413 through RCW 34.05.476 shall be a preponderance of the evidence.

**Reviser's note:** The bracketed material preceding the section above was supplied by the code reviser's office.

**AMENDATORY SECTION** (Amending Order 91-573 [573], filed 6/17/91)

WAC 332-08-405 **PETITIONS FOR REVIEW OF INITIAL ORDERS — FINAL ORDERS.** (1) Except in brief adjudicative proceedings, initial orders in all adjudicative proceedings before the department will become final without further action by the department unless, within twenty days of the date of service of the initial order, a petition for review is filed at the address given below:

Office of the Supervisor  
 Department of Natural Resources  
 ((201 John A. Cherberg Bldg., Mailstop QW-21))  
 P.O. Box 47001  
 Olympia, WA 98504-7001

The provisions of WAC 10-08-211 apply to petitions for review of initial orders.

(2) WAC 332-08-545 governs review of orders in brief adjudicative proceedings.

**Reviser's note:** The bracketed material preceding the section above was supplied by the code reviser's office.

**AMENDATORY SECTION** (Amending Order 91-587 [587], filed 12/6/91)

WAC 332-08-515 **BRIEF ADJUDICATIVE PROCEEDINGS—APPLICATION PROCEDURE.** (1) An application for a BAP must be in writing, and must specify the factual basis for appeal and the issue to be adjudicated in the proceeding.

(2) An application for a BAP concerning a notice to comply issued under RCW 76.09.090 and WAC 222-46-030 must be filed within fifteen days after the date of service of the notice to comply. The application must be filed at the following address:

Office of the Supervisor  
 Department of Natural Resources  
 ((201 John A. Cherberg Bldg., Mailstop QW-21))  
 P.O. Box 47001  
 Olympia, WA 98504-7001

(3) An application for a BAP concerning a performance bond permit adjustment under RCW 78.44.120 must be filed within fifteen days after service of the notice adjusting the performance bond amount specified in the operating permit. The application must be filed with the department's region office that issued the notice. A list of the department's region offices and their addresses appears in WAC 332-10-030. The application should be addressed to the attention of the surface mining contact person. Upon receiving an application for a BAP concerning a performance bond permit adjustment, the department may choose to use the formal procedures of RCW 34.05.413 through RCW 34.05.476 and WAC 332-08-005 through WAC 332-08-405, and may choose not to use BAP procedures.

(4) An application for a BAP concerning a notice of deficiency issued under RCW 78.44.140 must be filed within fifteen days after service of the notice of deficiency. The application must be filed with the department's region office that issued the notice. A list of the department's region offices and their addresses appears in WAC 332-10-030. The application should be addressed to the attention of the surface mining contact person. Upon receiving an application for a BAP concerning a notice of deficiency, the department may choose to use the formal procedures of RCW 34.05.413 through RCW 34.05.476 and WAC 332-08-005 through WAC 332-08-405, and may choose not to use BAP procedures.

**Reviser's note:** The bracketed material preceding the section above was supplied by the code reviser's office.

**AMENDATORY SECTION** (Amending Order 91-573 [573], filed 6/17/91)

WAC 332-08-545 **BRIEF ADJUDICATIVE PROCEEDINGS—REVIEW.** (1) The operator, forest land owner, or timber owner subject to a final order of the department on a notice to comply issued under RCW 76.09.090 and WAC 222-46-030 may, within thirty days from the date of the order, appeal to the forest practices appeals board. The provisions of chapter 223-08 WAC govern such appeals.

(2) In all other brief adjudicative proceedings, a party affected by an initial order of the department may request administrative review of the initial order. A request for administrative review must be writing, and must be filed at the following address within twenty-one days after the date of service of the initial order:

Office of the Supervisor  
 Department of Natural Resources  
 ((201 John A. Cherberg Bldg., Mailstop QW-21))  
 P.O. Box 47001  
 Olympia, WA 98504-7001

The initial order becomes a final order if no review is taken.

**Reviser's note:** The bracketed material preceding the section above was supplied by the code reviser's office.

WSR 92-15-138
PROPOSED RULES
DEPARTMENT OF
NATURAL RESOURCES
[Order 605-Filed July 22, 1992, 8:37 a.m.]

Date of Intended Adoption: August 28, 1992.

July 17, 1992
Stan Biles
Acting
for James A. Stearns
Supervisor

Original Notice.

Title of Rule: WAC 332-18-120, Bonds and 332-18-130, Bank letters of credit.

Purpose: To describe performance securities that the Department of Natural Resources will accept under RCW 78.44.120 to secure surface mine operators' reclamation obligations.

Statutory Authority for Adoption: RCW 78.44.040.

Statute Being Implemented: RCW 78.44.120.

Summary: The proposal would amend WAC 332-18-120 to conform to section 1, chapter 215, Laws of 1984, and would add WAC 332-18-130 to describe bank letters of credit acceptable to the Department of Natural Resources under RCW 78.44.120.

Reasons Supporting Proposal: The current version of WAC 332-18-120 is outmoded and is inconsistent with RCW 78.44.120.

Name of Agency Personnel Responsible for Drafting: Fronda Woods, Assistant Attorney General, Highways-Licenses Building, Olympia, WA, (206) 586-3692; Implementation: Ray Lasmanis, Geology and Earth Resources, Division Manager, Lacey, WA, (206) 459-6372; and Enforcement: Ted Price, Deputy Supervisor, John A. Cherberg Building, Olympia, WA, (206) 753-5308.

Name of Proponent: Department of Natural Resources, governmental.

Rule is not necessitated by federal law, federal or state court decision.

Explanation of Rule, its Purpose, and Anticipated Effects: The proposal would describe bonds and bank letters of credit acceptable to the Department of Natural Resources under RCW 78.44.120 to secure reclamation of surface-mined land. The proposal would amend WAC 332-18-120 to clarify its language and to change the secured party from the Board of Natural Resources to the Department of Natural Resources in accordance with section 1, chapter 215, Laws of 1984. Proposed WAC 332-18-130 describes bank letters of credit that the Department of Natural Resources will accept under RCW 78.44.120.

Proposal Changes the Following Existing Rules: The proposal would amend WAC 332-18-120 to clarify its language and to change the secured party from the Board of Natural Resources to the Department of Natural Resources.

No small business economic impact statement is required for this proposal by chapter 19.85 RCW.

Hearing Location: Large Conference Room, Airdustrial Building #2, 7211 Cleanwater Lane, Tumwater, WA 98501, on August 27, 1992, at 9:00 a.m.

Submit Written Comments to: Dave Dietzman, SEPA Center, P.O. Box 47014, Olympia, WA 98504-7014, by August 27, 1992.

AMENDATORY SECTION (Amending Order 70-86 [86], filed 10/27/70)

WAC 332-18-120 BONDS. (1) Performance bonds required by ((section 13 of the act)) RCW 78.44.120 shall be substantially in the following form, ((provided however that)) unless the department ((may)), in considering any permit, ((require)) determines that a different form ((when in their opinion such)) is desirable or required.

SURFACE MINING RECLAMATION BOND

Permit No. ....

KNOW ALL MEN BY THESE PRESENTS, That we, ....., as Principal, and ..... a corporation organized and existing under the laws of the State of ..... and ((duty)) authorized to transact business in the State of Washington, as Surety, are held and firmly bound unto the State of Washington, acting through the ((Board)) Department of Natural Resources, in the sum of ..... (\$.....) U.S. DOLLARS, for the payment of which sum ((well and truly to be made,)) we bind ourselves, and each of our legal representatives, executors, administrators, successors and assigns, jointly and severally, firmly by these presents.

WHEREAS, The Principal has received from the ((Board)) Department of Natural Resources, State of Washington, a permit to conduct surface mining on the ((following described premises)) Premises whose legal description is ((to-wit)): .....

NOW, THEREFORE, The conditions of this obligation are such that if the ((above bounden)) Principal ((shall)), in conducting such surface mining operations, faithfully performs the requirements of the permit and chapter ((64; Laws of 1970 ex. sess.)) 78.44 RCW, relating to mining and the reclamation of surface-mined land and the Rules and Regulations adopted ((pursuant thereto)) thereunder, then this obligation shall be exonerated and discharged and become null and void; otherwise to remain in full force and effect. In accordance with section 78.44.120 of the Revised Code of Washington, this bond secures completion of reclamation for the area to be surface mined after the signature date of this bond and any previously surface mined area on the Premises on which reclamation has not been satisfactorily completed and approved.

PROVIDED, However, the Surety shall not be liable under this bond for an amount greater in the aggregate than the sum designated in the first paragraph hereof ((and)); The Surety shall not be liable ((as respects any obligations related to)) for surface mining ((operations)) performed on the Premises after ((the expiration of thirty)) a date sixty days ((from the date of the mailing by)) after the Surety ((of)) mails a cancellation notice ((directed)) to the Principal and the ((Board)) Department of Natural Resources, Olympia, Washington. The bond shall remain in full force and effect as respects obligations related to surface mining ((operations)) performed on the Premises ((prior to the effective)) before that date ((of such cancellation)) unless the Principal files a substitute bond, approved by the ((Board)) Department of Natural Resources, or unless the ((Board)) Department of Natural Resources ((shall)) otherwise releases the Surety in writing.

Signed, sealed and dated this ..... day of ....., ((197))...

(2) Bonds submitted under RCW 78.44.120 shall contain a legal description of the area for which a surface mine operating permit has been issued. An acceptable legal description for bonds takes this form:

"a portion of the NE1/4 of sec. 15 T2N R3E." The department will generally not accept metes and bounds descriptions.

**Reviser's note:** The bracketed material preceding the section above was supplied by the code reviser's office.

**Reviser's note:** RCW 34.05.395 requires the use of underlining and deletion marks to indicate amendments to existing rules. The rule published above varies from its predecessor in certain respects not indicated by the use of these markings.

#### NEW SECTION

WAC 332-18-130 BANK LETTERS OF CREDIT. The department may accept a bank letter of credit in lieu of the performance bond required by RCW 78.44.120.

(1) The department will accept a bank letter of credit under RCW 78.44.120 only if the letters of credit is established in an amount equal to the estimated cost of completing the reclamation plan for the area to be surface mined during the next twelve-month period and any previously surface-mined area for which a permit has been issued and on which the reclamation has not been satisfactorily completed and approved.

(2) If the letter of credit is issued by a bank that has an office within the state of Washington, the department will accept the letter of credit if it:

(a) Is issued by a bank that is financially sound and is authorized to do business in state of Washington;

(b) Does not state that it is subject to the uniform customs and practice for documentary credits; and

(c) Is in the form described in subsection (4) of this section.

(3) If the letter of credit is issued by a bank that does not have an office within the state of Washington, the department will accept the letter of credit if it:

(a) Is in the form described in subsection (4) of this section; and

(b) Is accompanied by a letter of confirmation that:

(i) Is issued by a bank that is financially sound, is authorized to do business in the state of Washington, and has an office within the state of Washington;

(ii) States that the confirming bank will honor the letter of credit; and

(iii) States that the letter of confirmation is subject to the uniform customs and practice for documentary credits, 1983 revision, ICC publication no. 400.

(4) Unless the department determines that a different form is desirable or required, any letter of credit filed with the department under RCW 78.44.120 shall:

(a) Be in writing;

(b) Be signed by the issuer;

(c) Conspicuously state that it is a letter of credit and is issued on behalf of the person whose performance it is intended to secure;

(d) Identify the Department of Natural Resources, State of Washington, as the sole beneficiary;

(e) State that it is irrevocable;

(f) State the date upon which it will expire and provide that the expiration date will be automatically extended for one year from that date or any future expiration date unless, no later than sixty (60) days before any expiration date, the issuing bank notifies the department in writing by registered mail of the bank's election not to renew; and shall

(g) Expressly provide that any draft or demand for payment must be accompanied by the department's signed statement that the person whose performance the credit is intended to secure is in default of the obligations imposed by Chapter 78.44 RCW.

**WSR 92-15-139**  
**PERMANENT RULES**  
**BOARD OF REGISTRATION**  
**FOR PROFESSIONAL ENGINEERS**  
**AND LAND SURVEYORS**

[Filed July 22, 1992, 8:44 a.m.]

Date of Adoption: July 17, 1992.

**Purpose:** To correct the name of the National Council of Examiners for Engineers and Land Surveyors and expand exam review times, options and criteria. This will provide greater flexibility in scheduling exam reviews and give a larger number of examinees the opportunity to review their exam.

**Citation of Existing Rules Affected by this Order:**  
Amending WAC 196-24-105.

**Statutory Authority for Adoption:** RCW 18.43.035.

**Pursuant to notice filed as WSR 92-12-053 on May 29, 1992.**

**Effective Date of Rule:** Thirty-one days after filing.

July 22, 1992

Alan E. Rathbun, PE

Executive Director

#### AMENDATORY SECTION (Amending Order PM 606, filed 6/4/87)

WAC 196-24-105 EXAMINATION REVIEW. The following conditions shall apply to all examinations administered by the board:

First time examinees shall not be allowed to view any examination material prior to taking the examination other than syllabi available to the public or sample examination booklets published by the National Council of ((Engineering)) Examiners for Engineering and Surveying.

Examinees who achieve a passing score will not be permitted to review their examination.

Failing examinees may review their examination (test booklet, answer sheet or solution pamphlet and answer key) during a period of up to ninety days ((from the date of the examination result letter)) as prescribed by the board. Examinees shall review their examinations only during the prescribed time period. Examinees who fail to review their exam during the prescribed time will not be scheduled for an examination review. This review shall be under the following conditions:

(1) An examinee shall be able to review his/her examination one time only. This review shall be arranged in advance by appointment with office staff.

(2) All examination reviews shall be conducted in the presence of a member of the office staff. No one may accompany the examinee during the examination review except where persons with disability require assistance, and that need is conveyed to staff when the exam review appointment is made.

(3) In regard to any examinations consisting of machine scored answer sheets, the examinee shall be allowed to review a copy of his/her answer sheet.

(4) Note taking shall be limited to examination scoring and general problem subject matter. No detailed notes depicting any portion of an examination question or solution will be permitted.

(5) Board of registration staff shall supply the examinee with writing materials for taking notes.

(6) All notes must be reviewed by board staff prior to the examinee leaving the office.

(7) All examination appeals shall be conducted in conformance with the policies and procedures adopted by the board. Any questions pertaining to an appeal of

examination scoring shall be directed to supervisory staff.

**WSR 92-15-140**  
**PROPOSED RULES**  
**SECRETARY OF STATE**  
 [Filed July 22, 1992, 9:00 a.m.]

**Original Notice.**

**Title of Rule:** Procedures regarding telephone absentee requests.

**Purpose:** To provide procedures to be followed by county auditors in processing telephone requests for absentee ballots.

**Statutory Authority for Adoption:** RCW 29.36.010.

**Statute Being Implemented:** RCW 29.36.010.

**Summary:** This rule authorizes county auditors to ask for supplemental information when receiving a telephone request for an absentee.

**Reasons Supporting Proposal:** Provide additional integrity for the absentee ballot process.

**Name of Agency Personnel Responsible for Drafting:** John Pearson, Olympia, 753-2336; **Implementation and Enforcement:** Ralph Munro, Olympia, 753-7121.

**Name of Proponent:** Office of the Secretary of State, public.

Rule is not necessitated by federal law, federal or state court decision.

**Explanation of Rule, its Purpose, and Anticipated Effects:** Rule authorizes auditors to ask for date of birth information from persons requesting absentee ballots by telephone. This will help insure that only requests for immediate family members are made.

Proposal does not change existing rules.

No small business economic impact statement is required for this proposal by chapter 19.85 RCW.

**Hearing Location:** Office of the Secretary of State, on August 26, 1992, at 11:00 a.m.

**Submit Written Comments to:** Ralph Munro, Secretary of State, P.O. Box 40229, Olympia, by August 19, 1992.

**Date of Intended Adoption:** August 26, 1992.

July 22, 1992

Gary McIntosh

Director of Elections

**NEW SECTION**

**WAC 434-40-025 TELEPHONE REQUESTS FOR ABSENTEE BALLOTS.** Any registered voter may, by telephone, request an absentee ballot for his or her use and for any member of his or her immediate family. Whenever a request for an absentee ballot is made by telephone, the county auditor shall record the date on which the request was made and the name of the person making the request. The county auditor may, at his or her discretion, require the person making the request to identify the relationship with, and the date of birth of, each person for whom such a request is made. The county auditor may refuse to issue an absentee ballot in those instances where the person is either unable or unwilling to provide the date of birth information. The auditor shall inform the person making the request that those persons for whom a telephone request has been denied may request an absentee ballot by mail.

**WSR 92-15-141**  
**PROPOSED RULES**  
**SECRETARY OF STATE**  
 [Filed July 22, 1992, 9:04 a.m.]

**Original Notice.**

**Title of Rule:** Implement state law regarding the faxing of election documents.

**Purpose:** To provide guidelines regarding the procedures to be followed when filing officers receive certain election documents.

**Statutory Authority for Adoption:** RCW 29.04.230.

**Statute Being Implemented:** RCW 20.04.230 [29.04.230].

**Summary:** These rules provide a listing of certain documents which may be filed by electronic facsimile transmission and also provide a time period for the original document to be filed.

**Reasons Supporting Proposal:** Rules provide needed additional guidance for election officials in this area of new technology.

**Name of Agency Personnel Responsible for Drafting:** John Pearson, Olympia, 753-2336; **Implementation and Enforcement:** Ralph Munro, Olympia, 753-2336.

**Name of Proponent:** Office of the Secretary of State, public.

Rule is not necessitated by federal law, federal or state court decision.

**Explanation of Rule, its Purpose, and Anticipated Effects:** These rules provide guidelines to election officials regarding the administrative procedures to be followed when certain, specified election documents are filed by electronic facsimile transmission. The effect will be to establish uniformity throughout the state and to minimize administrative errors.

Proposal does not change existing rules.

No small business economic impact statement is required for this proposal by chapter 19.85 RCW.

**Hearing Location:** Office of the Secretary of State, on August 26, 1992, at 10:00 a.m.

**Submit Written Comments to:** Ralph Munro, Secretary of State, P.O. Box 40229, Olympia, WA, by August 19, 1992.

**Date of Intended Adoption:** August 26, 1992.

July 22, 1992

Gary McIntosh

Director of Elections

**NEW SECTION**

**WAC 434-08-060 FILING OF ELECTRONIC FACSIMILE DOCUMENTS.** In addition to those documents specified by RCW 29.04.230, the secretary of state or the county auditor shall accept and file in his or her office electronic facsimile transmissions of the following documents:

- (1) The text of any proposed initiative, referendum, or recall measure and any accompanying documents required by law;
- (2) Any minor party or independent candidate filing material except nominating petitions;
- (3) Lists of presidential electors selected by political parties or independent candidates;
- (4) Voted ballots.

**NEW SECTION**

**WAC 434-08-070 ELECTRONIC FACSIMILE FILINGS NOT ACCEPTED.** No filing by electronic facsimile shall be accepted

where a filing fee must accompany the filing unless the person making the filing has also provided for that fee to be paid in conjunction with the electronic facsimile filing. No initiative, referendum, or recall petition signatures may be filed by electronic facsimile.

#### NEW SECTION

**WAC 434-08-080 ELECTRONIC FACSIMILE FILINGS FOLLOWED BY ORIGINAL DOCUMENT.** The filing officer shall require that, except for the following documents, any acceptance of an electronic facsimile filing be followed by the original document not later than seven calendar days after the receipt of the facsimile filing:

Requests for absentee ballots.

#### NEW SECTION

**WAC 434-08-090 REJECTION OF ELECTRONIC FACSIMILE FILINGS.** The acceptance of any facsimile filing is conditional upon the person filing the document satisfying the requirements of state law and these rules with respect to such filings. The filing officer shall reject any electronic facsimile filing that does not satisfy these requirements and is not, where required, followed by the receipt of the original document in a timely manner.

**WSR 92-15-142**  
**EMERGENCY RULES**  
**DEPARTMENT OF**  
**SOCIAL AND HEALTH SERVICES**  
**(Public Assistance)**

[Filed July 22, 1992, 9:53 a.m.]

Date of Adoption: July 22, 1992.

Purpose: COPES is a Medicaid waiver program approved for a three-year period by the Health Care Financing Administration (HCFA). Approval of the waiver requires the department to serve no more clients in nursing facilities and in-home and community-based waiver services with COPES than would be served in nursing facilities without the waiver. Under this requirement, the department must restrict entry into the COPES program whenever the total number of unduplicated clients or the total federal funds expended for the waiver year is projected to exceed the amount approved by HCFA. Increases in the COPES caseload since March 1992 have far exceeded projections. Because of these increases, the department is at risk of exceeding the unduplicated client caseload approved by HCFA. Exceeding the number of unduplicated clients puts the department at risk of federal sanctions which may include loss of federal matching funds or further program restrictions. To cover federal funding losses, the department would be required to use state funding from other programs, such as chore services. This would be detrimental to the health, safety, and welfare to the chore services clients who, in general, have less income and resources than COPES clients. The department proposes emergency rules which will limit the number of new applicants for COPES services. Clients presently on COPES will continue to receive services without restrictions. The proposed rules provide for access to the program for persons residing in hospitals or nursing facilities or who are eligible for department contracted assisted living services.

Statutory Authority for Adoption: RCW 74.09.500.

Pursuant to RCW 34.05.350 the agency for good cause finds that state or federal law or federal rule or a federal deadline for state receipt of federal funds requires immediate adoption of a rule.

Reasons for this Finding: These rules are necessary to preclude the loss of federal funds.

Effective Date of Rule: Immediately.

July 22, 1992

Leslie F. James, Director  
Administrative Services

#### NEW SECTION

**WAC 388-15-615 COPES—PROGRAM RESTRICTIONS.** Effective July 20, 1992, the COPES program shall be limited to persons eligible for COPES services under WAC 388-15-610 and who:

- (1) Were in the COPES program on July 20, 1992; or
- (2) Had submitted a written application for COPES services with a Community Services Office or Aging and Adult Field Services Office as of July 20, 1992; or
- (3) Had received COPES services on or after April 1, 1992; or
- (4) For each of the thirty days preceding the date of written application for COPES services, have been either in a nursing facility as a resident or in a hospital as an inpatient; or
- (5) Are entering a department-contracted and an approved assisted living facility.

**WSR 92-15-143**  
**PROPOSED RULES**  
**DEPARTMENT OF**  
**SOCIAL AND HEALTH SERVICES**  
**(Public Assistance)**

[Filed July 22, 1992, 9:56 a.m.]

Original Notice.

Title of Rule: WAC 388-24-044 Mandatory monthly reporting.

Purpose: Implementing changes required by state plan amendment, the AFDC mandatory monthly reporting requirements are hereby modified to require the same cases for AFDC to report monthly as required by the food stamp program. This is the result of an approved federal waiver to enhance compatibility between the AFDC program and the food stamp program.

Statutory Authority for Adoption: RCW 74.04.057.

Statute Being Implemented: RCW 74.04.057.

Summary: Revise AFDC monthly reporting requirements to require the same cases for AFDC to report monthly as required for the food stamp program.

Reasons Supporting Proposal: To incorporate changes required by state plan amendment.

Name of Agency Personnel Responsible for Drafting, Implementation and Enforcement: Steve Ebben, Division of Income Assistance, 438-8311.

Name of Proponent: Department of Social and Health Services, governmental.

Rule is not necessitated by federal law, federal or state court decision.



Explanation of Rule, its Purpose, and Anticipated Effects: Same as above.

Proposal Changes the Following Existing Rules: See above.

No small business economic impact statement is required for this proposal by chapter 19.85 RCW.

Hearing Location: OB-2 Auditorium, 12th and Franklin, Olympia, Washington, on August 25, 1992, at 10:00 a.m.

Submit Written Comments to: Troyce Warner, Chief, Office of Issuances, Mailstop 5805, Department of Social and Health Services, Olympia, 98504, TELEFAX 664-0118 or SCAN 366-0118, by August 25, 1992.

Date of Intended Adoption: August 27, 1992.

July 22, 1992

Leslie F. James, Director  
Administrative Services

#### AMENDATORY SECTION (Amending Order 2400, filed 8/1/86)

WAC 388-24-044 MANDATORY MONTHLY REPORTING. (1) As a condition of continuing eligibility for AFDC, certain ~~((recipients))~~ assistance units must return to the department a completed monthly report by the fifth day of the month following the month for which the report describes the household circumstances. ~~((Recipients))~~ Assistance units required to report monthly are those ~~((who))~~ with earned income or with a recent work history except:

- (a) ~~((Are currently employed, or~~
- ~~((b) Have recent work history))~~ Migrant assistance units;
- ~~((b) Homeless assistance units; or~~
- ~~((c) Assistance units with a recent work history in which all adult members are elderly or disabled.~~

(2) ~~((Recipients))~~ Migrant assistance units and homeless assistance units, for purposes of mandatory monthly reporting, are defined as follows:

(a) "Migrant assistance unit" means an issuance unit that works in seasonal agricultural employment which requires the assistance unit to be absent from its permanent place of residence overnight;

(b) "Homeless assistance unit" means an assistance unit lacking a fixed and regular nighttime residence of whose primary nighttime residence is a:

- (i) Supervised shelter designed to provide temporary accommodations;
- (ii) Halfway house or similar institution providing temporary residence for persons needing institutionalization;
- (iii) Temporary accommodation in the residence of another person;

or

(iv) Place not designed for, or ordinarily used as, a regular sleeping accommodation for humans.

(3) Elderly and disabled, for purposes of mandatory monthly reporting, are defined as follows:

- (a) "Elderly" means a person sixty years of age or older;
- (b) "Disabled" means a person who meets one of the following criteria:

(i) Receives disability or blindness payments under Titles I, II, XIV, or XVI of the Social Security Act;

(ii) Is a veteran:

- (A) With service-connected or non-service-connected disability rated or paid as total under Title 38 of the United States Code (USC); or
- (B) Considered in need of regular aid and attendance, or permanently housebound under Title 38 of the USC.

(iii) Is a surviving spouse of a veteran and considered in need of aid and attendance, or permanently housebound; or a surviving child of a veteran and considered permanently incapable of self-support under Title 38 of the USC;

(iv) A surviving spouse or child of a veteran and entitled to compensation for service-connected death or pension benefits for a non-service-connected death under Title 38 of the USC and has a disability considered permanent under section 221(i) of the Social Security Act;

(v) Receives disability retirement benefits from a federal, state, or local government agency, because of a disability considered permanent under section 221(i) of the Social Security Act;

(vi) Receives an annuity payment as part of the Railroad Retirement Act of 1974 under:

(A) Section 2 (a)(1)(iv) and is determined eligible to receive Medicare by the Railroad Retirement Board; or

(B) Section 2 (a)(1)(v) and is determined disabled based on the criteria under Title XVI of the Social Security Act.

(vii) Is a recipient of disability-related medical assistance under Title XIX of the Social Security Act.

(4) Assistance units, for purposes of mandatory monthly reporting, include ~~((recipients))~~ assistance units having earned income ~~((deemed))~~ allocated to them from individuals living with them who have earned income or recent work history.

~~((3))~~ (5) Recent work history is defined as having received earnings in one of the two months prior to the payment month.

~~((4))~~ ~~((Recipients))~~ (6) Assistance units with recent work history are required to report for three months, including the last month of earnings.

~~((5))~~ (7) Newly approved ~~((applicants))~~ assistance units with recent work history shall be required to report for two months beginning the month following the month of opening.

~~((6))~~ (8) The first report month for ~~((newly-employed-recipients))~~ assistance units reporting new employment shall be the month following the month the department becomes aware of the earnings.

~~((7))~~ (9) Failure to return a completed report by the fifth day of the month shall result in termination except as provided in subsection ~~((9))~~ (11) of this section.

~~((8))~~ (10) The department shall give advance and adequate notice to the ~~((recipient-who))~~ assistance unit which does not submit a completed monthly report timely as defined in subsection ~~((7))~~ (9) of this section.

~~((9))~~ (11) If the ~~((recipient))~~ assistance unit furnishes the completed report to the department within ten days from the date of a termination notice pursuant to subsections (1) and ~~((7))~~ (9) of this section, the department shall:

- (a) Accept the replacement form; and
- (b) Reinstatement assistance if the information on the replacement form indicates the ~~((recipient))~~ assistance unit is still eligible.

~~((10))~~ (12) If the information on the replacement form indicates the ~~((recipient))~~ assistance unit is ineligible or eligible for an amount less than the prior month's payment, the department shall give adequate notice to the ~~((recipient))~~ assistance unit.

~~((11))~~ (13) Requirements in subsections ~~((2)), (3), (4), (5))~~ (4), (5), (6), (7), and ~~((6))~~ (8) of this section are effective with monthly reports generated in November 1985.

#### WSR 92-15-144

#### PROPOSED RULES

#### DEPARTMENT OF

#### SOCIAL AND HEALTH SERVICES

#### (Public Assistance)

[Filed July 22, 1992, 9:59 a.m.]

#### Original Notice.

Title of Rule: Chapter 388-76 WAC, Adult family homes minimum licensing requirements.

Purpose: To add newly enacted legislation regarding unlicensed adult family homes; to add language to more clearly regulate multiple facility; to clarify meaning in some sections of regulations; and to add new sections regarding common use areas and advanced directives.

Statutory Authority for Adoption: Chapter 70.128 RCW.

Statute Being Implemented: Chapter 70.128 RCW.

Summary: Add requirements for resident managers of adult family homes that are operated by a nonresident or multiple facility operator. Add further clarifying language. Add new language as a result of new law on enforcement, RCW 70.128.055 and 70.128.057.

Reasons Supporting Proposal: Add new legislation. Add new language to regulate multiple facility adult family homes. Need to clarify some sections of the licensing regulations.

Name of Agency Personnel Responsible for Drafting, Implementation and Enforcement: Lew Maudsley, Aging and Adult Services, 493-2546.

Name of Proponent: Department of Social and Health Services, governmental.

Rule is not necessitated by federal law, federal or state court decision.

Explanation of Rule, its Purpose, and Anticipated Effects: Same as above.

Proposal Changes the Following Existing Rules: See above.

No small business economic impact statement is required for this proposal by chapter 19.85 RCW.

Hearing Location: OB-2 Auditorium, 12th and Franklin, Olympia, Washington, on September 22, 1992, at 10:00 a.m.

Submit Written Comments to: Troyce Warner, Chief, Office of Issuances, Mailstop 5805, Department of Social and Health Services, Olympia, 98504, TELEFAX 664-0118 or SCAN 366-0118, by September 22, 1992.

Date of Intended Adoption: September 24, 1992.

July 22, 1992

Leslie F. James, Director  
Administrative Services

**Reviser's note:** The material contained in this filing will appear in the 92-17 issue of the Register as it was received after the applicable closing date for the issue for agency-typed material exceeding the volume limitations of WAC 1-21-040.

**WSR 92-15-145**  
**EMERGENCY RULES**  
**DEPARTMENT OF**  
**SOCIAL AND HEALTH SERVICES**  
**(Public Assistance)**

[Filed July 22, 1992, 10:04 a.m., effective July 23, 1992, 12:01 a.m.]

Date of Adoption: July 21, 1992.

Purpose: Implementing changes required by state plan amendment, the AFDC mandatory monthly reporting requirements are hereby modified to require the same cases for AFDC to report monthly as required by the food stamp program. This is the result of an approved federal waiver to enhance compatibility between the AFDC program and the food stamp program.

Citation of Existing Rules Affected by this Order: Amending WAC 388-24-044 Mandatory monthly reporting.

Statutory Authority for Adoption: RCW 74.04.057.

Pursuant to RCW 34.05.350 the agency for good cause finds that immediate adoption, amendment, or repeal of a rule is necessary for the preservation of the public health, safety, or general welfare, and that observing the time requirements of notice and opportunity to comment upon adoption of a permanent rule would be contrary to the public interest.

Reasons for this Finding: To incorporate changes required by state plan amendment.

Effective Date of Rule: 12:01 a.m., July 23, 1992.

July 22, 1992

Leslie F. James, Director  
Administrative Services

**AMENDATORY SECTION** (Amending Order 2400, filed 8/1/86)

**WAC 388-24-044 MANDATORY MONTHLY REPORTING.** (1) As a condition of continuing eligibility for AFDC, certain ((recipients)) assistance units must return to the department a completed monthly report by the fifth day of the month following the month for which the report describes the household circumstances. ((Recipients)) Assistance units required to report monthly are those ((who)) with earned income or with a recent work history except:

(a) ((Are currently employed, or

(b) Have recent work history)) Migrant assistance units;

(b) Homeless assistance units; or

(c) Assistance units with a recent work history in which all adult members are elderly or disabled.

(2) ((Recipients)) Migrant assistance units and homeless assistance units, for purposes of mandatory monthly reporting, are defined as follows:

(a) "Migrant assistance unit" means an issuance unit that works in seasonal agricultural employment which requires the assistance unit to be absent from its permanent place of residence overnight;

(b) "Homeless assistance unit" means an assistance unit lacking a fixed and regular nighttime residence of whose primary nighttime residence is a:

(i) Supervised shelter designed to provide temporary accommodations;

(ii) Halfway house or similar institution providing temporary residence for persons needing institutionalization;

(iii) Temporary accommodation in the residence of another person; or

(iv) Place not designed for, or ordinarily used as, a regular sleeping accommodation for humans.

(3) Elderly and disabled, for purposes of mandatory monthly reporting, are defined as follows:

(a) "Elderly" means a person sixty years of age or older;

(b) "Disabled" means a person who meets one of the following criteria:

(i) Receives disability or blindness payments under Titles I, II, XIV, or XVI of the Social Security Act;

(ii) Is a veteran;

(A) With service-connected or nonservice-connected disability rated or paid as total under Title 38 of the United State Code (USC); or

(B) Considered in need of regular aid and attendance, or permanently housebound under Title 38 of the USC.

(iii) Is a surviving spouse of a veteran and considered in need of aid and attendance, or permanently housebound; or a surviving child of a veteran and considered permanently incapable of self-support under Title 38 of the USC;

(iv) A surviving spouse or child of a veteran and entitled to compensation for service-connected death or

pension benefits for a nonservice-connected death under Title 38 of the USC and has a disability considered permanent under section 221(i) of the Social Security Act;

(v) Receives disability retirement benefits from a federal, state, or local government agency, because of a disability considered permanent under section 221(i) of the Social Security Act;

(vi) Receives an annuity payment as part of the Railroad Retirement Act of 1974 under:

(A) Section 2 (a)(1)(iv) and is determined eligible to receive Medicare by the Railroad Retirement Board; or

(B) Section 2 (a)(1)(v) and is determined disabled based on the criteria under Title XVI of the Social Security Act.

(vii) Is a recipient of disability-related medical assistance under Title XIX of the Social Security Act.

(4) Assistance units, for purposes of mandatory monthly reporting, include ((recipients)) assistance units having earned income ((deemed)) allocated to them from individuals living with them who have earned income or recent work history.

((3)) (5) Recent work history is defined as having received earnings in one of the two months prior to the payment month.

((4) Recipients) (6) Assistance units with recent work history are required to report for three months, including the last month of earnings.

((5)) (7) Newly approved ((applicants)) assistance units with recent work history shall be required to report for two months beginning the month following the month of opening.

((6)) (8) The first report month for ((newly employed recipients)) assistance units reporting new employment shall be the month following the month the department becomes aware of the earnings.

((7)) (9) Failure to return a completed report by the fifth day of the month shall result in termination except as provided in subsection ((9)) (11) of this section.

((8)) (10) The department shall give advance and adequate notice to the ((recipient who)) assistance unit which does not submit a completed monthly report timely as defined in subsection ((7)) (9) of this section.

((9)) (11) If the ((recipient)) assistance unit furnishes the completed report to the department within ten days from the date of a termination notice pursuant to subsections (1) and ((7)) (9) of this section, the department shall:

(a) Accept the replacement form; and

(b) Reinstate assistance if the information on the replacement form indicates the ((recipient)) assistance unit is still eligible.

((10)) (12) If the information on the replacement form indicates the ((recipient)) assistance unit is ineligible or eligible for an amount less than the prior month's payment, the department shall give adequate notice to the ((recipient)) assistance unit.

((11)) (13) Requirements in subsections ((2), (3), (4), (5)) (4), (5), (6), (7), and ((6)) (8) of this section are effective with monthly reports generated in November 1985.

**WSR 92-15-146**  
**PROPOSED RULES**  
**SUPERINTENDENT OF**  
**PUBLIC INSTRUCTION**  
 [Filed July 22, 1992, 10:33 a.m.]

Original Notice.

Title of Rule: Chapter 392-141 WAC, Transportation—State allocations for operations.

Purpose: To amend chapter 392-141 WAC to fund the transportation of homeless students with the special transportation formula, and to allow for the reimbursement of low-income students enrolled in schools pursuant to the choice program.

Statutory Authority for Adoption: RCW 28A.150.290.

Statute Being Implemented: RCW 28A.160.150- [28A.160.]170 and section 506, chapter 16, Laws of 1991, 1st ex. sess.

Summary: These amendments allow transportation of homeless students to be funded in the special transportation funding formula, and will allow reimbursement to low-income parents of students enrolled in the choice program who are not otherwise transported to and from school.

Reasons Supporting Proposal: Currently the transportation of the homeless is inadequately funded, and low-income choice families are not reimbursed when transportation is not provided.

Name of Agency Personnel Responsible for Drafting: Rick M. Wilson, Superintendent of Public Instruction, Old Capitol Building, (206) 753-2298; Implementation: David L. Moberly, Superintendent of Public Instruction, Old Capitol Building, (206) 753-6742; and Enforcement: Don M. Carnahan, Superintendent of Public Instruction, Old Capitol Building, (206) 753-0235.

Name of Proponent: Superintendent of Public Instruction, governmental.

Rule is not necessitated by federal law, federal or state court decision.

Explanation of Rule, its Purpose, and Anticipated Effects: See Purpose above.

Proposal Changes the Following Existing Rules: Allows the reporting of the transportation of homeless students in the special transportation category, and adds new sections for reimbursement to low-income families of choice students.

No small business economic impact statement is required for this proposal by chapter 19.85 RCW.

Hearing Location: Superintendent of Public Instruction, Old Capitol Building, Wanamaker Conference Room, 2nd Floor, Olympia, Washington 98504-7200, on August 28, 1992, at 9:00 a.m.

Submit Written Comments to: Richard M. Wilson, P.O. Box 47200, Olympia, WA 98504-7200, by August 25, 1992.

Date of Intended Adoption: September 4, 1992.

July 22, 1992  
 Judith A. Billings  
 Superintendent of  
 Public Instruction

AMENDATORY SECTION (Amending Order 92-03, filed 3/23/92, effective 4/23/92)

WAC 392-141-148 **DEFINITION—SPECIAL TRANSPORTATION.** As used in this chapter, "special transportation" means students transported from home to school for their gifted ((σ)), bilingual, or homeless programs, or for special education programs pursuant to chapter 28A.155 RCW and chapter 392-141 WAC.

NEW SECTION

WAC 392-141-159 **DEFINITION—CHOICE PROGRAM TRANSPORTATION.** As used in this chapter, "choice program transportation" means, pursuant to RCW 28A.225.220 through 28A.225.320, 28A.230.090(8), 28A.175.090, and State Operating Appropriations Act, funding is provided for reimbursement of transportation costs for students participating in choice who are from low-income families and who are not otherwise transported by a school district.

NEW SECTION

WAC 392-141-205 **CHOICE LOW-INCOME CRITERIA.** For the purpose of reimbursement of transportation costs regarding choice, low-income criteria shall be the same as that referenced in WAC 392-100-100 through 392-100-102. Gross income used to determine eligibility shall be for the most recent twelve months.

NEW SECTION

WAC 392-141-210 **CHOICE PROGRAM TRANSPORTATION ELIGIBILITY FOR REIMBURSEMENT.** Parent(s), custodial parent(s), guardian(s), or person(s) in loco parentis who transport students participating in choice and meet the low-income family criteria pursuant to WAC 392-100-100, may be entitled to reimbursement for the transportation of those students.

NEW SECTION

WAC 392-141-215 **CHOICE CALCULATION OF PAYMENT.** Reimbursement shall be computed by multiplying the actual total daily miles to and from school by the rate of reimbursement per mile that is now or hereafter authorized by law for state employees for the use of private motor vehicles in connection with state business.

NEW SECTION

WAC 392-141-220 **CHOICE REIMBURSEMENT LIMITATIONS.** The calculation of reimbursement payments for mileage shall be made on a per vehicle basis, regardless of the number of occupants, and shall be limited to the most direct route to and from the destination school or bus stop, and to one hundred eighty days per school year. Mileage shall be the actual and reported miles driven, not to exceed more than two round trips per day and shall be limited to one vehicle per family per destination school or school bus stop.

NEW SECTION

WAC 392-141-225 **CHOICE METHOD OF PAYMENT.** The following process shall be followed when applying for transportation reimbursement for choice:

(1) The applicant shall submit documentation and a reimbursement request to the school district at least annually which provides information that the school district can use to determine if the applicant meets low-income criteria and an application which includes, but is not limited to:

- (a) The name(s) of students participating and transported;
- (b) The actual total daily miles of the transporting vehicle;
- (c) The name(s) of the school(s) of attendance;
- (d) The number of days transported; and
- (e) The signature of the applicant.

(2) The school district where the choice student is participating shall:

- (a) Furnish eligible applicants with a school district application form which includes the items in subsection (1) of this section;
- (b) Determine if the applicant's application meets the low-income criteria pursuant to WAC 392-100-101;
- (c) Observe student confidentiality pursuant to WAC 392-100-102;
- (d) Provide the applicant with a school district reimbursement claim form; and

(e) Review and process the claim for reimbursement and provide reimbursement payments.

(3) For state reimbursement purposes, the school district shall submit an invoice and the above stated support documentation to the regional transportation coordinator for review.

(4) The regional transportation coordinator shall:

(a) Review the invoice and documentation submitted by the school district for accuracy and completeness; and

(b) Upon approval, submit the invoice to the superintendent of public instruction for payment.

(5) The superintendent of public instruction shall:

(a) Review the invoice submitted for choice transportation;

(b) Provide reimbursement to the school district as claims are received;

(c) Reimburse for choice transportation through the next monthly apportionment payment; and

(d) Identify reimbursement separate from all other school district transportation program allocations or funds.

(6) The school district shall furnish the superintendent of public instruction an annual report by September 30th of each school year detailing schools of attendance, total vehicles, total miles claimed, total days claimed, and the total amount of the reimbursement for choice transportation.

NEW SECTION

WAC 392-141-230 **CHOICE APPROPRIATION LIMITATION.** Reimbursement to school districts shall be in accordance with the foregoing procedures until the legislative appropriation for this program is reached. School districts have the option of terminating their participation in choice transportation when the appropriation limit is reached or may choose to continue the program using local funds.

**WSR 92-15-147  
PROPOSED RULES  
DEPARTMENT OF  
LABOR AND INDUSTRIES**

[Order 92-06—Filed July 22, 1992, 10:53 a.m.]

Original Notice.

Title of Rule: Chapter 296-24 WAC, General safety and health standards; chapter 296-37 WAC, Standards for commercial diving operations; chapter 296-56 WAC, Safety standards—Longshore, stevedore and related waterfront operations; chapter 296-62 WAC, General occupational health standards; and chapter 296-155 WAC, Safety standards for construction work.

Purpose: Chapter 296-24 WAC, General safety and health standards, federal-initiated amendments to WAC 296-24-11001 through 296-24-119 are to make the existing state standards at-least-as-effective-as the comparable federal final rules by incorporating OSHA recommendations dated January 8, 1992. These recommendations are in response to state plan change supplements submitted on June 17, 1991, for lockout/tagout; chapter 296-37 WAC, Standards for commercial diving operations, federal-initiated proposed amendments to WAC 296-37-510 through 296-37-590 are to incorporate recommended OSHA comments into the standard to make the WISHA standard at-least-as-effective-as the federal final rule. Prior changes to the standard were submitted for federal approval and returned with recommendations on June 6, 1991. Changes being incorporated consist of additions, deletions, and changes to the narrative to make the standard more "near identical" to

the federal rule. The changes do not establish any significant new compliance requirements; chapter 296-56 WAC, Safety standards—Longshore, stevedore and related waterfront operations, federal-initiated proposed amendments to 26 sections of this chapter are to incorporate recommended OSHA comments into the standards to make them at-least-as-effective-as the comparable federal rule. Prior changes to the standard were submitted for federal approval and returned with recommendations on January 17, 1991. Changes being incorporated consisted of additions, deletions and changes to narrative to make the standard more "near-identical" to the federal rule. The changes do not establish any significant new compliance requirements; chapter 296-62 WAC, General occupational health standards, state-initiated amendment to WAC 296-62-09005, relating to nonionizing radiation, is a housekeeping change to correct a typographical error within the text; and chapter 296-155 WAC, Safety standards for construction work, federal-initiated amendment to WAC 296-155-48536 is to make existing state standards at-least-as-effective-as the comparable federal final rules by incorporating OSHA recommendations dated June 17, 1991. These recommendations are in response to changes adopted by administrative order of adoption number 89-03 on May 15, 1989. Federal-initiated proposed amendments to WAC 296-155-650 through 296-155-66411 are to incorporate recommended OSHA comments into the standard to make the WISHA standard at-least-as-effective-as the comparable federal rule. Prior changes to the standard were submitted for federal approval and were returned with recommendations on November 8, 1991. Changes being incorporated consist of additions, deletions and changes to narrative to make the standard more "near identical" to the federal rule. The changes do not establish any significant new compliance requirements. Federal-initiated housekeeping amendment to WAC 296-155-694 is to add an illustration that was omitted from the section. This amendment is made to be identical to the federal final rule.

Statutory Authority for Adoption: Chapter 49.17 RCW.

Statute Being Implemented: RCW 49.17.040, 49.17.050, and 49.17.060.

Summary: See Purpose above.

Reasons Supporting Proposal: To ensure a safe and healthful workplace for all employees in Washington state.

Name of Agency Personnel Responsible for Drafting: Ray V. Wax, 805 Plum Street, Olympia, WA, 753-6381; Implementation and Enforcement: J. N. Kirchoff, 805 Plum Street, Olympia, WA, 753-6500.

Name of Proponent: Department of Labor and Industries, governmental.

Rule is necessary because of federal law, 29 CFR 1910.147, 1910.178 and 1910 Subpart T; 29 CFR 1926 Subpart P; 29 CFR 1917.

Explanation of Rule, its Purpose, and Anticipated Effects: See Purpose above and Small Business Economic Impact Statement below.

Proposal Changes the Following Existing Rules: See Purpose above and Small Business Economic Impact Statement below.

No small business economic impact statement is required for this proposal by chapter 19.85 RCW.

The department has considered whether these rule changes are subject to the Regulatory Fairness Act and has determined that they are not for the following reasons: Chapter 296-24 WAC, General safety and health standards, federal-initiated amendments to WAC 296-24-11001 through 296-24-119 are made solely to conform to federal OSHA recommendations dated January 8, 1992; chapter 296-37 WAC, Standards for commercial diving operations, federal-initiated proposed amendments to WAC 296-37-510 through 296-37-590 are made solely to conform to federal OSHA recommendations dated June 6, 1991; chapter 296-56 WAC, Safety standards—Longshore, stevedore and related waterfront operations, federal-initiated proposed amendments to 26 sections of this chapter area made solely to conform or comply with federal laws and regulations; chapter 296-62 WAC, General occupational health standards, federal-initiated proposed amendment to WAC 296-62-09905 is to correct a typographical error. There are no new compliance requirements as a result of this proposed housekeeping change; and chapter 296-155 WAC, Safety standards for construction work, federal-initiated amendment to WAC 296-155-48536 is made solely to conform to federal OSHA recommendations dated June 17, 1991. Federal-initiated proposed amendments to WAC 296-155-650 through 296-155-66411 are made solely to conform to federal OSHA recommendations dated November 8, 1991. Federal-initiated proposed housekeeping amendment to WAC 296-155-694 is made solely to conform to federal regulations.

Hearing Location: General Administration Building Auditorium, Olympia, Washington 98504, on August 27, 1992, at 9:30 a.m.

Submit Written Comments to: J. N. Kirchoff, Assistant Director, Division of Industrial Safety and Health, by August 27, 1992, 5:00 p.m.

Date of Intended Adoption: October 9, 1992.

July 22, 1992

Joseph A. Dear  
Director

AMENDATORY SECTION (Amending Order 91-01, filed 5/20/91, effective 6/20/91)

WAC 296-24-11001 SCOPE, APPLICATION, AND PURPOSE. (1) Scope.

(a) This standard covers the ((~~operation~~)) servicing and maintenance of ((~~all~~)) machines((;)) and equipment ((~~and systems~~)) in which the unexpected energization or start up((;)) of the machine or equipment or release of stored energy could cause injury to employees. This standard establishes minimum performance requirements for the control of such hazardous energy.

(b) This standard does not cover the following:

- (i) Construction, agriculture, and maritime employment;
  - (ii) Installations under the exclusive control of electric utilities for the purpose of power generation, transmission, and distribution, including related equipment for communications or metering; and
  - (iii) Exposure to electrical hazards from work on, near, or with conductors or equipment in electric utilization installations, which is covered by Part L of chapter 296-24 WAC; and
  - (iv) Oil and gas well drilling and servicing.
- (2) Application.

(a) This standard applies to the control of energy during servicing and/or maintenance of machines and equipment ~~((and systems))~~.

(b) Normal production operations are not covered by this standard ~~((where no personnel exposure exists))~~ (see Part C of chapter 296-24 WAC). Servicing and/or maintenance which takes place during normal production operations is covered by this standard ~~((when))~~ only if:

(i) An employee is required to remove or bypass a guard or other safety device; or

(ii) An employee is required to place any part of his or her body into an area on a machine or piece of equipment where work is actually performed upon the material being processed (point of operation) or where an associated danger zone exists during a machine operating cycle.

**Note:** Exception~~(s)~~ to subdivision (b) of this subsection. Minor tool changes and adjustments, and other minor servicing activities, which take place during normal production operations, are not covered by this standard if they are routine, repetitive, and integral to the use of the equipment for production, provided that the work is performed using alternative measures which provide effective protection ~~((and/or personnel exposure does not exist. See Appendix B for running adjustment procedures))~~ (see Part C of chapter 296-24 WAC).

(c) This standard does not apply to the following:

(i) ~~((When the Title 296 WAC vertical standard for an industry requires a lockout or tagout control program, the vertical standard shall be used for all requirements directly addressed by that standard. The horizontal requirements of this chapter shall supplement the vertical standards, including the details of issues such as the procedural and training requirements of this chapter.~~

~~((iii))~~ Work on cord and plug connected electric equipment ~~((when))~~ for which exposure to the hazards of unexpected energization or start up of the equipment is controlled by the unplugging of the equipment from the energy source and by the plug being under the exclusive control of the employee performing the servicing or maintenance.

~~((iii))~~ (ii) Hot tap operations involving transmission and distribution systems for substances such as gas, steam, water, or petroleum products when they are performed on pressurized pipelines, provided that the employer demonstrates that:

(A) Continuity of service is essential; ~~((and))~~

(B) Shutdown of the system is impractical; and

(C) Documented procedures are followed, and special equipment is used which will provide proven effective protection for employees~~(; and~~

~~((D))~~ The employees involved are specifically trained and qualified on the equipment and procedures to be used.

~~((iv))~~ Construction, agriculture, and maritime employment.

~~((v))~~ Installations under the exclusive control of electric utilities for the purpose of power generation, transmission, and distribution, including related equipment for communications or metering.

~~Exposure to electrical hazards from work on, near, or with conductors or equipment in electric utilization installations, which is covered by WAC 296-24-956 through 296-24-960.~~

~~((vi))~~ Oil and gas well drilling and servicing).

(3) Purpose.

~~(a)~~ This section requires employers to establish a written ~~((lockout/tagout))~~ program~~((; train affected employees and ensure that adequate))~~ and utilize procedures ~~((are used))~~ for affixing appropriate lockout devices or tagout devices to energy isolating devices, and to otherwise disable machines~~(;)~~ or equipment ~~((or systems))~~ to prevent unexpected energization, start-up, or release of stored energy in order to prevent injury to employees.

~~(b)~~ When other Title 296 WAC vertical standards require the use of lockout or tagout, they shall be used and supplemented by the procedural and training requirements of this Part.

**AMENDATORY SECTION** (Amending Order 91-01, filed 5/20/91, effective 6/20/91)

WAC 296-24-11003 DEFINITIONS APPLICABLE TO THIS SECTION. (1) Affected employee. ~~((Any person))~~ An employee whose job requires him/her to operate or use a machine or equipment on which servicing or maintenance is being performed under lockout or tagout, or whose job requires him/her to ~~((be))~~ work in an area ~~((potentially influenced by the))~~ in which such servicing or maintenance is being performed.

(2) Authorized~~((designated individual shall mean an individual who is qualified by reason of training and to whom the authority and responsibility to perform a specific assignment has been given by the owner/management. With respect to the requirements of this Part A-~~

~~4, such authority and responsibility shall include deactivating and locking or tagging out equipment and/or systems in compliance with the requirements of this chapter and the employer control program when servicing or maintenance activities could create exposure for the authorized person or other affected employee(s))~~ employee. A person who locks out or tags out machines or equipment in order to perform servicing or maintenance on that machine or equipment. An affected employee becomes an authorized employee when that employee's duties include performing servicing or maintenance covered under this section.

(3) ~~((Authorized employer representative shall mean an individual who is specifically qualified by reason of training and to whom owner/management has designated authority and responsibility for a specific assignment:~~

~~((4))~~ Capable of being locked out. An energy isolating device is capable of being locked out if it has a hasp or other means of attachment to which, or through which, a lock can be affixed, or it has a locking mechanism built into it. Other energy isolating devices are capable of being locked out, if lockout can be achieved without the need to dismantle, rebuild, or replace the energy isolating device or permanently alter its energy control capability.

~~((5))~~ (4) Energized. Connected to an energy source or containing residual or stored energy.

~~((6))~~ (5) Energy isolating device. A mechanical device that physically prevents the transmission or release of energy, including but not limited to the following: A manually operated electrical circuit breaker; a disconnect switch; a manually operated switch by which the conductors of a circuit can be disconnected from all ungrounded supply conductors and, in addition, no pole can be operated independently; ~~((a slide gate, a slip blind;))~~ a line valve; a block; and any similar device used to block or isolate energy. ~~((The term does not include a))~~ Push buttons, selector ~~((switch, remote control switches, automatic circuit activating devices, and other control circuit type))~~ switches, and other control circuit type devices are not energy isolating devices.

~~((7))~~ (6) Energy source. Any source of electrical, mechanical, hydraulic, pneumatic, chemical, thermal or other energy, including gravity.

~~((8))~~ (7) Hot tap. A procedure used in the repair, maintenance, and services activities which involves welding on a piece of equipment (pipelines, vessels, or tanks) under pressure, in order to install connections or appurtenances. It is commonly used to replace or add sections of pipeline without the interruption of service for air, gas, water, steam, and petrochemical distribution systems.

~~((9))~~ (8) Lockout. The placement of a lockout device on an energy isolating device, in accordance with an established procedure, ensuring that the energy isolating device and the equipment being controlled cannot be operated until the lockout device is removed.

~~((10))~~ (9) Lockout device. A device that utilizes a positive means such as a lock, either key or combination type, to hold an energy isolating device in the safe position and prevents the energizing of a machine or equipment. Included are blank flanges and bolted slid blinds.

~~((11))~~ (10) Normal production operations. The utilization of a machine or equipment to perform its intended production function.

~~((12))~~ (11) Servicing and/or maintenance. Workplace activities such as constructing, installing, setting up, adjusting, inspecting, modifying, and maintaining and/or servicing machines or equipment. These activities include lubrication, cleaning, or unjamming of machines or equipment and making adjustments or tool changes, where the employee may be exposed to the unexpected energization or startup of the equipment or release of hazardous energy.

~~((13))~~ (12) Setting up. Any work performed to prepare a machine or equipment to perform its normal production operation.

~~((14))~~ (13) Tagout. The placement of a tagout device on an energy isolating device, in accordance with an established procedure, to indicate that the energy isolating device and the equipment being controlled may not be operated until the tagout device is removed.

~~((15))~~ (14) Tagout device. A prominent warning device, such as a tag and a means of attachment, which can be securely fastened to an energy isolating device in accordance with an established procedure, to indicate that the energy isolating device and the equipment being controlled may not be operated until the tagout device is removed ~~((in accordance with approved company procedures))~~.

**AMENDATORY SECTION** (Amending Order 91-01, filed 5/20/91, effective 6/20/91)

WAC 296-24-11005 GENERAL ((REQUIREMENTS)). ((Energy control program:))

(1) Energy control program. The employer shall establish a written program consisting of an energy control procedure, employee training and periodic inspections to ensure that before any employee performs any servicing or maintenance on a machine or equipment where the unexpected energizing, start up, or release of stored energy could occur and cause injury, the machine((:)) or equipment((: system, or process)) shall be isolated from the energy source, and rendered inoperative((: in accordance with this Part A-4)).

(2) Lockout/tagout.

(a) If an energy isolating device is not capable of being locked out, the employer's energy control program under subsection (1) of this section shall utilize a tagout system.

(b) If an energy isolating device is capable of being locked out, the employer's energy control program under subsection (1) of this section shall utilize lockout unless the employer can demonstrate that the utilization of a tagout system will provide full employee protection as set forth in subsection (3) of this section.

(c) After the effective date of this section, whenever major replacement((:)) or major repair, renovation, ((relocation;)) or modification of a machine((s)) or equipment is performed, and whenever new machines or equipment are installed, energy isolating devices for such machines or equipment shall be designed to accept a lockout device.

(3) Full employee protection.

(a) When a tagout device is used on an energy isolating device which is capable of being locked out, the tagout device shall be attached at the same location that the lockout device would have been attached, and the employer shall demonstrate that the tagout program will provide a level of safety equivalent to that obtained by using a lockout program.

(b) In demonstrating that a level of safety is achieved in the tagout program which is equivalent to the level of safety obtained by using a lockout program, the employer shall demonstrate full compliance with all tagout-related provisions of this standard together with such additional elements as are necessary to provide the equivalent safety available from the use of a lockout device. Additional means to be considered as part of the demonstration of full employee protection shall include the implementation of additional safety measures such as the removal of an isolating circuit element, blocking of a controlling switch, opening of an extra disconnecting device, or the removal of a valve handle to reduce the likelihood of inadvertent energization.

(4) Energy control procedure.

(a) Procedures shall be developed, documented, and utilized for the control of potentially hazardous energy when employees are engaged in the activities covered by this section.

Note: Exception: The employer need not document the required procedure for a particular machine or equipment when all of the following elements exist:

(i) The machine or equipment has no potential for stored or residual energy or reaccumulation of stored energy after shut down which could endanger employees;

(ii) The machine or equipment has a single energy source which can be readily identified and isolated;

(iii) The isolation and locking out of that energy source will completely deenergize and deactivate the machine or equipment;

(iv) The machine or equipment is isolated from that energy source and locked out during servicing or maintenance;

(v) A single lockout device will achieve a locked-out condition;

(vi) The lockout device is under the exclusive control of the authorized employee performing the servicing or maintenance;

(vii) The servicing or maintenance does not create hazards for other employees; and

(viii) The employer, in utilizing this exception, has had no accidents involving the unexpected activation or reenergization of the machine or equipment during servicing or maintenance.

(b) The procedures shall clearly and specifically outline the scope, purpose, authorization, rules, and techniques to be utilized for the control of hazardous energy, and the means to enforce compliance including, but not limited to, the following:

(i) A specific statement of the intended use of the procedure;

(ii) Specific procedural steps for shutting down, isolating, blocking, and securing machines or equipment to control hazardous energy;

(iii) Specific procedural steps for the placement, removal, and transfer of lockout devices or tagout devices and the responsibility for them; and

(iv) Specific requirements for testing a machine or equipment to determine and verify the effectiveness of lockout devices, tagout devices, and other energy control measures.

(5) Protective materials and hardware.

(a) Locks, tags, chains, wedges, key blocks, adapter pins, self-locking fasteners, or other hardware shall be provided by the employer for isolating, securing, or blocking of machines or equipment from energy sources.

(b) Lockout devices and tagout devices shall be singularly identified; shall be the only device(s) used for controlling energy; shall not be used for other purposes; and shall meet the following requirements:

(i) Durable.

(A) Lockout devices and tagout devices shall be capable of withstanding the environment to which they are exposed for the maximum period of time that exposure is expected.

(B) Tagout devices shall be constructed and printed so that exposure to weather conditions or wet and damp locations will not cause the tag to deteriorate or the message on the tag to become illegible.

(C) Tags shall not deteriorate when used in corrosive environments such as areas where acid and alkali chemicals are handled and stored.

(ii) Standardized. Lockout and tagout devices shall be standardized within the facility in at least one of the following criteria: Color; shape; or size; and additionally, in the case of tagout devices, print and format shall be standardized.

(iii) Substantial.

(A) Lockout devices. Lockout devices shall be substantial enough to prevent removal without the use of excessive force or unusual techniques, such as with the use of bolt cutters or other metal cutting tools.

(B) Tagout devices. Tagout devices, including and their means of attachment, shall be substantial enough to prevent inadvertent or accidental removal. Tagout device attachment means shall be of a non-reusable type, attachable by hand, self-locking, and nonreleasable with a minimum unlocking strength of no less than 50 pounds and having the general design and basic characteristics of being at least equivalent to a one-piece, all-environment-tolerant nylon cable tie.

(C) Identifiable. Lockout devices and tagout devices shall indicate the identity of the employee applying the device(s).

(c) Tagout devices shall warn against hazardous conditions if the machine or equipment is energized and shall include a legend such as the following: Do not start, do not open, do not close, do not energize, do not operate.

(6) Periodic inspection.

(a) The employer shall conduct a periodic inspection of the energy control procedure at least annually to ensure that the procedure and the requirements of this standard are being followed.

(i) The periodic inspection shall be performed by an authorized employee other than the one(s) utilizing the energy control procedure being inspected.

(ii) The periodic inspection shall be conducted to correct any deviations or inadequacies identified.

(iii) Where lockout is used for energy control, the periodic inspection shall include a review, between the inspector and each authorized employee, of that employee's responsibilities under the energy control procedure being inspected.

(iv) Where tagout is used for energy control, the periodic inspection shall include a review, between the inspector and each authorized and affected employee, of that employee's responsibilities under the energy control procedure being inspected, and the elements set forth in subsection (7)(b) of this section.

(b) The employer shall certify that the periodic inspections have been performed. The certification shall identify the machine or equipment on which the energy control procedure was being utilized, the date of the inspection, the employees included in the inspection, and the person performing the inspection.

(7) Training and communication.

(a) The employer shall provide training to ensure that the purpose and function of the energy control program are understood by employees and that the knowledge and skills required for the safe application, usage, and removal of the energy controls are acquired by employees. The training shall include the following:

(i) Each authorized employee shall receive training in the recognition of applicable hazardous energy sources, the type and magnitude of the energy available in the workplace, and the methods and means necessary for energy isolation and control.

(ii) Each affected employee shall be instructed in the purpose and use of the energy control procedure.

(iii) All other employees whose work operations are or may be in an area where energy control procedures may be utilized, shall be instructed about the procedure, and about the prohibition relating to attempts to restart or reenergize machines or equipment which are locked out or tagged out.



(b) When tagout systems are used, employees shall also be trained in the following limitations of tags:

(i) Tags are essentially warning devices affixed to energy isolating devices, and do not provide the physical restraint on those devices that is provided by a lock.

(ii) When a tag is attached to an energy isolating means, it is not to be removed without authorization of the authorized person responsible for it, and it is never to be bypassed, ignored, or otherwise defeated.

(iii) Tags must be legible and understandable by all authorized employees, affected employees, and all other employees whose work operations are or may be in the area, in order to be effective.

(iv) Tags and their means of attachment must be made of materials which will withstand the environmental conditions encountered in the workplace.

(v) Tags may evoke a false sense of security, and their meaning needs to be understood as part of the overall energy control program.

(vi) Tags must be securely attached to energy isolating devices so that they cannot be inadvertently or accidentally detached during use.

(c) Employee retraining.

(i) Retraining shall be provided for all authorized and affected employees whenever there is a change in their job assignments, a change in machines, equipment or processes that present a new hazard, or when there is a change in the energy control procedures.

(ii) Additional retraining shall also be conducted whenever a periodic inspection under subsection (6) of this section reveals, or whenever the employer has reason to believe, that there are deviations from or inadequacies in the employee's knowledge or use of the energy control procedures.

(iii) The retraining shall reestablish employee proficiency and introduce new or revised control methods and procedures, as necessary.

(d) The employer shall certify that employee training has been accomplished and is being kept up to date. The certification shall contain each employee's name and dates of training.

(8) Energy isolation. Lockout or tagout shall be performed only by authorized employees who are performing the servicing or maintenance.

(9) Notification of employees. Affected employees shall be notified or authorized employee of the application and removal of lockout devices or tagout devices. Notification shall be given before the controls are applied, and after they are removed from the machine or equipment.

**AMENDATORY SECTION** (Amending Order 91-01, filed 5/20/91, effective 6/20/91)

WAC 296-24-11007 ((ENERGY CONTROL PROCEDURE)) APPLICATION OF CONTROL. (((+)) Procedures shall be developed, documented, and utilized for the control of potentially hazardous energy when employees are engaged in the activities covered by this section. Exception: The employer need not document the required procedure for a particular machine or equipment when all of the following elements exist:

(a) The machine or equipment has no potential for stored or residual energy or reaccumulation of stored energy after shut down which could endanger employees;

(b) The machine or equipment has a single energy source which can be readily identified and isolated;

(c) The isolation and locking out of that energy source will completely deenergize and deactivate the machine or equipment;

(d) The machine or equipment is isolated from that energy source and locked out during servicing or maintenance;

(e) A single lockout device will achieve a locked-out condition;

(f) The lockout device is under the exclusive control of the authorized employee performing the servicing or maintenance;

(g) The servicing or maintenance does not create hazards for other employees;

(h) The employer, in utilizing this exception, has had no accidents involving the unexpected activation or reenergization of the machine or equipment during servicing or maintenance.

(2) The procedures shall clearly and specifically outline the scope, purpose, authorization, rules, and techniques to be utilized for the control of hazardous energy, and the means to enforce compliance including, but not limited to, the following:

(a) A specific statement of the intended use of the procedure;

(b) Specific procedural steps for shutting down, isolating, blocking, and securing machines or equipment to control hazardous energy;

(c) Specific procedural steps for the placement, removal, and transfer of lockout devices or tagout devices and the responsibility for them; and

(d) Specific requirements for testing a machine or equipment to determine and verify the effectiveness of lockout devices, tagout devices, and other energy control measures:)) (1) The established procedures for the application of energy control (the lockout or tagout procedures) shall cover the following elements and actions and shall be done in the following sequence:

(a) Preparation for shutdown. Before an authorized or affected employee turns off a machine or equipment, the authorized employee shall have knowledge of the type and magnitude of the energy, the hazards of the energy to be controlled, and the method or means to control the energy.

(b) Machine or equipment shutdown. The machine or equipment shall be turned off or shut down using the procedures established for the machine or equipment. An orderly shutdown must be utilized to avoid any additional or increased hazard(s) to employees as a result of equipment stoppage.

(c) Machine or equipment isolation. All energy isolating devices that are needed to control the energy to the machine or equipment shall be physically located and operated in such a manner as to isolate the machine or equipment from the energy source(s).

(2) Lockout or tagout device application.

(a) Lockout or tagout devices shall be affixed to each energy isolating device by authorized employees.

(b) Lockout devices, where used, shall be affixed in a manner that will hold the energy isolating devices in a "safe" or "off" position.

(c) Tagout devices, where used, shall be affixed in such a manner as will clearly indicate that the operation or movement of energy isolating devices from the "safe" or "off" position is prohibited.

(i) Where tagout devices are used with energy isolating devices designed with the capability of being locked, the tag attachment shall be fastened at the same point at which the lock would have been attached.

(ii) Where a tag cannot be affixed directly to the energy isolating device, the tag shall be located as close as safely possible to the device, in a position that will be immediately obvious to anyone attempting to operate the device.

(3) Stored energy.

(a) Following the application of lockout or tagout devices to energy isolating devices, all potentially hazardous stored or residual energy shall be relieved, disconnected, restrained, and otherwise rendered safe.

(b) If there is a possibility of reaccumulation of stored energy to a hazardous level, verification of isolation shall be continued until the servicing or maintenance is completed, or until the possibility of such accumulation no longer exists.

(4) Verification of isolation. Prior to starting work on machines or equipment that have been locked out or tagged out, the authorized employee shall verify that isolation and deenergization of the machine or equipment have been accomplished.

**AMENDATORY SECTION** (Amending Order 91-01, filed 5/20/91, effective 6/20/91)

WAC 296-24-11009 ((PROTECTIVE MATERIALS AND HARDWARE)) RELEASE FROM LOCKOUT OR TAGOUT. (((+)) Locks, tags, chains, wedges, key blocks, adapter pins, self-locking fasteners, or other hardware shall be provided by the employer for isolating, securing, or blocking of machines or equipment from energy sources:

(2) Lockout devices and tagout devices shall be singularly identified; shall be the only device(s) used for controlling energy; shall not be used for other purposes; and shall meet the following requirements:

(a) Durable:

(i) Lockout devices and tagout devices, including the attachment means, shall be capable of withstanding the environment to which they are exposed for the maximum period of time that exposure is expected:

(ii) Tagout devices shall be constructed and printed so that exposure to weather conditions or wet and damp locations will not cause the message on the tag to become illegible:

(iii) Tags shall not deteriorate when used in corrosive environments such as areas where acid and alkali chemicals are handled and stored:

(b) Standardized:

(i) Lockout and tagout devices shall be standardized within the facility in at least one of the following criteria: Color, shape, or size, and additionally, in the case of tagout devices, print and format shall be standardized:



(ii) Employers should be guided by WAC 296-24-140, Specifications for accident prevention signs and tags, when designing/selecting the content and format of tagout devices.

(c) Substantial:

(i) Lockout devices. Lockout devices shall be substantial enough to prevent removal without the use of excessive force or unusual techniques, such as with the use of bolt cutters or other metal cutting tools.

(ii) Tagout devices. Tagout devices, including their means of attachment, shall be substantial enough to prevent inadvertent or accidental removal. Tagout device attachment means shall be of a nonreusable type, attachable by hand, self-locking, and nonreleasable with a minimum unlocking strength of no less than 50 pounds and having the general design and basic characteristics of being at least equivalent to a one-piece, all-environment-tolerant nylon cable tie.

(d) Identifiable. Lockout devices and tagout devices shall indicate the identity of the employee applying the device(s):

(3) Tagout devices shall warn against hazardous conditions if the machine or equipment is energized and shall include a legend such as the following: Do not start, do not open, do not close, do not energize, do not operate:)) (1) Release from lockout or tagout.

(a) Before lockout or tagout devices are removed and energy is restored to the machine or equipment, procedures shall be followed and actions taken by the authorized employee(s) to ensure the following:

(b) The machine or equipment. The work area shall be inspected to ensure that nonessential items have been removed and to ensure that machine or equipment components are operationally intact.

(2) Employees.

(a) The work area shall be checked to ensure that all employees have been safely positioned or removed.

(b) After lockout or tagout devices have been removed and before a machine or equipment is started, affected employees shall be notified that the lockout or tagout device(s) have been removed.

(3) Lockout or tagout devices removal. Each lockout or tagout device shall be removed from each energy isolating device by the employee who applied the device. Exception: When the authorized employee who applied the lockout or tagout device is not available to remove it, that device may be removed under the direction of the employer, provided that specific procedures and training for such removal have been developed, documented, and incorporated into the employer's energy control program. The employer shall demonstrate that the specific procedure provides equivalent safety to the removal of the device by the authorized employee who applied it. The specific procedure shall include at least the following elements:

(a) Verification by the employer that the authorized employee who applied the device is not at the facility;

(b) Making all reasonable efforts to contact the authorized employee to inform him/her that his/her lockout or tagout device has been removed; and

(c) Ensuring that the authorized employee has this knowledge before he/she resumes work at that facility.

**AMENDATORY SECTION** (Amending Order 91-01, filed 5/20/91, effective 6/20/91)

WAC 296-24-11011 ((**PERIODIC INSPECTION**)) **ADDITIONAL REQUIREMENTS.** ((+)) The employer shall conduct a periodic inspection of the energy control procedure(s) at least annually to ensure that the procedure and the requirements of this standard are being followed:

(a) The periodic inspection shall be performed by an authorized employee other than the one(s) utilizing the energy control procedure being inspected:

(b) The periodic inspection shall be conducted to correct any deviations or inadequacies identified:

(c) Where lockout is used for energy control, the periodic inspection shall include a review, between the inspector and each authorized employee, of that employee's responsibilities under the energy control procedure being inspected:

(d) Where tagout is used for energy control, the periodic inspection shall include a review, between the inspector and each authorized and affected employee, of that employee's responsibilities under the energy control procedure being inspected, and the elements set forth in WAC 296-24-11013:

(2) The employer shall certify that the periodic inspections have been performed. The certification shall identify the machine or equipment on which the energy control procedure was being utilized, the date of the inspection, the employees included in the inspection, and

the person performing the inspection:)) (1) Testing or positioning of machines, equipment, or components thereof.

In situations in which lockout or tagout devices must be temporarily removed from the energy isolating device and the machine or equipment energized to test or position the machine, equipment or component thereof, the following sequence of actions shall be followed:

(a) Clear the machine or equipment of tools and materials in accordance with WAC 296-24-11009 (1)(b):

(b) Remove employees from the machine or equipment area in accordance with WAC 296-24-11009(2):

(c) Remove the lockout or tagout devices as specified in WAC 296-24-11009(3):

(d) Energize and proceed with testing or positioning;

(e) Deenergize all systems and reapply energy control measures in accordance with WAC 296-24-11007 to continue the servicing and/or maintenance.

(2) Outside personnel (contractors, etc.).

(a) Whenever outside servicing personnel are to be engaged in activities covered by the scope and application of this standard, the on-site employer and the outside employer shall inform each other of their respective lockout or tagout procedures.

(b) The outside employer shall assure that his/her employees understand and comply with the restrictions and prohibitions of the on-site employer's energy control program.

(3) Group lockout or tagout.

(a) When servicing and/or maintenance is performed by a crew, craft, department or other group, they shall utilize a procedure which affords the employees a level of protection equivalent to that provided by the implementation of a personal lockout or tagout device.

(b) Group lockout or tagout devices shall be used in accordance with the procedures required by WAC 296-24-11005(4) including, but not necessarily limited to, the following specific requirements:

(i) Primary responsibility is vested in an authorized employee for a set number of employees working under the protection of a group lockout or tagout device (such as an operations lock);

(ii) Provision for the authorized employee to ascertain the exposure status of individual group members with regard to the lockout or tagout of the machine or equipment; and

(iii) When more than one crew, craft, department, etc., is involved, assignment of overall job-associated lockout or tagout control responsibility to an authorized employee designated to coordinate affected work forces and ensure continuity of protection; and

(iv) Each authorized employee shall affix a personal lockout or tagout device to the group lockout device, group lockbox, or comparable mechanism when he or she begins work, and shall remove those devices when he or she stops working on the machine or equipment being serviced or maintained.

(4) Shift or personnel changes. Specific procedures shall be utilized during shift or personnel changes to ensure the continuity of lockout or tagout protection, including provision for the orderly transfer of lockout or tagout device protection between off-going and oncoming employees, to minimize exposure to hazards from the unexpected energization or start-up of the machine or equipment, or release of stored energy.

**AMENDATORY SECTION** (Amending Order 91-01, filed 5/20/91, effective 6/20/91)

WAC 296-24-11013 ((**TRAINING AND COMMUNICATION**)) **RESERVED.** ((+)) The employer shall provide training to ensure that the purpose and function of the energy control program are understood by employees and that the knowledge and skills required for the safe application, usage, and removal of the energy control devices are acquired by employees. The training shall include the following:

(a) Each authorized employee shall receive training in the recognition of applicable hazardous energy sources, the type and magnitude of the energy available in the workplace, and the methods and means necessary for energy isolation and control:

(b) Each affected employee shall be instructed in the purpose and use of the energy control procedure:

(c) All other employees whose work operations are or may be in an area where energy control procedures may be utilized, shall be instructed about the procedure, and about the prohibition relating to attempts to restart or reenergize machines or equipment which are locked out or tagged out:

(2) When tagout systems are used, employees shall also be trained in the following limitations of tags:

(a) Tags are essentially warning devices affixed to energy isolating devices, and do not provide the physical restraint on those devices that is provided by a lock.

(b) When a tag is attached to an energy isolating means, it is not to be removed without authorization of the authorized person responsible for it, and it is never to be bypassed, ignored, or otherwise defeated.

(c) Tags must be legible and understandable by all authorized employees, affected employees, and all other employees whose work operations are or may be in the area, in order to be effective.

(d) Tags and their means of attachment must be made of materials which will withstand the environmental conditions encountered in the workplace.

(e) Tags may evoke a false sense of security, and their meaning needs to be understood as part of the overall energy control program.

(f) Tags must be securely attached to energy isolating devices so that they cannot be inadvertently or accidentally detached during use.

### (3) Employee retraining.

(a) Retraining shall be provided for all authorized and affected employees whenever there is a change in their job assignments, a change in machines, equipment or processes that present a new hazard, or when there is a change in the energy control procedures.

(b) Additional retraining shall also be conducted whenever a periodic inspection reveals, or whenever the employer has reason to believe, that there are deviations from or inadequacies in the employee's knowledge or use of the energy control procedures.

(c) The retraining shall reestablish employee proficiency and introduce new or revised control methods and procedures, as necessary.

(4) The employer shall certify that employee training has been accomplished and is being kept up to date. The certification shall contain each employee's name and dates of training.)

## AMENDATORY SECTION (Amending Order 91-01, filed 5/20/91, effective 6/20/91)

WAC 296-24-11015 ((SPECIFIC PROCEDURES)) RESERVED. ((†) Energy isolation. Implementation of lockout or the tagout system shall be performed only by authorized/designated employees.

(2) ~~Notification of employees.~~ Affected employees shall be notified by the authorized employer representative of the application and removal of lockout devices or tagout devices. Notification shall be given before the controls are applied, and after they are removed from the machine or equipment.

(3) ~~Application of control.~~ The established procedures for the application of energy control (the lockout or tagout procedures) shall cover the following elements and actions and shall be done in the following sequence:

(a) ~~Preparation for shutdown.~~ Before an authorized or affected employee turns off a machine or equipment, the authorized employee shall have knowledge of the type and magnitude of the energy, the hazards of the energy to be controlled, and the method or means to control the energy.

(b) ~~Machine or equipment shutdown.~~ The machine or equipment shall be turned off or shut down using the procedures established for the machine or equipment. An orderly shutdown must be utilized to avoid any additional or increased hazard(s) to employees as a result of equipment stoppage.

(c) ~~Machine or equipment isolation.~~ All energy isolating devices that are needed to control the energy to the machine or equipment shall be physically located and operated in such a manner as to isolate the machine or equipment from the energy source(s).

### (4) Lockout or tagout device application.

(a) Lockout or tagout devices shall be affixed to each energy isolating device by authorized employees.

(b) Lockout devices, where used, shall be affixed in a manner so that will hold the energy isolating devices in a "safe" or "off" position.

(c) An information tag shall be attached to each lockout point. This tag shall comply with all minimum requirements for tagout devices, see WAC 296-24-11009.

(d) Tagout devices, where used, shall be affixed in such a manner as will clearly indicate that the operation or movement of energy isolating devices from the "safe" or "off" position is prohibited:

(i) Where tagout devices are used with energy isolating devices designed with the capability of being locked, the tag attachment shall be fastened at the same point at which the lock would have been attached. Note: See WAC 296-24-11005.

(ii) Where a tag cannot be affixed directly to the energy isolating device, the tag shall be located as close as safely possible to the device,

in a position that will be immediately obvious to anyone attempting to operate the device.

### (5) Stored energy.

(a) Following the application of lockout or tagout devices to energy isolating devices, all potentially hazardous stored or residual energy shall be relieved, disconnected, restrained, blocked, and otherwise rendered safe.

(b) If there is a possibility of reaccumulation of stored energy to a hazardous level, verification of isolation shall be continued until the servicing or maintenance is completed, or until the possibility of such accumulation no longer exists.

(6) ~~Verification of isolation.~~ Prior to starting work on machines or equipment that have been locked out or tagged out, the authorized employee shall verify that isolation and deenergization of the machine or equipment have been accomplished.

(7) ~~Release from lockout or tagout.~~ Before lockout or tagout devices are removed and energy is restored to the machine or equipment, procedures shall be followed and actions taken by the authorized employee(s) to ensure the following:

(a) The machine or equipment. The work area shall be inspected to ensure that nonessential items have been removed and to ensure that machine or equipment components and guards are operationally intact.

### (b) Employees.

(i) The authorized employee representative shall ensure that the work area is checked to assure that all employees are safely positioned or removed.

(ii) After lockout or tagout devices have been removed and before a machine or equipment is started or energized, affected employees shall be notified that the lockout or tagout device has been removed.

(c) ~~Lockout or tagout devices removal.~~ Each lockout or tagout device shall be removed from each energy isolating device by the employee who applied the device. Exception: When the authorized employee who applied the lockout or tagout device is not available to remove it, that device may be removed under the direction of the employer, provided that specific procedures and training for such removal have been developed, documented, and incorporated into the employer's energy control program. The employer shall demonstrate that the specific procedure provides equivalent safety to the removal of the device by the authorized employee who applied it. The specific procedure shall include at least the following elements:

(i) Verification by the employer that the authorized employee who applied the device is not at the facility;

(ii) Making all reasonable efforts to contact the authorized employee to inform him/her that his/her lockout or tagout device has been removed; and

(iii) Ensuring that the authorized employee has this knowledge before he/she resumes work at that facility.))

## AMENDATORY SECTION (Amending Order 91-01, filed 5/20/91, effective 6/20/91)

WAC 296-24-11017 ((ADDITIONAL REQUIREMENTS)) RESERVED. ((†) Testing or positioning of machines, equipment, or components thereof.

In situations in which lockout or tagout devices must be temporarily removed from the energy isolating device and the machine or equipment energized to test or position the machine, equipment or component thereof, the following sequence of actions shall be followed:

(a) Clear the machine or equipment of tools and materials in accordance with WAC 296-24-11015;

(b) Remove employees from the machine or equipment area in accordance with WAC 296-24-11015;

(c) Remove the lockout or tagout devices as specified in this section;

(d) Energize and proceed with testing or positioning;

(e) Deenergize all systems and reapply energy control measures in accordance with this Part A-4 to continue the servicing and/or maintenance.

### (2) Outside personnel (contractors, etc.):

(a) Whenever outside servicing personnel are to be engaged in activities covered by the scope and application of this standard, the on-site employer and the outside employer shall inform each other of their respective lockout or tagout procedures.

(b) The outside employer shall assure that all outside personnel shall comply with all requirements of the on-site employer's lockout/tagout control program.

(c) Deviations from the on-site employer's control program are not permissible without specific prior approval.

### (3) Group lockout or tagout.

~~(a) When servicing and/or maintenance is performed by a crew, craft, department or other group, they shall utilize a procedure which affords the employees a level of protection equivalent to that provided by the implementation of a personal lockout or tagout device.~~

~~(b) Group lockout or tagout devices shall be used in accordance with the procedures required by this section including, but not necessarily limited to, the following specific requirements:~~

~~(i) Primary responsibility is vested in an authorized employee for all employees working under the protection of a group lockout or tagout device (such as an operations lock); and~~

~~(ii) Provision for the authorized employee to ascertain the exposure status of individual group members with regard to the lockout or tagout of the machine or equipment; and~~

~~(iii) When more than one crew, craft, department, etc., is involved, job-associated lockout or tagout control responsibility shall be assigned to an authorized employee designated to coordinate affected work forces and ensure continuity of protection; and~~

~~(iv) Each authorized employee shall affix a personal lockout or tagout device to the group lockout device, group lockbox, or comparable mechanism when he or she begins work, and shall remove those devices when he or she stops working on the machine or equipment being serviced or maintained.~~

~~(4) Shift or personnel changes. Specific procedures shall be utilized during shift or personnel changes to ensure the continuity of lockout or tagout protection, including provision for the orderly transfer of lockout or tagout device protection between off-going and oncoming employees, to minimize exposure to hazards from the unexpected energization or start-up of the machine or equipment, or release of stored energy.))~~

**AMENDATORY SECTION** (Amending Order 91-01, filed 5/20/91, effective 6/20/91)

WAC 296-24-119 APPENDICES.

APPENDIX A

Appendix A ((is a nonmandatory appendix intended as an illustrative example to assist employers in setting up the company's individual minimum deactivating and control program. Nothing in this appendix is intended to either add or detract from any requirements of this Part A-4)) - **Typical Minimal Lockout Procedure—Nonmandatory.**

(1) General.

((~~1~~)) The following simple lockout procedure is provided to assist employers in developing their procedures so they meet the requirements of this standard. When the energy isolating devices are not lockable, tagout may be used, provided the employer complies with the provisions of the standard which require additional training and more rigorous periodic inspections. When tagout is used and the energy isolating devices are lockable, the employer must provide full employee protection (see WAC 296-24-11005(3)) and additional training and more rigorous periodic inspections are required. For more complex systems, more comprehensive procedures may need to be developed, documented and utilized.

Lockout Procedure

Lockout procedure for

(Name of Company for single procedure or identification of equipment if multiple procedures are used.)

(2) Purpose.

((~~2~~)) This procedure establishes the minimum requirements for the lockout of energy isolating devices whenever maintenance or servicing is done on machines or equipment. It shall be used to ensure that the machine or equipment is stopped, isolated from all potentially hazardous energy sources and locked out before employees perform any servicing or maintenance where the unexpected energization or start-up of the machine or equipment or release of stored energy could cause injury.

(3) Compliance with this program.

(a) All employees are required to comply with the restrictions and limitations imposed upon them during the use of lockout. The authorized employees are required to perform the lockout in accordance with this procedure. All employees, upon observing a machine or piece of equipment which is locked out to perform servicing or maintenance shall not attempt to start, energize or use that machine or equipment.

(b) Type of compliance enforcement to be taken for violation of the above.

(4) Sequence of lockout.

(a) Notify all affected employees that servicing or maintenance is required on a machine or equipment and that the machine or equipment must be shut down and locked out to perform the servicing or maintenance.

Name(s)/job title(s) of affected employees and how to notify.

(b) The authorized employee shall refer to the company procedure to identify the type and magnitude of the energy that the machine or equipment utilizes, shall understand the hazards of the energy, and shall know the methods to control the energy.

Type(s) and magnitude(s) of energy, its hazards and the methods to control the energy.

(c) If the machine or equipment is operating, shut it down by the normal stopping procedure (depress stop button, open switch, close valve, etc.).

Type(s) and location(s) of machine or equipment operating controls.

(d) Deactivate the energy isolating device(s) so that the machine or equipment is isolated from the energy source(s).

Type(s) and location(s) of energy isolating devices.

(e) Lock out the energy isolating device(s) with assigned individual lock(s).

(f) Stored or residual energy (such as that in capacitors, springs, elevated machine members, rotating flywheels, hydraulic systems, and air, gas, steam, or water pressure, etc.) must be dissipated or restrained by methods such as grounding, repositioning, blocking, bleeding down, etc.

Type(s) of stored energy - methods to dissipate or restrain.

(g) Ensure that the equipment is disconnected from the energy source(s) by first checking that no personnel are exposed, then verify the isolation of the equipment by operating the push button or other normal operating control(s) or by testing to make certain the equipment will not operate.

**CAUTION:** Return operating control(s) to neutral or "off" position after verifying the isolation of the equipment.

Method of verifying the isolation of the equipment.

(h) The machine or equipment is now locked out.

(5) Restoring equipment to service.

(a) When the servicing or maintenance is completed and the machine or equipment is ready to return to normal operating condition, the following steps shall be taken.

(b) Check the machine or equipment and the immediate area around the machine or equipment to ensure that nonessential items have been removed and that the machine or equipment components are operationally intact.

(c) Check the work area to ensure that all employees have been safely positioned or removed from the area.

(d) Verify that the controls are in neutral.

(e) Remove the lockout devices and reenergize the machine or equipment.

Note: The removal of some forms of blocking may require reenergization of the machine before safe removal.

(f) Notify affected employees that the servicing or maintenance is completed and the machine or equipment is ready for use.

((APPENDIX B

**RUNNING ADJUSTMENT PROCEDURES—NONMANDATORY APPENDIX**

~~((1)) Running Adjustment Procedures are intended to be limited to applications which require energizing the equipment in order to complete a task which cannot be accomplished while the equipment is locked out. Typical examples could include:~~

~~(a) A machine which must be in motion to make final adjustments of moving elements;~~

~~(b) A machine which must be in motion to remove production materials;~~

~~(c) A machine which must be in motion to "thread-on" new carrier ropes, belts or clothing elements;~~

~~(d) An electrical circuit which must be energized to test for continuity;~~

~~(e) A pipeline system which must be filled for testing or inspection purposes.~~

~~((2)) When standard lockout procedures cannot be used to accomplish the necessary task, the following procedures shall be used to minimize the possibility of personnel exposure:~~

~~(a) The operating control(s) shall only be operated by a qualified operator/craftsman;~~

~~(b) The qualified operator/craftsman shall attend the control(s) at all times when the controls are not locked out;~~

(c) ~~The equipment shall be operated at the slowest speed possible consistent with the task to be performed;~~

(d) ~~All personnel shall remain in view of the person operating the controls or other means of communication shall be established;~~

(e) ~~Extension tools which minimize personnel exposure shall be used where possible;~~

(f) ~~All personnel shall be thoroughly trained in the exact procedure to be followed;~~

(g) ~~All personnel shall be positioned beyond the reach of other machine elements or sections which are not locked out and may offer the potential for exposure. In any instance where a necessary work position offers exposure to other sections or elements of the machine, such other sections shall be locked out before exposure occurs;~~

(h) ~~Anytime that communications are lost between the operator and work crews or anytime that established and authorized procedures cannot be followed, all work offering potential exposure shall be stopped until agreement is reached on exactly how to proceed.~~

APPENDIX C  
GROUP LOCKOUT PROCEDURES  
(aka. ganglock or lockbox procedures)  
NONMANDATORY APPENDIX

(1) Application:

(a) Lockbox procedures are intended and must be designed to provide positive isolation at any identified worksite without the necessity for every workman to apply personal lockout devices on every control device which could otherwise influence his/her individual worksite(s). Lockbox procedures are most useful in applications such as (but not limited to) the following:

(i) Multiple crews/crafts or multiple employers working on same job/machine/system;

(ii) Complex machines/systems with multiple controls, particularly when control locations are broadly spaced out or remote from the actual worksite(s).

(b) The following appendix text is purposely detailed because it has been conclusively established that all items listed need to be addressed in the employer's lockbox control program if the procedure is going to be successful in achieving assured isolation for all potentially influenced personnel:

(2) Program requirements:

(a) The employer's detailed lockbox procedure must be formally produced, employees and supervisors trained and adequate equipment provided prior to permitting any personnel to work under any form of an alternative lockout procedure:

(b) Overall procedural authority and responsibility must be vested in a designated and specifically qualified area supervisor or job lockout coordinator for each shutdown conducted under lockbox procedures:

(c) Each lockbox shutdown shall be conducted with a shutdown checklist. Every control necessary to assure isolation at all permissible worksites must be listed on the checklist. Where numerical identification system is used, controls shall be listed by both identification system and common language name:

(i) The responsible area supervisor, with assistance as necessary, must review the job shutdown checklist to assure that it is accurate and complete before each shutdown:

(ii) Each item on the job lockout checklist shall have boxes or space for the lockout crew to sign off when individual items are deactivated, locked out and tested:

(d) The minimum permissible lockout crew shall be not less than (2) two fully qualified employees:

(i) The job supervisor/designated lockout coordinator must participate as one member of the lockout crew which deactivates, secures and tests each control on the checklist. He/she must at least observe the test sequence on each control:

(ii) Additional qualified employees may be added to the lockout crew as job demands or special circumstances dictate:

(e) When the shutdown job will include work performed by personnel who are not within the owner's full-time employee group (typically service reps, contract mechanics, laborers or engineers), the lockout crew:

(i) Must be supplemented by a specifically designated and qualified supervisor or leadman from each outside employer, or

(ii) The designated control authority (item (2)(b)) must explain the delineated boundaries of the secured equipment to each person before that person can sign in, lock the control box and enter the job.

(f) All lockbox shutdown jobs must be conducted with an everyman control requirement. Each person entering the job must sign the sign-in sheet and apply a personal lockout device on the lockbox before he/she enters the job. Each person must also sign back out and remove their own lockout device when they leave the job for the last time each day:

(i) The designated control authority may leave his/her lock on the lockbox until the job is completed if desired:

(g) Lockbox:

(i) The job lockbox must be constructed so that the lockout keys are visible within the box but cannot be removed without opening the lockbox cover:

(ii) The lockbox cover must be constructed so that any single lock installed on the cover will prevent the keys inside from being removed:

(3) Procedure Sequence:

(a) The sign-in/sign-out sheet(s) shall remain in the possession of the job supervisor/lockout coordinator until the deactivating is complete, the controls locked out and the control keys are securely locked up inside the lockbox:

(b) The lockout crew shall deactivate, lockout and test each control on the job shutdown checklist in full compliance with the standard lockout procedures of this section:

(c) The lockout crew shall individually sign off for each item on the checklist when each item is locked and again when each item has passed the required test sequence to assure that deactivation is complete:

(d) Each listed control shall be locked in the deactivated position by a minimum of two members of the lockout crew except that when the lockout crew is required by this section to be supplemented by a foreman for each outside contractor, each contractor foreman shall also apply an additional lock on each control:

(e) Each person on the lockout crew shall use differently keyed padlocks not combination locks, to implement the lockbox procedures. Series locks may be used provided that no key is available which will open more than one lock on any given control:

(f) Padlocks used shall be individually identified or an information tag identifying the user, shall be attached to the lock:

(g) When all items on the job lockout checklist are deactivated, locked out, tested and signed off, all keys which will open any control padlock used shall be placed inside the job lockbox:

(4) The job supervisor shall then effect the following procedures in the sequence specified:

(a) Review the checklist to ascertain that lockout is complete;

(b) Assure that all keys for the control locks are placed in the lockbox;

(c) Apply a personal identified padlock on the lockbox in a manner to secure all control keys inside;

(d) Sign the checklist approving that the lockout is complete;

(e) Sign and release the sign-in/sign-out sheets to approve personnel entry;

(f) The sign-in/sign-out sheet(s) shall be kept with the job shutdown checkoff list(s) until the job is completed, all personnel have signed out and the equipment/system is authorized for restarting. The checklist and sign-in sheets shall then be returned to the area supervisors office and retained as a record for not less than two (2) years:

(5) Workcrew personnel may only enter the job in accordance with the following procedures:

(a) Each person must apply a personally identified padlock on the lockbox in such a manner that the control keys inside are not removable until your lock is removed;

(b) Review the checklist to assure that the controls influencing your intended work position are locked out and tested;

(c) Individually sign in on the job sign-in sheet;

(d) Work crew personnel must each remove their individual padlocks and personally sign back out when they leave the job:

(6) On locked out jobs which will continue into succeeding shifts, the lockout crew and job supervisor/coordinator shall be relieved in accordance with the following:

(a) When individually keyed and personally identified locks are used on individual machine/system controls, every person on the sign-in sheet must clear the job, sign-out and remove their individual locks off the lockbox. Nobody shall be permitted to re-enter the job until the on-coming lockout crew has locked out all controls in accordance with all requirements of this section, then has provided a new completed checklist and sign-in sheet. Personnel may then lock the new control keys in the lockbox, sign-in and resume work:

(b) When series locks with information tags are used in lieu of personally identified locks on individual machine/system controls, the relief lockout crew and job supervisor/coordinator may relieve their individual counterpart person at the lockbox in accordance with the following procedure:

- (i) Sign-in on the existing job checklist including the date and time;
- (ii) Install a personally identified lock on the lockbox;
- (iii) Each off-going individual shall then line out their name on the checklist, initial the change and record the time. He/she then stands relieved and may remove the time. He/she then stands relieved and may remove their personal lock from the lockbox.

~~CRITERIA. The lockbox must be locked at all times securing all keys for individual controls:~~

~~(iv) When the requirements of this item (6)(b) have been complied with, the locks and information tags on the individual machine/system controls shall not be required to be changed or amended. Retesting individual controls shall not be required and is not recommended.~~

~~(c) The on-coming job supervisor shall sign both the checklist(s) and personnel sign-in sheet(s) indicating the date and time when supervision authority changed.~~

~~(7) When all personal padlocks have been removed from the lockbox and all personnel have signed back out, the job supervisor must sign the checklist(s) and sign-in sheet(s) to authorize reactivating the equipment/system. The supervisors signature shall include the date and time when authorization was granted.))~~

#### AMENDATORY SECTION (Amending Order 86-44, filed 12/26/86)

WAC 296-37-510 SCOPE AND APPLICATION. (1) The requirements included in this vertical chapter shall apply throughout the state wherever (~~commercial~~) diving takes place within the jurisdiction of the department of labor and industries. These requirements shall also be applicable to those diving related and supportive work activities not at the diving site but which have a direct effect on the safety of the diving operations. Examples may include but are not limited to: The supply of breathing air or gas; the supply of materials, equipment or supplies required by this chapter; the maintenance of diving equipment.

(2) This standard applies to diving and related support operations conducted in connection with all types of work and employments, including general industry, construction, ship repairing, shipbuilding, shipbreaking and longshoring. However, this standard does not apply to any diving operation:

(a) Performed solely for instructional purposes, using open-circuit, compressed-air SCUBA and conducted within the no-decompression limits; (~~or~~)

(b) Performed solely for search, rescue, or related public safety purposes by or under the control of a governmental agency; or

~~(c) ((Performed by noncommercial divers whose exposures may be of an entirely different type and whose operations are approved by the department of labor and industries;~~

~~(d)) Governed by 45 CFR Part 46 (Protection of Human Subjects, United States Department of Health, Education, and Welfare and Human Services) or equivalent rules or regulations established by another federal agency, which regulate research, development, or related purposes involving human subjects(;;).~~

~~((e)) (d) Defined as scientific diving and which is under the direction and control of a diving program containing at least the following elements:~~

~~(i) Diving safety manual which includes at a minimum: Procedures covering all diving operations specific to the program; procedures for emergency care, including recompression(~~/decompression~~) and evacuation; and criteria for diver training and certification(;;).~~

~~(ii) Diving control (safety) board, with the majority of its members being active divers, which shall at a minimum have the authority to: Approve and monitor diving projects; review and revise the diving safety manual; assure compliance with the manual; certify the depths to which a diver has been trained; take disciplinary action for unsafe practices; and, assure adherence to the buddy system (a diver is accompanied by and is in continuous contact with another diver in the water) for SCUBA diving.~~

(3) This chapter shall augment the requirements of the general safety and health standard, chapter 296-24 WAC and the general occupational health standard, chapter 296-62 WAC. In instances where this chapter is in direct conflict with the requirements of any general horizontal standard, the requirements of this chapter shall apply.

(4) Hoisting gear used in diving operations shall be inspected and certified as required by chapter 296-56 WAC, safety standards for longshore, stevedore and related waterfront operations.

(5) Application in emergencies. An employer may deviate from the requirements of this standard to the extent necessary to prevent or minimize a situation which is likely to cause death, serious physical harm, or major environmental damage, provided that the employer:

(a) Notifies the assistant director of the department of labor and industries in Olympia or the (~~chief safety inspector~~) regional administrator for the region within 48 hours of the onset of the emergency situation indicating the nature of the emergency and extent of the deviation from the prescribed regulations; and

(b) Upon request from the authority notified, submits such information in writing.

(6) Employer obligation. The employer shall be responsible for compliance with:

(a) All provisions of this standard of general applicability; and

(b) All requirements pertaining to specific diving modes to the extent diving operations in such modes are conducted.

#### AMENDATORY SECTION (Amending Order 86-44, filed 12/26/86)

WAC 296-37-515 DEFINITIONS. As used in this standard, the listed terms are defined as follows:

(1) "Acfm": Actual cubic feet per minute.

(2) "ASME Code or equivalent": ASME (American Society of Mechanical Engineers) Boiler and Pressure Vessel Code, Section VIII, or an equivalent code which the employer can demonstrate to be equally effective.

(3) "ATA": Atmosphere absolute.

(4) "Bell": An enclosed compartment, pressurized (closed bell) or unpressurized (open bell), which allows the diver to be transported to and from the underwater work area and which may be used as a temporary refuge during diving operations.

(5) "Bottom time": The total elapsed time measured in minutes from the time when the diver leaves the surface in descent to the time that the diver begins ascent.

(6) "Bursting pressure": The pressure at which a pressure containment device would fail structurally.

(7) "Cylinder": A pressure vessel for the storage of gases.

(8) "Recompression/decompression chamber": A pressure vessel for human occupancy such as a surface decompression chamber, closed bell, or deep diving system used to decompress divers and to treat decompression sickness.

(9) "Decompression sickness": A condition with a variety of symptoms which may result from gas or bubbles in the tissues of divers after pressure reduction.

(10) "Recompression/decompression table": A profile or set of profiles of depth-time relationships for ascent rates and breathing mixtures to be followed after a specific depth-time exposure or exposures.

(11) "Dive location": A surface or vessel from which a diving operation is conducted.

(12) "Dive-location reserve breathing gas": A supply system of air or mixed-gas (as appropriate) at the dive location which is independent of the primary supply system and sufficient to support divers during the planned decompression.

(13) "Dive team": Divers and support employees involved in a diving operation, including the designated person-in-charge.

(14) "Diver": An employee working in water using underwater apparatus which supplies compressed breathing gas at the ambient pressure.

(15) "Diver-carried reserve breathing gas": A diver-carried supply of air or mixed gas (as appropriate) sufficient under standard operating conditions to allow the diver to reach the surface, or another source of breathing gas, or to be reached by a standby diver.

(16) "Diving mode": A type of diving requiring specific equipment, procedures and techniques (SCUBA, surface-supplied air, or mixed gas).

(17) "Fsw": Feet of seawater (or equivalent static pressure head).

(18) "Heavy gear": Diver-worn deep-sea dress including helmet, breastplate, dry suit, weighted shoes(~~(-and appropriate weights)~~).

(19) "Hyperbaric conditions": Pressure conditions in excess of surface pressure.

(20) "Inwater stage": A suspended underwater platform which supports a diver in the water.

(21) "Liveboating": The practice of supporting a surfaced-supplied air or mixed gas diver from a vessel which is underway.

(22) "Mixed-gas diving": A diving mode in which the diver is supplied in the water with a breathing gas other than air.

(23) "No-decompression limits": The depth-time limits of the "no-decompression limits and repetitive dive group designation table for no-decompression air dives," U.S. Navy Diving Manual or equivalent limits which the employer can demonstrate to be equally effective.

(24) "Psi(g)": Pounds per square inch (gauge).

(25) "Scientific diving" means diving performed solely as a necessary part of a scientific, research, or educational activity by employees whose sole purpose for diving is to perform scientific research tasks. Scientific diving does not include performing any tasks usually associated with commercial diving such as: Placing or removing heavy objects underwater; inspection of pipelines and similar objects; construction; demolition; cutting or welding; or the use of explosives.

(26) "SCUBA diving": A diving mode independent of surface supply in which the diver uses open circuit self-contained underwater breathing apparatus.

(27) "Standby diver": A diver at the dive location properly equipped and available to assist a diver in the water.

(28) "Surface-supplied air diving": A diving mode in which the diver in the water is supplied from the dive location with compressed air for breathing.

(29) "Treatment table": A depth-time and breathing gas profile designed to treat decompression sickness.

(30) "Umbilical": The composite hose bundle between a dive location and a diver or bell, or between a diver and a bell, which supplies the diver or bell with breathing gas, communications, power, or heat as appropriate to the diving mode or conditions, and includes a safety line between the diver and the dive location.

(31) "Volume tank": A pressure vessel connected to the outlet of a compressor and used as an air reservoir.

(32) "Working pressure": The maximum pressure to which a pressure containment device may be exposed under standard operating conditions.

#### AMENDATORY SECTION (Amending Order 81-4, filed 3/17/81)

WAC 296-37-550 SCUBA DIVING. (1) General. Employers engaged in scuba diving shall comply with the following requirements, unless otherwise specified.

(2) Limits. SCUBA diving shall not be conducted:

(a) At depths deeper than 130 fsw;

(b) At depths deeper than 100 fsw or outside the no-decompression limits unless a decompression chamber is ready for use;

(c) Against currents exceeding one knot unless line-tended (~~((this requirement does not preclude work swimming with, rather than against, the current)))~~); or

(d) In enclosed or physically confining spaces unless line-tended.

(3) Procedures. (a) A standby diver shall be available while a diver is in the water.

(b) A diver shall be line-tended from the surface, or accompanied by another diver in the water in continuous visual contact during the diving operations.

(c) A diver shall be stationed at the underwater point of entry when diving is conducted in enclosed or physically confining spaces and shall have positive means of communication with the diver or divers within the space.

(d) A diver-carried reserve breathing gas supply shall be provided for each diver consisting of:

(i) A manual reserve (J valve); or

(ii) An independent reserve cylinder with a separate regulator or connected to the underwater breathing apparatus.

(e) The valve of the reserve breathing gas supply shall be in the closed position prior to the dive.

#### AMENDATORY SECTION (Amending Order 78-18, filed 10/2/78)

WAC 296-37-560 MIXED-GAS DIVING. (1) General. Employers engaged in mixed-gas diving shall comply with the following requirements, unless otherwise specified.

(2) Limits. Mixed-gas diving shall be conducted only when:

(a) A decompression chamber is ready for use at the dive location; and

((††)) (b) A bell is used at depths greater than 220 fsw or when the dive involves inwater decompression time of greater than 120 minutes, except when heavy gear is worn or when diving in physically confining spaces; or

((†††)) (c) A closed bell is used at depths greater than 300 fsw, except when diving is conducted in physically confining spaces.

(3) Procedures.

(a) A separate dive team member shall tend each diver in the water.

(b) A standby diver shall be available while a diver is in the water.

(c) A diver shall be stationed at the underwater point of entry when diving is conducted in enclosed or physically confining spaces.

(d) Each diving operation shall have a primary breathing gas supply sufficient to support divers for the duration of the planned dive including decompression.

(e) Each diving operation shall have a dive-location reserve breathing gas supply.

(f) When heavy gear is worn:

(i) An extra breathing gas hose capable of supplying breathing gas to the diver in the water shall be available to the standby diver; and

(ii) An inwater stage shall be provided to divers in the water.

(g) An inwater stage shall be provided for divers without access to a bell for dives deeper than 100 fsw or outside the no-decompression limits.

(h) When a closed bell is used, one dive team member in the bell shall be available and tend the diver in the water.

(i) Except when heavy gear is worn or where physical space does not permit, a diver-carried reserve breathing gas supply shall be provided for each diver:

(i) Diving deeper than 100 fsw or outside the no-decompression limits; or

(ii) Prevented by the configuration of the dive area from directly ascending to the surface.

#### AMENDATORY SECTION (Amending Order 86-44, filed 12/26/86)

WAC 296-37-565 LIVEBOATING. (1) General. Employers engaged in diving operations involving liveboating shall comply with the following requirements.

(2) Limits. Diving operations involving liveboating shall not be conducted:

(a) (~~(Liveboating:))~~ With an inwater decompression time of greater than ((30)) 120 minutes;

(b) Using surface-supplied air at depths deeper than 190 fsw, except that dives with bottom times of 30 minutes or less may be conducted to depths of 220 fsw;

(c) Using mixed gas at depths greater than 220 fsw;

(d) In rough seas which significantly impede diver mobility or work function; or

(e) In other than daylight hours.

(3) Procedures.

(a) The propeller of the vessel shall be stopped before the diver enters or exits the water.

(b) A device shall be used which minimizes the possibility of entanglement of the diver's hose in the propeller of the vessel.

(c) Two-way voice communication between the designated person-in-charge and the person controlling the vessel shall be available while the diver is in the water.

(d) A standby diver shall be available while a diver is in the water.

(e) A diver-carried reserve breathing gas supply shall be carried by each diver engaged in liveboating operations.

#### AMENDATORY SECTION (Amending Order 86-44, filed 12/26/86)

WAC 296-37-570 EQUIPMENT. (1) General.

(a) All employers shall comply with the following requirements, unless otherwise specified.

(b) Each equipment modification, repair, test, calibration or maintenance service shall be recorded by means of a tagging or logging system, and include the date and nature of work performed, and the name or initials of the person performing the work.

(2) Air compressor system((s)).

(a) Compressors used to supply air to the diver shall be equipped with a volume tank with a check valve on the inlet side, a pressure gauge, a relief valve, and a drain valve.

(b) A compressor shall be constructed and situated so as to avoid entry of contaminated air into the air-supply system and shall be equipped with a suitable in-line particulate filter followed by a bed of activated charcoal and, if necessary, a moisture absorber to further assure breathing air quality. These filters should be placed before any receiver and after the discharge in the compressor. If an oil-lubricated



compressor is used, it shall be equipped with a carbon monoxide alarm or an equally as effective alternative if approved by the department.

(i) If a carbon monoxide alarm is used, it shall be calibrated to activate at or below 20 parts per million carbon monoxide at least once per month. A calibration and maintenance log shall be kept and shall be available for review and copying by the director or his or her designee. The log shall identify the test method, date, time of test, results, and the name of the person performing the test. The log shall be retained for at least one year from the date of the test.

(ii) If the use of an alarm at the compressor will not effectively provide warning to the diver or tender of a carbon monoxide problem, a remote alarm or other means of warning the wearer shall be used.

(iii) Breathing air couplings shall be incompatible with outlets for nonrespirable plant air or other gas systems to prevent inadvertent servicing of air-line breathing apparatus with nonrespirable gases.

(c) Respirable air supplied to a diver shall not contain:

- (i) A level of carbon monoxide (CO) greater than 20 ppm;
- (ii) A level of carbon dioxide (CO<sub>2</sub>) greater than 1,000 ppm;
- (iii) A level of oil mist greater than 5 milligrams per cubic meter; or
- (iv) A noxious or pronounced odor.

(d) Compressor systems providing surface air to divers must have a low pressure warning device installed at the air purification system inlet to alert dive tenders of low air pressure.

The minimum alarm setting shall be 45 Psi plus an additional 15 Psi for each working atmosphere.

1 ATM = 33 fsw or 15 Psi

2 ATM = 66 fsw or 30 Psi

3 ATM = 99 fsw or 45 Psi

4 ATM = 132 fsw or 60 Psi

5 ATM = 165 fsw or 75 Psi

6 ATM = 198 fsw or 90 Psi

(e) The output of air compressor systems shall be tested for air purity every six months by means of samples taken at the connection to the distribution system, except that nonoil lubricated compressors need not be tested for oil mist.

(3) Breathing gas supply hoses.

(a) Breathing gas supply hoses shall:

(i) Have a working pressure at least equal to the working pressure of the total breathing gas system;

(ii) Have a rated bursting pressure at least equal to four times the working pressure;

(iii) Be tested at least annually to 1.5 times their working pressure; and

(iv) Have their open ends taped, capped or plugged when not in use.

(b) Breathing gas supply hose connectors shall:

(i) Be made of corrosion-resistant materials;

(ii) Have a working pressure at least equal to the working pressure of the hose to which they are attached; and

(iii) Be resistant to accidental disengagement.

(c) Umbilicals shall:

(i) Include a safety line which shall be attached in a manner to remove strain from the air supply hose;

(ii) Be marked in 10-foot increments to 100 feet beginning at the diver's end, and in 50 foot increments thereafter;

(iii) Be made of kink-resistant materials; and

(iv) Have a working pressure greater than the pressure equivalent to the maximum depth of the dive (relative to the supply source) plus 100 psi.

(4) Buoyancy control.

(a) Helmets or masks connected directly to the dry suit or other buoyancy-changing equipment shall be equipped with an exhaust valve.

(b) A dry suit or other buoyancy-changing equipment not directly connected to the helmet or mask shall be equipped with an exhaust valve.

(c) When used for SCUBA diving, a buoyancy compensator shall have an inflation source separate from the breathing gas supply.

(d) An inflatable flotation device capable of maintaining the diver at the surface in a face-up position, having a manually activated inflation source independent of the breathing supply, an oral inflation device, and an exhaust valve shall be used for SCUBA diving.

(5) Compressed gas cylinders. ((†)) Compressed gas cylinders shall:

((†)) (a) Be designed, constructed and maintained in accordance with the applicable provisions of ((WAC 296-24-920 through 296-24-94003)) WAC 296-24-295 and 296-24-940 of the General safety and health standards.

((††)) (b) Be stored in a ventilated area and protected from excessive heat;

((†††)) (c) Be secured from falling; and

((†††)) (d) Have shut-off valves recessed into the cylinder or protected by a cap, except when in use or manifolded, or when used for SCUBA diving.

(6) Recompression/decompression chambers.

(a) Each recompression/decompression chamber manufactured after the effective date of this standard, shall be built and maintained in accordance with the ASME Code or equivalent.

(b) Each recompression/decompression chamber manufactured prior to the effective date of this standard shall be maintained in conformity with the code requirements to which it was built, or equivalent.

(c) Each recompression/decompression chamber shall be equipped with:

(i) Means to maintain the atmosphere below a level of 25% oxygen by volume;

(ii) Mufflers on intake and exhaust lines, which shall be regularly inspected and maintained;

(iii) Suction guards on exhaust line openings; and

(iv) A means for extinguishing fire, and shall be maintained to minimize sources of ignition and combustible material.

(7) Gauges and timekeeping devices.

(a) Gauges indicating diver depth which can be read at the dive location shall be used for all dives except SCUBA.

(b) Each depth gauge shall be ((~~dead-weight~~)) deadweight tested or calibrated against a master reference gauge every six months, and when there is a discrepancy greater than two percent of full scale between any two equivalent gauges.

(c) A cylinder pressure gauge capable of being monitored by the diver during the dive shall be worn by each SCUBA diver.

(d) A timekeeping device shall be available at each dive location.

(8) Masks and helmets.

(a) Surface-supplied air and mixed-gas masks and helmets shall have:

(i) A nonreturn valve at the attachment point between helmet or mask and hose which shall close readily and positively; and

(ii) An exhaust valve.

(b) Surface-supplied air masks and helmets shall have a minimum ventilation rate capability of 4.5 acfm at any depth at which they are operated or the capability of maintaining the diver's inspired carbon dioxide partial pressure below 0.02 ATA when the diver is producing carbon dioxide at the rate of 1.6 standard liters per minute.

(9) Oxygen safety.

(a) Equipment used with oxygen or mixtures containing over forty percent (40%) by volume oxygen shall be designed for oxygen service.

(b) Components (except umbilicals) exposed to oxygen or mixtures containing over forty percent (40%) by volume oxygen shall be cleaned of flammable materials before use.

(c) Oxygen systems over 125 psig and compressed air systems over 500 psig shall have slow-opening shut-off valves.

(10) Weights and harnesses.

(a) Except when heavy gear is worn, divers shall be equipped with a weight belt or assembly capable of quick release.

(b) Except when heavy gear is worn or in SCUBA diving, each diver shall wear a safety harness with:

(i) A positive buckling device;

(ii) An attachment point for the umbilical to prevent strain on the mask or helmet; and

(iii) A lifting point to distribute the pull force of the line over the diver's body.

#### AMENDATORY SECTION (Amending Order 86-44, filed 12/26/86)

WAC 296-37-575 RECORDKEEPING REQUIREMENTS. (1) Recording and reporting.

(a) The employer shall ((~~record and report occupational injuries and illnesses in accordance~~)) comply with the requirements of chapters 296-27 and 296-350 WAC.

(b) The employer shall record the occurrence of any diving-related injury or illness which requires any dive team member to be hospitalized for 24 hours or more, specifying the circumstances of the incident and the extent of any injuries or illnesses.

(2) Availability of records.

(a) Upon the request of the director of the department of labor and industries or his duly authorized designees, the employer shall make available for inspection and copying any record or document required

by this standard.

~~((Note: Requests for information or copies of records and reports by OSHA or NIOSH shall be made to the director of the department of labor and industries.))~~

(b) Records and documents required by this standard shall be provided upon request to employees, designated representatives, and the assistant director in accordance with WAC 296-62-05201 through 296-62-05209 and 296-62-05213 through 296-62-05217. Safe practices manuals (WAC 296-37-530), depth-time profiles (WAC 296-37-540), recording of dives (WAC 296-37-545), ~~((recompression/))~~ decompression procedure assessment evaluations (WAC 296-37-545), and records of hospitalizations (WAC 296-37-575) shall be provided in the same manner as employee exposure records or analyses using exposure or medical records. Equipment inspections and testing records which pertain to employees (WAC 296-37-570) shall also be provided upon request to employees and their designated representatives.

(c) Records and documents required by this standard shall be retained by the employer for the following period:

(i) Dive team member medical records (physician's reports) (WAC 296-37-525) - five years;

(ii) Safe practices manual (WAC 296-37-530) - current document only;

(iii) Depth-time profile (WAC 296-37-540) - until completion of the recording of dive, or until completion of ~~((recompression/))~~ decompression procedure assessment where there has been an incident of decompression sickness;

(iv) Recording dive (WAC 296-37-545) one year, except five years where there has been an incident of decompression sickness;

(v) ~~((Recompression/))~~ Decompression procedure assessment evaluations (WAC 296-37-545) - five years;

(vi) Equipment inspections and testing records (WAC 296-37-570) - current entry or tag, or until equipment is withdrawn from service;

(vii) Records of hospitalizations (WAC 296-37-575) - five years.

(d) After the expiration of the retention period of any record required to be kept for five years, the employer shall forward such records to the National Institute for Occupational Safety and Health, Department of Health and Human Services. The employer shall also comply with any additional requirements set forth in WAC 296-62-05215.

~~((Note: Forward the records to the following address:  
National Institute for Occupational  
— Safety and Health  
Department of Health and Human Services  
Surveillance Branch  
Mail Stop R-18 Ridge  
PHS-CDC-NIOSH  
4676 Columbia Park Way  
Cincinnati, Ohio 45226))~~

(e) In the event the employer ceases to do business:

(i) The successor employer shall receive and retain all dive and employee medical records required by this standard; or

(ii) If there is no successor employer, dive and employee medical records shall be forwarded to the National Institute for Occupational Safety and Health, Department of Health ~~((and Human Services)),~~ Education, and Welfare.

#### AMENDATORY SECTION (Amending Order 78-18, filed 10/2/78)

WAC 296-37-580 ~~((EFFECTIVE DATE))~~ RESERVED. ~~((This standard shall be effective 30 days after being filed with the code reviser.))~~

#### AMENDATORY SECTION (Amending Order 78-18, filed 10/2/78)

WAC 296-37-585 APPENDIX A TO CHAPTER 296-37 WAC—EXAMPLES OF CONDITIONS WHICH MAY RESTRICT OR LIMIT EXPOSURE TO HYPERBARIC CONDITIONS. (1) The following disorders may restrict or limit occupational exposure to hyperbaric conditions depending on severity, presence of residual effects, response to therapy, number of occurrences, diving mode, or degree and duration of isolation.

(a) History of seizure disorder other than early febrile convulsions.  
(b) Malignancies (active) unless treated and without recurrence for five years.

(c) Chronic inability to equalize sinus and/or middle ear pressure.

(d) Cystic or cavitory disease of the lungs.

(e) Impaired organ function caused by alcohol or drug use.

(f) Conditions requiring continuous medication for control (e.g., antihistamines, steroids, barbiturates, mood altering drugs, or insulin).

(i) Meniere's disease.

(ii) Hemoglobinopathies.

(iii) Obstructive or restrictive lung disease.

(iv) Vestibular end organ destruction.

(v) Pneumothorax.

(vi) Cardiac abnormalities (e.g., pathological heart block, valvular disease, intraventricular conduction defects other than isolated right bundle branch block, angina pectoris, arrhythmia, coronary artery disease).

(vii) Juxta-articular osteonecrosis.

#### NEW SECTION

WAC 296-37-590 APPENDIX B TO CHAPTER 296-37 WAC—GUIDELINES FOR SCIENTIFIC DIVING. This appendix contains guidelines that will be used in conjunction with WAC 296-37-510 (2)(e) to determine those scientific diving programs which are exempt from the requirements for commercial diving. The guidelines are as follows:

(1) The diving control board consists of a majority of active scientific divers and has autonomous and absolute authority over scientific diving program's operations.

(2) The purpose of the project using scientific diving is the advancement of science; therefore, information and data resulting from the project are nonproprietary.

(3) The tasks of a scientific diver are those of an observer and data gatherer. Construction and trouble-shooting tasks traditionally associated with commercial diving are not included within scientific diving.

(4) Scientific divers, based on the nature of their activities, must use scientific expertise in studying the underwater environment and, therefore, are scientists or scientists in training.

#### AMENDATORY SECTION (Amending Order 91-07, filed 11/22/91, effective 12/24/91)

WAC 296-56-60001 SCOPE AND APPLICABILITY. (1) The rules included in this chapter apply throughout the state of Washington, to any and all waterfront operations under the jurisdiction of the department of labor and industries, division of industrial safety and health.

(2) These minimum requirements are promulgated in order to augment the general safety and health standards, and any other safety and health standards promulgated by the department of labor and industries which are applicable to all places of employment under the jurisdiction of the department of labor and industries. The rules of this chapter, and the rules of chapters 296-24 and 296-62 WAC are applicable to all longshore, stevedore and related waterfront operations: PROVIDED, That such rules shall not be applicable to those operations under the exclusive safety jurisdiction of the federal government.

(3) The provisions of this chapter shall prevail in the event of a conflict with, or duplication of, provisions contained in chapters 296-24 and 296-62 WAC. Specific standards which are applicable include, but are not limited to:

(a) Electrical—Chapter 296-24 WAC Part L.

(b) Toxic and hazardous substances are regulated by chapter 296-62 WAC. Where references to this chapter are given they are for informational purposes only. Where specific requirements of this chapter conflict with the provisions of chapter 296-62 WAC this chapter prevails. Chapter 296-62 WAC does not apply when a substance or cargo is contained within a manufacturer's original, sealed, intact means of packaging or containment complying with the department of transportation or International Maritime Organization requirements.

(c) Hearing conservation—Chapter 296-62 WAC Part K.

(d) Standards for commercial diving operations—Chapter 296-37 WAC.

(e) Safety requirements for scaffolding—Chapter 296-24 WAC Part J-1.

(f) Safe practices of abrasive blasting operations—Chapter 296-24 WAC Part H-2.

(g) Access to employee exposure and medical records—Chapter 296-62 WAC Part B.

(h) Respiratory protection—Chapter 296-62 WAC Part E.

(i) Safety standards for grain handling facilities—Chapter 296-99 WAC.

(j) Hazard communication purpose—Chapter 296-62 WAC Part C.

(k) Asbestos—Chapters 296-62 Part I-1 and 296-65 WAC.



(l) Confined space—Chapter 296-62 WAC Part M.

(m) Servicing multi-piece and single-piece rim wheels—Chapter 296-24 WAC Part D.

(4) The provisions of this chapter do not apply to the following:

(a) Fully automated bulk coal handling facilities contiguous to electrical power generating plants.

(b) Facilities subject to the regulations of the office of pipeline safety regulation of the materials transportation bureau, department of transportation, to the extent such regulations apply.

**AMENDATORY SECTION** (Amending Order 86-02, filed 1/17/86)

WAC 296-56-60005 DEFINITIONS. (1) "Apron" means that open portion of a marine terminal immediately adjacent to a vessel berth and used in the direct transfer of cargo between the terminal and vessel.

(2) "Assistant director for the division of industrial safety and health" means the assistant director of industrial safety and health, department of labor and industries or his authorized representative.

(3) "Authorized," in reference to an employee's assignment, means selected by the employer for that purpose.

(4) "Cargo door" (transit shed door) means a door designed to permit transfer of cargo to and from a marine terminal structure.

(5) "Cargo packaging" means any method of containment for shipment, including cases, cartons, crates and sacks, but excluding large units such as intermodal containers, vans or similar devices.

(6) "Confined space" means any space having a limited means of egress which is subject to the accumulation of toxic or flammable contaminants or an oxygen deficient atmosphere. Confined spaces include, but are not limited to, intermodal tank containers, brailwater tanks, bins, storage tanks, boilers, ventilation or exhaust ducts, tunnels, and portable tanks.

(7) "Conveyor" means a device designed exclusively for transporting bulk materials, packages or objects in a predetermined path and having fixed or selective points of loading or discharge.

(8) "Danger zone" means any place in or about a machine or piece of equipment where an employee may be struck by or caught between moving parts, caught between moving and stationary objects or parts of the machine, caught between the material and a moving part of the machine, burned by hot surfaces or exposed to electric shock. Examples of danger zones are nip and shear points, shear lines, drive mechanisms, and areas beneath counterweights.

(9) "Designated person" means a person who possesses specialized abilities in a specific (~~capacity~~) area and is assigned by the employer to perform a specific task in that area.

(10) "Dock" means a wharf or pier forming all or part of a waterfront facility, including marginal or quayside berthing facilities; not to be confused with "loading dock" as at a transit shed or container freight station, or with the body of water between piers or wharves.

(11) "Dock facilities" includes all piers, wharves, sheds, aprons, dolphins, cranes, or other gear or equipment owned or controlled by the dock or facility owner, where cargo or materials are loaded, moved or handled to or from a vessel.

(12) "Dockboard" (bridge plate or car plate) means a device utilized to span the gap between railroad cars, or between railroad cars or highway vehicles and the loading dock or platform. A car plate may be fixed, adjustable, portable, powered, or unpowered.

(13) "Enclosed space" means an indoor space, other than a confined space, that may contain or accumulate a hazardous atmosphere due to inadequate natural ventilation. Examples of enclosed spaces (~~include~~) are trailers, railcars, and storage rooms.

(14) "Examination," as applied to material handling devices required to be certified by this chapter, means a comprehensive survey consisting of the criteria outlined in WAC 296-56-60093 through 296-56-60097. The examination is supplemented by a unit proof test in the case of annual survey.

(15) "Flammable atmosphere" means an atmosphere containing more than ten percent of the lower (~~explosive~~) flammable limit (LEL) of a flammable or combustible vapor or dust mixed with air. Such atmospheres are usually toxic as well as flammable.

(16) "Front-end attachments."

(a) As applied to power-operated industrial trucks, means the various devices, such as roll clamps, rotating and sideshifting carriages, magnets, rams, crane arms or booms, load stabilizers, scoops, buckets, and dumping bins, attached to the load end for handling lifts as single or multiple units.

(b) As applied to cranes, means various attachments applied to the basic machine for the performance of functions such as lifting, clamshell or magnet services.

(17) "Fumigant" is a substance or mixture of substances, used to kill pests or prevent infestation, which is a gas or is rapidly or progressively transformed to the gaseous state even though some nongaseous or particulate matter may remain and be dispersed in the treatment space.

(18) "Hazardous cargo, material, substance or atmosphere" means:

(a) Any substance listed in chapter 296-62 WAC;

(b) Any material in the hazardous materials table and hazardous materials communications regulations of the Department of Transportation, 49 CFR Part 172;

(c) Any article not properly described by a name in the hazardous materials table and hazardous materials communications regulations of the Department of Transportation, 49 CFR Part 172, but which is properly classified under the definition of those categories of dangerous articles given in 49 CFR Part 173;

(d) Atmospheres having concentrations of airborne chemicals in excess of permissible exposure limits as defined in chapter 296-62 WAC; or

(e) Any atmosphere with an oxygen content of less than nineteen and one-half percent by volume.

(19) "House falls" means spans and supporting members, winches, blocks, and standing and running rigging forming part of a marine terminal and used with a vessel's cargo gear to load or unload by means of married falls.

(20) "Inspection," as applied to material handling devices required to be certified by this chapter, includes a complete visual examination of all visible parts of the device.

(21) "Intermodal container" means a reusable cargo container of rigid construction and rectangular configuration intended to contain one or more articles of cargo or bulk commodities for transportation by water and one or more other transport modes without intermediate cargo handling. The term includes completely enclosed units, open top units, fractional height units, units incorporating liquid or gas tanks and other variations fitting into the container system, (~~demounted~~) demountable or with attached wheels. It does not include cylinders, drums, crates, cases, cartons, packages, sacks, unitized loads or any other form of packaging.

(22) "Loose gear" means removable or replaceable components of equipment or devices which may be used with or as a part of assembled material handling units for purposes such as making connections, changing line direction and multiplying mechanical advantage. Examples include shackles and snatch blocks.

(23) "Marina" means a small harbor or boat basin providing dockage, supplies, and services for small craft.

(24) "Marine terminal" means wharves, bulkheads, quays, piers, docks and other berthing locations and adjacent storage or contiguous areas and structures associated with the primary movement of cargo or materials from vessel to shore or shore to vessel. It includes structures which are devoted to receiving, handling, holding, consolidation, loading or delivery of waterborne shipments and passengers, and areas devoted to the maintenance of the terminal or equipment. The term does not include production or manufacturing areas having their own docking facilities and located at a marine terminal nor storage facilities directly associated with those production or manufacturing areas.

**AMENDATORY SECTION** (Amending Order 86-02, filed 1/17/86)

WAC 296-56-60007 HOUSEKEEPING. (1) Active work areas shall be kept free of equipment and materials not in use, and clear of debris, projecting nails, strapping and other sharp objects not necessary for the work in progress.

(2) Hatch beams, covers, and pontoons placed in terminal working areas shall be stowed in stable piles with beams secured against tipping or falling. Alternatively, beams may be laid on their sides. When beams and pontoons are stowed in tiers more than one high, dunnage or other suitable material shall be used under and between tiers.

(3) Cargo and material shall not obstruct access to vessels, cranes, vehicles, or buildings. Means of access and egress within buildings shall be unobstructed.

(4) The employer shall eliminate, to the extent possible, conditions causing slippery working or walking surfaces in immediate work areas used by employees.

**AMENDATORY SECTION** (Amending Order 86-02, filed 1/17/86)

WAC 296-56-60041 LOG HANDLING. (1) The employer shall ensure that structures (bunks) used to contain logs have rounded corners and rounded structural parts to avoid sling damage.

(2) Two or more binders or equivalently safe means of containment shall remain on logging trucks and railcars to secure logs during movement of the truck or car within the terminal. During unloading, logs shall be prevented from moving while binders are being removed.

(3) Logs shall be hoisted by two slings or by other gear designed for safe hoisting.

(4) Logs placed adjacent to vehicle curbs on the dock shall not be over one tier high unless placed in bunks or (~~retained to prevent rolling~~) so stacked as not to roll or otherwise creating a hazard to employees.

(5) Before logs are slung up from the dock, they shall be stably supported to prevent spreading and to allow passage of slings beneath the load. When bunks or similar retaining devices are used, no log shall be higher than the stanchions or retaining members of the device.

(6) A draft of logs for hoisting aboard ship shall not vary in length more than twenty percent.

(7) Audible alarms.

(a) All bidirectional machines, shall be equipped with a horn, distinguishable from the surrounding noise level, which shall be operated as needed when the machine is moving in either direction. The horn shall be maintained in operable condition.

(b) Automatic back-up alarms shall be installed on bidirectional equipment used to handle logs or containers and shall be maintained in operable condition.

**AMENDATORY SECTION** (Amending Order 86-02, filed 1/17/86)

WAC 296-56-60043 MOVEMENT OF BARGES AND RAILCARS. Barges and railcars shall not be moved by cargo runners (running rigging) from vessel cargo booms, cranes or other equipment not (~~designed~~) suitable for the purpose.

**AMENDATORY SECTION** (Amending Order 86-02, filed 1/17/86)

WAC 296-56-60053 HAZARDOUS ATMOSPHERES AND SUBSTANCES. (1) Purpose and scope. This section covers areas where a hazardous atmosphere or substance may exist, except where one or more of the following sections apply: WAC 296-56-60049 Hazardous cargo; WAC 296-56-60051 Handling explosives or hazardous materials; WAC 296-56-60055 Carbon monoxide; WAC 296-56-60057 Fumigants, pesticides, insecticides and hazardous preservatives; WAC 296-56-60107 Terminal facilities handling menhaden and similar species of fish; WAC 296-56-60235 Welding, cutting and heating (hot work); and WAC 296-56-60237 Spray painting.

(2) Determination of hazard.

(a) Whenever a room, building, vehicle, railcar or other space contains or has contained a hazardous atmosphere, a designated and appropriately equipped person shall test the atmosphere before entry to determine whether a hazardous atmosphere exists.

(b) Records of results of any tests required by this section shall be maintained for at least thirty days.

(3) Testing during ventilation. When mechanical ventilation is used to maintain a safe atmosphere, tests shall be made by a designated person to ensure that the atmosphere is not hazardous.

(4) Entry into hazardous atmospheres. Only designated persons shall enter hazardous atmospheres. The following provisions shall apply:

(a) Persons entering a space containing a hazardous atmosphere shall be protected by respiratory and emergency protective equipment meeting the requirements of WAC 296-62-071 through 296-62-07121;

(b) Persons entering a space containing a hazardous atmosphere shall be instructed in the nature of the hazard, precautions to be taken, and the use of protective and emergency equipment. Standby observers, similarly equipped and instructed, shall continuously monitor the activity of employees within such space; and

(c) Except for emergency or rescue operations, employees shall not enter into any atmosphere which has been identified as flammable or oxygen deficient (less than nineteen and one-half percent oxygen). Persons who may be required to enter flammable or oxygen deficient atmospheres in emergency operations shall be instructed in the dangers attendant to those atmospheres and instructed in the use of self-contained breathing apparatus, which shall be utilized.

(d) To prevent inadvertent employee entry into spaces that have been identified as having hazardous, flammable or oxygen deficient atmospheres, appropriate warning signs or equivalent means shall be posted at all means of access to those spaces.

(5) When the packaging of asbestos cargo leaks, spillage shall be cleaned up by designated employees protected from the harmful effects of asbestos as required by WAC 296-62-07517 and chapter 296-65 WAC.

**AMENDATORY SECTION** (Amending Order 86-02, filed 1/17/86)

WAC 296-56-60057 FUMIGANTS, PESTICIDES, INSECTICIDES AND HAZARDOUS PRESERVATIVES. (1) Whenever cargo in a space is or has been stowed, handled, or treated with a fumigant, pesticide, insecticide, or hazardous preservative, a determination shall be made as to whether a hazardous atmosphere is present in the space. Only employees protected as required in subsection (5) of this section shall enter the space if it is hazardous.

(2) Tests to determine the atmospheric concentration of chemicals used to treat cargo shall be:

(a) Appropriate for the hazard involved;

(b) Conducted by designated persons; and

(c) Performed at the intervals necessary to ensure that employee exposure does not exceed the permissible exposure limit for the chemical involved, see chapter 296-62 WAC.

(3) Results of any tests shall be available for at least thirty days.

(4) Chemicals shall only be applied to cargoes by designated persons.

(5) Only designated persons shall enter hazardous atmospheres. Whenever a hazardous atmosphere is entered the following provisions apply.

(a) Persons entering a space containing a hazardous atmosphere shall be protected by respiratory and emergency protective equipment meeting the requirements of (~~WAC 296-62-071 through 296-62-07121~~) subpart G of this standard; and

(b) Persons entering a space containing a hazardous atmosphere shall be instructed in the nature of the hazard, precautions to be taken, and the use of protective and emergency equipment. Standby observers, similarly equipped and instructed, shall continuously monitor the activity of employees within such a space.

(6) Signs shall be clearly posted where fumigants, pesticides or hazardous preservatives have created a hazardous atmosphere. These signs shall note the danger, identify specific chemical hazards, and give appropriate information and precautions, including instructions for the emergency treatment of employees affected by any chemical in use.

**AMENDATORY SECTION** (Amending Order 91-01, filed 5/20/91, effective 6/20/91)

WAC 296-56-60073 MISCELLANEOUS AUXILIARY GEAR. (1) Routine inspection.

(a) At the completion of each use, loose gear such as slings, chains, bridles, blocks, and hooks shall be so placed as to avoid damage to the gear. Loose gear shall be inspected and any defects corrected before re-use.

(b) All loose gear shall be inspected by the employer or his authorized representative before each use and, when necessary, at intervals during its use, to ensure that it is safe. Any gear which is found upon inspection to be unsafe shall not be used until it is made safe.

(c) Defective gear shall not be used. Distorted hooks, shackles, or similar gear shall be discarded.

(d) Chains or other gear which have been lengthened, altered, or repaired by welding shall be properly heat treated, and before again being put into use, shall be tested and reexamined in the manner set forth in WAC 296-56-60097 and 296-56-60098.

(2) The employer shall maintain a record of the dates and results of the tests with each unit of gear concerned clearly identified. The records shall be available for examination by division of industrial safety and health personnel and the employee safety committee.

(3) Wire rope and wire rope slings.

(a) (~~Four by twenty-nine (4 x 29) wire rope shall not be used in any running rigging.~~

(b)) The employer shall ascertain and adhere to the manufacturer's recommended ratings for wire rope and wire rope slings and shall have such ratings available at the terminal. When the manufacturer is unable to supply such ratings, the employer shall use the tables for wire rope and wire rope slings found in American National Safety Standard for Slings, ANSI/ASME B30.9-1984. A design safety factor of at

least five shall be maintained for the common sizes of running wire used as falls, in purchases or in such uses as light load slings. Wire rope with a safety factor of less than five may be used only:

(i) In specialized equipment, such as cranes designed to be used with lesser wire rope safety factors;

(ii) In accordance with design factors in standing rigging applications; or

(iii) For heavy lifts or other purposes for which a safety factor of five is impractical and for which the employer can demonstrate that equivalent safety is ensured.

((+)) (b) Wire rope or wire rope slings exhibiting any of the following conditions shall not be used:

(i) Ten randomly distributed broken wires in one rope lay or three or more broken wires in one strand in one rope lay;

(ii) Kinking, crushing, bird caging, or other damage resulting in distortion of the wire rope structure;

(iii) Evidence of heat damage;

(iv) Excessive wear, corrosion, deformation or other defect in the wire or attachments, including cracks in attachments;

(v) Any indication of strand or wire slippage in end attachments; or

(vi) More than one broken wire in the close vicinity of a socket or swaged fitting.

(c) Four by twenty-nine (4 x 29) wire rope shall not be used in any running rigging.

(d) Protruding ends of strands in splices on slings and bridles shall be covered or blunted. Coverings shall be removable so that splices can be examined. Means used to cover or blunt ends shall not damage the wire.

(e) Where wire rope clips are used to form eyes, the employer shall adhere to the manufacturer's recommendations, which shall be available at the terminal. If "U" bolt clips are used and the manufacturer's recommendations are not available, Table C-1 shall be used to determine the number and spacing of clips. "U" bolts shall be applied with the "U" section in contact with the dead end of the rope.

Where substituted for manila rope of three inches or more in circumference, the size of the synthetic rope shall be determined from the formula:

$$C = \sqrt{.6(C_s^2) + .4(C_m^2)}$$

Where C = the required circumference of the synthetic rope in inches, C<sub>s</sub> = the circumference to the nearest one-quarter inch of a synthetic rope having a breaking strength not less than that of the size manila rope that would be required by subsection (4) of this section, and C<sub>m</sub> = the circumference of manila rope in inches which would be required by subsection (4) of this section. In making such substitution, it shall be ascertained that the inherent characteristics of the synthetic fiber are suitable for hoisting.

(6) Removal of natural and synthetic rope from service. Natural or synthetic rope having any of the following defects shall be removed from service:

(a) Abnormal wear;

(b) Powdered fiber between strands;

(c) Sufficient cut or broken fibers to affect the capacity of the rope;

(d) Variations in the size or roundness of strands;

(e) Discolorations other than stains not associated with rope damage;

(f) Rotting; or

(g) Distortion or other damage to attached hardware.

(7) Thimbles. Properly fitting thimbles shall be used where any rope is secured permanently to a ring, shackle or attachment, where practical.

(8) Synthetic web slings.

(a) Slings and nets or other combinations of more than one piece of synthetic webbing assembled and used as a single unit (synthetic web slings) shall not be used to hoist loads in excess of the sling's rated capacity.

(b) Synthetic web slings shall be removed from service if they exhibit any of the following defects:

(i) Acid or caustic burns;

(ii) Melting or charring of any part of the sling surface;

(iii) Snags, punctures, tears or cuts;

(iv) Broken or worn stitches; or

(v) Distortion or damage to fittings.

(c) Defective synthetic web slings removed from service shall not be returned to service unless repaired by a sling manufacturer or similar entity. Each repaired sling shall be proof tested by the repairer to twice the slings' rated capacity prior to its return to service. The employer shall retain a certificate of the proof test and make it available for examination.

(d) Synthetic web slings provided by the employer shall only be used in accordance with the manufacturer's recommendations, which shall be made available upon request.

(e) Fittings shall have a breaking strength at least equal to that of the sling to which they are attached and shall be free of sharp edges.

(9) Chains and chain slings used for hoisting.

(a) The employer shall adhere to the manufacturer's recommended ratings for safe working loads for the sizes of the wrought iron and alloy steel chains and chain slings used and shall have such ratings available. When the manufacturer is unable to provide such ratings, the employer shall use the tables for chains and chain slings found in American National Safety Standard for Slings, ANSI B30.9-1971.

(b) Proof coil steel chain, also known as common or hardware chain, and other chain not recommended by the manufacturer for slinging or hoisting shall not be used for slinging or hoisting.

(c)(i) Sling chains, including end fastenings, shall be inspected for visible defects before each day's use and as often as necessary during use to ensure integrity of the sling.

(ii) Thorough inspections of chains in use shall be made quarterly to detect wear, defective welds, deformation, increase in length or stretch. The month of inspection shall be indicated on each chain by color of paint on a link or by other effective means.

(iii) Chains shall be removed from service when maximum allowable wear, as indicated in Table C-2, is reached at any point of link.

(iv) Chain slings shall be removed from service when stretch has increased the length of a measured section by more than five percent; when a link is bent, twisted or otherwise damaged; or when a link has a raised scarf or defective weld.

(v) Only designated persons shall inspect chains used for slinging and hoisting.

TABLE C-1  
NUMBER AND SPACING OF U-BOLT WIRE ROPE CLIPS

Improved Plow Steel, Rope Diameter Inches (cm)	Minimum Number of Clips		Minimum Spacing Inches (cm)
	Drop Forged	Other Material	
1/2 or less (1.3)	3	4	3 (7.6)
5/8 (1.6)	3	4	3 3/4 (9.5)
3/4 (1.9)	4	5	4 1/2 (11.4)
7/8 (2.2)	4	5	5 1/4 (13.3)
1 (2.5)	5	7	6 (15.2)
1 1/8 (2.7)	6	7	6 3/4 (17.1)
1 1/4 (3.2)	6	8	7 1/2 (18.1)
1 3/8 (3.5)	7	8	8 1/4 (21.0)
1 1/2 (3.8)	7	9	9 (22.9)

(f) Wire rope shall not be secured by knots.

(g) Eyes in wire rope bridles, slings, bull wires, or in single parts used for hoisting shall not be formed by wire rope clips or knots.

(h) Eye splices in wire ropes shall have at least three tucks with a whole strand of the rope and two tucks with one-half of the wire cut from each strand. Other forms of splices or connections which are demonstrated to be equally safe may be used.

(i) Except for eye splices in the ends of wires and for endless rope slings, each wire rope used in hoisting or lowering, or in bulling cargo, shall consist of one continuous piece without knot or splice.

(4) Natural fiber rope.

(a) The employer shall ascertain the manufacturer's ratings for the specific natural fiber rope used and have such ratings available at the terminal. The manufacturer's ratings shall be adhered to and a minimum design safety factor of five maintained.

(b) Eye splices shall consist of at least three full tucks. Short splices shall consist of at least six full tucks, three on each side of the center line.

(5) Synthetic rope.

(a) The employer shall adhere to the manufacturer's ratings and use recommendations for the specific synthetic fiber rope used and shall have such ratings available at the terminal.

(b) Unless otherwise recommended by the manufacturer, when synthetic fiber ropes are substituted for manila ropes of less than three inches (7.62 cm) circumference, the substitute shall be of equal size.

**TABLE C-2  
MAXIMUM ALLOWABLE WEAR AT ANY POINT OF LINK**

CHAIN SIZE		MAXIMUM ALLOWABLE WEAR	
Inches	(cm)	Inches	(cm)
1/4 (9/32)	(0.6)	3/64	(0.1)
3/8	(1.0)	5/64	(0.2)
1/2	(1.3)	7/64	(0.3)
5/8	(1.6)	9/64	(0.4)
3/4	(1.9)	5/32	(0.4)
7/8	(2.2)	1 1/64	(0.4)
1	(2.5)	3/16	(0.5)
1 1/8	(2.9)	7/32	(0.6)
1 1/4	(3.2)	1/4	(0.6)
1 3/8	(3.5)	3/32	(0.7)
1 1/2	(3.8)	5/16	(0.8)
1 3/4	(4.4)	1 1/32	(0.9)

(d) Chains shall only be repaired under qualified supervision. Links or portions of chain defective under any of the criteria of WAC 296-56-60073 (9)(c) shall be replaced with properly dimensioned links or connections of material similar to that of the original chain. Before repaired chains are returned to service, they shall be tested to the proof test load recommended by the manufacturer for the original chain. Tests shall be performed by the manufacturer or shall be certified by an agency accredited for the purpose under WAC 296-56-60093. Test certificates shall be available at the terminal.

(e) Wrought iron chains in constant use shall be annealed or normalized at intervals not exceeding six months. Heat treatment certificates shall be available at the terminal. Alloy chains shall not be annealed.

(f) Kinked or knotted chains shall not be used for lifting. Chains shall not be shortened by bolting, wiring or knotting. Makeshift links or fasteners such as wire, bolts or rods shall not be used.

(g) Hooks, rings, links and attachments affixed to sling chains shall have rated capacities at least equal to that of the chains to which they are attached.

(h) Chain slings shall bear identification of size, grade and rated capacity.

(10) Shackles.

(a) If available, the manufacturer's recommended safe working loads for shackles shall not be exceeded. In the absence of manufacturer's recommendations, Table C-3 shall apply.

(b) Screw pin shackles used aloft in house fall or other gear, except in cargo hook assemblies, shall have their pins moused or otherwise effectively secured.

**TABLE C-3  
SAFE WORKING LOADS FOR SHACKLES**

MATERIAL SIZE		PIN DIAMETER		SAFE WORKING LOAD IN 2,000 LB TONS
Inches	(cm)	Inches	(cm)	
1/4	(1.3)	5/8	(1.6)	1.4
5/8	(1.6)	3/4	(1.9)	2.2
3/4	(1.9)	7/8	(2.2)	3.2
7/8	(2.2)	1	(2.5)	4.3
1	(2.5)	1 1/8	(2.9)	5.6
1 1/8	(2.9)	1 1/4	(3.2)	6.7
1 1/4	(3.2)	1 3/8	(3.5)	8.2
1 3/8	(3.5)	1 1/2	(3.8)	10.0
1 1/2	(3.8)	1 5/8	(4.1)	11.9
1 3/4	(4.4)	2	(5.0)	16.2
2	(5.0)	2 1/4	(5.7)	21.2

(c) Tables G-2 through G-5 shall be used to determine the safe working loads of various sizes and classifications of improved plow steel wire rope slings with various types of terminals. For sizes, classifications and grades not included in these tables the safe working load recommended by the manufacturer for specific, identifiable products shall be followed, however, a safety factor of not less than five shall be maintained.

**TABLE G-1  
MANTLA ROPE  
(In pounds or tons of 2000 pounds)**

Circumferences	Diameter in inches	Single Leg			
		60 Degree	45 Degree	30 Degree	
3/4	1/4	120	204	170	120
1	5/16	200	346	282	200
1 1/8	3/8	270	467	380	270
1 1/4	7/16	350	605	493	350
1 3/8	1/2	450	775	635	450
1 1/2	5/8	530	915	798	530
1 3/4	3/4	690	1190	973	690
2	7/8	880	1520	1240	880
2 1/4	1	1080	1870	1520	1080
2 1/2	1 1/16	1300	2250	1830	1300
2 3/4	1 1/8	1540	2660	2170	1540
3	1 1/4	1800	3120	2540	1800
3 1/4	1 1/2	2100	3630	2960	2100
3 1/2	1 3/4	2400	4200	3420	2400
3 3/4	1 7/8	2700	4830	3930	2700
4	2	3000	5520	4480	3000
4 1/2	2 1/4	3400	6270	5170	3400
5	2 1/2	3900	7080	5900	3900
5 1/2	2 3/4	4400	7950	6670	4400
6	3	4900	8880	7480	4900
6 1/2	3 1/4	5400	9870	8330	5400

In making such a substitution it should be ascertained that the inherent characteristics of the synthetic fiber are suitable for the intended service of the rope.

**TABLE G-2 RATED CAPACITIES FOR IMPROVED PLOW STEEL, INDEPENDENT WIRE ROPE CORE, WIRE ROPE AND WIRE SLEINGS (IN TONS OF 2,000 POUNDS)**

Rope Diameter Inches	Single Leg					
	Vertical			Choker		
	A	B	C	A	B	C
<b>6 x 19 Classification</b>						
1/4"	3.9	3.6	3.3	4.4	4.2	4.0
3/8"	1.3	1.2	1.1	1.6	1.5	1.4
1/2"	2.3	2.2	2.0	2.7	2.6	2.4
5/8"	3.6	3.4	3.0	4.1	3.9	3.6
3/4"	5.1	4.9	4.3	5.3	5.1	4.7
7/8"	6.9	6.6	5.8	7.2	6.9	6.4
1"	9.0	8.5	7.5	9.4	8.9	8.2
1-1/8"	11	10	9.0	12	11	10
<b>6 x 37 Classification</b>						
1-1/4"	13	12	10	14	13	12
1-3/8"	16	15	13	17	16	15
1-1/2"	19	17	15	21	19	17
1-3/4"	26	24	20	28	26	24
2"	33	30	25	36	33	30
2-1/4"	41	38	31	44	41	38

(A) -- Socket or Swaged Terminal attachment.  
(B) -- Mechanical Sleeve attachment.  
(C) -- Hand Tucked Splice attachment.

**TABLE G-3 RATED CAPACITIES FOR IMPROVED PLOW STEEL, INDEPENDENT WIRE ROPE CORE, WIRE ROPE SLEINGS (IN TONS OF 2,000 POUNDS)**

Rope dia. inches	Two-leg bridle or basket hitch											
	Vertical			60 degree			45 degree			30 degree		
	A	B	C	A	B	C	A	B	C	A	B	C
<b>6 x 19 Classification</b>												
1/4"	1.2	1.1	1.0	1.0	.97	.93	.83	.79	.78	.79	.76	.73
3/8"	3.6	3.5	3.3	3.3	3.1	2.9	2.6	2.5	2.5	2.4	2.3	2.2
1/2"	6.6	6.4	5.9	6.0	5.8	5.4	4.8	4.6	4.6	4.4	4.3	4.1
5/8"	7.2	6.8	6.0	6.2	5.9	5.4	4.8	4.6	4.6	4.4	4.3	4.1
3/4"	10	9.7	8.4	8.9	8.4	7.5	7.2	6.9	6.9	6.7	6.5	6.2
7/8"	14	13	11	11	11	9.6	9.3	9.0	8.9	8.7	8.5	8.2
1"	18	17	14	15	14	12	11	10	10	9.8	9.5	9.2
1-1/8"	23	21	18	19	18	16	15	14	14	13	12	11
<b>6 x 37 Classification</b>												
1-1/4"	26	24	21	23	21	18	17	15	15	14	13	12
1-3/8"	32	29	25	28	25	22	21	18	18	17	16	15
1-1/2"	38	35	30	33	30	26	25	21	21	19	18	17
1-3/4"	51	47	41	44	41	35	34	29	29	27	26	24
2"	66	61	53	57	53	46	44	37	37	35	33	30
2-1/4"	83	76	66	72	66	57	58	47	47	44	41	38

(A) -- Socket or Swaged Terminal Attachment.  
(B) -- Mechanical Sleeve Attachment.  
(C) -- Hand Tucked Splice Attachment.

**TABLE G-4 RATED CAPACITIES FOR IMPROVED FLOW STEEL FIBER CORE WIRE ROPE AND WIRE ROPE SLINGS**  
(In Tons of 2,000 pounds)

Rope dia. Inches	Single leg					
	Vertical			Choker		
	A	B	C	A	B	C
6 x 19 Classification						
1/4	.55	.51	.49	.41	.38	.37
3/8	1.2	1.1	1.1	.91	.85	.80
1/2	2.1	2.0	1.8	1.6	1.5	1.4
5/8	3.3	3.1	2.8	2.5	2.3	2.1
3/4	4.8	4.4	3.9	3.6	3.3	2.9
7/8	6.4	5.9	5.1	4.8	4.5	3.9
1	8.4	7.7	6.7	6.3	5.8	5.0
1-1/8	10	9.5	8.4	7.9	7.1	6.3
6 x 37 Classification						
1-1/4	12	11	9.8	9.2	8.3	7.4
1-3/8	15	13	12	11	10	8.9
1-1/2	17	16	14	13	12	10
1-3/4	24	21	19	18	16	14
2	31	28	25	23	21	18





(A) - Socket or Swaged Terminal attachment.  
(B) - Mechanical Sleeve attachment.  
(C) - Hand Tucked Splice attachment.

**TABLE G-5 RATED CAPACITIES FOR IMPROVED FLOW STEEL FIBER CORE WIRE ROPE SLINGS**  
(In Tons of 2,000 Pounds)

Rope dia. Inches	Two-leg bridle or basket hitch											
	Vertical			60 Degree			45 Degree			30 Degree		
	A	B	C	A	B	C	A	B	C	A	B	C
6 x 19 Classification												
1/4	1.1	1.0	.99	.95	.88	.85	.77	.72	.70	.55	.51	.49
3/8	2.4	2.2	2.1	2.1	1.9	1.8	1.7	1.6	1.5	1.2	1.1	1.1
1/2	4.3	3.9	3.7	3.7	3.4	3.2	3.0	2.8	2.6	2.1	2.0	1.8
5/8	6.7	6.1	5.6	5.8	5.3	4.8	4.7	4.4	4.0	3.3	3.1	2.8
3/4	9.5	8.8	7.8	8.2	7.6	6.8	6.7	6.3	5.5	4.8	4.4	3.9
7/8	13	12	10	11	10	8.9	9.1	8.4	7.3	6.4	5.9	5.1
1	17	15	13	14	13	11	12	11	9.4	8.4	7.7	6.7
1-1/2	21	19	17	18	16	14	15	13	12	10	9.5	8.4
6 x 37 Classification												
1-1/4	25	22	20	21	19	17	17	16	14	12	11	9.8
1-3/8	30	27	24	26	23	20	21	19	17	15	13	12
1-1/2	35	32	28	30	27	24	25	22	20	17	16	14
1-3/4	48	43	38	41	37	33	34	30	27	24	21	19
2	62	55	49	53	48	43	43	39	35	31	28	25

(A) - Socket or Swaged Terminal attachment.  
(B) - Mechanical Sleeve attachment.  
(C) - Hand Tucked Splice attachment.

**TABLE G-6 ALLOY STEEL CHAIN**  
(In Tons of 2,000 Pounds)

Nominal size chain stock Inch.	Single leg	60 degree	45 degree	30 degree
				
1/4	1.62	2.82	2.27	1.62
3/8	3.30	5.70	4.65	3.30
1/2	5.62	9.75	7.90	5.62
5/8	8.25	14.25	11.65	8.25
3/4	11.5	19.9	16.2	11.5
7/8	14.3	24.9	20.3	14.3
1	19.3	33.5	27.3	19.8
1-1/8	22.2	38.5	31.5	22.2
1-1/4	28.7	49.7	40.5	28.7
1-3/8	33.5	58.0	47.0	33.5
1-1/2	39.7	68.5	56.0	39.7
1-5/8	42.5	73.5	59.5	42.5
1-3/4	47.0	81.5	62.0	47.0

(11) Hooks other than hand hooks.

(a) The manufacturer's recommendations shall be followed in determining the safe working loads of the various sizes and types of specific and identifiable hooks. All hooks for which no applicable manufacturer's recommendations are available shall be tested to twice the intended safe working load before they are initially put into use. The employer shall maintain a record of the dates and results of such tests.

(b) Loads shall be applied to the throat of the hook since loading the point may overstress, bend, or spring the hook.

(c) Hooks shall be inspected once a month to see that they have not been bent by overloading. Bent or sprung hooks shall not be used.

(d) Crane hooks. Magnetic particle or other suitable crack detecting inspection shall be performed at least once each year. When testing by x-ray, the pertinent provisions of the Nuclear Regulatory Commission's standards for protection against radiation, relating to protection against occupational radiation exposure, shall apply.

(e) Any activity which involves the use of radioactive materials or x-rays, whether or not under license from the Nuclear Regulatory Commission, shall be performed by competent persons specially trained in the proper and safe operation of such equipment. In the case

of materials used under commission license, only persons actually licensed, or competent persons under direction and supervision of the licensee, shall perform such work.

(f) Teeth of case hooks shall not be split, cracked, or deformed.

(g) Jaws of patent clamp type plate hooks shall be kept in safe condition so that they will grip plates securely.

(12) Pallets.

(a) Pallets shall be made and maintained to safely support and carry loads being handled. Fastenings of reusable pallets used for hoisting shall be bolts and nuts, drive screws (helically threaded nails), annular threaded nails or fastenings of equivalent holding strength.

(b) Damaged pallets shall be stored in designated areas and identified.

(c) Reusable wing or lip-type pallets shall be hoisted by bar bridles or other suitable gear and shall have an overhanging wing or lip of at least three inches (76.2 mm). They shall not be hoisted by wire slings alone.

(d) Loaded pallets that do not meet the requirements of this paragraph shall be hoisted only after being placed on pallets meeting such requirements or shall be handled by other means providing equivalent protection.

(e) Bridles for handling flush end or box-type pallets shall be designed to prevent disengagement from the pallet under load.

(f) Pallets shall be stacked or placed to prevent falling, collapsing or otherwise causing a hazard under standard operating conditions.

(g) Disposable pallets intended only for one use shall not be re-used for hoisting.

AMENDATORY SECTION (Amending Order 86-02, filed 1/17/86)

WAC 296-56-60079 GENERAL RULES APPLICABLE TO VEHICLES. (1) The requirements of this section apply to general vehicle use within marine terminals except in cases where the provisions of subsections (3) and (13) of this section are preempted by regulations of the department of transportation.

(2) Private vehicle parking in marine terminals shall be allowed only in designated areas.

(3) Trailers shall not be disconnected from tractors at loading docks until the road wheels have been immobilized. The road wheels shall be immobilized from the time the brake system is disconnected until braking is again provided. Supplementary front end support shall be employed as necessary to prevent tipping when a trailer is entered by a material handling vehicle. Rear end support shall be employed if rear wheels are so far forward as to allow tipping when the trailer is entered.

(4) The employer shall direct motor vehicle operators to comply with any posted speed limits, other traffic control signs or signals, and written traffic instructions.

(5) Stop signs shall be posted at main entrances and exits of structures where visibility is impaired, and at blind intersections, unless direct traffic control, warning mirror systems or other systems of equivalent safety are provided.

(6) Vehicular routes, traffic rules and parking areas shall be established, identified and used.

(7) Vehicle drivers shall warn anyone in traffic lanes of the vehicle's approach.

(8) Signs indicating pedestrian traffic shall be clearly posted at vehicular check-in and check-out lines and similar locations where employees may be working.

(9) A distance of not less than twenty feet (4.5 m) shall be maintained between the first two vehicles in a check-in or check-out line, or vessel loading or discharging line. This distance shall be maintained between any vehicles behind which employees work.

(10) No unattended vehicle shall be left with its engine running unless secured against movement (see WAC 296-56-60077 for powered industrial trucks).

(11) When the rear of a vehicle is elevated to facilitate loading or discharging, a ramp shall be provided and secured. The vehicle shall be secured against accidental movement during loading or discharging.

(12) Only vehicle floors in safe condition shall be used.

(13) When flatbed trucks, platform containers or similar conveyances are loaded or discharged and the cargo consists of pipe or other products which could spread or roll to endanger employees, the cargo shall be contained to prevent movement.

(14) Vehicles used to transport employees within a terminal shall be maintained in safe working order and safety devices shall not be removed or made inoperable.

## AMENDATORY SECTION (Amending Order 86-02, filed 1/17/86)

## WAC 296-56-60083 CRANES AND DERRICKS. (1) Scope.

(a) This section applies to every kind of crane and derrick and to any other type of equipment performing the functions of a crane or derrick except as noted in (b) of this subsection.

(b) This section does not apply to small industrial truck-type cranes, container handling toploaders and sideloaders, chain hoists, and mobile straddle-type cranes incapable of straddling two or more intermodal containers (sixteen feet (4.88 m) in width).

## (2) Ratings.

(a) Except for bridge cranes covered by subsection (7) of this section, cranes and derricks having ratings that vary with boom length, radius (outreach) or other variables shall have a durable rating chart visible to the operator, covering the complete range of the manufacturer's (or design) capacity ratings. The rating chart shall include all operating radii (outreach) for all permissible boom lengths and jib lengths as applicable, with and without outriggers, and alternate ratings for optional equipment affecting such ratings. Precautions or warnings specified by the owner or manufacturer shall be included.

(b) The manufacturer's (or design) rated loads for the conditions of use shall not be exceeded.

(c) Designated working loads shall not be increased beyond the manufacturer's ratings or original design limitations unless such increase receives the manufacturer's approval. When the manufacturer's services are not available or where the equipment is of foreign manufacture, engineering design analysis shall be performed or approved by a person accredited for certifying the equipment under WAC 296-56-60093. Cranes shall conform with the manufacturer's specifications or any current ANSI standards that apply. Engineering design analysis shall be performed by a registered professional engineer competent in the field of cranes and derricks. Any structural changes necessitated by the change in rating shall be carried out.

(3) Radius indicator. When the rated load varies with the boom radius, the crane or derrick shall be fitted with a boom angle or radius indicator visible to the operator.

## (4) Prohibited usage.

(a) Equipment shall not be used in a manner that exerts sideloading stresses upon the crane or derrick boom.

(b) No crane or derrick having a visible or known defect that affects safe operation shall be used.

## (5) Protective devices.

(a) When exposed moving parts such as gears, chains and chain sprockets present a hazard to employees during crane and derrick operations, those parts shall be securely guarded.

(b) Crane hooks shall be latched or otherwise secured to prevent accidental load disengagement.

(c) When hoisting personnel in an approved man basket, the hook shall have a positive safety latch to prevent rollouts.

## (6) General.

## (a) Operating controls.

(i) Crane and derrick operating controls shall be clearly marked, or a chart indicating their function shall be posted at the operator's position.

(ii) All crane controls shall operate in a uniform manner within a given port.

(iii) Overhead bridge and container gantry crane operating control levers shall be self-centering so that they will automatically move to the "off" position when the operator releases the control.

(b) Booms. Cranes with elevatable booms and without operable automatic limiting devices shall be provided with boom stops if boom elevation can exceed maximum design angles from the horizontal.

(c) Foot pedals. Foot pedals shall have a nonskid surface.

(d) Access. Ladders, stairways, stanchions, grab irons, foot steps or equivalent means shall be provided as necessary to ensure safe access to footwalks, cab platforms, the cab and any portion of the superstructure which employees must reach.

(i) Footwalks shall be of rigid construction, and shall be capable of supporting a load of one hundred pounds (4.79 kPa) per square foot.

(ii) If more than twenty feet (6.1 m) in height, vertical ladders shall comply with WAC 296-56-60209 (4), (5)(a), (5)(b)(iii) and (5)(b)(iv).

(iii) Stairways on cranes shall be equipped with rigid handrails meeting the requirements of WAC 296-56-60123 (5)(a).

(iv) If the top of a ladder or stairway or any position thereof is located where a moving part of a crane, such as a revolving house, could strike an employee ascending or descending the ladder or stairway, a

prominent warning sign shall be posted at the foot of the ladder or stairway. A system of communication (such as a buzzer or bell) shall be established and maintained between the foot of the ladder or stairway and the operator's cab.

(e) Operator's station. The cab, controls, and mechanism of the equipment shall be so arranged that the operator has a clear view of the load or signalman, when one is used. Cab glass, when used, shall be safety plate glass or equivalent and good visibility shall be maintained through the glass. Clothing, tools and equipment shall be stored so as not to interfere with access, operation, or the operator's view.

(f) Counterweights or ballast. Cranes shall be operated only with the specified type and amount of ballast or counterweights. Ballast or counterweight shall be located and secured only as provided in the manufacturer's or design specifications, which shall be ((made)) available ((upon request)).

(g) Outriggers. Outriggers shall be used according to the manufacturer's specifications or design data, which shall be ((made)) available ((upon request)). Floats, when used, shall be securely attached to the outriggers. Wood blocks or other support shall be of sufficient size to support the outrigger, free of defects that may affect safety and of sufficient width and length to prevent the crane from shifting or toppling under load.

(h) Exhaust gases. Engine exhaust gases shall be discharged away from the normal position of crane operating personnel.

(i) Electrical equipment shall be so located or enclosed that live parts will not be exposed to accidental contact. Designated persons may work on energized equipment only if necessary during inspection, maintenance, or repair.

## (j) Fire extinguisher.

(i) At least one portable fire extinguisher of at least 5-BC rating or equivalent shall be accessible in the cab of the crane or derrick.

(ii) No portable fire extinguisher using carbon tetrachloride or chlorobromomethane extinguishing agents shall be used.

(k) Rope on drums. At least three full turns of rope shall remain on ungrooved drums, and two turns on grooved drums, under all operating conditions. Wire rope shall be secured to drums by clamps, U-bolts, shackles, or equivalent means. Fiber rope fastenings are prohibited.

(l) Assembly or disassembly of boom sections. Mobile crane booms being assembled or disassembled on the ground with or without the support of the boom harness shall be blocked to prevent dropping of the boom or boom sections.

## (m) Brakes.

(i) Each independent hoisting unit of a crane shall be equipped with at least one holding brake, applied directly to the motor shaft or gear train.

(ii) Each independent hoisting unit of a crane, except worm geared hoists, the angle of whose worm is such as to prevent the load from accelerating in the lowering direction, shall, in addition to a holding brake, be equipped with a controlled braking means to control lowering speeds.

(iii) Holding brakes for hoist units shall have not less than the following percentage of the rated load hoisting torque at the point where the brake is applied:

(A) One hundred twenty-five percent when used with a controlled braking means.

(B) One hundred percent when used with a mechanically-controlled braking means.

(C) One hundred percent when two holding brakes are provided.

(iv) All power control braking means shall be capable of maintaining safe lowering speeds of rated loads.

(n) Each crane or derrick shall be equipped with sufficient lights to maintain five foot candles in the working area around the load hook. All crane ladders and machinery houses shall be illuminated at a minimum of two candle power.

(o) Light fixtures connected to the boom, gantry legs, or machinery house shall be provided with safety devices which will prevent the light fixture from falling in case of bracket failure.

(p) Electronic devices may be installed to prevent collision subject to approval of the accredited certification agency.

(q) On all rail gantry cranes, truck guards shall extend on the ends of the trucks, close to the top of the rail to prevent worker's feet from being caught between the rail and wheel. This subsection does not apply if rail sweeps are present.

(r) All hydraulic cylinders used to control crane booms or to provide crane stability (outriggers) shall be equipped with a pilot operated check valve or a device which will prevent the boom or outrigger from retracting in case of failure of a component of the hydraulic system.

(s) Gantry cranes shall be provided with automatic rail clamps or other devices to prevent the crane from moving when not being used or when power is off.

(7) Rail-mounted cranes (excluding locomotive types).

(a) For the purposes of this section, rail-mounted cranes include bridge cranes and portal cranes.

(b) Rated load marking. The rated loads of bridge cranes shall be plainly marked on each side of the crane and in the cab. If there is more than one hoisting unit, each hoist shall have its rated load marked on it or on its load block. Marking shall be legible from the ground level.

(c) Wind-indicating devices.

(i) Each rail-mounted bridge and portal crane located outside of an enclosed structure shall be fitted with an operable wind-indicating device.

(ii) The wind indicating device shall provide a visible or audible warning to alert the operator of high wind conditions. That warning shall be transmitted whenever the following circumstances are present:

(A) When wind velocity reaches the warning speed, not exceeding the crane manufacturer's recommendations; and

(B) When wind velocity reaches the shutdown speed, not exceeding the crane manufacturer's recommendations, at which work is to be stopped and the crane secured.

(iii) Instructions. The employer shall post operating instructions for high wind conditions in the operator's cab of each crane. Operators shall be directed to comply with these instructions. The instructions shall include procedures for responding to high wind alerts and for any coordination necessary with other cranes.

(d) Securing of cranes in high winds.

(i) When the wind reaches the crane's warning speed:

(A) Gantry travel shall be stopped; and

(B) The crane shall be readied for shutdown.

(ii) When the wind reaches the crane's shutdown speed:

(A) Any portion of the crane spanning or partially spanning a vessel shall be moved clear of the vessel if safe to do so; and

(B) The crane shall be secured against travel, using all available means of securing.

(e) The employer shall monitor local weather conditions by subscribing to a weather service or using equally effective means.

(f) Stops and bumpers.

(i) The ends of all tracks shall be equipped with stops or bumpers. If a stop engages the tread of the wheel, it shall be of a height not less than the radius of the wheel.

(ii) When more than one crane operates on the same runway or more than one trolley on the same bridge, each crane or trolley shall be equipped with bumpers or equivalent devices at adjacent ends subject to impact.

(g) Employee exposure to crane movement. When employees may be in the vicinity of the tracks, crane trucks shall be equipped with personnel-deflecting guards.

(h) Pedestrian clearance. If the track area is used for employee passage or for work, a minimum clearance of three feet (0.9 m) shall be provided between trucks or the structures of rail-mounted cranes and any other structure or obstruction. When the required clearance is not available on at least one side of the crane's trucks, the area shall not be used and shall be marked and identified.

(i) Warning devices. Rail-mounted cranes shall be equipped with an effective (~~travel~~) audible and visible (~~(:)~~) ~~travel~~ warning device which shall be used to warn employees who may be in the path of the moving crane.

(j) Communications.

(i) Means of communication shall be provided between the operator's cab and the base of the gantry of all rail-mounted cranes. This requirement may be met by telephone, radio, sound-signaling system or other effective methods, but not solely by hand-signaling.

(ii) All rail-mounted cranes thirty ton and above capacity shall be equipped with a voice hailing device (PA system) from the operator to the ground, audible within one hundred feet.

(k) Cranes and crane operations—Scope and application. The sections of this chapter, WAC 296-56-60083 through 296-56-60099, apply to cranes and crane operations.

(l) Signalmen. A signalman shall be required when a crane operator's visibility is obstructed. When a signalman is required to transmit hand signals, he shall be in such a position that the operator can plainly see the signals.

(m) Signals. All operators and signalmen shall use standard signals as illustrated for longshore crane operations. (See Appendices C and D, at the end of this chapter.)

(n) Signalman for power units. Where power units, such as cranes and winches are utilized and signaling is required, the operator shall be instructed as to who is authorized to give signals. The operator shall take signals only from such authorized person. In case of emergency, any worker shall be authorized to give a stop signal.

(i) No draft shall be hoisted unless the winch or crane operator can clearly see the draft itself or see the signals of any signalman associated with the operation.

(ii) Loads requiring continuous manual guidance while in motion shall be provided with tag lines.

(o) Landing loads. Persons assisting in landing a load shall face the load and use caution to prevent themselves from getting in a position where they may be caught between the load and a fixed object.

(8) Stabilizing of locomotive cranes. Loads may be hoisted by locomotive cranes only if outriggers are in place, unless means are taken to prevent the load being carried by the truck springs of the crane.

(9) Operations.

(a) Use of cranes together. When two or more cranes hoist a load in unison, a designated person shall direct the operation and instruct personnel in positioning, rigging of the load and movements to be made.

(b) Guarding of swing radius. Accessible areas within the swing radius of the body of a revolving crane shall be physically guarded during operations to prevent an employee from being caught between the body of the crane and any fixed structure or between parts of the crane.

(c) Securing mobile crane components in transit. The crane's superstructure and boom shall be secured against rotation and carried in line with the direction of travel except when negotiating turns with an operator in the cab or when the boom is supported on a dolly. The empty hook or other attachment shall be secured.

(d) Unattended cranes. The following steps shall be taken before leaving a crane unattended between work periods:

(i) Suspended loads, such as those hoisted by lifting magnets or clamshell buckets, shall be landed unless the storage position or maximum hoisting of the suspended device will provide equivalent safety;

(ii) Clutches shall be disengaged;

(iii) The power supply shall be shut off;

(iv) The crane shall be secured against accidental travel; and

(v) The boom shall be lowered or secured against movement.

(e) Operating near electric power lines.

(i) Clearance. Unless electrical distribution and transmission lines are deenergized and visibly grounded at point of work, or unless insulating barriers not a part of or an attachment to the crane have been erected to prevent physical contact with lines, cranes may be operated near power lines only in accordance with following:

(A) For lines rated 50 kV or below, minimum clearance between the lines and any part of the crane or load shall be ten feet (3 m);

(B) For lines rated over 50 kV, minimum clearance between the lines and any part of the crane or load shall be either 10 feet (3 m) plus 0.4 inch (10 mm) for each 1 kV over 50 kV, or twice the length of the line insulator, but never less than ten feet; and

(C) In transit with no load and boom lowered, the clearance shall be a minimum of four feet (1.2 m).

(ii) Boom guards. Cage-type boom guards, insulating links or proximity warning devices may be used on cranes, but they shall not be used in place of the clearances required by subsection (9)(e)(i) of this section.

(iii) Determination of energized lines. Any overhead line shall be presumed to be energized until the owner of the line indicates that it is not energized.

(10) Protection for employees being hoisted.

(a) No employee shall be hoisted by the load hoisting apparatus of a crane or derrick except:

(i) On intermodal container spreaders, equipped in accordance with this subsection; or

(ii) In a boatswain's chair or other device rigged to prevent it from accidental disengagement from the hook or supporting member; or

(iii) On a platform meeting the following requirements:

(A) Enclosed by a railing or other means providing protection equivalent to that described in WAC 296-56-60123(3). If equipped with open railings, the platform shall be fitted with toe boards;

(B) Having a safety factor of four based on ultimate strength;



(C) Bearing a plate or permanent marking indicating maximum load rating, which shall not be exceeded, and the weight of the platform itself;

(D) Equipped with a device to prevent access doors, when used, from opening accidentally;

(E) Equipped with overhead protection for employees on the platform if they are exposed to falling objects or overhead hazards;

(F) Secured to the load line by means other than wedge and socket attachments, unless the free (bitter) end of the line is secured back to itself by a clamp placed as close above the wedge as possible.

(b) Except in an emergency, the hoisting mechanism of all overhead and container gantry cranes used to hoist personnel shall operate in power up and power down, with automatic brake application when not hoisting or lowering.

(c) Variable radius booms of a crane or derrick used to hoist personnel shall be so constructed or secured as to prevent accidental boom movement.

(d) Platforms or devices used to hoist employees shall be inspected for defects before each day's use and shall be removed from service if defective.

(e) Employees being hoisted shall remain in continuous sight of and communication with the operator or signalman.

(f) Operators shall remain at the controls when employees are hoisted.

(g) Cranes shall not travel while employees are hoisted, except in emergency or in normal tier to tier transfer of employees during container operations.

(h) When intermodal container spreaders are used to transfer employees to or from the tops of containers, the spreaders shall be equipped with a personnel platform equipped with fixed railings, provided that the railings have one or more openings for access. The openings shall be fitted with a means of closure, such as chains with hooks. Existing railings shall be at least thirty-six inches (0.91 m) in height. New railings installed after October 3, 1983 shall be forty-two inches (1.07 m), plus or minus three inches (7.6 cm), in height. The provisions of (a)(iii)(C), (D), and (F) of this subsection also apply to personnel platforms when container spreaders are used.

(i) Positive safety latch-type hooks or moused hooks shall be used.

(1) Routine inspection.

(a) Designated persons shall visually inspect each crane and derrick on each day of use for defects in functional operating components and shall report any defect found to the employer. The employer shall inform the operator of the findings.

(b) A designated person shall thoroughly inspect all functional components and accessible structural features of each crane or device at monthly intervals.

(c) Any defects found during such inspections which may create a safety hazard shall be corrected before further use. Repairs shall be performed only by designated persons.

(d) A record of monthly inspections shall be maintained for six months in or on the crane or derrick or at the terminal.

#### AMENDATORY SECTION (Amending Order 86-02, filed 1/17/86)

##### WAC 296-56-60085 CRANE LOAD AND LIMIT DEVICES.

(1) Except as provided in subsection (8) of this section, every crane shall be fitted with a load indicating device or alternative device in proper working condition.

The type or model or any load indicating or alternate device which is used shall provide:

(a) A direct indication in the cab of actual weight hoisted or a means of determining this by referencing a weight indication to crane ratings posted and visible to the operator. The use of a dynamometer or simple scale alone shall not meet this requirement; or

(b) Indications in the cab according to the radius and load at the moment; or

(c) A direct means to prevent an overload from occurring.

(2) Accuracy of the devices required by this section shall be such that any indicated load (or limit), including the sum of actual weight hoisted and additional equipment or "add ons" such as slings, sensors, blocks, etc., is within the range from no less than ninety-five percent of the actual true total load (five percent overload) to one hundred ten percent of the actual true total load (ten percent underload). Such accuracy shall be required over the range of the daily operating variables to be expected under the conditions of use.

(3) The device shall permit the operator to determine, before making any lift, that the indicating or substitute system is operative. In the alternative, if a device is so mounted or attached to preclude such a

determination, it may not be used unless it has been certified by the manufacturer to remain operable within the limits stated in subsection (2) of this section for a specific period of use. Checks for accuracy, using known values of load, shall be performed at the time of every certification survey (see WAC 296-56-60093) and at such additional times as may be recommended by the manufacturer.

(4) When a load indicating device or alternative system is so arranged in the supporting system (crane structure) that its failure could cause the load to be dropped, its strength shall not be the limiting factor of the supporting system (crane structure).

(5) Marking shall be conspicuously placed giving: Units of measure in pounds or both pounds and kilograms, capacity of the indicating system, accuracy of the indicating system, and operating instructions and precautions. In the case of systems utilizing indications other than actual weights, the marking shall include data on: The means of measurement, capacity of the system, accuracy of the system, operating instructions and precautions. If the system used provides no read-out, but it is such as to automatically cease crane operation when the rated load limit under any specific condition of use is reached, marking shall be provided giving the make and model of the device installed, a description of what it does, how it is operated, and any necessary precautions regarding the system. All weight indications, other types of loading indications, and other data required shall be readily visible to the operator.

(6) All load indicating devices shall be operative over the full operating radius. Overall accuracy shall be based on actual applied load and not on full scale (full capacity) load.

Explanatory note. For example, if accuracy of the load indicating device is based on full scale load and the device is arbitrarily set at plus or minus ten percent, it would accept a reading between ninety thousand and one hundred ten thousand pounds, at full capacity of a machine with one hundred thousand pounds, maximum rating, but would also allow a reading between zero and twenty thousand pounds, at that outreach (radius) at which the rating would be ten thousand pounds capacity—an unacceptable figure. If, however, accuracy is based on actual applied load under the same conditions, the acceptable range would remain the same with the one hundred thousand pound load but becomes a figure between nine thousand and eleven thousand pounds, a much different and acceptable condition, at the ten thousand pound load.

(7) When the device uses the radius as a factor in its use or in its operating indications, the indicated radius (which may be in feet and/or meters, or degrees of boom angle, depending on the system used) shall be a figure which is within the range of a figure no greater than one hundred ten percent of the actual radius to a figure which is no less than ninety-seven percent of the actual (true) radius. A conversion chart shall be provided whenever it is necessary to convert between degrees of radius and feet or meters.

(8) The load indicating device requirements of this section do not apply to a crane:

(a) Of trolley equipped bridge type while handling container known to be and identified as empty, or loaded, and in either case in compliance with the provisions of WAC 296-56-60103, or while hoisting other lifts by means of a lifting beam supplied by the crane manufacturer for the purpose, and in all cases within the crane rating;

(b) While handling bulk commodities or cargoes by means of clamshell bucket or magnet;

(c) While used to handle or hold hoses in connection with transfer of bulk liquids or other hose handled products; or

(d) While the crane is used exclusively to handle cargo or equipment the total actual gross weight of which is known by means of marking of the unit or units hoisted, when such total actual gross weight never exceeds eleven thousand two hundred pounds, and when eleven thousand two hundred pounds, is less than the rated capacity of the crane at the maximum outreach that is possible under the conditions of use at the time.

(9) Limit switches shall be installed on the main line and whip line assemblies which will deactivate the hoisting power when a load reaches the upper limits of travel and at such other places as required by this chapter. Line limit switches shall be tested prior to or at the beginning of each shift to determine if they are functioning properly. Any malfunction shall be reported to the person in charge immediately and shall be repaired at the first reasonable opportunity.



**AMENDATORY SECTION** (Amending Order 86-02, filed 1/17/86)

WAC 296-56-60091 SPOUTS, CHUTES, HOPPERS, BINS, AND ASSOCIATED EQUIPMENT. (1) Standing and running rigging and associated gear used as a permanent part of spouts, chutes or similar devices shall be inspected before each use and shall not be used if it has any functional defects. (See WAC 296-56-60093 for certification requirements.)

(2) Direct communication shall be provided between the discharge or shipboard control end of loading spouts or chutes, and the point in the terminal from which the flow of cargo is controlled.

(3) Chute and hopper openings which present a hazard shall be guarded to prevent employees from falling through.

(4) When employees are working on hoppers, the hopper shall be equipped with a safe walkway and safe means of access.

(5) ~~(Whenever employees are exposed to the hazard of falling objects, chutes shall be equipped with sideboards.)~~ When necessary for the safety of employees, chutes shall be equipped with sideboards to afford protection from falling objects.

(6) Chutes shall be firmly placed and secured to prevent them from falling.

(7) When necessary for the safety of employees, provisions shall be made for braking objects other than bulk commodities at the delivery end of the chute.

(8) Before an employee enters an empty bin:

(a) Personnel controlling the flow of cargo into the bin shall be notified of the entry; and

(b) The power supply to the equipment carrying the cargo to the bin shall be turned off, locked out and tagged.

(9) Before an employee enters a bin containing a bulk commodity such as coal or sugar, the employer shall ensure that:

(a) Personnel controlling the flow of cargo into the bin shall be notified of the entry;

(b) The power supply to the equipment carrying the cargo to the bin shall be turned off, locked out and tagged;

(c) The employee entering the bin shall wear a life-line and safety harness; and

(d) A standby attendant equipped to perform a rescue shall be continuously stationed outside the bin until the employee has left the bin.

(10) Bin top openings that present a hazard to employees shall be covered to prevent employees from falling into bins.

(11) Chutes and hoppers shall be repaired only by designated persons.

(12)(a) Before power shoveling operations begin, a designated person shall inspect the equipment to be used. The inspection shall include at least the eye bolts, wires, and sheaves.

(b) Power shovels and associated equipment with defects affecting safe operation shall not be used.

(c) Before adjustments are made to a power shovel, wire, or associated equipment, the power supply to the shovel shall be turned off, locked out, and tagged, the belt stopped, and the hopper closed.

**AMENDATORY SECTION** (Amending Order 89-03, filed 5/15/89, effective 6/30/89)

WAC 296-56-60103 TERMINALS HANDLING INTERMODAL CONTAINERS OR ROLL-ON ROLL-OFF OPERATIONS. (1) Every intermodal container shall be legibly and permanently marked with:

(a) The weight of the container when empty, in pounds;

(b) The maximum cargo weight the container is designed to carry, in pounds; and

(c) The sum of the maximum weight of the container with cargo, in pounds (gross container capacity).

(2) No container shall be hoisted by any crane or derrick unless the following conditions have been met:

(a) The employer shall ascertain from the carrier whether a container to be hoisted is loaded or empty. Empty containers shall be identified before loading or discharge in such a manner as will inform every supervisor and foreman on the site and in charge of loading or discharging, and every crane or other hoisting equipment operator and signalman, if any, that the container is empty. Methods of identification may include cargo plans, manifests or markings on the container.

(b) In the case of a loaded container:

(i) The actual gross weight shall be plainly marked so as to be visible to the crane operator, other hoisting equipment operator, signalman, and to every supervisor and foreman on the site and in charge of the operation; or

(ii) The cargo stowage plan or equivalent permanently recorded display serving the same purpose, containing the actual gross weight and the serial number or other positive identification of that specific container, shall be provided to the crane or other hoisting equipment operator and signalman, if any, and to every supervisor and foreman on the site and in charge of the operation.

(c) Every outbound loaded container which is received at a marine terminal ready to load aboard a vessel without further consolidation or loading shall be weighed to obtain the actual gross weight before being hoisted.

(d)(i) When container weighing scales are located at a marine terminal, any outbound container with a load consolidated at that terminal shall be weighed to obtain an actual weight before being hoisted.

(ii) If the terminal has no scales, the actual gross weight may be calculated on the basis of the container's contents and the container's empty weight. The weights used in the calculation shall be posted conspicuously on the container, with the name of the person making the calculation and the date.

(iii) Container weights shall be subject to random sample weight checks at the nearest weighing facility. In cases where such weight checks or experience otherwise indicate consistently inaccurate weights, the weight of containers so calculated at the source from which the inaccurate weights originated shall no longer be recognized as true gross weights. Such containers shall not be hoisted unless actual gross weights have been obtained by weighing.

(e) The following containers are exempted from the requirements of (c) and (d) of this subsection:

(i) Open type vehicle containers.

(ii) Dry, or closed type containers, which are being used to transport vehicles and which contain no other cargo, and have the contents clearly marked on the outside.

(iii) Containers built specifically for the carriage of compressed gases.

(f) The weight of loaded inbound containers from foreign ports shall be determined by weighing or by the method of calculation described in (d)(ii) of this subsection or by shipping documents.

(g) Any scale used within Washington state to weigh containers for the purpose of the requirements of this section shall meet the accuracy standards of the state or local public authority in which the scale is located.

(3) No container shall be hoisted if its actual gross weight exceeds the weight marked as required in subsection (1)(c) of this section, or if it exceeds the capacity of the crane or other hoisting device intended to be used.

(4)(a) Marked or designated areas shall be set aside within a container or roll-on roll-off terminal for passage of employees to and from active cargo transfer points, except where transportation to and from those points is provided by the employer.

(b) The employer shall direct employees to stay clear of the area beneath a suspended container. Employees shall stay clear of the area beneath a suspended container.

(5) Employees working in the immediate area of container handling equipment or in the terminal's traffic lanes shall wear high visibility vests, decals, reflectors or equivalent protection.

(6) Containers shall be handled using lifting fittings or other arrangements suitable and intended for the purposes as set forth in (a) and (c) of this subsection, except when damage to an intermodal container makes special means of handling necessary.

(a) Loaded intermodal containers of twenty feet (6.1 m) or more in length shall be hoisted as follows:

(i) When hoisting by the top fittings, the lifting forces shall be applied vertically from at least four top fittings or by means which will safely lift the container without damage. The lifting fittings provided shall be used.

(ii) If hoisted from bottom fittings, the hoisting connections shall bear on the fittings only, making no other contact with the container. The angles of the four bridle legs shall not be less than thirty degrees to the horizontal in the case of forty foot (12.2 m) containers, thirty-seven degrees in the case of thirty foot (9.1 m) containers, or forty-five degrees in the case of twenty foot (6.1 m) containers.

(iii) Lifting containers by fork lift trucks or by grapples arms from above or from one side may be done only if the container is designed for this type of handling.

(b) Other means of hoisting (~~other than those required by subsection (2) of this section~~) may be used only if the containers and hoisting means are designed for such use.

(c)(i) When using intermodal container spreaders that employ lanyards for activation of load-disengagement, all possible precautions shall be taken to prevent accidental release of the load.

(ii) Intermodal container spreader twistlock systems shall be designed and used so that a suspended load cannot accidentally be released.

~~((77))~~ (d) Flat bed trucks or container chassis used to move intermodal containers shall be equipped with pins, flanges, or other means to prevent the container from shifting.

~~((88))~~ (7)(a) Intermodal containers shall be inspected for defects in structural members or fittings before handling.

(b) Any intermodal container found to be unsafe shall be identified as such, promptly removed from service and repaired before being returned to service.

~~((99))~~ (8) Containers shall not be hoisted unless all engaged chassis twist locks are released.

#### AMENDATORY SECTION (Amending Order 86-02, filed 1/17/86)

WAC 296-56-60107 TERMINAL FACILITIES HANDLING MENHADEN AND SIMILAR SPECIES OF FISH. (1)(a) Tanks in terminal areas used for receiving or storing brailwater for recirculating into vessel holds in discharging operations shall be opened or ventilated to minimize contamination of water circulated to the vessel. Brailwater tanks shall be thoroughly drained upon completion of each day's operations and shall be left open to the air. Drainage is unnecessary when brailwater has been treated to remove hydrogen sulfide-producing contaminants and the efficiency of such treatment has been established.

(b) Before employees enter a dock tank, it shall first be drained, rinsed and tested for hydrogen sulfide and oxygen deficiency. Employees shall not enter the tank when the hydrogen sulfide level exceeds twenty ppm or oxygen content is less than nineteen and one-half percent, except in emergencies (~~(see subsection (3) of this section)~~).

(c) Tests shall be conducted by designated personnel with suitable test equipment and respiratory protective equipment complying with the provisions of this chapter and chapter 296-62 WAC.

(2) Pipelines and hoses on the dock or terminal used for receiving and circulating used brailwater shall be completely drained upon completion of each day's operation and left open to the air.

(3) At least four units of respiratory protective equipment consisting of supplied-air respirators or self-contained breathing apparatus complying with the requirements of chapter 296-62 WAC shall be available in a suitably labeled cabinet for immediate use in case of an emergency caused by oxygen deficiency or hydrogen sulfide. Any employee entering a tank in an emergency shall, in addition to respiratory protective equipment, wear a lifeline and safety harness to facilitate rescue. At least two other employees, similarly equipped, shall be continuously stationed outside the tank to observe and to provide rescue services.

(4) The plant superintendent and foremen shall be trained and knowledgeable about the hazards of hydrogen sulfide and oxygen deficiency. They shall be trained in the use of appropriate respiratory and other protective equipment, and in rescue procedures. Other supervisory plant personnel shall be informed of these hazards and instructed in the necessary safety measures, including use of respiratory and rescue equipment.

(5) Supervisory personnel shall be on hand at dockside to supervise discharging of brailwater from vessels.

#### AMENDATORY SECTION (Amending Order 86-02, filed 1/17/86)

WAC 296-56-60109 EYE PROTECTION. (1)(a) When employees perform work hazardous to the eyes, the employer shall provide eye protection equipment marked or labeled as meeting the manufacturing specifications of American National Standards Practice for Occupational and Educational Eye and Face Protection, ANSI Z87.1-1968 (~~(The employer)~~), and shall direct that (~~(eye protection is)~~) it be used.

(b) For employees wearing corrective spectacles, eye protection equipment required by (a) of this subsection shall be of a type which can be worn over spectacles. Prescription ground safety lenses may be substituted if they provide equivalent protection.

(c) For additional requirements covering eye protection against radiant energy, see WAC 296-56-60235(8).

(2) Eye protection equipment shall be maintained in good condition.

(3) Used eye protection equipment shall be cleaned and disinfected before reissuance to another employee.

#### AMENDATORY SECTION (Amending Order 86-02, filed 1/17/86)

WAC 296-56-60115 OTHER PROTECTIVE MEASURES. (1) Protective clothing.

(a) Employees performing work that requires special protective clothing shall be directed by the employer to wear the necessary special protective clothing.

(b) When necessary, protective clothing previously worn shall be cleaned and disinfected before reissuance.

(2) Personal floatation devices.

(a) The employer shall provide, and shall direct the wearing of personal floatation devices for those employees, such as line handlers, who are engaged in work in which they may fall into the water:

(i) When such employees are working in isolation: or

(ii) Where physical limitations of available working space creates a hazard of falling into the water: or

(iii) Where the work area is obstructed by cargo or other obstacles so as to (~~(hinder)~~) prevent employees from obtaining safe footing for their work.

(b) Employees working on, over or along water, where the danger of drowning exists, shall be provided with and shall wear approved personal floatation devices.

(i) Employees are not considered exposed to the danger of drowning when:

(A) The water depth is known to be less than chest deep on the exposed individual;

(B) Working behind standard height and strength guardrails;

(C) Working inside operating cabs or stations which eliminate the possibility of accidental falling into the water;

(D) Wearing approved safety belts with lifeline attached so as to preclude the possibility of falling into the water.

(ii) Prior to and after each use, personal floatation devices shall be inspected for defects which would reduce their designed effectiveness. Defective personal floatation devices shall not be used.

(iii) To meet the requirement of (b) of this subsection, a personal floatation device shall be approved by the United States Coast Guard as a Type I PFD, Type II PFD, Type III PFD, or Type V PFD, or equivalent, pursuant to 46 CFR 160 (Coast Guard Lifesaving Equipment Specifications) and 33 CFR 175.23 (Coast Guard Table of Devices Equivalent to Personal Floatation Devices). Ski belt or inflatable type personal floatation devices are specifically prohibited.

(c) Life rings.

(i) Along docks, walkways or other fixed installations on or adjacent to open water more than five feet deep, approved life rings with line attached shall be provided. The life rings shall be spaced at intervals not to exceed two hundred feet and shall be kept in easily visible and readily accessible locations.

(ii) When employees are assigned work at other casual locations where exposure to drowning exists, at least one approved life ring with line attached shall be provided in the immediate vicinity of the work.

(iii) Work assigned over water where the vertical drop from an accidental fall exceeds fifty feet, is subject to specific procedures approved by the department.

(iv) Lines attached to life rings shall be at least ninety feet in length, at least one-quarter inch in diameter and have a minimum breaking strength of five hundred pounds.

(v) Life rings must be United States Coast Guard approved thirty inch size.

(vi) Life rings and attached lines must be maintained to retain at least seventy-five percent of their designed buoyancy and strength.

(3) Emergency facilities. When employees are exposed to hazardous substances which may require emergency bathing, eye washing or other facilities, the employer shall provide such facilities and maintain them in good working order.

#### AMENDATORY SECTION (Amending Order 86-02, filed 1/17/86)

WAC 296-56-60123 GUARDING OF EDGES. (1) Vehicle protection.

(a) Vehicle curbs, bull rails, or other effective barriers at least six inches (13.74 cm) in height and six inches in width, shall be provided at the waterside edges of aprons and bulkheads, except where vehicles are prohibited. Curbs or bull rails installed after January 1, 1985, shall be at least ten inches (22.9 cm) in height.

(b) The provisions of (a) of this subsection also apply at the edge of any fixed level above the common floor area from which vehicles may fall, except at loading docks, platforms and skids where cargo is moved by vehicles.

## (2) Employee protection.

(a) Guardrails shall be provided at locations where employees are exposed to falls of more than four feet from floor or wall openings or waterside edges, including bridges or gangway-like structures leading to pilings, vessel mooring or berthing installations.

## (b) Guardrails are not required:

- (i) At loading platforms and docks;
- (ii) At waterside edges used for cargo or mooring line handling;
- (iii) On the working sides of work platforms, skids, or similar work-places which abut the work area; or
- (iv) On railroad rolling stock, highway vehicles, intermodal containers, or similar equipment.

(c) Where guardrails are impractical due to machinery requirements or work processes, an alternate means of fall protection, such as nets, shall be used.

(3) Criteria for guardrails. Guardrails shall meet the following criteria:

(a) They shall be capable of withstanding a force of at least two hundred pounds (890 N) applied in any direction at mid-span of the top rail (when used), or at the uppermost point if there is no guard rail.

(b) If not of solid baluster, grillwork, slatted, or similar construction, guardrails shall consist of top rails and midrails. Midrails, when used, shall be positioned at approximately half the height of the top rail.

(c) The top surface of guardrails installed before October 3, 1983, shall be at least thirty-six inches (.091 m) high. Those installed after October 3, 1983, shall be forty-two inches (1.07 m) high, plus or minus two inches (5.1 cm), high.

(d) Any nonrigid railing such as chain or wire rope shall have a maximum sag, at the mid-point between posts, of not more than six inches (15.2 cm).

(e) Top rails shall be free of sharp edges and maintained in good repair.

(f) Rail ends shall not overhang. This does not prohibit scrollwork, boxed ends or similar nonhazardous projections.

(4) Toeboards. Toeboards shall be provided when employees below could be exposed to falling objects such as tools. Toeboards shall be at ~~(least)~~ least three and one-half inches (8.9 cm) in height from top edge to floor level, and be capable of withstanding a force of fifty pounds (220 N) applied in any direction. Drainage clearance not in excess of one-eighth inch under toeboards is permitted.

(5) Stair railings. Stair railings shall be capable of withstanding a force of at least two hundred pounds (890 N) applied in any direction, and shall not be more than thirty-six inches (0.9 m) nor less than thirty-two inches (0.8 m) in height from the upper top rail surface to the tread surface in line with the leading edge of the tread. Railings and midrails shall be provided at any stairway having four or more risers, as follows:

(a) For stairways less than forty-four inches (1.12 m) wide, at least one railing; and

(b) For stairways more than forty-four inches (1.12 m) but less than eighty-eight inches (2.24 m) wide, a stair rail or handrail on each side, and if eighty-eight or more inches wide, an additional intermediate handrail.

(6) Condition. Railings shall be maintained free of sharp edges and in good repair.

**AMENDATORY SECTION** (Amending Order 86-02, filed 1/17/86)

WAC 296-56-60131 ELEVATORS AND ESCALATORS. (1) "Elevator" means a permanent hoisting and lowering mechanism with a car or platform moving vertically in guides and serving two or more floors of a structure. The term excludes such devices as conveyors, tiering or piling machines, material hoists, skip or furnace hoists, wharf ramps, lift bridges, car lifts, and dumpers.

(2) "Escalator" means a power-driven continuous moving stairway principally intended for the use of persons.

(3) No elevator or escalator with a defect which (~~adversely~~) affects safety shall be used.

(4) Elevator safety devices shall not be overridden or made inoperable.

(5) Elevators and escalators shall be thoroughly inspected at intervals not exceeding one year. Additional monthly inspections for satisfactory operation shall be conducted by designated persons. Records of the results of the latest annual elevator inspections shall be posted in elevators. Records of annual escalator inspections shall be posted in the vicinity of the escalator or be available at the terminal.

(6) Elevator landing openings shall be provided with doors, gates, or equivalent protection, which shall be in place when the elevator is not at that landing, to prevent employees from falling into the shaft.

(7) The elevator or escalator maximum load limits shall be posted and shall not be exceeded. Elevator load limits shall be posted conspicuously both inside and outside of the car.

(8) Elevators shall be operated only by designated persons except for automatic or door interlocking elevators which provide full shaft door closing and automatic car leveling.

**AMENDATORY SECTION** (Amending Order 86-02, filed 1/17/86)

WAC 296-56-60209 FIXED LADDERS. (1) Scope. This section applies to all fixed ladders except:

(a) Ladders forming an integral part of railway cars, highway carriers, cargo containers, or other transportation carrier equipment;

(b) Climbing devices such as step bolts or structural members of tanks and towers;

(c) Ladders built into or vertically attached to tubular scaffold framing; and

(d) Ladders used only for fire fighting or emergency purposes are exempt from the provisions of subsection (5) of this section. All other requirements of this section apply.

## (2) Definitions.

(a) "Cage" (basket guard) means a barrier enclosing or nearly enclosing a ladder's climbing space and fastened to one or both of the ladder's side rails or to another structure.

(b) "Fixed ladder" means a ladder, including individual rung ladders, permanently attached to a structure, building, or piece of equipment.

(c) "Ladder safety device" means a support system limiting an employee's drop or fall from the ladder, and which may incorporate friction brakes, lifelines and lanyards, or sliding attachments.

(d) "Well" means a permanent complete enclosure around a fixed ladder, which is attached to the walls of the well.

## (3) Defects.

(a) Ladders with broken, split, or missing rungs, steps or rails, broken welds or connections, corrosion or wastage, or other defect which may affect safe use shall be removed from service.

(b) Ladder repairs shall provide strength at least equivalent to that of the original ladder.

## (4) Ladder specifications.

(a)(i) Ladders installed before October 3, 1983, shall be capable of withstanding without damage a minimum concentrated load, applied uniformly over a three and one-half inch (8.8 cm) width at the rung center, of two hundred pounds (890 N).

(ii) Ladders installed after October 3, 1983, shall be capable of withstanding two hundred fifty pounds (1120 N) applied as described in (a)(i) of this subsection. If used by more than one employee simultaneously, the ladder as a unit shall be capable of simultaneous additional loading in two hundred fifty pound (1120 N) increments for each additional employee, applied to a corresponding number of rungs. The unit shall have a safety factor of four based on ultimate strength, in the designed service.

(b)(i) Ladders installed before October 3, 1983, shall have rungs evenly spaced from nine to sixteen and one-half inches (22.9 to 41.9 cm) apart, center to center.

(ii) Ladders installed after October 3, 1983, shall have rungs evenly spaced twelve inches apart, plus or minus two inches (30 cm, plus or minus 5 cm), center to center.

(c)(i) Ladders installed before October 3, 1983, shall have a width between side rails of at least ten inches (25.4 cm).

(ii) Ladders installed after October 3, 1983, shall have a width between side rails of at least twelve inches (30.48 cm).

(d) The minimum distance between the rung center line and the nearest permanent object behind the rung shall be four inches (10.2 cm), except that in ladders installed after October 3, 1983, the minimum distance shall be seven inches (17.8 cm) unless physical limitations make a lesser distance, not less than four and one-half inches (11.5 cm), necessary.

(e) When a ladder passes through an opening or past overhead obstructions, a minimum twenty-four inch (.61 m) clearance shall exist between the climbing side and any obstruction. Where this distance is less than thirty inches (0.76 m), a deflection device shall be installed for guidance through the opening.

(f) The side rails of ladders shall extend at least thirty-six inches (0.91 m) above the top landing surface, unless grab bars or equivalent holds are provided.

(g) Ladders whose pitch exceeds ninety degrees to the horizontal (slanting backward on the climbing side) shall not be used.

(5) Protection against falls.

(a) Fixed ladders more than twenty feet (6.1 m) in height shall be provided with a cage, well, or ladder safety device.

(b) When a well or cage is used, ladders with length of climb exceeding thirty feet (9.14 m) shall comply with the following provisions:

(i) The ladder shall consist of multiple sections not exceeding thirty feet (9.14 m) each;

(ii) Each section shall be horizontally offset from adjacent sections, except as specified in (b)(iv) of this subsection; and

(iii) A landing platform capable of supporting a load of one hundred pounds per square foot (4.79 kPa) and fitted with guardrails complying with WAC 296-56-60123(3) shall be provided at least every thirty feet, except as specified in (b)(iv) of this subsection;

(iv) For ladders installed after October 3, 1983, offset sections and landing platforms are not required if hinged platforms capable of supporting one hundred pounds per square foot (4.79 kPa), and which are kept closed except when opened for passage, are within the cage or well at intervals not exceeding thirty feet (9.14 m).

(c) Ladders equipped with ladder safety devices shall have rest platforms:

(i) Capable of supporting a load of one hundred pounds per square foot (4.79 kPa);

(ii) Located at intervals of one hundred fifty feet (46 m) or less; and

(iii) Protected by guardrails complying with WAC 296-56-60123(3) on three sides.

(d) Where used, ladder safety devices shall:

(i) Be installed and maintained in accordance with the manufacturer's instructions, which shall be available for inspection upon request;

(ii) Be repaired only with replacement parts having performance capability at least equal to that of the original parts;

(iii) Have a connection length between carrier centerlines and safety belts of  $(+0.2)$   $10 \pm 2$  inches  $(\cancel{25.45.08})$   $25.4 \pm 5.08$  cm; and

(iv) Be installed in a manner that does not reduce the ladder's structural capacity.

(e) Ladder cages or wells shall:

(i) Be of rigid construction that allows unobstructed use but prevents an employee from falling through or dislodging the cage or well by falling against it;

(ii) Have smooth inner surfaces;

(iii) Extend at least thirty-six inches (0.9 m) above landings; and

(iv) Extend to within eight feet (2.4 m) above the ground or base, except that a maximum of twenty feet (6.1 m) is permitted where the cage or well would extend into traffic lanes.

(f) Ladders installed after January 1, 1985, on radio, microwave communications, electrical power and similar towers, poles and structures, including stacks and chimneys, shall meet the requirements of this subsection.

(6) Individual rung ladders. Ladders consisting of individual rungs that are attached to walls, conical manhole sections or river cells shall:

(a) Be capable of supporting a load of three hundred fifty pounds (1557 N) without deformation;

(b) Form a continuous ladder, uniformly spaced vertically from twelve inches to sixteen inches (30.5 to 41 cm) apart, with a minimum width of ten inches (25.4 cm), and projecting at least four and one-half inches  $(\cancel{11.43})$   $11.43$  cm from the wall;

(c) Be so constructed that an employee's foot cannot slide off the ends; and

(d) Be firmly attached and without sharp edges.

#### AMENDATORY SECTION (Amending Order 86-02, filed 1/17/86)

WAC 296-56-60215 FIXED STAIRWAYS. (1) Definition. "Fixed stairway" means interior or exterior stairs serving machinery, tanks, or equipment, and stairs to or from floors, platforms, or pits. The term does not apply to stairs intended only for fire exit purposes, to articulated stairs (the angle of which changes with the rise and fall of the base support) or to stairs forming an integral part of machinery.

(2) New installations.

(a) Fixed stairs installed after October 3, 1983, shall be positioned within the range of thirty degrees to fifty degrees to the horizontal with uniform riser height and tread width throughout each run and be capable of a minimum loading of one hundred pounds per square foot (448 N) and a minimum concentrated load of three hundred pounds (1344 N) at the center of any treadspan. Riser height shall be from six to seven and one-half inches (15.2 to 19.0 cm), stair width a minimum of twenty-two inches (56 cm) between vertical barriers, and tread

depth  $(\cancel{\text{shall be from 8 to 11 inches (20.3 to 27.8 cm)}})$  a minimum of  $12 \pm 2$  inches  $(30.48 \pm 5.08 \text{ cm})$ , and tread nosing shall be straight leading edges.

(b) Stair landings shall be at least twenty inches (51 cm) in depth. Where doors or gates open on a stairway, a landing platform shall be provided. Door swing shall not reduce the effective standing area on the landing to less than eighteen inches (45.7 cm) in depth.

(c) Fixed stairs having four or more risers shall have stair railings or handrails complying with WAC 296-56-60123(3).

(d) The railing height from tread surface at the riser face shall be 33 plus or minus 3 inches (83 plus or minus 7.6 cm).

(e) Restricted areas. When physical features require stairs steeper than those provided for by (a) of this subsection, stairs at angles of fifty degrees to seventy-five degrees from the horizontal may be used if they:

(i) Are capable of supporting a single concentrated load of two hundred pounds (890 N) at the tread centers;

(ii) Have open treads at least four inches (10.2 cm) in depth and eighteen inches (45.7 cm) in width with a uniformly spaced vertical rise between treads of six to nine and one-half inches (15.2 to 24.1 cm); and

(iii) Have handrails that meet the requirements of WAC 296-56-60123(3) on both sides that are not less than thirty inches (76.2 cm) in height from the tread surface at the riser face.

(f) Maintenance. Fixed stairways shall be maintained in safe condition and shall not be obstructed.

#### AMENDATORY SECTION (Amending Order 86-02, filed 1/17/86)

WAC 296-56-60223 PASSAGE BETWEEN LEVELS AND ACROSS OPENINGS. (1) General. The employer shall provide safe means of passage between different surface levels and across openings.

(2) Definitions.

(a) "Dockboards (car and bridge plates)" mean devices for spanning short distances between rail cars or highway vehicles and loading platforms which do not expose employees to falls greater than four feet (1.2 m).

(b) "Ramps" means other flat-surface devices for passage between levels and across openings not included in "dockboards."

(3) Dockboards (car and bridge plates).

(a) Dockboards shall be strong enough to support the loads imposed on them.

(b) Portable dockboards shall be anchored in position or be equipped with devices to prevent their movement.

(c) Hand holds or other effective means shall be provided on portable dockboards to permit safe handling.

(d) Positive means shall be used to prevent railcars or highway vehicles from being moved while dockboards or bridge plates are in position.

(4) Ramps.

(a) Ramps shall be strong enough to support the loads imposed on them, provided with sideboards, properly secured and well maintained.

(b) Ramps shall be equipped with guardrails meeting the requirements of WAC 296-56-60123(3) if the slope is more than twenty degrees to the horizontal or if employees could fall more than four feet (1.2 m).

(c) Ramps shall have slip-resistant surfaces.

(d) When necessary to prevent displacement by vehicle wheels, steel plates or similar devices, used to temporarily bridge(;) or cover uneven surfaces or tracks, shall be anchored.

#### AMENDATORY SECTION (Amending Order 91-01, filed 5/20/91, effective 6/20/91)

WAC 296-56-60229 SANITATION. (1) Washing and toilet facilities.

(a) The employer shall provide accessible washing and toilet facilities sufficient for the sanitary requirements of employees. The facilities shall have:

(i) Running water, including hot(;) and cold or tepid water (when cargo handling is conducted at locations without permanent facilities, containers of potable water may be provided in lieu of running water);

(ii) Soap;

(iii) Individual hand towels, clean individual sections of continuous toweling or warm air blowers; and

(iv) Fixed or portable toilets in separate compartments with latch-equipped doors.

(b) Separate toilet facilities shall be provided for male and female employees except when toilet rooms are occupied by only one person at a time. A means of locking shall be provided.

(c) Washing and toilet facilities shall be regularly cleaned and maintained in good order.

(2) Drinking water.

(a) Potable drinking water shall be accessible to employees at all times.

(b) Potable drinking water containers shall be clean, containing only water and ice, and shall be fitted with covers.

(c) Common drinking cups are prohibited.

(3) Prohibited eating areas. Consumption of food or beverages in areas where hazardous materials are being stored or handled shall be prohibited.

(4) Garbage and overboard discharges. Work shall not be conducted in the immediate vicinity of uncovered garbage or in the area of overboard discharges from the vessel's sanitary lines unless employees are protected from the garbage or discharge by a baffle or splash boards.

#### AMENDATORY SECTION (Amending Order 86-02, filed 1/17/86)

WAC 296-56-60235 WELDING, CUTTING AND HEATING (HOT WORK). (1) Definition. "Hot work" means riveting, welding, flame cutting or other fire or spark-producing operation.

(2) Hot work in confined spaces. Hot work shall not be performed in a confined space until a designated person has tested the atmosphere and determined that it is not hazardous.

(3) Fire protection.

(a) To the extent possible, hot work shall be performed in designated locations that are free of fire hazards.

(b) When hot work must be performed in a location that is not free of fire hazards, all necessary precautions shall be taken to confine heat, sparks, and slag so that they cannot contact flammable or combustible material.

(c) Fire extinguishing equipment suitable for the location shall be immediately available and shall be maintained in readiness for use at all times.

(d) When the hot work operation is such that normal fire prevention precautions are not sufficient, additional personnel shall be assigned to guard against fire during hot work and for a sufficient time after completion of the work to ensure that no fire hazard remains. The employer shall instruct all employees involved in hot work operations as to potential fire hazards and the use of fire fighting equipment.

(e) Drums and containers which contain or have contained flammable or combustible liquids shall be kept closed. Empty containers shall be removed from the hot work area.

(f) When openings or cracks in flooring cannot be closed, precautions shall be taken to ensure that no employees or flammable or combustible materials are exposed to sparks dropping through the floor. Similar precautions shall be taken regarding cracks or holes in walls, open doorways and open or broken windows.

(g) Hot work shall not be performed:

(i) In flammable or potentially flammable atmospheres;

(ii) On or in equipment or tanks that have contained flammable gas or liquid or combustible liquid or dust-producing material, until a designated person has tested the atmosphere inside the equipment or tanks and determined that it is not hazardous; or

(iii) Near any area in which exposed readily ignitable materials such as bulk sulphur, baled paper or cotton are stored. Bulk sulphur is excluded from this prohibition if suitable precautions are followed, the person in charge is knowledgeable and the person performing the work has been instructed in preventing and extinguishing sulphur fires.

(h)(i) Drums, containers or hollow structures that have contained flammable or combustible substances shall either be filled with water or cleaned, and shall then be ventilated. A designated person shall test the atmosphere and determine that it is not hazardous before hot work is performed on or in such structures.

(ii) Before heat is applied to a drum, container or hollow structure, an opening to release built-up pressure during heat application shall be provided.

(4) Gas welding and cutting.

(a) Compressed gas cylinders:

(i) Shall have valve protection caps in place except when in use, hooked up or secured for movement. Oil shall not be used to lubricate caps;

(ii) Shall be hoisted only while secured, as on a cradle or pallet, and shall not be hoisted by magnet, choker sling or cylinder caps;

(iii) Shall be moved only by tilting or rolling on their bottom edges;

(iv) Shall be secured when moved by vehicle;

(v) Shall be secured while in use;

(vi) Shall have valves closed when cylinders are empty, being moved or stored;

(vii) Shall be secured upright except when hoisted or carried;

(viii) Shall not be freed when frozen by prying the valves or caps with bars or by hitting the valve with a tool;

(ix) Shall not be thawed by boiling water;

(x) Shall not be exposed to sparks, hot slag, or flame;

(xi) Shall not be permitted to become part of electrical circuits or have electrodes struck against them to strike arcs;

(xii) Shall not be used as rollers or supports;

(xiii) Shall not have contents used for purposes not authorized by the supplier;

(xiv) Shall not be used if damaged or defective;

(xv) Shall not have gases mixed within, except by gas suppliers;

(xvi) Shall be stored so that oxygen cylinders are separated from fuel gas cylinders and combustible materials by either a minimum distance of twenty feet (6 m) or a barrier having a fire-resistance rating of thirty minutes; and

(xvii) Shall not have objects that might either damage the safety device or obstruct the valve placed on top of the cylinder when in use.

(b) Use of fuel gas. Fuel gas shall be used only as follows:

(i) Before regulators are connected to cylinder valves, the valves shall be opened slightly (cracked) and closed immediately to clear away dust or dirt. Valves shall not be cracked if gas could reach possible sources of ignition;

(ii) Cylinder valves shall be opened slowly to prevent regulator damage and shall not be opened more than one and one-half turns. Any special wrench required for emergency closing shall be positioned on the valve stem during cylinder use. For manifolded or coupled cylinders, at least one wrench shall be immediately available. Nothing shall be placed on top of a cylinder or associated parts when the cylinder is in use;

(iii) Pressure-reducing regulators shall be attached to cylinder valves when cylinders are supplying torches or devices equipped with shut-off valves;

(iv) Cylinder valves shall be closed and gas released from the regulator or manifold before regulators are removed;

(v) Leaking fuel gas cylinder valves shall be closed and the gland nut tightened. If the leak continues, the cylinder shall be tagged, removed from service, and moved to a location where the leak will not be hazardous. If a regulator attached to a valve stops a leak, the cylinder need not be removed from the workplace but shall be tagged and may not be used again before it is repaired; and

(vi) If a plug or safety device leaks, the cylinder shall be tagged, removed from service, and moved to a location where the leak will not be hazardous.

(c) Hose.

(i) Fuel gas and oxygen hoses shall be easily distinguishable from each other by color or sense of touch. Oxygen and fuel hoses shall not be interchangeable. Hoses having more than one gas passage shall not be used.

(ii) When oxygen and fuel gas hoses are taped together, not more than four of each twelve inches (10.2 cm of each 30.5 cm) shall be taped.

(iii) Hose shall be inspected before use. Hose subjected to flashback or showing evidence of severe wear or damage shall be tested to twice the normal working pressure but not less than two hundred p.s.i. (1378.96 kPa) before re-use. Defective hose shall not be used.

(iv) Hose couplings shall not unlock or disconnect without rotary motion.

(v) Hose connections shall be clamped or securely fastened to withstand twice the normal working pressure but not less than three hundred p.s.i. (2068.44 kPa) without leaking.

(vi) Gas hose storage boxes shall be ventilated.

(d) Torches.

(i) Torch tip openings shall only be cleaned with devices designed for that purpose.

(ii) Torches shall be inspected before each use for leaking shut-off valves, hose couplings and tip connections. Torches shall be inspected before each use for leaking shut-off valves, hose couplings and tip connections. Torches with such defects shall not be used.

(iii) Torches shall not be lighted from matches, cigarette lighters, other flames or hot work.

(e) Pressure regulators. Pressure regulators, including associated gauges, shall be maintained in safe working order.

(f) Operational precaution. Gas welding equipment shall be maintained free of oil and grease.

(5) Arc welding and cutting.

(a) Manual electrode holders.

(i) The employer shall ensure that only manual electrode holders intended for arc welding and cutting and capable of handling the maximum current required for such welding or cutting shall be used.

(ii) Current-carrying parts passing through those portions of the holder gripped by the user and through the outer surfaces of the jaws of the holder shall be insulated against the maximum voltage to ground.

(b) Welding cables and connectors.

(i) Arc welding and cutting cables shall be insulated, flexible and capable of handling the maximum current required by the operation, taking into account the duty cycles.

(ii) Only cable free from repair or splice for ten feet (3 m) from the electrode holder shall be used unless insulated connectors or splices with insulating quality equal to that of the cable are provided.

(iii) When a cable other than the lead mentioned in (b)(ii) of this subsection wears and exposes bare conductors, the portion exposed shall not be used until it is protected by insulation equivalent in performance capacity to the original.

(iv) Insulated connectors of equivalent capacity shall be used for connecting or splicing cable. Cable lugs, where used as connectors, shall provide electrical contact. Exposed metal parts shall be insulated.

(c) Ground returns and machine grounding.

(i) Ground return cables shall have current-carrying capacity equal to or exceeding the total maximum output capacities of the welding or cutting units served.

(ii) Structures or pipelines, other than those containing gases or flammable liquids or conduits containing electrical circuits, may be used in the ground return circuit if their current-carrying capacity equals or exceeds the total maximum output capacities of the welding or cutting units served.

(iii) Structures or pipelines forming a temporary ground return circuit shall have electrical contact at all joints. Arcs, sparks or heat at any point in the circuit shall cause rejection as a ground circuit.

(iv) Structures or pipelines acting continuously as ground return circuits shall have joints bonded and maintained to ensure that no electrolysis or fire hazard exists.

(v) Arc welding and cutting machine frames shall be grounded, either through a third wire in the cable containing the circuit conductor or through a separate wire at the source of the current. Grounding circuits shall have resistance low enough to permit sufficient current to flow to cause the fuse or circuit breaker to interrupt the current.

(vi) Ground connections shall be mechanically and electrically adequate to carry the current.

(d) When electrode holders are left unattended, electrodes shall be removed and holders placed to prevent employee injury.

(e) Hot electrode holders shall not be dipped in water.

(f) The employer shall ensure that when arc welders or cutters leave or stop work or when machines are moved, the power supply switch is kept in the off position.

(g) Arc welding or cutting equipment having a functional defect shall not be used.

(h)(i) Arc welding and cutting operations shall be separated from other operations by shields, screens, or curtains to protect employees in the vicinity from the direct rays and sparks of the arc.

(ii) Employees in areas not protected from the arc by screening shall be protected by appropriate filter lenses in accordance with subsection (8) of this section. When welders are exposed to their own arc or to each other's arc, they shall wear filter lenses complying with the requirements of subsection (8) of this section.

(i) The control apparatus of arc welding machines shall be enclosed, except for operating wheels, levers, and handles.

(j) Input power terminals, top change devices and live metal parts connected to input circuits shall be enclosed and accessible only by means of insulated tools.

(k) When arc welding is performed in wet or high-humidity conditions, employees shall use additional protection, such as rubber pads or boots, against electric shock.

(6) Ventilation and employee protection in welding, cutting and heating.

(a) Mechanical ventilation requirements. The employer shall ensure that general mechanical ventilation or local exhaust systems shall meet the following requirements:

(i) General mechanical ventilation shall maintain vapors, fumes and smoke below a hazardous level;

(ii) Local exhaust ventilation shall consist of movable hoods positioned close to the work and shall be of such capacity and arrangement as to keep breathing zone concentrations below hazardous levels;

(iii) Exhausts from working spaces shall be discharged into the open air, clear of intake air sources;

(iv) Replacement air shall be clean and respirable; and

(v) Oxygen shall not be used for ventilation, cooling or cleaning clothing or work areas.

(b) Hot work in confined spaces. Except as specified in (c) (ii) and (iii) of this subsection, when hot work is performed in a confined space the employer shall, in addition to the requirements of WAC 296-62-145 through 296-62-14529, ensure that:

(i) General mechanical or local exhaust ventilations shall be provided; or

(ii) Employees in the space shall wear supplied air respirators in accordance with WAC 296-62-071 et seq. and a standby observer on the outside shall maintain communication with employees inside the space and shall be equipped and prepared to provide emergency aid.

(c) Welding, cutting or heating of toxic metals.

(i) In confined or enclosed spaces, hot work involving the following metals shall only be performed with general mechanical or local exhaust ventilation that ensures that employees are not exposed to hazardous levels of fumes:

(A) Lead base metals;

(B) Cadmium-bearing filler materials; and

(C) Chromium-bearing metals or metals coated with chromium-bearing materials.

(ii) In confined or enclosed spaces, hot work involving the following metals shall only be performed with local exhaust ventilation meeting the requirements of this subsection or by employees wearing supplied air respirators in accordance with chapter 296-62 WAC;

(A) Zinc-bearing base or filler metals or metals coated with zinc-bearing materials;

(B) Metals containing lead other than as an impurity, or coated with lead-bearing materials;

(C) Cadmium-bearing or cadmium-coated base metals; and

(D) Metals coated with mercury-bearing materials.

(iii) Employees performing hot work in confined or enclosed spaces involving beryllium-containing base or filler metals shall be protected by local exhaust ventilation and wear supplied air respirators or self-contained breathing apparatus, in accordance with the requirements of chapter 296-62 WAC.

(iv) The employer shall ensure that employees performing hot work in the open air that involves any of the metals listed in (c)(i) and (ii) of this subsection shall be protected by respirators in accordance with the requirements of chapter 296-62 WAC and those working on beryllium-containing base or filler metals shall be protected by supplied air respirators, in accordance with the requirements of chapter 296-62 WAC.

(v) Any employee exposed to the same atmosphere as the welder or burner shall be protected by the same type of respiratory and other protective equipment as that worn by the welder or burner.

(d) Inert-gas metal-arc welding. Employees shall not engage in and shall not be exposed to the inert-gas metal-arc welding process unless the following precautions are taken:

(i) Chlorinated solvents shall not be used within two hundred feet (61 m) of the exposed arc. Surfaces prepared with chlorinated solvents shall be thoroughly dry before welding is performed on them.

(ii) Employees in areas not protected from the arc by screening shall be protected by appropriate filter lenses in accordance with the requirements of subsection (8) of this section. When welders are exposed to their own arc or to each other's arc, filter lenses complying with the requirements of subsection (8) of this section shall be worn to protect against flashes and radiant energy.

(iii) Employees exposed to radiation shall have their skin covered completely to prevent ultraviolet burns and damage. Helmets and hand shields shall not have leaks, openings or highly reflective surfaces.

(iv) Inert-gas metal-arc welding on stainless steel shall not be performed unless exposed employees are protected either by local exhaust ventilation or by wearing supplied air respirators.

(7) Welding, cutting and heating on preservative coatings.

(a) Before hot work is commenced on surfaces covered by a preservative coating of unknown flammability, a test shall be made by a designated person to determine the coating's flammability. Preservative



coatings shall be considered highly flammable when scrapings burn with extreme rapidity.

(b) Appropriate precaution(;) shall be taken to prevent ignition of highly flammable hardened preservative coatings. Highly flammable coatings shall be stripped from the area to be heated. An uncoiled fire hose with fog nozzle, under pressure, shall be immediately available in the hot work area.

(c) Surfaces covered with preservative coatings shall be stripped for at least four inches (10.2 cm) from the area of heat application or employees shall be protected by supplied air respirators in accordance with the requirements of chapter 296-62 WAC.

(8) Protection against radiant energy.

(a) Employees shall be protected from radiant energy eye hazards by spectacles, cup goggles, helmets, hand shields or face shields with filter lenses complying with the requirements of this subsection.

(b) Filter lenses shall have an appropriate shade number, as indicated in Table G-1, for the work performed. Variations of one or two shade numbers are permissible to suit individual preferences.

(c) If filter lenses are used in goggles worn under the helmet, the shade numbers of both lenses equals the value shown in Table G-1 for the operation.

Table G-1.—Filter Lenses for Protection Against Radiant Energy

Operation	Shade No.
Soldering	2
Torch Brazing	3 or 4
Light cutting, up to 1 inch	3 or 4
Medium cutting, 1-6 inches	4 or 5
Heavy cutting, over 6 inches	5 or 6
Light gas welding, up to 1/8 inch	4 or 5
Medium gas welding, 1/8-1/2 inch	5 or 6
Heavy gas welding, over 1/2 inch	6 or 8
Shielded Metal-Arc Welding 1/16 to 5/32-inch electrodes	10
Inert gas Metal-Arc Welding (non-ferrous) 1/16 to 5/32-inch electrodes	11
Shielded Metal-Arc Welding: 3/16 to 1/4-inch electrodes	12
5/16 and 3/8-inch electrodes	14

**AMENDATORY SECTION** (Amending Order 91-07, filed 11/22/91, effective 12/24/91)

WAC 296-56-60237 SPRAY PAINTING. (1) Scope. This section covers painting operations connected with maintenance of structures, equipment and gear at the marine terminal and of transient equipment serviced at the terminal. It does not apply to overall painting of terminal structures under construction, major repair or rebuilding of terminal structures, or portable spraying apparatus not used regularly in the same location.

(2) Definitions.

(a) "Spraying area" means any area where flammable vapors, mists or combustible residues, dusts or deposits may be present due to paint spraying operations.

(b) "Spray booth" means an enclosure containing a flammable or combustible spraying operation and confining and limiting the escape of paint, vapor and residue by means of a powered exhaust system.

(c) "Approved" means, for the purpose of this section, that the equipment has been approved for the specified use by a nationally recognized testing laboratory.

(3) Spray painting requirements for indoor and outdoor spraying areas and booths.

(a) Shut-off valves, containers or piping with attached hoses or flexible connections shall have shut-off valves closed at the connection when not in use.

(b) Pumps used to transfer paint supplies shall have automatic pressure-relieving devices.

(c) Hoses and couplings shall be inspected before use. Hoses showing deterioration, leakage or weakness in the carcass or at the couplings shall be removed from service.

(d)(i) No open flame or spark-producing equipment shall be within ((20)) twenty feet (6 m) of a spraying area unless it is separated from the spraying area by a fire-retardant partition.

(ii) Hot surfaces shall not be located in spraying areas.

(iii) Whenever combustible residues may accumulate on electrical installations, wiring shall be in rigid conduit or in boxes containing no taps, splices or connections.

(iv) Portable electric lights shall not be used during spraying operations. Lights used during cleaning or repairing operations shall be approved for the location in which they are used.

(e) When flammable or combustible liquids are being transferred between containers, both containers shall be bonded and grounded.

(f)(i) Spraying shall be performed only in designated spray booths or spraying areas.

(ii) Spraying areas shall be kept as free from combustible residue accumulations as practical.

(iii) Residue scrapings, debris, rags, and waste shall be removed from the spraying area as they accumulate.

(g) Spraying with organic peroxides and other dual-component coatings shall only be conducted in sprinkler-equipped spray booths.

(h) Only the quantity of flammable or combustible liquids required for the operation shall be allowed in the spraying area, and in no case shall the amount exceed a one-day supply.

(i) Smoking shall be prohibited and "No Smoking" signs shall be posted in spraying and paint storage areas.

(4) Additional requirements for spraying areas and spray booths.

(a) Distribution or baffle plates shall be of noncombustible material and shall be removable or accessible for cleaning. They shall not be located in exhaust ducts.

(b) Any discarded filter shall be removed from the work area or placed in water.

(c) Filters shall not be used when the material being sprayed is highly susceptible to spontaneous heating and ignition.

(d) Filters shall be noncombustible or of an approved type. The same filter shall not be used when spraying with different coating materials if the combination of materials may spontaneously ignite.

(e) Spraying areas shall be mechanically ventilated for removal of flammable and combustible vapor and mist.

(f) Mechanical ventilation shall be in operation during spraying operations and long enough thereafter to ((thoroughly)) exhaust hazardous vapor concentrations.

(g) Rotating fan elements shall be nonsparking or the casing shall consist of or be lined with nonsparking material.

(h) Piping systems conveying flammable or combustible liquids to the spraying booth or area shall be made of metal and be both electrically bonded and grounded.

(i) Air exhausted from spray operations shall not contaminate makeup air or other ventilation intakes. Exhausted air shall not be recirculated unless it is first cleaned of any hazardous contaminants.

(j) Original closed containers, approved portable tanks, approved safety cans or a piping system shall be used to bring flammable or combustible liquids into spraying areas.

(k) If flammable or combustible liquids are supplied to spray nozzles by positive displacement pumps, the pump discharge line shall have a relief valve discharging either to a pump section or detached location, or the line shall be equipped with a device to stop the prime mover when discharge pressure exceeds the system's safe operating pressure.

(l) Wiring, motors and equipment in a spray booth shall be of approved explosion-proof type for Class I, Group D locations and conform with the requirements of chapter 296-24 WAC Part L for Class I, Division 1, Hazardous Locations. Wiring, motors and equipment within ((20)) twenty feet (6 m) of any interior spraying area and not separated by vapor-tight partitions shall not produce sparks during operation and shall conform to the requirements of chapter 296-24 WAC Part L for Class I, Division 2, Hazardous Locations.

(m) Outside electrical lights within ((10)) ten feet (3 m) of spraying areas and not separated from the areas by partitions shall be enclosed and protected from damage.

(5) Additional requirements for spray booths.

(a) Spray booths shall be substantially constructed of noncombustible material and have smooth interior surfaces. Spray booth floors shall be covered with noncombustible material. As an aid to cleaning, paper may be used to cover the floor during painting operations if it is removed after the painting is completed.

(b) Spray booths shall be separated from other operations by at least 3 feet (0.91 m) or by fire-retardant partitions or walls.

(c) A space of at least 3 feet (0.91 m) on all sides of the spray booth shall be maintained free of storage or combustible materials.

(d) Metal parts of spray booths, exhaust ducts, pipings, airless high-pressure spray guns and conductive objects being sprayed shall be grounded.

(e) Electric motors driving exhaust fans shall not be located inside booths or ducts.

(f) Belts shall not enter ducts or booths unless the belts are completely enclosed.

(g) Exhaust ducts shall be made of steel, shall have sufficient access doors to permit cleaning, and shall have a minimum clearance of 18 inches (0.46 m) from combustible materials. Any installed dampers shall be fully opened when the ventilating system is operating.

(h) Spray booths shall not be alternately used to spray different types of coating materials if the combination of the materials may spontaneously ignite unless deposits of the first material are removed from the booth and from exhaust ducts before spraying of the second material begins.

**AMENDATORY SECTION** (Amending Order 86-02, filed 1/17/86)

WAC 296-56-60239 COMPRESSED AIR. Employees shall be protected by appropriate eye protection and personal protective equipment complying with the requirements of WAC ((296-56-60019)) 296-56-60109 through 296-56-60115 during cleaning with compressed air. Compressed air used for cleaning shall not exceed a pressure of thirty p.s.i. Compressed air shall not be used to clean employees.

**AMENDATORY SECTION** (Amending Order 86-02, filed 1/17/86)

WAC 296-62-09005 NONIONIZING RADIATION. (1) Introduction. Employees shall be protected from exposure to hazardous levels of nonionizing radiation. Health standards have been established for ultraviolet, radiofrequency/microwave, and laser radiations which shall be used to promote a healthful working environment. These standards refer to levels of nonionizing radiation and represent conditions under which it is believed that nearly all workers may be repeatedly exposed day after day without adverse effects. They are based on the best available information from experimental studies. Because of the wide variations in individual susceptibility, exposure of an occasional individual at, or even below, the permissible limit, may result in discomfort, aggravation of a preexisting condition, or physiological damage.

(a) Permissible exposure limits (PELs) refer to a time weighted average (TWA) of exposure for an 8-hour work day within a 40-hour workweek. Exceptions are those limits which are given a ceiling value.

(b) These PELs should be interpreted and applied only by technically qualified persons.

(c) Ceiling value. There are nonionizing radiations which produce physiological responses from short intense exposure and the PELs for these radiations are more appropriately based on this particular hazard. Nonionizing radiations with this type of hazard are best controlled by a ceiling value which is a maximum level of exposure which shall not be exceeded.

(2) The employer shall establish and maintain a program for the control and monitoring of nonionizing radiation hazards. This program shall provide employees adequate supervision, training, facilities, equipment, and supplies, for the control and assessment of nonionizing radiation hazards.

(3) Radiofrequency/microwave radiation permissible exposure limits.

(a) Definition: "Partial body exposure" means the case in which only the hands and forearms or the feet and legs below the knee are exposed.

(b) Warning symbol.  
 (i) The warning symbol for radiofrequency/microwave radiation shall consist of a red isosceles triangle above an inverted black isosceles triangle, separated and outlined by an aluminum color border. The words "Warning - Radiofrequency/microwave radiation hazard" shall appear in the upper triangle. See Figure 1.

(ii) All areas where entry may result in an exposure to radiofrequency/microwave radiation in excess of the PEL shall have a warning symbol prominently displayed at their entrance.

(iii) American National Standard Safety Color Code for Marking Physical Hazards and the Identification of Certain Equipment, Z53.1-1953, shall be used for color specification. All lettering and the border shall be of aluminum color.

(iv) The inclusion and choice of warning information or precautionary instructions is at the discretion of the user. If such information is included it shall appear in the lower triangle of the warning symbol.

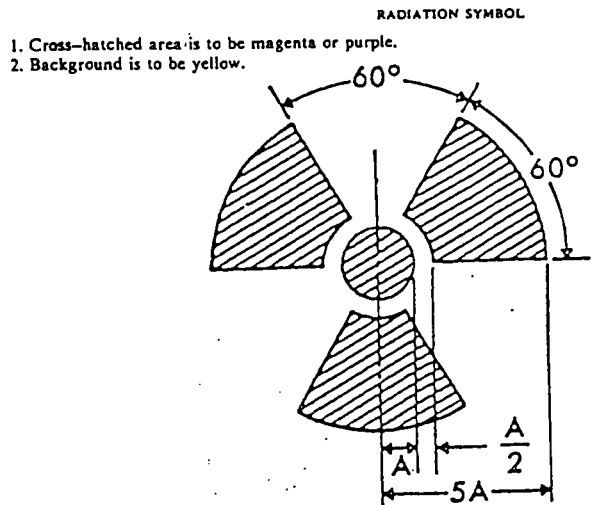

FIGURE G-10

(c) These PELs refer to radiofrequency/microwave radiation exposures in the frequency range of 300 kHz to 100 GHz. Based on current knowledge, it is believed that workers may be exposed at these PELs without adverse health effects.

(i) Table I gives the PELs in terms of the mean squared electric ( $E^2$ ) and magnetic ( $H^2$ ) field strengths and in terms of the equivalent plane-wave free-space power density, as a function of frequency.

(ii) The average exposure for any 6 minute (0.1 hour) period shall not exceed the PEL.

(iii) Measurements shall be made at distances of 5 cm or greater from any object.

(iv) For mixed or broadband fields at a number of frequencies for which there are different PELs, the fraction of the PEL incurred within each frequency interval shall be determined and the sum of these fractions shall not exceed unity.

(v) PELs given in Table I for frequencies between 300 kHz and 1 GHz may be exceeded for partial body exposures if the output power of the radiating device is 7 watts or less.

Table I. Radiofrequency/Microwave Radiation Permissible Exposure Limits (PELs).

Frequency(f)	Power Density*	Electric Field Strength Squared*	Magnetic Field Strength Squared*
	mW/cm <sup>2</sup>	V <sup>2</sup> /m <sup>2</sup>	A <sup>2</sup> /m <sup>2</sup>
0.3 to 3 MHz	100	400,000	2.5
3 to 30 MHz	900/f <sup>2</sup>	4000(900/f <sup>2</sup> )	0.025(900/f <sup>2</sup> )
30 to 300 MHz	1.0	4000	0.025
300 to 1500 MHz	f/300	4000(f/300)	0.025(f/300)
1.5 to 100 GHz	5.0	20,000	0.125

Note: f=frequency (MHz)  
 \* Ceiling value

(4) Laser radiation permissible exposure limits.

(a) Definitions.

(i) "Diffuse reflection" means a change of the spatial distribution of a beam of radiation when it is reflected in many directions by a surface or medium.

(ii) "Specular reflection" means a mirrorlike reflection.

(iii) "Accessible radiation" means laser radiation to which human access is possible.

(b) All lasers and laser systems shall be classified in accordance with the Federal Laser Product Performance Standards (21 CFR 1040.10) or, if manufactured prior to August 2, 1976, in accordance with ANSI Z136.1-1980.

(i) Class I. Laser systems that are considered to be incapable of producing damaging radiation levels and are thereby exempt from control measures. This is a no hazard category.



(ii) Class II. Visible wavelength laser systems that have a low hazard potential because of the expected aversion response. There is some possibility of injury if stared at. This is a low hazard category.

(iii) Class III. Laser systems in which intrabeam viewing of the direct beam or specular reflections of the beam may be hazardous. This class is further subdivided into IIIa and IIIb. This is a moderate hazard category.

(iv) Class IV. Laser systems whose direct or diffusely reflected radiation may be hazardous and where the beam may constitute a fire hazard. Class IV systems require the use of controls that prevent exposure of the eye and skin to specular or diffuse reflections of the beam. This is a high hazard category.

(c) Warning signs and classification labels shall be prepared in accordance with 21 CFR 1040.10 when classifying lasers and laser systems, and ANSI Z136.1 - 1980 when using classified lasers and laser systems. All signs and labels shall be conspicuously displayed.

(i) The signal word "CAUTION" shall be used with all signs and labels associated with Class II and Class IIIa lasers and laser systems.

(ii) The signal word "DANGER" shall be used with all signs and labels associated with Class IIIb and Class IV lasers and laser systems.

(d) Personal protective equipment shall be provided at no cost to the employee and shall be worn whenever operational conditions or maintenance of lasers may result in a potentially hazardous exposure.

(i) Protective eyewear shall be specifically designed for protection against radiation of the wavelength and radiant energy of the laser or laser system. Ocular exposure shall not exceed the recommendations of ANSI Z136.1 - 1980.

(ii) For Class IV lasers and laser systems protective eyewear shall be worn for all operational conditions or maintenance which may result in exposures to laser radiation.

(e) Engineering controls shall be used whenever feasible to reduce the accessible radiation levels for Class IV lasers and laser systems to a lower classification level. These controls may include, but are not limited to: Protective housings, interlocks, optical system attenuators, enclosed beam paths, remote controls, beam stops, and emission delays with audible warnings.

(f) All employees who may be exposed to laser radiation shall receive laser safety training. The training shall ensure that the employees are knowledgeable of the potential hazards and control measures for the laser equipment in use.

(5) Ultraviolet radiation.

(a) These permissible exposure limits refer to ultraviolet radiation in the spectral region between 200 and 400 nanometer (nm) and represent conditions under which it is believed that nearly all workers may be repeatedly exposed without adverse effect. These values for exposure of the eye or the skin apply to ultraviolet radiation from arcs, gas, and vapor discharges, and incandescent sources, but do not apply to ultraviolet lasers or solar radiation. These levels should not be used for determining exposure of photosensitive individuals to ultraviolet radiation. These values shall be used in the control of exposure to continuous sources where the exposure relation shall not be less than 0.1 sec.

(b) The permissible exposure limit for occupational exposure to ultraviolet radiation incident upon skin or eye where irradiance values are known and exposure time is controlled are as follows:

(i) For the near ultraviolet spectral region (320 to 400 nanometer (nm)), total irradiance incident upon the unprotected skin or eye shall not exceed 1.0 milliwatt/sq. centimeter for periods greater than 10<sup>3</sup> seconds (approximately 16 minutes) and for exposure times less than 10<sup>2</sup> seconds shall not exceed one Joule/sq. centimeter.

(ii) For the actinic ultraviolet spectral region (200 - 315 nm), radiant exposure incident upon the unprotected skin or eye shall not exceed the values given in Table 4 within an 8-hour period.

(iii) To determine the effective irradiance of a broadband source weighted against the peak of the spectral effectiveness curve (270 nanometer (nm)), the following weighting formulas shall be used.

$$E_{eff} = \sum (E-\text{Lambda}) (S-\text{Lambda}) (\Delta-\text{Lambda})$$

Where:

$E_{eff}$  = effective irradiance relative to a monochromatic source at 270nm

$E-\text{Lambda}$  = spectral irradiance in Watts/sq. centimeter/nanometer.

$S-\text{Lambda}$  = relative spectral effectiveness (unitless)

$\Delta-\text{Lambda}$  = band width in nanometers

(iv) Permissible exposure time in seconds for exposure to actinic ultraviolet radiation incident upon the unprotected skin or eye may be computed by dividing 0.003 Joules/sq. centimeter by  $E_{eff}$  in Watts/sq. centimeter. The exposure time may also be determined using Table 5 which provides exposure times corresponding to effective irradiances in  $\mu\text{W}/\text{cm}^2$ .

TABLE 4

Wavelength nanometer	PEL millijoules/sq. centimeters	Relative Spectral Effectiveness S Lambda
200	100	0.03
210	40	0.075
220	25	0.12
230	16	0.19
240	10	0.30
250	7.0	0.43
254	6.0	0.5
260	4.6	0.65
270	3.0	1.0
280	3.4	0.88
290	4.7	0.64
300	10	0.30
305	50	0.06
310	200	0.015
315	1000	0.003

TABLE 5

Duration of Exposure Per Day	Effective Irradiance $E_{eff}$ ( $\mu\text{W}/\text{cm}^2$ )
8 hrs.	0.1
4 hrs.	0.2
2 hrs.	0.4
1 hr.	0.8
1/2 hr.	1.7
15 min.	3.3
10 min.	5
5 min.	10
1 min.	50
30 sec.	100
10 sec.	300
1 sec.	3,000
0.5 sec.	6,000
0.1 sec.	30,000

TABLE 6

Densities and Transmissions (in Percent); also Tolerances in Densities and Transmissions of Various Shades of Glasses for Protection Against Injurious Rays

(Shades 3 to 8, inclusive, are for use in goggles, shades 10 to 14, inclusive, for welder's helmets and face shields)

[CODIFICATION NOTE: The graphic presentation of this table has been varied slightly in order that it would fall within the printing specifications for the Washington Administrative Code. In the following table, the original table had columns relating to (1) "Optical Density" which is now "Part 1," (2) "Total Visible Luminous Transmittance" and "Maximum total Infrared" which are now "Part 2," (3) "Maximum Ultraviolet Transmission" which is now "Part 3," and (4) "Recommended Uses" which is now "Part 4." These columns were all positioned side by side. In the new WAC format these are split up into four separate tables.]

TABLE 6--Part 1

Shade No.	Optical Density		
	Minimum O.D.	Standard O.D.	Maximum O.D.
3.0	.64	.857	1.06

TABLE 6—Part 1

Shade No.	Optical Density		
	Minimum O.D.	Standard O.D.	Maximum O.D.
4.0	1.07	1.286	1.49
5.0	1.50	1.714	1.92
6.0	1.93	2.143	2.35
7.0	2.36	2.572	2.78
8	2.79	3.000	3.21
9	3.22	3.429	3.63
10	3.64	3.857	4.06
11	4.07	4.286	4.49
12	4.50	4.715	4.92
13	4.93	5.143	5.35
14	5.36	5.571	5.78

TABLE 6—Part 2

Shade No.	Total Visible Luminous Transmittance			Maximum Total Infrared %
	Maximum %	Standard %	Minimum %	
3.0	22.9	13.9	8.70	9.0
4.0	8.51	5.18	3.24	5.0
5.0	3.16	1.93	1.20	2.5
6.0	1.18	.72	.45	1.5
7.0	.44	.27	.17	1.3
8	.162	.100	.062	1.0
9	.060	.037	.023	.8
10	.0229	.0139	.0087	.6
11	.0085	.0052	.0033	.5
12	.0032	.0019	.0012	.5
13	.00118	.00072	.00045	.4
14	.00044	.00027	.00017	.3

TABLE 6—Part 3

Shade No.	Maximum Ultraviolet Transmission			
	313mu %	334mu %	365mu %	405mu %
3.0	.2	.2	.5	1.0
4.0	.2	.2	.5	1.0
5.0	.2	.2	.2	.5
6.0	.1	.1	.1	.5
7.0	.1	.1	.1	.5
8	.1	.1	.1	.5
9	.1	.1	.1	.5

TABLE 6—Part 3

Shade No.	Maximum Ultraviolet Transmission			
	313mu %	334mu %	365mu %	405mu %
10	.1	.1	.1	.5
11	.05	.05	.05	.1
12	.05	.05	.05	.1
13	.05	.05	.05	.1
14	.05	.05	.05	.1

TABLE 6—Part 4

Shade No.	Recommended Uses
3.0	Glare of reflected sunlight from snow, water, sand, etc., stray light from cutting and welding metal pouring and work around furnaces and foundries.
4.0	
5.0	Light acetylene cutting and welding; light electric spot welding.
6.0	
7.0	Acetylene cutting and medium welding; arc welding up to 30 amperes.
8	
9	Heavy acetylene welding; arc cutting and welding between 30 and 75 amperes.
10	
11	Arc cutting and welding between 75 and 200 amperes.
12	
13	Arc cutting and welding between 200 and 400 amperes.
14	Arc cutting and welding above 400 amperes.

- a. American Standard Safety Code for the Protection of Heads, Eyes, and Respiratory Organs.
- b. Standard density is defined as the logarithms (base 10) of the reciprocal of the transmission. Shade number is determined by the density according to the relations:

Shade number =  $7/3$  density + 1 with tolerances as given in the table.

Note: Safety glasses are available with lenses which protect the eyes against ultraviolet radiation.

**Reviser's note:** RCW 34.05.395 requires the use of underlining and deletion marks to indicate amendments to existing rules. The rule published above varies from its predecessor in certain respects not indicated by the use of these markings.

**AMENDATORY SECTION** (Amending Order 89-03, filed 5/15/89, effective 6/30/89)

**WAC 296-155-48536 FORKLIFT ELEVATED WORK PLATFORMS.** When a forklift truck is used for elevating workers a platform shall be specifically built for that purpose and shall comply with the following requirements:

- (1) The platform shall be securely attached to the forks and shall have standard guardrails and toeboards on all open sides.
- (2) The hydraulic system of the forklift shall be so designed that the lift mechanism will not drop faster than one hundred thirty-five feet per minute in the event of a failure in any part of the system. Forklifts

used for elevating platforms shall be identified that they are so designed.

(3) A safety strap shall be installed or the control lever shall be locked to prevent the boom from tilting.

(4) An operator shall be at the controls of the forklift equipment while persons are on the platform.

(5) The operator shall be in the normal operating position while raising or lowering the platform.

(6) The vehicle shall not travel from point to point while workers are on the platform except that inching or maneuvering at very slow speed is permissible.

(7) The area between workers on the platform and the mast shall be adequately guarded to prevent contact with chains or other shear points.

(8) All platforms shall be visually inspected daily or before each use by the person in charge of the work being performed, and shall be tested as frequently as is necessary to maintain minimum safety factors.

(9) Whenever a truck, except for high lift order picker trucks, is equipped with vertical hoisting controls elevatable with the lifting carriage or forks, the following precautions shall be taken for the protection of personnel being elevated.

(a) Provide a platform secured to the lifting carriage and/or forks.

(b) Provide means whereby personnel on the platform can shut off power to the truck.

(c) Provide such protection from falling objects as indicated necessary by the operating conditions.

#### AMENDATORY SECTION (Amending Order 90-18, filed 1/10/91, effective 2/12/91)

WAC 296-155-650 SCOPE, APPLICATION, AND DEFINITIONS APPLICABLE TO THIS PART. (1) Scope and application. This part applies to all open excavations made in the earth's surface. Excavations are defined to include trenches.

(2) Definitions applicable to this part.

(a) "Accepted engineering requirements or practices." Those requirements ((or practices that)) which are compatible with standards of practice required by a registered professional engineer.

((2)) "Actual slope." The slope of which an excavation site is excavated.

((3)) (b) "Aluminum hydraulic shoring." A preengineered shoring system comprised of aluminum hydraulic cylinders (crossbraces) used in conjunction with vertical rails (uprights) or horizontal rails (walers). Such system is designed, specifically to support the sidewalls of an excavation and prevent cave-ins.

((4)) (c) "Bell-bottom pier hole." A type of shaft or footing excavation, the bottom of which is made larger than the cross section above to form a belled shape.

(d) "Benching (benching system)." A method of protecting employees from cave-ins by excavating the sides of an excavation to form one or a series of horizontal levels or steps, usually with vertical or near-vertical surfaces between levels.

(e) "Cave-in." The separation of a mass of soil or rock material from the side of an excavation, or loss of soil from under a trench shield or support system, and its sudden movement into the excavation in quantity that it could entrap, bury, injure, or immobilize a person.

((5)) (f) "Competent person." One who can identify existing or predictable hazards in the surroundings that are unsanitary, hazardous, or dangerous to employees. Also has authorization or authority by the nature of their position to take prompt corrective measures to eliminate them. The person shall be knowledgeable in the requirements of this part.

((6)) (g) "Cross braces." The horizontal members of a shoring system installed perpendicular to the sides of the excavation, the ends of which bear against either uprights or wales.

((7)) "Distress." Soil in a condition where a cave-in is imminent or likely to occur. Distress indications may be fissures, slumping, spalling, raveling, or small amounts of materials separating from the face. The bottom may bulge or heave and the edge may sink or lower.

(8) "Equipment." Ladders, scaffolds, ramps, runways, railings, barricades, sheet piling, shoring, bracing and any such safeguards. Protective construction and devices used in affording protection to the workers engaged in excavation work.

(9) "Embankment." An artificial or man-made bank of earthen material.

((10)) (h) "Excavation." Any man-made cut, cavity, trench, or depression in the earth's surface, ((including its sides, walls, or faces,

~~formed by earth removal and producing unsupported earth conditions by reasons of the excavation. If installed forms or similar structures reduce the depth-to-width relationship, an excavation may become a trench)) formed by earth removal.~~

((11)) (i) "Faces or sides." The vertical or inclined earth surfaces formed ((because)) as a result of excavation work.

((12)) (j) "Failure." The breakage, displacement, or permanent deformation of a structural member or connection so as to reduce its structural integrity and its supportive capabilities.

((13)) (k) "Hazardous atmosphere." A atmosphere which by reason of being explosive, flammable, poisonous, corrosive, oxidizing, irritating, oxygen deficient, toxic, or otherwise harmful, may cause death, illness, or injury.

(l) "Kickouts." Accidental release or failure of a ((shore or)) cross brace.

((14)) "Maximum allowable slope." The steepest incline of an excavation face that is acceptable for the most favorable site conditions as the ratio of horizontal distance to vertical rise (H:V).

((15)) "Moving ground." Any ground, which for any reason, will not remain in its original location.

((16)) (m) "Protective system." A method of protecting employees from cave-ins, from material that could fall or roll from an excavation face or into an excavation, or from the collapse of adjacent structures. Protective systems include support systems, sloping and benching systems, shield systems, and other systems that provide the necessary protection.

((17)) (n) "Ramp." An inclined walking or working surface that is used ((as)) to gain access ((from)) to one point to another ((They may be)), and is constructed from earth or from structural materials such as steel or wood.

((18)) (o) "Registered professional engineer." A person ((that)) who is registered as a professional engineer in the state of Washington. The registered professional engineer shall comply with the Washington state department of licensing requirements, chapter 18.43 RCW.

((19)) (p) "Sheeting." The members of a shoring system that retain the earth in position and in turn are supported by other members of the shoring system((:

Tight sheeting. The use of specially edged timber planks (e.g., tongue and groove) at least three inches thick, steel sheet piling, or similar construction that when driven or paced in position provide a tight wall to resist the lateral pressure of water and to prevent the loss of backfill material.

Close sheeting. The placement of planks side-by-side allowing as little space as possible between them.

((20)) "Sheet pile." A pile, or sheeting, that may form a continuous interlocking line. A row of timber, concrete, or steel piles, driven in close contact providing a tight wall to resist the lateral pressure of water, adjacent earth, or other material)).

((21)) (q) "Shield (shield system)." A structure that ((can)) is able to withstand the forces imposed on it by a cave-in and thereby protect employees within the structure. Shields can be permanent structures or can be designed to be portable and moved along as work progresses. Additionally, shields can be either premanufactured or job-built ((according to data from the manufacture or designed by a registered professional engineer)) in accordance with WAC 296-155-657 (3)(c) or (d). Shields used in trenches are usually ((called)) referred to as "trench boxes" or "trench shields."

((22)) (r) "Shoring (shoring system)." A structure such as a metal hydraulic, mechanical, or timber shoring system that supports the sides of an excavation ((that)) and which is designed to prevent cave-ins.

((23)) (s) "Sides (—"walls," or "faces." The vertical or inclined earth surfaces formed because of excavation work:))." See "faces."

((24)) (t) "Sloping (sloping system)." A method of protecting employees from cave-ins by excavating to form sides of an excavation that are inclined away from the excavation so as to prevent cave-ins. The angle of incline required to prevent a cave-in varies with differences in such factors as the soil type, environmental conditions of exposure, and application of surcharge loads.

((25)) (u) "Stable rock." A natural solid mineral material that can be excavated with vertical sides and will remain intact while exposed. Unstable rock is considered to be stable when the rock material on the side or sides of the excavation is secured against caving-in or movement by rock bolts or by another protective system that has been designed by a registered professional engineer.

(v) "Structural ramp." A ramp built of steel or wood, usually used for vehicle access. Ramps made of soil or rock are not considered structural ramps.

(w) "Support system." A structure such as underpinning, bracing or shoring, which provides support to an adjacent structure, underground installation, or the sides of an excavation.

((267)) (x) "Tabulated data." Tables and charts approved by a registered professional engineer and used to design and construct a protective system.

(y) "Trench (trench excavation)." A narrow excavation in relation to its length made below the surface of the ground. In general, the depth is ((generally)) greater than the width, but the width of a trench (measured at the bottom) is not greater than 15 feet (4.6m). If forms or other structures are installed or constructed in an excavation so as to reduce the dimension measured from the forms or structure to the side of the excavation to 15 feet (4.6 m) or less (measured at the bottom of the excavation), the excavation is also considered to be a trench.

(z) Trench box. See "Shield."

((27)) "Trench jack." Screw or hydraulic type jacks used as cross bracing in a trench shoring system.

((28)) (aa) "Trench shield ((or "trench box))." See "shield ((in this section))."

((29)) (bb) "Uprights." The vertical members of a trench shoring system placed in contact with the earth and usually positioned so that individual members do not contact each other. Uprights placed so that individual members are closely spaced, in contact with or interconnected to each other, are often called "sheeting."

((30) "Unstable rock." Rock material on the side or sides of the excavation not secured against caving-in or movement by rock bolts or by another protective system that has been designed by a registered professional engineer.

(31) "Unstable soil." Earth material, other than running because of its nature cannot be depended upon to remain in place without extra support that would be furnished by a system of shoring.

((32)) (cc) "Wales." Horizontal members of a shoring system placed parallel to the excavation face whose sides bear against the vertical members of the shoring system or earth.

#### AMENDATORY SECTION (Amending Order 90-18, filed 1/10/91, effective 2/12/91)

WAC 296-155-655 GENERAL PROTECTION REQUIREMENTS. (1) ((Protection systems for use in excavations more than 20 feet in depth shall be designed by a registered professional engineer according to WAC 296-155-66109.

(2) Trench and excavation protection. Except in solid rock, the sides of trenches and excavations, including embankments, 4 feet or more in depth shall be shored, sheeted, braced, sloped, or supported by a means of sufficient strength to protect employees.

(3) Protection for trenches less than 4 feet. Trenches less than 4 feet in depth shall be effectively protected when there are indications that hazardous ground movement is possible.

(4) Storage of excavated material:

(a) In excavations or trenches that employees are required to enter, excavated or other material shall be stored and retained at least 2 feet away from the edge of the excavation or trench.

(b) Barriers or other effective retaining devices may be used to prevent excavated or other material from falling or rolling into the excavation or trench.

(5) Excavation and trench exits. When employees are required to be in excavations or trenches 4 feet deep or more, an adequate means of exit, such as a ladder or steps, shall be provided and located within 25 feet of lateral travel. An earth ramp is acceptable providing all following requirements are met:

(a) The stability of the earth is adequate for good footing, and

(b) The total travel distance does not exceed 25 feet, and

(c) Adequate shoring or equivalent protection is provided for the entire escape route.

(6) When sloping does not extend to the bottom of the trench, shoring shall be required to support the vertical part of the trench. The shoring shall extend above the bottom of the slope a minimum of 18 inches to prevent material from sliding or rolling into the trench.

(7) Surface encumbrances. Trees, boulders, utility poles and other surface encumbrances, located to create a hazard to employees involved in excavation or trenching work or in the vicinity during operations, shall be removed or made safe before excavation or trenching is begun or continued.

(8) Installation and removal of support:

(a) Members of support systems shall be securely connected to prevent sliding, falling, kickouts, or other predictable failure:

(b) Support systems shall be installed and removed in a way that protects employees from cave-ins, structural collapses, or from other members of the support system.

(c) Individual members of support systems shall not be subjected to loads exceeding their design.

(d) Before removal of individual members begins, additional precautions shall be taken to ensure the safety of employees installing other structural members to carry the loads imposed on the support system may be required.

(e) Removal shall begin at the bottom of the excavation. Members shall be released slowly, noting any indication of possible failure of the remaining members or possible cave-in.

(f) Backfilling shall progress together with the removal of support systems from excavations:

(9) Physical barrier protection:

(a) Adequate physical barrier protection shall be provided at all remotely located excavations or trenches.

(b) All wells, pits, shafts, etc., shall be barricaded or covered.

(c) Upon completion of exploration and similar operations, temporary wells, pits, shafts, etc., shall be completely backfilled.

(10) Inspections:

(a) Daily inspections of excavations, adjacent areas, and protective systems shall be made by a competent person for a situation that could result in cave-ins, failure of protective systems, or other hazardous conditions. An inspection shall be conducted by the competent person before the start of work and as needed throughout the shift. Inspections shall be made after every rainstorm or other hazard increasing occurrence.

(b) When the competent person finds evidence of a situation that could result in a possible cave-in, failure of protective systems or other hazardous conditions, exposed employees shall be removed from the area until the necessary precautions have been taken.

(11) Manufactured materials and equipment used for protective systems shall be used and maintained consistent with the manufacturer's recommendations:

(12)) Surface encumbrances. All surface encumbrances that are located so as to create a hazard to employees shall be removed or supported, as necessary, to safeguard employees.

(2) Underground installations.

(a) The location of utility installations, such as sewer, telephone, fuel, electric, water lines, or any other underground installations that reasonably may be expected to be encountered during excavation work, shall be located prior to opening an excavation.

(b) Utility companies or owners shall be contacted within established or customary local response times, advised of the proposed work, and asked to locate the underground utility installation prior to the start of actual excavation.

(c) When excavation operations approach the location of underground installations, the exact location of the installations shall be determined by safe and acceptable means.

(d) While the excavation is open, underground installations shall be protected, supported, or removed as necessary to safeguard employees.

(3) Access and egress.

(a) Structural ramps.

(i) Structural ramps that are used solely by employees as a means of access or egress from excavations shall be designed by a competent person. Structural ramps used for access or egress of equipment shall be designed by a competent person qualified in structural design, and shall be constructed in accordance with the design.

(ii) Ramps and runways constructed of two or more structural members shall have the structural members connected together to prevent displacement.

(iii) Structural members used for ramps and runways shall be of uniform thickness.

(iv) Cleats or other appropriate means used to connect runway structural members shall be attached to the bottom of the runway or shall be attached in a manner to prevent tripping.

(v) Structural ramps used in lieu of steps shall be provided with cleats or other surface treatments on the top surface to prevent slipping.

(b) Means of egress from trench excavations. A stairway, ladder, ramp or other safe means of egress shall be located in trench excavations that are 4 feet (1.22 m) or more in depth so as to require no more than 25 feet (7.62 m) of lateral travel for employees.

(4) Exposure to vehicular traffic. Employees exposed to public vehicular traffic shall be provided with, and shall wear, warning vests or

other suitable garments marked with or made of reflectorized or high-visibility material.

(5) Exposure to falling loads. No employee shall be permitted underneath loads handled by lifting or digging equipment. Employees shall be required to stand away from any vehicle being loaded or unloaded to avoid being struck by any spillage or falling materials. Operators may remain in the cabs of vehicles being loaded or unloaded when the vehicles are equipped, in accordance with WAC 296-155-610 (2)(g), to provide adequate protection for the operator during loading and unloading operations.

(6) Warning system for mobile equipment. When mobile equipment is operated adjacent to an excavation, or when such equipment is required to approach the edge of an excavation, and the operator does not have a clear and direct view of the edge of the excavation, a warning system shall be utilized such as barricades, hand or mechanical signals, or stop logs. If possible, the grade should be away from the excavation.

(7) Hazardous atmospheres.

(a) Testing and controls. In addition to the requirements set forth in parts B-1, C, and C-1 of this chapter (296-155 WAC) to prevent exposure to harmful levels of atmospheric contaminants and to assure acceptable atmospheric conditions, the following requirements shall apply:

(i) Where oxygen deficiency (atmospheres containing less than 19.5 percent oxygen) or a hazardous atmosphere exists or could reasonably be expected to exist, such as in excavations in landfill areas or excavations in areas where hazardous substances are stored nearby, the atmospheres in the excavation shall be tested before employees enter excavations greater than 4 feet (1.22 m) in depth.

(ii) Adequate precautions shall be taken to prevent employee exposure to atmospheres containing less than 19.5 percent oxygen and other hazardous atmospheres. These precautions include providing proper respiratory protection or ventilation in accordance with parts B-1 and C of this chapter respectively.

(iii) Adequate precaution shall be taken such as providing ventilation, to prevent employee exposure to an atmosphere containing a concentration of a flammable gas in excess of 20 percent of the lower flammable limit of the gas.

(iv) When controls are used that are intended to reduce the level of atmospheric contaminants to acceptable levels, testing shall be conducted as often as necessary to ensure that the atmosphere remains safe.

(b) Emergency rescue equipment.

(i) Emergency rescue equipment, such as breathing apparatus, a safety harness and line, or a basket stretcher, shall be readily available where hazardous atmospheric conditions exist or may reasonably be expected to develop during work in an excavation. This equipment shall be attended when in use.

(ii) Employees entering bell-bottom pier holes, or other similar deep and confined footing excavations, shall wear a harness with a lifeline securely attached to it. The lifeline shall be separate from any line used to handle materials, and shall be individually attended at all times while the employee wearing the lifeline is in the excavation.

Note: See chapter 296-62 WAC, Part M for additional requirements applicable to confined space operations.

(8) Protection from hazards associated with water accumulation.

(a) Employees shall not work in excavations in which there is accumulated water, or in excavations in which water is accumulating, unless adequate precautions have been taken to protect employees against the hazards posed by water accumulation. The precautions necessary to protect employees adequately vary with each situation, but could include special support or shield systems to protect from cave-ins, water removal to control the level of accumulating water, or use of a safety harness and lifeline.

(b) If water is controlled or prevented from accumulating by the use of water removal equipment, the water removal equipment and operations shall be monitored by a competent person to ensure proper operation.

(c) If excavation work interrupts the natural drainage of surface water (such as streams), diversion ditches, dikes, or other suitable means shall be used to prevent surface water from entering the excavation and to provide adequate drainage of the area adjacent to the excavation. Excavations subject to runoff from heavy rains will require an inspection by a competent person and compliance with subdivisions (a) and (b) of this subsection.

(9) Stability of adjacent structures.

(a) Where the stability of adjoining buildings, walls, or other structures is endangered by excavation operations, support systems such as shoring, bracing, or underpinning shall be provided to ensure ((their)) the stability of such structures for the protection of employees.

(b) Excavation below the level of the base((s)) or footing of any foundation or retaining wall that could be reasonably expected to pose a hazard to employees shall not be permitted ((unless)) except when:

(i) A support system, such as underpinning, is provided to ensure the safety of employees and the stability of the structure; or

(ii) The excavation is in stable rock; or

(iii) A registered professional engineer has ((determined)) approved the determination that the structure is sufficiently removed from the excavation ((and)) so as to be unaffected by the excavation activity; or

(iv) A registered professional engineer has ((determined)) approved the determination that such excavation work will not pose a hazard to employees.

(c) Sidewalks, pavements, and ((other)) appurtenant structure((s)) shall not be undermined unless a support system or another method of protection is provided to protect employees from the possible collapse of such structures.

~~((13)) Underground utilities. Before opening an excavation or trench, underground utilities such as sewer, telephone, fuel, electric, water line, or other installations shall be located. The appropriate utility company shall be notified and requested to identify the exact location of the underground installation.~~

~~(a) Proper supports and precautions shall be provided for existing utility installations.~~

~~(b) When electric lines are of the direct burial type, a qualified person shall make positive identification of the cable.~~

~~(c) Mechanical excavating equipment shall maintain a 2 foot clearance from the direct burial cable.~~

~~(14) When excavation operations approach the location of underground installations, the exact location of the installations shall be determined by safe and acceptable means.~~

~~(15) While the excavation is open, underground installations shall be protected, supported, or removed as necessary to safeguard employees.~~

~~(16) Water main safeguards. When existing loop water mains are running laterally within two feet of the excavation or trench wall, the valve the greatest distance from the work site shall be closed.~~

~~(a) The exact location of the open valve and the valve key shall be given to the workers before they enter the excavation or trenches.~~

~~(b) The open valve location shall be marked and clear access to the valve maintained.~~

~~(17) Protection from hazards associated with water accumulation. Employees shall not work in excavations when water is accumulating unless adequate precautions have been taken to protect employees against the hazards of water accumulation. Precautions necessary to protect employees adequately vary with each situation, but could include special support, shield systems to protect from cave-ins, or water removal to control the water level.~~

~~(18) Surface water control. Diversion ditches, dikes, adequate drainage, or other suitable means shall be used next to the excavation or trench to prevent surface water from entering.~~

~~(19) Ramps and runways.~~

~~(a) Ramps or runways used for vehicles shall be of a width of not less than four feet wider than the vehicle used and shall be provided with:~~

~~(i) Timber guards no less than 8 inches by 8 inches placed parallel to and secured to the sides of the runway or ramp; or~~

~~(ii) Berms on earthen ramps; or~~

~~(iii) Other equivalent protection.~~

~~(b) All ramps and runways shall receive daily inspection, and shall be maintained in a safe and serviceable condition.~~

~~(c) Workers shall stay off ramps and runways when vehicles are passing over them.~~

~~(d) All ruts and holes shall be filled in, humps leveled off, and the runway or ramp made smooth.~~

~~(20) Walkway and bridge requirements. Where employees or equipment cross over excavations or trenches, walkways or bridges with standard guardrails shall be provided. Such walkways or bridges shall be designed and constructed by competent persons according to accepted engineering requirements and practices.~~

~~(21) Employees next to excavations, and not directly involved in the excavation work, shall be protected by standard guardrails or equivalent means to prevent their falling.~~

~~(22) Top person. No person shall be allowed to work in a trench over 4 feet in depth unless there is a top person in constant attendance.~~

The top person shall be in addition to the equipment operator when the person in the trench is not in constant view of the equipment operator.

(23) Signalperson. Signalpersons shall be used to direct equipment when backfilling when the operator does not have a clear view of the excavation:

(24) Stop logs. When mobile equipment is used or allowed next to excavations or trenches, stop logs, or barricades shall be installed. Such devices shall not be required for equipment doing the actual excavating or backfilling operation:

(25) Dust control. Dust conditions shall be minimized by using water, or other effective means:)) (10) Protection of employees from loose rock or soil.

(a) Adequate protection shall be provided to protect employees from loose rock or soil that could pose a hazard by falling or rolling from an excavation face. Such protection shall consist of scaling to remove loose material; installation of protective barricades at intervals as necessary on the face to stop and contain falling material; or other means that provide equivalent protection.

(b) Employees shall be protected from excavated or other materials or equipment that could pose a hazard by falling or rolling into excavations. Protection shall be provided by placing and keeping such materials or equipment at least 2 feet (.61 m) from the edge of excavations, or by the use of retaining devices that are sufficient to prevent materials or equipment from falling or rolling into excavations, or by a combination of both if necessary.

(11) Inspections.

(a) Daily inspections of excavations, the adjacent areas, and protective systems shall be made by a competent person for evidence of a situation that could result in possible cave-ins, indications of failure of protective systems, hazardous atmospheres, or other hazardous conditions. An inspection shall be conducted by the competent person prior to the start of work and as needed throughout the shift. Inspections shall also be made after every rainstorm or other hazard increasing occurrence. These inspections are only required when employee exposure can be reasonably anticipated.

(b) Where the competent person finds evidence of a situation that could result in a possible cave-in, indications of failure of protective systems, hazardous atmospheres, or other hazardous conditions, exposed employees shall be removed from the hazardous area until the necessary precautions have been taken to ensure their safety.

(12) Fall protection.

(a) Where employees or equipment are required or permitted to cross over excavations, walkways or bridges with standard guardrails shall be provided.

(b) Adequate barrier physical protection shall be provided at all remotely located excavations. All wells, pits, shafts, etc., shall be barricaded or covered. Upon completion of exploration and similar operations, temporary wells, pits, shafts, etc., shall be backfilled.

AMENDATORY SECTION (Amending Order 90-18, filed 1/10/91, effective 2/12/91)

WAC 296-155-657 ((SLOPING)) REQUIREMENTS FOR PROTECTIVE SYSTEMS. (1) ((Scope and application. This section contains specifications for sloping used as a method of protecting employees working in excavations from cave-ins:

(2) Soil and rock deposits shall be classified according to WAC 296-155-664, Appendix A:

(3) Design of sloping systems. Slopes and configurations shall be selected and constructed by the employer or his designee and shall be according to the requirements of this section:

(4) Maximum allowable slope. The maximum allowable slope for soil or rock deposit shall be determined from Table 1:

(5) Actual slope:

(a) The actual slope shall not be steeper than the maximum allowable slope:

(b) The actual slope shall be less steep than the maximum allowable slope when there are signs of distress. If that situation occurs, the slope shall be cut back to an actual slope that is at least 1/2 horizontal to 1 vertical (1/2H:1V) less steep than the maximum allowable slope.

(c) When surcharge loads from stored material, equipment or traffic is present, a competent person shall determine the degree the actual slope must be reduced below the maximum allowable slope, and shall assure the reduction is achieved:

(6) Configurations. Configurations of sloping systems shall be according to Figures A-1 through D-6.

(7) Stoping systems. Employees shall not work on the faces of sloped excavations at levels above other employees unless employees at the lower levels are protected from the hazard of falling, rolling, sliding material, or equipment:

TABLE 1  
MAXIMUM ALLOWABLE SLOPES

SOIL OR ROCK TYPE	MAXIMUM ALLOWABLE SLOPES (H:V) <sup>(1)</sup> FOR EXCAVATIONS LESS THAN 20 FEET DEEP <sup>(2)</sup>
STABLE ROCK TYPE A TYPE B TYPE C	VERTICAL (90°) 3/4:1 (53°) 1:1 (45°) 1 1/2:1 (34°)

NOTES:

- [1] Numbers shown in parentheses next to maximum allowable slopes are angles expressed in degrees from the horizontal. Angles have been rounded off.
- [2] Sloping for excavations greater than 20 feet deep shall be designed by a registered professional engineer.

Figure A-1

Slope Configuration for Type A Soil

(All Slopes stated below are in the horizontal to vertical ratio)

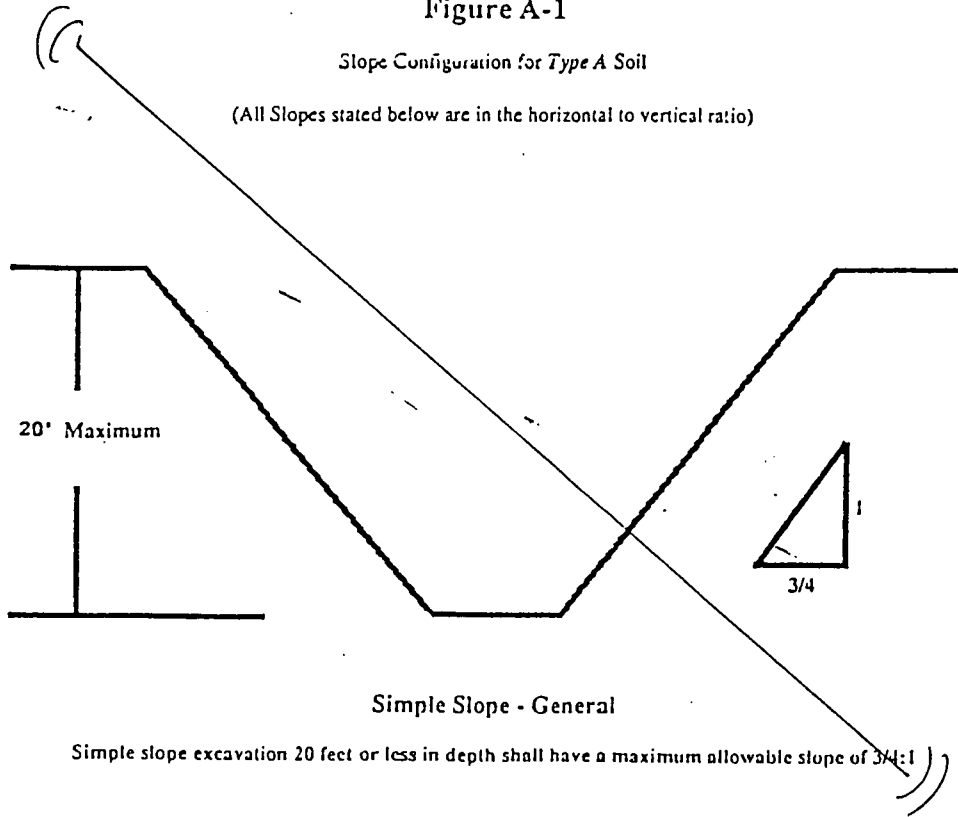
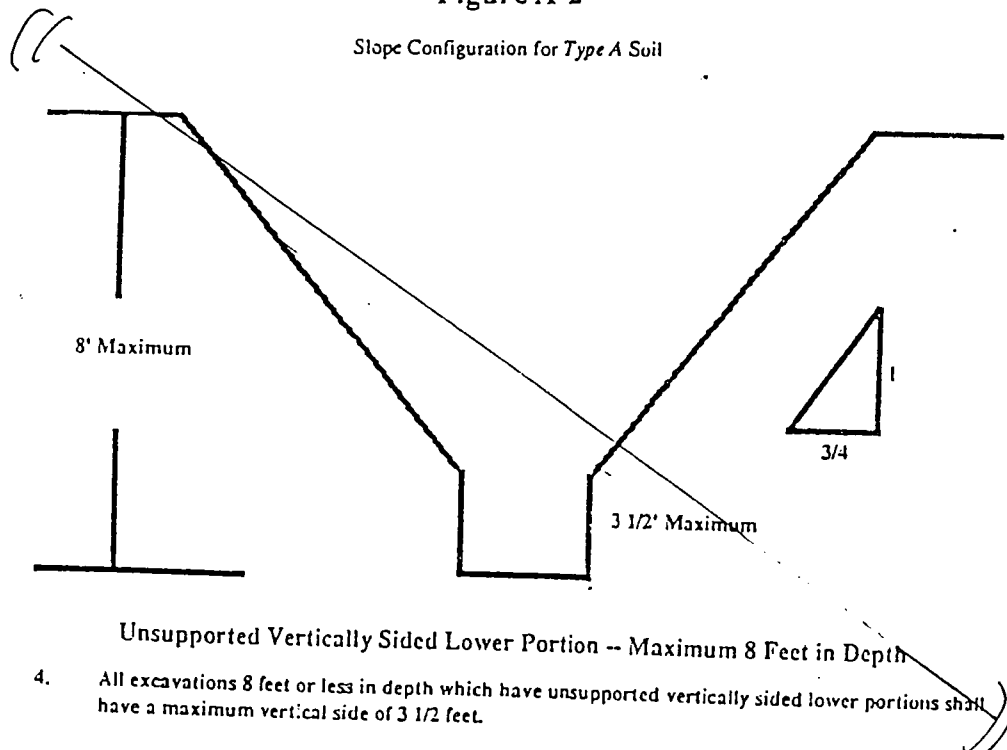

Figure A-2

Slope Configuration for Type A Soil



4. All excavations 8 feet or less in depth which have unsupported vertically sided lower portions shall have a maximum vertical side of 3 1/2 feet.



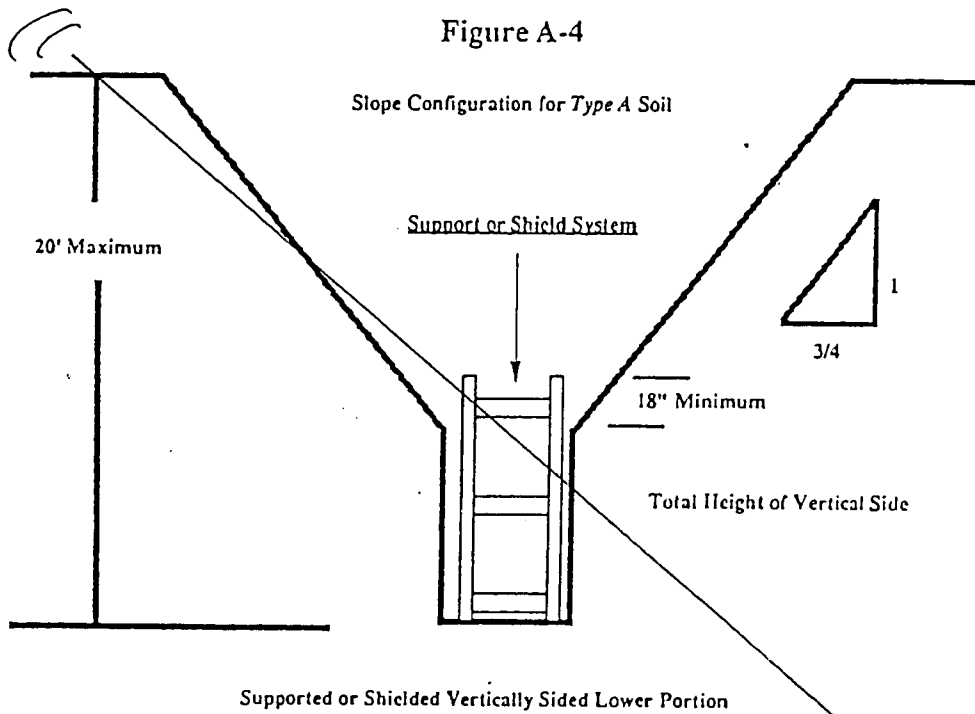
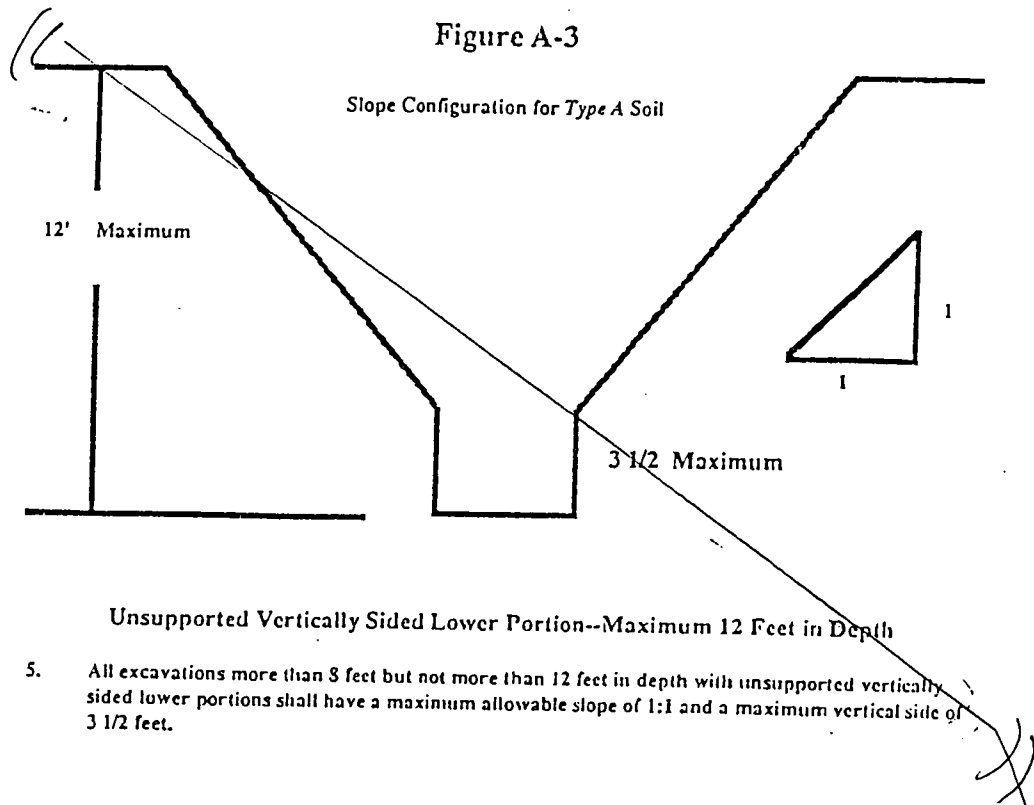

Excavations 20 feet or less in depth which have vertically sided lower portions that are supported or shielded shall have a maximum allowable slope of 3/4:1. The support or shield system must extend at least 18 inches above the top of the vertical side.

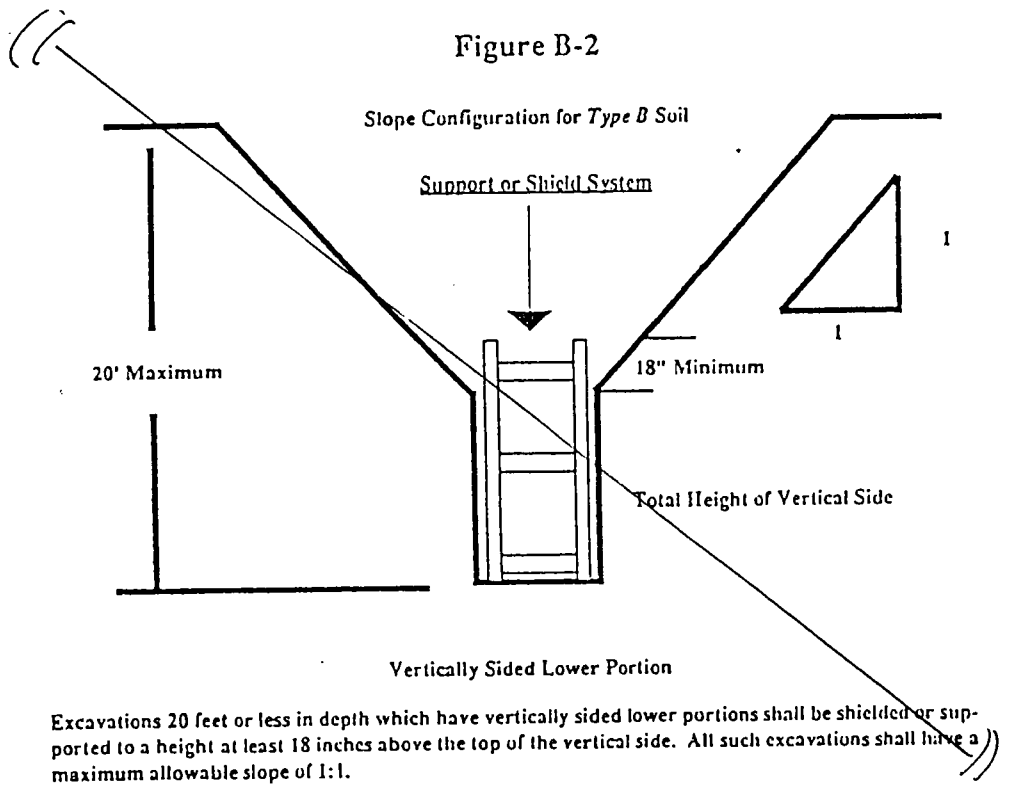
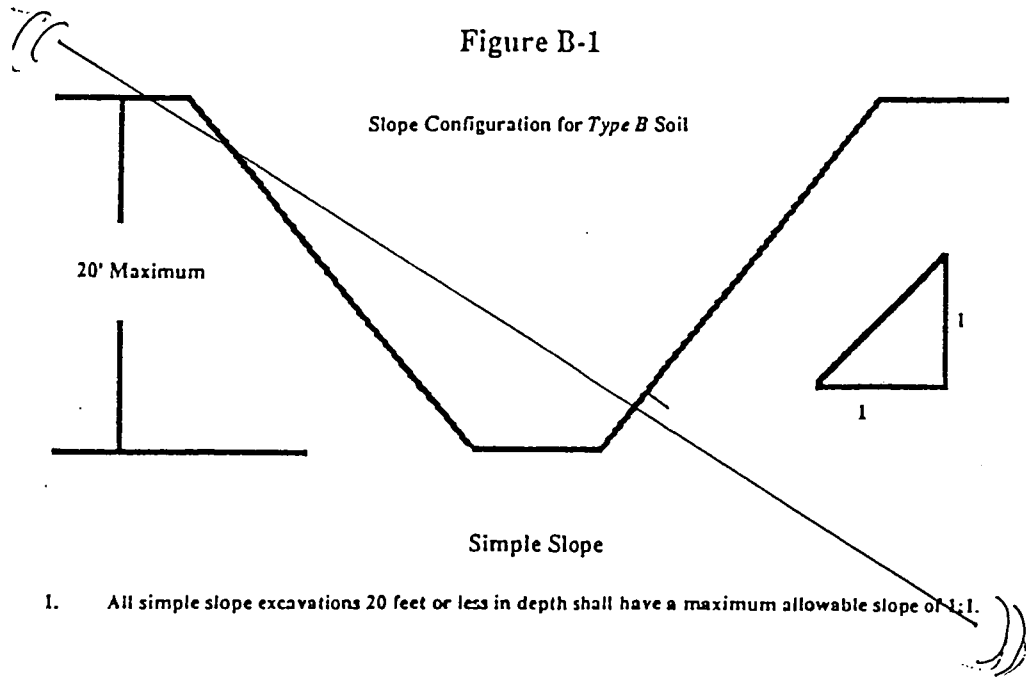
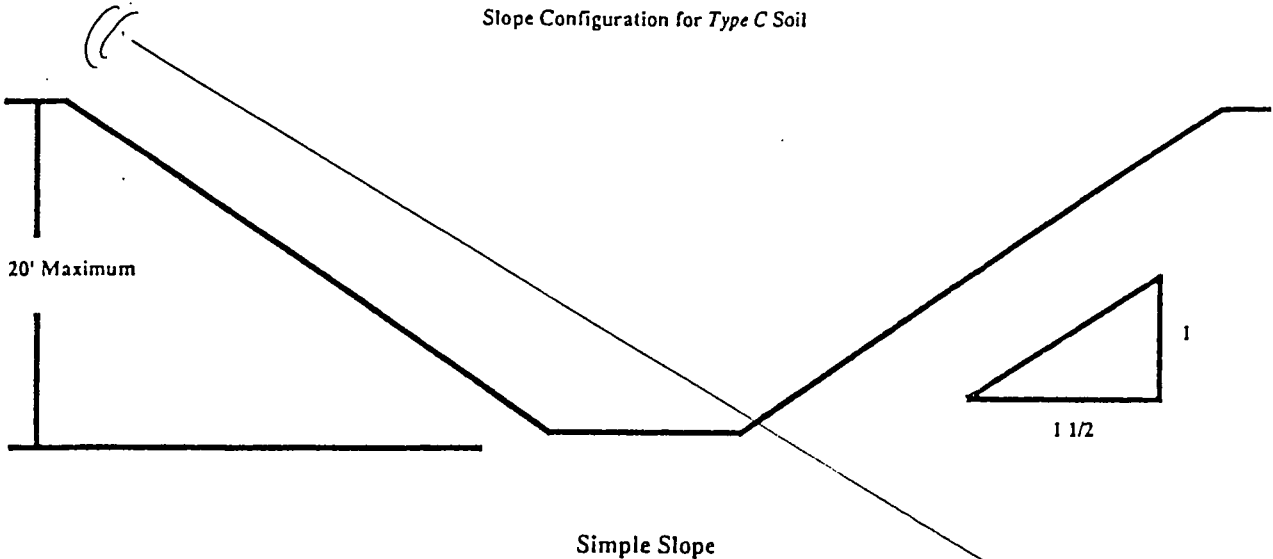

Figure C-1

Slope Configuration for Type C Soil



1. Simple slope excavations 20 feet or less in depth shall have a maximum allowable slope of 1 1/2:1.

Figure C-2

Slope Configuration for Type C Soil

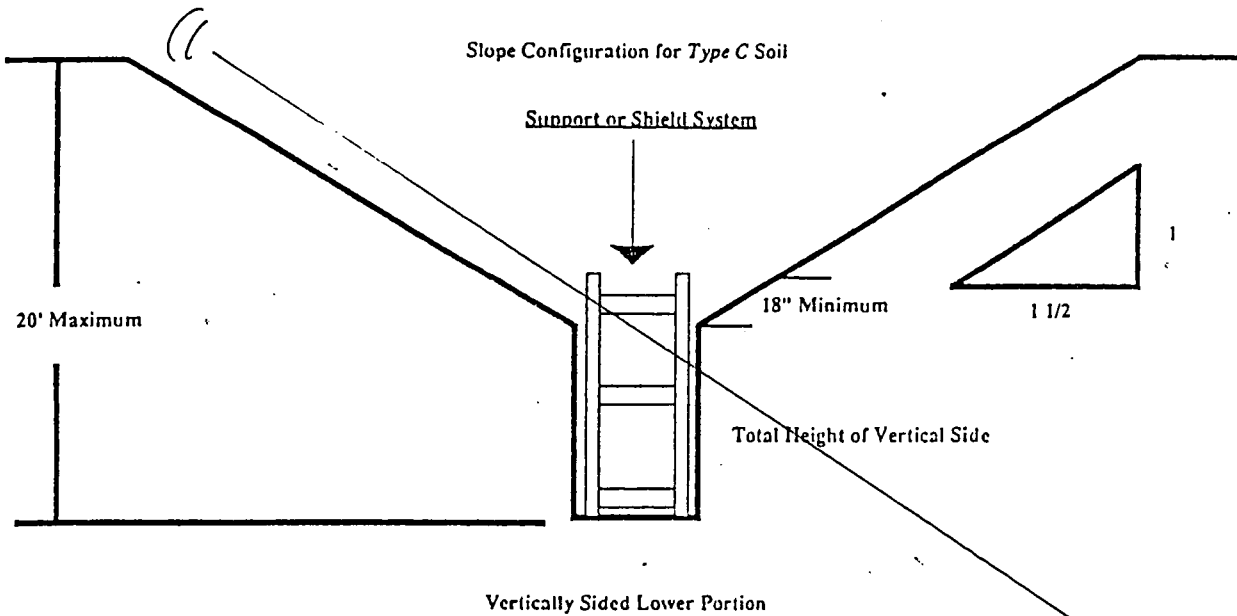

2. Excavations 20 feet or less in depth which have vertically sided lower portions shall be shielded or supported to a height at least 18 inches above the top of the vertical side. All such excavations shall have a maximum allowable slope of 1 1/2:1.

EXCAVATIONS MADE IN LAYERED SOILS

Excavations 20 feet or less in depth made in layered soils shall have a maximum allowable slope for each layer as set forth below:

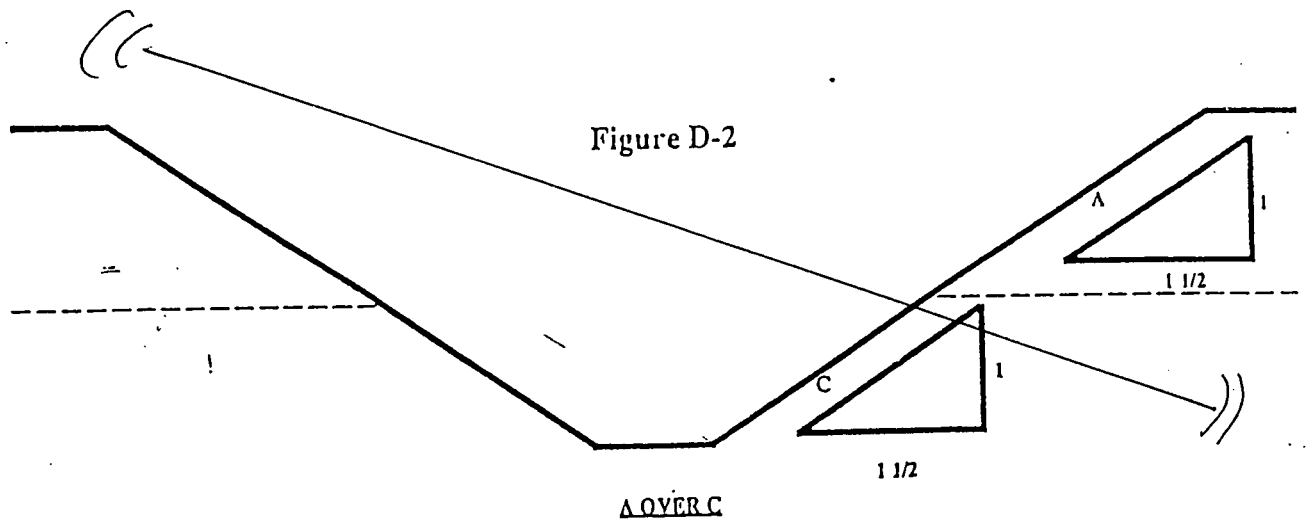
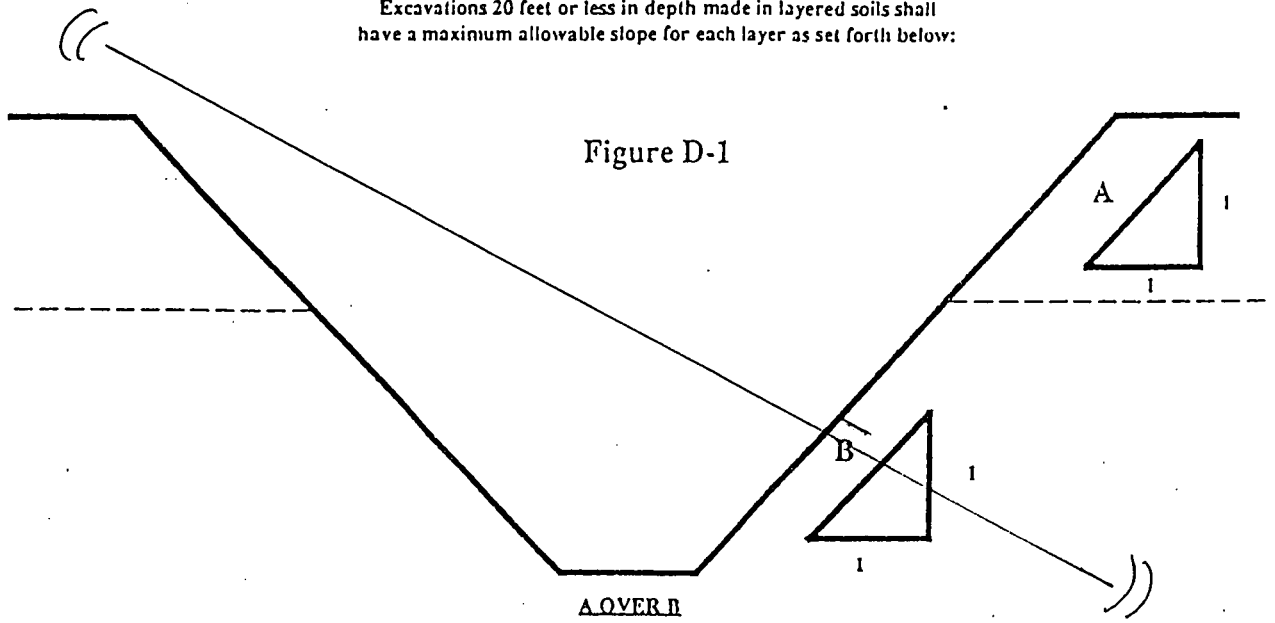

Figure D-3

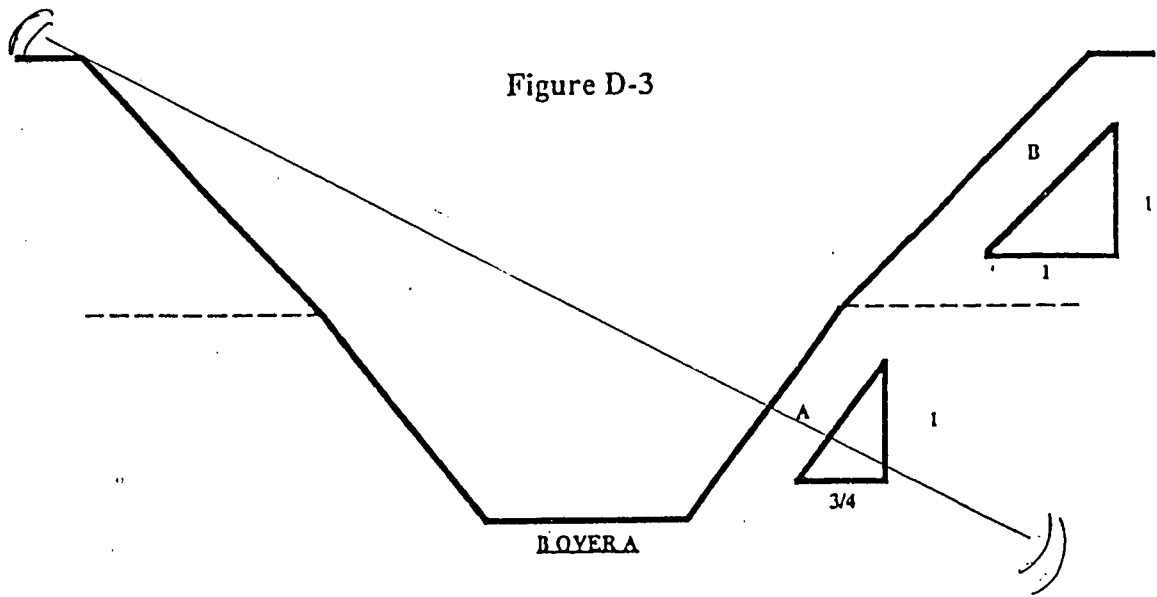

Figure D-4

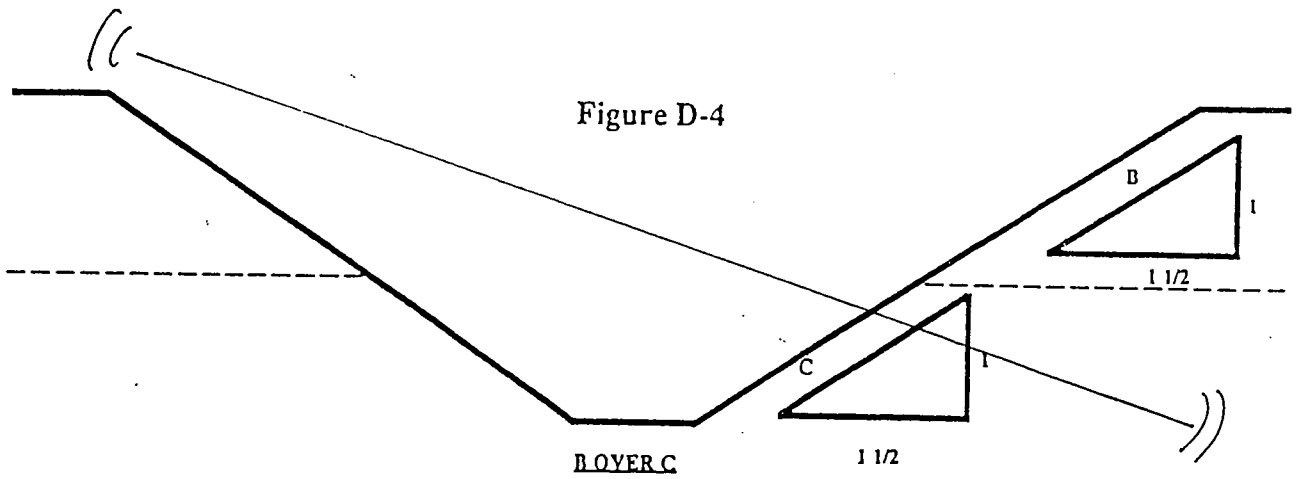

Figure D-5

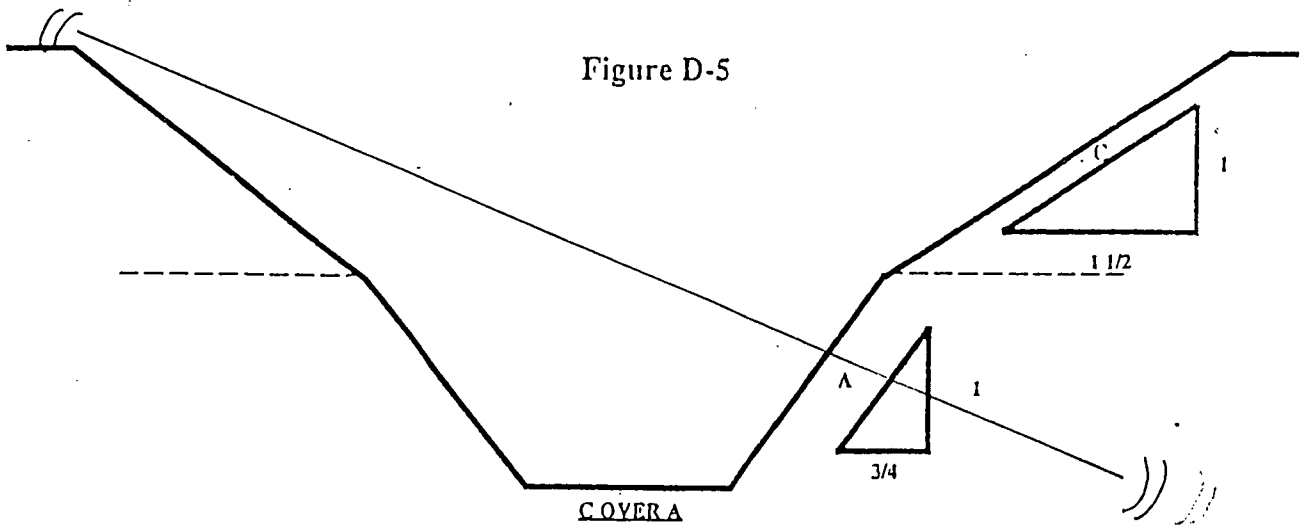
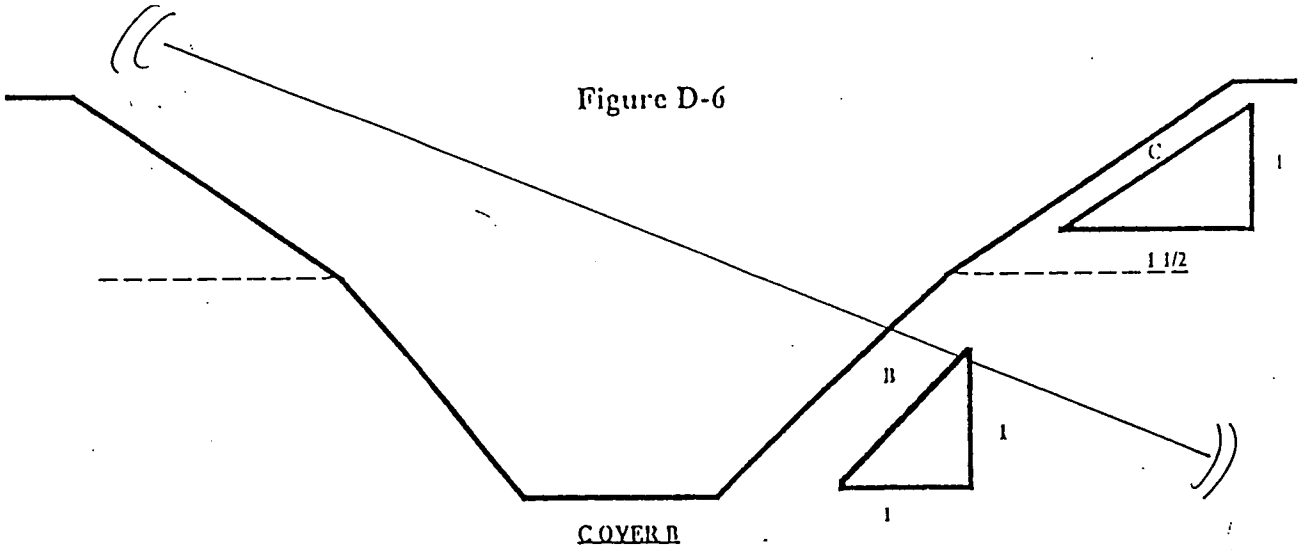

Figure D-6



Protection of employees in excavations.

(a) Each employee in an excavation shall be protected from cave-ins by an adequate protective system designed in accordance with subsections (2) or (3) of this section except when:

(i) Excavations are made entirely in stable rock; or

(ii) Excavations are less than 4 feet (1.52m) in depth and examination of the ground by a competent person provides no indication of a potential cave-in.

(b) Protective systems shall have the capacity to resist without failure all loads that are intended or could reasonably be expected to be applied or transmitted to the system.

(2) Design of sloping and benching systems. The slopes and configurations of sloping and benching systems shall be selected and constructed by the employer or employer's designee and shall be in accordance with the requirements of subdivision (a); or, in the alternative, subdivision (b); or, in the alternative, subdivision (c); or, in the alternative, subdivision (d), as follows:

(a) Option 1—Allowable configurations and slopes.

(i) Excavations shall be sloped at an angle not steeper than one and one-half horizontal to one vertical (34 degrees measured from the horizontal), unless the employer uses one of the other options listed below.

(ii) Slopes specified in item (i) of this subdivision, shall be excavated to form configurations that are in accordance with the slopes shown for Type C soil in Appendix B to this part.

(b) Option 2—Determination of slopes and configurations using Appendices A and B. Maximum allowable slopes, and allowable configurations for sloping and benching systems, shall be determined in accordance with the conditions and requirements set forth in appendices A and B to this part.

(c) Option 3—Designs using other tabulated data.

(i) Designs of sloping or benching systems shall be selected from and be in accordance with tabulated data, such as tables and charts.

(ii) The tabulated data shall be in written form and shall include all of the following:

(A) Identification of the parameters that affect the selection of a sloping or benching system drawn from such data;

(B) Identification of the limits of use of the data, to include the magnitude and configuration of slopes determined to be safe;

(C) Explanatory information as may be necessary to aid the user in making a correct selection of a protective system from the data.

(iii) At least one copy of the tabulated data which identifies the registered professional engineer who approved the data, shall be maintained at the jobsite during construction of the protective system. After that time the data may be stored off the jobsite, but a copy of the data shall be made available to the director upon request.

(d) Option 4—Design by a registered professional engineer.

(i) Sloping and benching systems not utilizing Option 1 or Option 2 or Option 3 under subsection (2) of this section shall be approved by a registered professional engineer.

(ii) Designs shall be in written form and shall include at least the following:

(A) The magnitude of the slopes that were determined to be safe for the particular project;

(B) The configurations that were determined to be safe for the particular project; and

(C) The identity of the registered professional engineer approving the design.

(iii) At least one copy of the design shall be maintained at the jobsite while the slope is being constructed. After that time the design need not be at the jobsite, but a copy shall be made available to the director upon request.

(3) Design of support systems, shield systems, and other protective systems. Designs of support systems, shield systems, and other protective systems shall be selected and constructed by the employer or employer's designee and shall be in accordance with the requirements of subdivision (a); or, in the alternative, subdivision (b); or, in the alternative, subdivision (c); or, in the alternative, subdivision (d) as follows:

(a) Option 1—Designs using appendices A, C, and D. Designs for timber shoring in trenches shall be determined in accordance with the conditions and requirements set forth in appendices A and C to this part. Designs for aluminum hydraulic shoring shall be in accordance with subdivision (b) of this subsection, but if manufacturer's tabulated data cannot be utilized, designs shall be in accordance with appendix D.

(b) Option 2—Designs using manufacturer's tabulated data.

(i) Design of support systems, shield systems, or other protective systems that are drawn from manufacturer's tabulated data shall be in accordance with all specifications, recommendations, and limitations issued or made by the manufacturer.

(ii) Deviation from the specifications, recommendations, and limitations issued or made by the manufacturer shall only be allowed after the manufacturer issues specific written approval.

(iii) Manufacturer's specifications, recommendations, and limitations, and manufacturer's approval to deviate from the specifications, recommendations, and limitations shall be in written form at the jobsite during construction of the protective system. After that time this data may be stored off the jobsite, but a copy shall be made available to the director upon request.

(c) Option 3—Designs using other tabulated data.

(i) Designs of support systems, shield systems, or other protective systems shall be selected from and be in accordance with tabulated data, such as tables and charts.

(ii) The tabulated data shall be in written form and include all of the following:

(A) Identification of the parameters that affect the selection of a protective system drawn from such data;

(B) Identification of the limits of use of the data;

(C) Explanatory information as may be necessary to aid the user in making a correct selection of a protective system from the data.

(iii) At least one copy of the tabulated data, which identifies the registered professional engineer who approved the data, shall be maintained at the jobsite during construction of the protective system. After that time the data may be stored off the jobsite, but a copy of the data shall be made available to the director upon request.

(d) Option 4—Design by a registered professional engineer.

(i) Support systems, shield systems, and other protective systems not utilizing Option 1, Option 2 or Option 3, above, shall be approved by a registered professional engineer.

(ii) Designs shall be in written form and shall include the following:

(A) A plan indicating the sizes, types, and configurations of the materials to be used in the protective system; and

(B) The identity of the registered professional engineer approving the design.

(iii) At least one copy of the design shall be maintained at the jobsite during construction of the protective system. After that time, the design may be stored off the jobsite, but a copy of the design shall be made available to the director upon request.

(4) Materials and equipment.

(a) Materials and equipment used for protective systems shall be free from damage or defects that might impair their proper function.

(b) Manufactured materials and equipment used for protective systems shall be used and maintained in a manner that is consistent with the recommendations of the manufacturer, and in a manner that will prevent employee exposure to hazards.

(c) When material or equipment that is used for protective systems is damaged, a competent person shall examine the material or equipment and evaluate its suitability for continued use. If the competent person cannot assure the material or equipment is able to support the intended loads or is otherwise suitable for safe use, then such material or equipment shall be removed from service, and shall be evaluated and approved by a registered professional engineer before being returned to service.

(5) Installation and removal of support.

(a) General.

(i) Members of support systems shall be securely connected together to prevent sliding, falling, kickouts, or other predictable failure.

(ii) Support systems shall be installed and removed in a manner that protects employees from cave-ins, structural collapses, or from being struck by members of the support system.

(iii) Individual members of support systems shall not be subjected to loads exceeding those which those members were designed to withstand.

(iv) Before temporary removal of individual members begins, additional precautions shall be taken to ensure the safety of employees, such as installing other structural members to carry the loads imposed on the support system.

(v) Removal shall begin at, and progress from, the bottom of the excavation. Members shall be released slowly so as to note any indication of possible failure of the remaining members of the structure or possible cave-in of the sides of the excavation.

(vi) Backfilling shall progress together with the removal of support systems from excavations.

(b) Additional requirements for support systems for trench excavations.

(i) Excavation of material to a level no greater than 2 feet (.61 m) below the bottom of the members of a support system shall be permitted, but only if the system is designed to resist the forces calculated for the full depth of the trench, and there are no indications while the trench is open of a possible loss of soil from behind or below the bottom of the support system.

(ii) Installation of a support system shall be closely coordinated with the excavation of trenches.

(6) Sloping and benching systems. Employees shall not be permitted to work on the faces of sloped or benched excavations at levels above other employees except when employees at the lower levels are adequately protected from the hazard of falling, rolling, or sliding material or equipment.

(7) Shield systems.(a) General.

(i) Shield systems shall not be subjected to loads exceeding those which the system was designed to withstand.

(ii) Shields shall be installed in a manner to restrict lateral or other hazardous movement of the shield in the event of the application of sudden lateral loads.

(iii) Employees shall be protected from the hazard of cave-ins when entering or exiting the areas protected by shields.

(iv) Employees shall not be allowed in shields when shields are being installed, removed, or moved vertically.

(b) Additional requirement for shield systems used in trench excavations. Excavations of earth material to a level not greater than 2 feet (.61 m) below the bottom of a shield shall be permitted, but only if the shield is designed to resist the forces calculated for the full depth of the trench, and there are no indications while the trench is open of a possible loss of soil from behind or below the bottom of the shield.

AMENDATORY SECTION (Amending Order 90-18, filed 1/10/91, effective 2/12/91)

WAC 296-155-66103 ((~~TIMBER SHORING FOR TRENCHES~~)) RESERVED. ((~~1~~)) Scope and application. This section shall be used when designing a timber shoring protective system. Shoring systems for use in situations that are not covered by this section shall be designed as specified in other sections of this part.

(2) Soil and rock deposits shall be classified according to WAC 296-166-664, Appendix A.

(3) Design of support systems. Support systems, shield systems, and other protective systems shall be selected and constructed by the employer or his designee.

(4) The support system shall extend to the bottom of the trench or excavation. The system shall be designed to resist the forces calculated for the full depth of the trench.

(5) Installation of a support system shall be closely coordinated with the excavation of trenches.

(6) When voids form in the sides or face of the trench, after placement of shoring or bracing, they shall be promptly filled with compacted material and blocking. Voids are filled to uniformly distribute the load onto the shoring or bracing.

(7) When any of the following conditions are present, the members specified in the tables are not considered adequate. Either an alternate timber shoring system must be designed or another type of protective system designed in accordance with WAC 296-155-66109.

(a) When loads imposed by structures or by stored material adjacent to the trench weigh in excess of the load imposed by a two-foot soil surcharge. (The term "adjacent" as used here means the area within a horizontal distance from the edge of the trench equal to the depth of the trench.)

(b) When vertical loads imposed on crossbraces exceed a 240-pound gravity load distributed on a one-foot section of the center of the crossbrace.

(c) When surcharge loads are present from equipment weighing more than 20,000 pounds.

(d) When only the lower portion of a trench is shored and the upper portion of the trench is sloped unless:

(i) The sloped portion shall be at an angle of at least 3 horizontal to 1 vertical; or

(ii) The shoring members shall be selected from the tables for the total depth of the trench.

(8) Protective systems:

(a) The timber trench shoring system used in trenches or excavations shall be according to tables 1 through 3.

(b) When conditions are saturated or submerged tight sheeting shall be used:

(c) All spacing shall be measured center to center.

(d) Walers shall be installed with greater dimension horizontal.

(e) Trench jacks may be used instead of, or in combination with timber crossbraces.

(f) Placement of crossbraces. When the vertical spacing of crossbraces is 4 feet, place the top crossbrace no more than 2 feet below the top of the trench. When the vertical spacing of crossbraces is 5 feet, place the top crossbrace no more than 2.5 feet below the top of the trench.

(9) Plywood used shall be 1.125 inch thick softwood or 0.75 inch thick, 14 ply, arctic white birch (Finland form). Plywood is not intended as a structural member, but only for preservation of local raveling (sloughing of the trench face) between shores.



TABLE 1  
TIMBER TRENCH SHORING - MINIMUM TIMBER REQUIREMENTS\*

SOIL TYPE A  $P_s = 25 X H + 72$  psf (2 ft. Surcharge)

DEPTH OF TRENCH (FEET)	NOMINAL SIZE AND SPACING OF MEMBERS**													
	HORIZ. SPAC-ING (FEET)	CROSS BRACES					VERT. SPAC-ING (FEET)	WALES		UPRIGHTS				
		WIDTH OF TRENCH (FEET)						SIZE (IN)	VERT. SPAC-ING (FEET)	MAXIMUM ALLOWABLE HORIZONTAL SPACING (FEET)				
	Up To 4	Up To 6	Up To 9	Up To 12	Up To 15				CLOSE	4	5	6	8	
4 TO 10	Up to 6	4X4	4X4	4X4	4X4	4X6	4	Not Required	Not Required				4X4	
	Up to 8	4X4	4X4	4X4	4X4	4X6	4	Not Required	Not Required					4X4
	Up to 10	4X6	4X6	4X6	4X6	4X6	4	8X8	4			4X6		
10 TO 15	Up to 6	4X4	4X4	4X4	4X4	4X6	4	Not Required	Not Required				4X10	
	Up to 8	4X6	4X6	4X6	4X6	4X6	4	6X8	4		4X6			
	Up to 10	4X6	4X6	4X6	4X6	4X6	4	8X8	4			4X8		
15 TO 20	Up to 6	4X6	4X6	4X6	4X6	4X6	4	8X10	4		4X6		4X10	
	Up to 8	4X6	4X6	4X6	4X6	4X6	4	6X8	4	3X6				
	Up to 10	4X6	4X6	4X6	4X6	4X6	4	8X8	4	3X6	4X12			
20 TO 25	Up to 6	4X6	4X6	4X6	4X6	4X6	4	8X10	4	3X6	4X12			
	Up to 8	4X6	4X6	4X6	4X6	4X6	4	8X8	4	3X6	4X12			
	Up to 10	4X6	4X6	4X6	4X6	4X6	4	8X10	4	3X6	4X12			
OVER 20	Protective systems for trenches over 20 feet shall be designed by a registered professional engineer. See WAC 296-155-655(1)													

\* Douglas Fir or Equivalent with a Bending Strength not less than 1500 psi.  
\*\* Manufactured Members of Equivalent Strength may be Substituted for Wood.

TABLE 2  
TIMBER TRENCH SHORING - MINIMUM TIMBER REQUIREMENTS\*

SOIL TYPE B  $P_s = 45 X H + 72$  psf (2 ft. Surcharge)

DEPTH OF TRENCH (FEET)	NOMINAL SIZE AND SPACING OF MEMBERS**													
	HORIZ. SPAC-ING (FEET)	CROSS BRACES					VERT. SPAC-ING (FEET)	WALES		UPRIGHTS				
		WIDTH OF TRENCH (FEET)						SIZE (IN)	VERT. SPAC-ING (FEET)	MAXIMUM ALLOWABLE HORIZONTAL SPACING (FEET)				
	Up To 4	Up To 6	Up To 9	Up To 12	Up To 15				CLOSE	2	3	4	6	
4 TO 10	Up to 6	4X6	4X6	4X6	4X6	4X6	5	6X8	5			3X12	4X4	4X12
	Up to 8	4X6	4X6	4X6	4X6	4X6	5	8X8	5		3X4		4X8	
	Up to 10	4X6	4X6	4X6	4X6	4X6	5	8X10	5			4X8		
10 TO 15	Up to 6	4X6	4X6	4X6	4X8	4X8	5	8X8	5	3X6	4X10			
	Up to 8	4X8	4X8	4X8	4X8	4X8	5	10X10	5	3X4	4X10			
	Up to 10	4X8	4X8	4X8	4X8	4X8	5	10X12	5	3X6	4X10			
15 TO 20	Up to 6	4X8	4X8	4X8	4X8	4X8	5	8X10	5	4X4				
	Up to 8	4X8	4X8	4X8	4X8	4X8	5	10X12	5	4X4				
	Up to 10	4X8	4X6	4X8	4X8	4X6	5	12X12	5	4X6				
OVER 20	Protective systems for trenches over 20 feet shall be designed by a registered professional engineer. See WAC 296-155-655(1)													

\* Douglas Fir or Equivalent with a Bending Strength not less than 1500 psi.  
\*\* Manufactured Members of Equivalent Strength may be Substituted for Wood.

TABLE 1  
TIMBER TRENCH SHORING - MINIMUM TIMBER REQUIREMENTS\*

SOIL TYPE C  $P_s = 80 X H + 72$  psf (2 ft. Surcharge)

DEPTH OF TRENCH (FEET)	NOMINAL SIZE AND SPACING OF MEMBERS**												
	HORIZ. SPACING (FEET)	CROSS BRACES					VERT. SPACING (FEET)	WALES		UPRIGITS			
		Up To 4	Up To 6	Up To 9	Up To 12	Up To 15		SIZE (IN)	VERT. SPACING (FEET)	MAXIMUM ALLOWABLE HORIZONTAL SPACING (FEET)			
									CLOSE	1	2	3	
4 TO 10	Up To 4	4X4	4X4	4X4	4X4	4X8	5	4X8	5	3X8			
	Up To 6	4X4	4X4	4X4	4X8	4X8	5	10X10	5	3X8			
	Up To 9	4X4	4X4	4X8	4X8	4X8	5	10X12	5	3X8			
	Up To 10	4X4	4X4	4X8	4X8	4X8	5	10X12	5	3X8			
10 TO 15	Up To 6	4X4	4X4	4X8	4X8	4X8	5	10X10	5	4X6			
	Up To 9	4X4	4X4	4X8	4X8	4X8	5	12X12	5	4X6			
	Up To 10	4X4	4X4	4X8	4X8	4X8	5	12X12	5	4X6			
	Up To 15	4X4	4X4	4X8	4X10	4X10	5	10X12	5	4X6			
15 TO 20	Up To 6	4X4	4X4	4X8	4X10	4X10	5	10X12	5	4X6			
	Up To 9	4X4	4X4	4X8	4X10	4X10	5	10X12	5	4X6			
	Up To 10	4X4	4X4	4X8	4X10	4X10	5	10X12	5	4X6			
	Up To 15	4X4	4X4	4X8	4X10	4X10	5	10X12	5	4X6			
OVER 20	Protective systems for trenches over 20 feet shall be designed by a registered professional engineer. See WAC 296-155-455(1)												

\* Douglas Fir or Equivalent with a Bending Strength not less than 1500 psi.  
\*\* Manufactured Members of Equivalent Strength may be Substituted for Wood.

**AMENDATORY SECTION** (Amending Order 90-18, filed 1/10/91, effective 2/12/91)

WAC 296-155-66105 ((ALUMINUM HYDRAULIC SHORING FOR TRENCHES)) RESERVED. ((†) Scope. This section shall be used for the design of an aluminum hydraulic protective system when the trench does not exceed 20 feet in depth.

(2) Soil and rock deposits shall be classified according to WAC 296-155-664 Appendix A.

(3) Tables D-1 through D-4 shall be used for an aluminum hydraulic shoring system:

(a) All spacing indicated shall be measured center to center.

(b) Vertical shoring rails shall have a minimum section modulus of 0.40 inch.

(c) When vertical shores are used, there must be a minimum of 3 shores spaced equally, horizontally, in a group:

(d) Plywood shall be 1.125 inch thick softwood or 0.75 inch thick, 14 ply, arctic white birch (Finland form). Plywood is not intended as a structural member, only for prevention of local raveling (sloughing of the trench face) between shores.

(4) When any of the following conditions are present, the members specified in the tables are not considered adequate. Here the aluminum hydraulic shoring system or other type of protective system shall be designed using manufacturer's data or designed according to WAC 296-155-66109:

(a) When vertical loads imposed on crossbraces exceed a 100-pound gravity load distributed on a one-foot section of the center of the hydraulic cylinder.

(b) When surcharge loads are present from equipment weighing more than 20,000 pounds:

(c) When only the lower portion of a trench is shored and the upper portion of the trench is sloped:

(i) The sloped portion shall be at an angle of at least 3 horizontal to 1 vertical; or

(ii) The shoring members shall be selected from the tables for the total depth of the trench.

(5) Hydraulic cylinders capacities:

(a) Two-inch cylinders shall be a minimum 2-inch inside diameter with a safe working capacity of not less than 18,000 pounds axial compressive load at maximum extension. Maximum extension is to include full range of cylinder extensions as recommended by product manufacturer.

(b) Three-inch cylinders shall be a minimum 3-inch inside diameter with a safe work capacity of not less than 30,000 pounds axial compressive load at maximum extension. Maximum extension is to include full range of cylinder extensions as recommended by product manufacturer.

(6) Shield systems:

(a) Shield systems shall be designed by a registered professional engineer.

(b) Shield systems shall be designed to resist the forces calculated for the full depth of the trench.

(c) Plans and calculations prepared by the registered professional engineer shall be made available at the work site to the director or authorized representative.

(d) The employer shall establish a permanent means of identifying the shield system.

(e) Shield systems shall not be subjected to loads exceeding those the system is designed to withstand.

(f) Shields shall be installed to restrict lateral or other hazardous movements if sudden lateral loads are applied.

(g) Employees shall be protected from the hazard of cave-ins when entering or exiting the areas protected by shields.

(h) Employees shall not be allowed in shields when shields are being installed, removed, or moved vertically.

(i) Shields shall extend to the bottom of the trench.

TABLE D - 1  
ALUMINUM HYDRAULIC SHORING  
VERTICAL SHORES  
FOR SOIL TYPE A

Depth of Trench (Feet)	Maximum Horizontal Spacing (Feet)	Maximum Vertical Spacing (Feet)	Hydraulic Cylinders		
			Width of Trench (Feet)		
			Up to 8	Over 8 Up to 12	Over 12 Up to 15
Over 4 Up to 10	8	4	2 INCH DIAMETER	2 INCH DIAMETER See NOTE (1)	3 INCH DIAMETER
Over 10 Up to 15	8				
Over 15 Up to 20	7				
Over 20	Protective systems for trenches over 20 feet shall be designed by a registered professional engineer. See WAC 296-155-655(1)				

NOTE (1): 2 inch diameter cylinders, at this width, shall have structural steel tube (3.5 X 3.5 X 0.1875) oversleeves, or structural oversleeves of manufacturer's specification, extending the full, collapsed length.

TABLE D - 2  
ALUMINUM HYDRAULIC SHORING  
VERTICAL SHORES  
FOR SOIL TYPE B

Depth of Trench (Feet)	Maximum Horizontal Spacing (Feet)	Maximum Vertical Spacing (Feet)	Hydraulic Cylinders		
			Width of Trench (Feet)		
			Up to 8	Over 8 Up to 12	Over 12 Up to 15
Over 4 Up to 10	8	4	2 INCH DIAMETER	2 INCH DIAMETER See NOTE (1)	3 INCH DIAMETER
Over 10 Up to 15	6.5				
Over 15 Up to 20	5.5				
Over 20	Protective systems for trenches over 20 feet shall be designed by a registered professional engineer. See WAC 296-155-655(1)				

NOTE (1): 2 inch diameter cylinders, at this width, shall have structural steel tube (3.5 X 3.5 X 0.1875) oversleeves, or structural oversleeves of manufacturer's specification, extending the full, collapsed length.

TABLE D-3  
ALUMINUM HYDRAULIC SHORING  
WALER SYSTEMS  
FOR SOIL TYPE B

Depth of Trench (Feet)	Wales		Hydraulic Cylinders						Timber Uprights		
	Vertical Spacing (Feet)	Section* Modulus (in <sup>4</sup> )	Width of Trench (Feet)						Solid Sheet	2 Feet	3 Feet
			Up to 8		Over 8 - Up to 12		Over 12 - Up to 15				
Over 4 Up to 10	4	3.5	8.0	2 IN	8.0	2 IN	8.0	3 IN	---	---	3 X 12
		7.0	9.0	2 IN	9.0	2 IN	9.0	3 IN			
		14.0	12.0	3 IN	12.0	3 IN	12.0	3 IN			
Over 10 Up to 15	4	3.5	6.0	2 IN	6.0	2 IN	6.0	3 IN	---	3 X 12	---
		7.0	8.0	3 IN	8.0	3 IN	8.0	3 IN			
		14.0	10.0	3 IN	10.0	3 IN	10.0	3 IN			
Over 15 Up to 20	4	3.5	5.5	2 IN	5.5	2 IN	5.5	3 IN	3 X 12	---	---
		7.0	6.0	3 IN	6.0	3 IN	6.0	3 IN			
		14.0	9.0	3 IN	9.0	3 IN	9.0	3 IN			
Over 20	Protective systems for trenches over 20 feet shall be designed by a registered professional engineer. See WAC 296-155-655(1)										

NOTE (1): 2 inch diameter cylinders, at this width, shall have structural steel tube (3.5 X 3.5 X 0.1875) oversleeves, or structural oversleeves of manufacturer's specification, extending the full, collapsed length.

\*Consult product manufacturer and/or qualified engineer for Section Modulus of available wales.

TABLE D-4  
ALUMINUM HYDRAULIC SHORING  
WALER SYSTEMS  
FOR SOIL TYPE C

Depth of Trench (Feet)	Wales		Hydraulic Cylinders						Timber Uprights		
	Vertical Spacing (Feet)	Section* Modulus (in <sup>4</sup> )	Width of Trench (Feet)						Solid Sheet	2 Feet	3 Feet
			Up to 8		Over 8 - Up to 12		Over 12 - Up to 15				
Over 4 Up to 10	4	3.5	6.0	2 IN	6.0	2 IN	6.0	3 IN	3 X 12	---	---
		7.0	6.5	2 IN	6.5	2 IN	6.5	3 IN			
		14.0	10.0	3 IN	10.0	3 IN	10.0	3 IN			
Over 10 Up to 15	4	3.5	4.0	2 IN	4.0	2 IN	4.0	3 IN	3 X 12	---	---
		7.0	5.5	3 IN	5.5	3 IN	5.5	3 IN			
		14.0	8.0	3 IN	8.0	3 IN	8.0	3 IN			
Over 15 Up to 20	4	3.5	3.5	2 IN	3.5	2 IN	3.5	3 IN	3 X 12	---	---
		7.0	5.0	3 IN	5.0	3 IN	5.0	3 IN			
		14.0	6.0	3 IN	6.0	3 IN	6.0	3 IN			
Over 20	Protective systems for trenches over 20 feet shall be designed by a registered professional engineer. See WAC 296-155-655(1)										

NOTE (1): 2 inch diameter cylinders, at this width, shall have structural steel tube (3.5 X 3.5 X 0.1875) oversleeves, or structural oversleeves of manufacturer's specification, extending the full, collapsed length.

\*Consult product manufacturer and/or qualified engineer for Section Modulus of available wales.

**AMENDATORY SECTION** (Amending Order 90-18, filed 1/10/91, effective 2/12/91)

WAC 296-155-66109 ((APPROVAL OR DESIGN BY A REGISTERED PROFESSIONAL ENGINEER)) **RESERVED.** ((+)) Sloping systems, support systems, shield systems, or other protective systems not meeting the requirements of this part shall be approved by a registered professional engineer. Approval or designs shall be in written form and shall include the following:

(a) The magnitude of the slopes that were determined to be safe for the particular project and the configurations that were determined to be safe for the project, or a plan indicating the sizes, types, and configurations of the materials to be used in the protective system:

(b) The identity of the registered professional engineer approving the design:

(c) A copy of the approval or design shall be maintained at the work site and made available to the director or the authorized representative of the director upon request:

(2) Excavations not meeting the requirements of this part which are approved by a registered professional engineer shall be monitored as follows:

(a) The registered professional engineer shall inspect the work site at the beginning of each shift, after any change in weather conditions, and after any change in the circumstances of adjacent property:

(b) The registered professional engineer shall make a written report of each inspection, the report shall be kept on file at the work site, and the report shall be made available to the director or the authorized representative of the director upon request:

(c) All recommendations of the registered professional engineer regarding the excavation and soil conditions shall be followed:)

**AMENDATORY SECTION** (Amending Order 90-18, filed 1/10/91, effective 2/12/91)

WAC 296-155-664 (~~APPENDIX A—SOIL CLASSIFICATION~~) **APPENDICES.** ((~~(1) Scope and application—Scope. This appendix describes a method of classifying soil and rock deposits based on site and environmental conditions, and on the structure and composition of the earth deposits. The appendix contains definitions, sets forth requirements, and describes acceptable visual and manual tests for use in classifying soils.~~

(2) This appendix applies when constructing or using a protective system according to the requirements set forth in this part.

(3) Definitions. The definitions and examples below are based on the American Society for Testing Materials (ASTM) Standards D653-85 and D2488: The Unified Soils Classification System, U.S. Department of Agriculture (USDA) Textural Classification Scheme, and The National Bureau of Standards Report BSS-121:

(a) Cemented soil. A soil where the particles are held together by a chemical agent, such as calcium carbonate. A hand-size sample cannot be crushed into powder or individual soil particles by finger pressure.

(b) Cohesive soil. Dry clay (fine grained soil), or soil with a high clay content, which has cohesive strength. Cohesive soil does not crumble, can be excavated with vertical sideslopes, and is plastic when moist. Cohesive soil is hard to break up when dry, and exhibits significant cohesion when submerged. Cohesive soils include clayey silt, sandy clay, clay and organic clay.

(c) Dry soil. Soil that does not exhibit visible signs of moisture content.

(d) Fissured. A soil material that tends to break along definite planes of fracture with little resistance, or a material that exhibits open cracks, such as tension cracks, in an exposed surface.

(e) Granular soil. Gravel, sand, or silt, (coarse grained soil) with little or no clay content. Granular soil lacks cohesive strength. Some moist granular soils exhibit apparent cohesion. Granular soil cannot be molded when moist and crumbles easily when dry.

(f) Layered system. Two or more distinctly different soil or rock types arranged in layers. Micaceous seams or weakened planes in rock or shale are considered layered.

(g) Moist soil. A condition in which a soil looks and feels damp. Moist cohesive soil can easily be shaped into a ball and rolled into small diameter threads before crumbling. Moist granular soil that contains some cohesive material will exhibit signs of cohesion between particles.

(h) Plastic. A property of a soil that allows the soil to be deformed or molded without cracking, or appreciable volume change.

(i) Saturated soil. A soil in which the voids are filled with water. Saturation does not require flow. Saturation, or near saturation, is necessary for the proper use of instruments such as a pocket penetrometer or shear vane.

(j) Soil classification system. This section categorizes rock and soil into stable rock, type A, B, and C soils, in decreasing order of stability. Categories are based on properties analysis, performance characteristics, and environmental conditions.

(k) Stable rock. Natural solid mineral matter that can be excavated with vertical sides and remain intact while exposed.

(l) Submerged soil. Soil which is under water or is free seeping.

(m) Type A. Cohesive soils with an unconfined compressive strength of 1.5 ton per square foot (tsf) or greater. Examples of cohesive soils are clay, silty clay, sandy clay, clay loam and, sometimes, silty clay loam and sandy clay loam. Cemented soils such as caliche and hardpan are also considered Type A. No soil is Type A if:

(i) The soil is fissured; or  
(ii) The soil is subject to vibration from heavy traffic, pile driving, or similar effects; or

(iii) The soil has been previously disturbed; or

(iv) The soil is part of a sloped, layered system where the layers dip into the excavation on a slope of 4 horizontal to 1 vertical (4H:1V) or greater; or

(v) The material is subject to other factors that would require it to be classified as a less stable material.

(n) Type B:

(i) Cohesive soil with an unconfined compressive strength greater than 0.5 tsf, but less than 1.5 tsf; or

(ii) Granular cohesionless soils including angular gravel (similar to crushed rock), silt, silt loam, sand loam and, sometimes, silty clay loam and sandy clay loam;

(iii) Previously disturbed soils except those that would otherwise be classified as Type C soil;

(iv) Soil that meets the unconfined compressive strength or cementation requirements for Type A, but is fissured or subject to vibration; or

(v) Dry rock that is not stable; or

(vi) A sloped, layered system where the layers dip into the excavation on a slope less than 4 horizontal to 1 vertical (4H:1V), but only if the material would otherwise be classified as Type B;

(o) Type C:

(i) Cohesive soil with an unconfined compressive strength of 0.5 or less; or

(ii) Granular soils including gravel, sand, and loamy sand; or

(iii) Submerged soil or soil from which water is freely seeping; or

(iv) Submerged rock that is not stable; or

(v) Material in a sloped, layered system where the layers dip into the excavation on a slope of 4 horizontal to 1 vertical (4H:1V) or steeper;

(p) Unconfined compressive strength. The load per unit area at which a soil will fail in compression. It can be determined by laboratory testing, or estimated in the field using a pocket penetrometer, by thumb penetration tests, and other methods.

(q) Wet soil. Soil that contains significantly more moisture than moist soil, but in such a range of values that cohesive material will slump or begin to flow when vibrated. Granular material that would exhibit cohesive properties when moist will lose those cohesive properties when wet.

(4) Requirements—Classification of soil and rock deposits:

(a) Each soil and rock deposit shall be classified by a competent person as Stable Rock, Type A, B, or C according to the definitions set forth in subsection (3) of this appendix.

(b) Basis of classification. The classification of the deposits shall be made based on the results of at least one visual and at least one manual analysis. Such analyses shall be conducted by a competent person using tests in subsection (5) or in other recognized methods of soil classification and testing such as those adopted by the American Society for Testing Materials, or the U.S. Department of Agriculture textural classification system.

(c) Visual and manual analyses. The visual and manual analyses, such as noted in subsection (5) of this appendix, shall be designed and conducted to provide quantitative and qualitative information necessary to identify properly the properties, factors, and conditions affecting the classification of deposits.

(d) Layered systems. In a layered system, the system shall be classified according to its weakest layer. Each layer may be classified individually where a more stable layer lies under a less stable layer.

(e) Reclassification. If, after classifying a deposit, the properties, factors, or conditions affecting its classification change in any way, the changes shall be evaluated by a competent person. The deposit shall be reclassified as necessary to reflect the changed circumstances.

(5) Acceptable visual and manual tests:

(a) Visual tests. Visual analysis is conducted to determine qualitative information regarding the excavation site soil next to the excavation, soil at the sides of the excavation, and the soil taken as samples from excavated material:

(i) Observe samples of soil that are excavated and soil in the sides of the excavation. Estimate the range of particle sizes and the relative amounts of the particle sizes. Soil that is primarily composed of fine-grained material is cohesive material. Soil composed primarily of coarse-grained sand or gravel is granular material.

(ii) Observe soil as it is excavated. Soil that remains in clumps when excavated is cohesive. Soil that breaks up easily and does not stay in clumps is granular.

(iii) Observe the side of the opened excavation and the surface area by the excavation. Crack-like openings such as tension cracks could suggest fissured material. If chunks of soil spall off a vertical side, the soil could be fissured. Small spalls are evidence of moving ground and are indications of potentially hazardous situations.

(iv) Observe the area by the excavation and the excavation itself for evidence of existing utility and other underground structures, and to identify previously disturbed soil.

(v) Observe the opened side of the excavation to identify layered systems. Examine layered systems to identify if the layers slope toward the excavation. Estimate the degree of slope of the layers.

(vi) Observe the excavation and sides of the excavation for evidence of surface water, water seeping from the sides of the excavation, or the level of the water table.

(vii) Observe the area by the excavation and the area within the excavation for sources of vibration that may affect the stability of the excavation face.

(b) Manual tests. Manual analysis of soil samples is conducted to find quantitative, also, qualitative properties of soil and to provide more information in order to classify soil properly:

(i) Plasticity. Mold a moist or wet sample of soil into a ball and attempt rolling it into threads as thin as 1/8-inch in diameter. Cohesive material can be successfully rolled into threads without crumbling. For example, if at least a 2-inch length of 1/8-inch thread can be held on one end without tearing, the soil is cohesive.

(ii) Dry strength. If the soil is dry and crumbles on its own or with moderate pressure into grains or fine powder, it is granular (any combination of gravel, sand, or silt). If the soil is dry, falls into clumps that break into smaller clumps, and those clumps are broken with difficulty, it may be clay with gravel, sand or silt. If dry soil clumps are broken with difficulty into smaller clumps, and there is no indication the soil is fissured, it may be considered unfissured.

(iii) Thumb penetration. The thumb penetration test can be used to estimate the unconfined compressive strength of cohesive soils. (This test is based on the thumb penetration test described in American Society for Testing and Materials (ASTM) Standard designation D2488—"Standard Recommended Practice for Description of Soils (Visual—Manual Procedure).") Type A soils with an unconfined compressive strength of 1.5 tsf can be readily indented by the thumb and penetrated by the thumb with great effort. Type C soils with an unconfined compressive strength of 0.5 tsf can be easily penetrated several inches by the thumb, and can be molded by light finger pressure. This test should be conducted on an undisturbed soil sample, such as a large clump of spoil, soon after excavation to keep drying effects to a minimum. If the excavation is later exposed to wetting (rain, flooding); the classification of the soil must be changed accordingly.

(iv) Other strength tests. Estimates of unconfined compressive strength of soils also can be obtained by use of a pocket penetrometer or by using a hand-operated shear vane.

(v) Drying test. The basic purpose of the drying test is to differentiate between cohesive material with fissures, unfissured cohesive material, and granular material. The procedure for the drying test involves drying a sample of soil that is approximately 1-inch thick and 6 inches in diameter until it is thoroughly dry:

(A) If the sample develops cracks as it dries, significant fissures are indicated.

(B) Samples that dry without cracking are to be broken by hand. If considerable force is necessary to break a sample, the soil has significant cohesive material content. The soil can be classified as a unfissured cohesive material and the unconfined compressive strength should be determined.

(C) If a sample breaks easily by hand, it is either a fissured cohesive material or a granular material. To distinguish between the two, pulverize the dried clumps of the sample by hand or by stepping on them. If the clumps do not pulverize easily, the material is cohesive with fissures. If they pulverize easily into very small fragments, the material is granular.)

## NEW SECTION

WAC 296-155-66401 APPENDIX A—SOIL CLASSIFICATION. (1) Scope and application.

(a) Scope. This appendix describes a method of classifying soil and rock deposits based on site and environmental conditions, and on the structure and composition of the earth deposits. The appendix contains definitions, sets forth requirements, and describes acceptable visual and manual tests for use in classifying soils.

(b) Application. This appendix applies when a sloping or benching system is designed in accordance with the requirements set forth in WAC 296-155-657 (2)(b) as a method of protection for employees from cave-ins. This appendix also applies when timber shoring for excavations is designed as a method of protection from cave-ins in accordance with appendix C to part N of this chapter, and when aluminum hydraulic shoring is designed in accordance with appendix D. This Appendix also applies if other protective systems are designed and

selected for use from data prepared in accordance with the requirements set forth in WAC 296-155-657(3), and the use of the data is predicated on the use of the soil classification system set forth in this appendix.

(2) Definitions. The definitions and examples given below are based on, in whole or in part, the following: American Society for Testing Materials (ASTM) Standards D653-85 and D2488; The Unified Soils Classification System, The U.S. Department of Agriculture (USDA) Textural Classification Scheme; and The National Bureau of Standards Report BSS-121.

(a) Cemented soil. A soil in which the particles are held together by a chemical agent, such as calcium carbonate such that a hand-size sample cannot be crushed into powder or individual soil particles by finger pressure.

(b) Cohesive soil. Clay (fine grained soil), or soil with a high clay content, which has cohesive strength. Cohesive soil does not crumble, can be excavated with vertical sideslopes, and is plastic when moist. Cohesive soil is hard to break up when dry, and exhibits significant cohesion when submerged. Cohesive soils include clayey silt, sandy clay, silty clay, clay and organic clay.

(c) Dry soil. Soil that does not exhibit visible signs of moisture content.

(d) Fissured. A soil material that has a tendency to break along definite planes of fracture with little resistance, or a material that exhibits open cracks, such as tension cracks, in an exposed surface.

(e) Granular soil. Gravel, sand, or silt, (coarse grained soil) with little or no clay content. Granular soil has no cohesive strength. Some moist granular soils exhibit apparent cohesion. Granular soil cannot be molded when moist and crumbles easily when dry.

(f) Layered system. Two or more distinctly different soil or rock types arranged in layers. Micaceous seams or weakened planes in rock or shale are considered layered.

(g) Moist soil. A condition in which a soil looks and feels damp. Moist cohesive soil can easily be shaped into a ball and rolled into small diameter threads before crumbling. Moist granular soil that contains some cohesive material will exhibit signs of cohesion between particles.

(h) Plastic. A property of a soil which allows the soil to be deformed or molded without cracking, or appreciable volume change.

(i) Saturated soil. A soil in which the voids are filled with water. Saturation does not require flow. Saturation, or near saturation, is necessary for the proper use of instruments such as a pocket penetrometer or shear vane.

(j) Soil classification system. For the purpose of this part, a method of categorizing soil and rock deposits in a hierarchy of Stable Rock, Type A, Type B, and Type C, in decreasing order of stability. The categories are determined based on an analysis of the properties and performance characteristics of the deposits and the environmental conditions of exposure.

(k) Stable rock. Natural solid mineral matter that can be excavated with vertical sides and remain intact while exposed.

(l) Submerged soil. Soil which is underwater or is free seeping.

(m) Type A. Cohesive soils with an unconfined compressive strength of 1.5 ton per square foot (tsf) (144 kPa) or greater. Examples of cohesive soils are: Clay, silty clay, sandy clay, clay loam and, in some cases, silty clay loam and sandy clay loam. Cemented soils such as caliche and hardpan are also considered Type A. No soil is Type A if:

(i) The soil is fissured; or

(ii) The soil is subject to vibration from heavy traffic, pile driving, or similar effects; or

(iii) The soil has been previously disturbed; or

(iv) The soil is part of a sloped, layered system where the layers dip into the excavation on a slope of 4 horizontal to 1 vertical (4H:1V) or greater; or

(v) The material is subject to other factors that would require it to be classified as a less stable material.

(n) Type B.

(i) Cohesive soil with an unconfined compressive strength greater than 0.5 tsf (48 kPa) but less than 1.5 tsf (144 kPa): or

(ii) Granular cohesionless soils including: Angular gravel (similar to crushed rock), silt, silt loam, sandy loam and, in some cases, silty clay loam and sandy clay loam.

(iii) Previously disturbed soils except those which would otherwise be classed as Type C soil.

(iv) Soil that meets the unconfined compressive strength or cementation requirements for Type A, but is fissured or subject to vibration: or

- (v) Dry rock that is not stable: or
- (vi) Material that is part of a sloped, layered system where the layers dip into the excavation on a slope less steep than 4 horizontal to 1 vertical (4H.1V), but only if the material would otherwise be classified as Type B.
  - (a) Type C.
  - (i) Cohesive soil with an unconfined compressive strength of 0.5 tsf (48 kPa) or less: or
  - (ii) Granular soils including gravel, sand, and loamy sand: or
  - (iii) Submerged soil or soil from which water is freely seeping: or
  - (iv) Submerged rock that is not stable, or
  - (v) Material in a sloped, layered system where the layers dip into the excavation or a slope of 4 horizontal to 1 vertical (4H.1V) or steeper.
  - (p) Unconfined compressive strength. The load per unit area at which a soil will fail in compression. It can be determined by laboratory testing, or estimated in the field using a pocket penetrometer, by thumb penetration tests, and other methods.
  - (q) Wet soil. Soil that contains significantly more moisture than moist soil, but in such a range of values that cohesive material will slump or begin to flow when vibrated. Granular material that would exhibit cohesive properties when moist will lose those cohesive properties when wet.
- (3) Requirements.
  - (a) Classification of soil and rock deposits. Each soil and rock deposit shall be classified by a competent person as Stable Rock, Type A, Type B, or Type C in accordance with the definitions set forth in subsection (2) of this section.
  - (b) Basis of classification. The classification of the deposits shall be made based on the results of at least one visual and at least one manual analysis. Such analyses shall be conducted by a competent person using tests in subsection (4) of this section or in other recognized methods of soil classification and testing such as those adopted by the American Society for Testing Materials, or the U.S. Department of Agriculture textural classification system.
  - (c) Visual and manual analyses. The visual and manual analyses, such as those noted as being acceptable in subsection (4) of this section, shall be designed and conducted to provide sufficient quantitative and qualitative information as may be necessary to identify properly the properties, factors, and conditions affecting the classification of the deposits.
  - (d) Layered systems. In a layered system, the system shall be classified in accordance with its weakest layer. However, each layer may be classified individually where a more stable layer lies under a less stable layer.
  - (e) Reclassification. If, after classifying a deposit, the properties, factors, or conditions affecting its classification change in any way, the changes shall be evaluated by a competent person. The deposit shall be reclassified as necessary to reflect the changed circumstances.
  - (4) Acceptable visual and manual tests.
    - (a) Visual tests. Visual analysis is conducted to determine qualitative information regarding the excavation site in general, the soil adjacent to the excavation, the soil forming the sides of the open excavation, and the soil taken as samples from excavated material.
      - (i) Observe samples of soil that are excavated and soil in the sides of the excavation. Estimate the range of particle sizes and the relative amounts of the particle sizes. Soil that is primarily composed of fine-grained material is cohesive material. Soil composed primarily of coarse-grained sand or gravel is granular material.
      - (ii) Observe soil as it is excavated. Soil that remains in clumps when excavated is cohesive. Soil that breaks up easily and does not stay in clumps is granular.
      - (iii) Observe the side of the opened excavation and the surface area adjacent to the excavation. Crack-like openings such as tension cracks could indicate fissured material. If chunks of soil spall off a vertical side, the soil could be fissured. Small spalls are evidence of moving ground and are indications of potentially hazardous situations.
      - (iv) Observe the area adjacent to the excavation and the excavation itself for evidence of existing utility and other underground structures, and to identify previously disturbed soil.
      - (v) Observe the opened side of the excavation to identify layered systems. Examine layered systems to identify if the layers slope toward the excavation. Estimate the degree of slope of the layers.
      - (vi) Observe the area adjacent to the excavation and sides of the open excavation for evidence of surface water, water seeping from the sides of the excavation, or the location of the level of the water table.

(vii) Observe the area adjacent to the excavation and the area within the excavation for sources of vibration that may affect the stability of the excavation face.

(b) Manual tests. Manual analysis of soil samples is conducted to determine quantitative as well as qualitative properties of soil and to provide more information in order to classify soil properly.

(i) Plasticity. Mold a moist or wet sample of soil into a ball and attempt to roll it into threads as thin as 1/8-inch in diameter. Cohesive material can be successfully rolled into threads without crumbling. For example, if at least a 2 inch (50 mm) length of 1/8-inch thread can be held on one end without tearing, the soil is cohesive.

(ii) Dry strength. If the soil is dry and crumbles on its own or with moderate pressure into individual grains or fine powder, it is granular (any combination of gravel, sand, or silt). If the soil is dry and falls into clumps which break up into smaller clumps, but the smaller clumps can only be broken up with difficulty, it may be clay in any combination with gravel, sand or silt. If the dry soil breaks into clumps which do not break up into small clumps and which can only be broken with difficulty, and there is no visual indication the soil is fissured, the soil may be considered unfissured.

(iii) Thumb penetration. The thumb penetration test can be used to estimate the unconfined compressive strength of cohesive soils. (This test is based on the thumb penetration test described in American Society for Testing and Materials (ASTM) Standard designation D2488—"Standard Recommended Practice for Description of Soils (Visual—Manual Procedure).") Type A soils with an unconfined compressive strength of 1.5 tsf can be readily indented by the thumb; however, they can be and penetrated by the thumb only with very great effort. Type C soils with an unconfined compressive strength of 0.5 tsf can be easily penetrated several inches by the thumb, and can be molded by light finger pressure. This test should be conducted on an undisturbed soil sample, such as a large clump of spoil, as soon as practicable after excavation to keep to a minimum the effects of exposure to drying influences. If the excavation is later exposed to wetting influences (rain, flooding), the classification of the soil must be changed accordingly.

(iv) Other strength tests. Estimates of unconfined compressive strength of soils can also be obtained by use of a pocket penetrometer or by using a hand-operated shear vane.

(v) Drying test. The basic purpose of the drying test is to differentiate between cohesive material with fissures, unfissured cohesive material, and granular material. The procedure for the drying test involves drying a sample of soil that is approximately 1 inch thick (2.54 cm) and 6 inches (15.24 cm) in diameter until it is thoroughly dry:

(A) If the sample develops cracks as it dries, significant fissures are indicated.

(B) Samples that dry without cracking are to be broken by hand. If considerable force is necessary to break a sample, the soil has significant cohesive material content. The soil can be classified as a unfissured cohesive material and the unconfined compressive strength should be determined.

(C) If a sample breaks easily by hand, it is either a fissured cohesive material or a granular material. To distinguish between the two, pulverize the dried clumps of the sample by hand or by stepping on them. If the clumps do not pulverize easily, the material is cohesive with fissures. If they pulverize easily into very small fragments, the material is granular.

#### NEW SECTION

WAC 296-155-66403 APPENDIX B—SLOPING AND BENCHING. (1) Scope and application. This appendix contains specifications for sloping and benching when used as methods of protecting employees working in excavations from cave-ins. The requirements of this appendix apply when the design of sloping and benching protective systems is to be performed in accordance with the requirements set forth in WAC 296-155-657 (2)(b).

#### (2) Definitions.

(a) Actual slope. The slope to which an excavation face is excavated.

(b) Distress. Soil that is in a condition where a cave-in is imminent or is likely to occur. Distress is evidenced by such phenomena as the development of fissures in the face of or adjacent to an open excavation; the subsidence of the edge of an excavation; the slumping of material from the face or the bulging or heaving of material from the bottom of an excavation; the spalling of material from the face of an excavation; and raveling, i.e., small amounts of material such as pebbles or little clumps of material suddenly separating from the face of an excavation and trickling or rolling down into the excavation.

(c) Maximum allowable slope. The steepest incline of an excavation face that is acceptable for the most favorable site conditions as protection against cave-ins, and is expressed as the ratio of horizontal distance to vertical rise (H:V).

(3) Requirements.

(a) Soil classification. Soil and rock deposits shall be classified in accordance with appendix A of this Part.

(b) Maximum allowable slope. The maximum allowable slope for a soil or rock deposit shall be determined from Table N-1 of this appendix.

(c) Actual slope.

(i) The actual slope shall not be steeper than the maximum allowable slope.

(ii) The actual slope shall be less steep than the maximum allowable slope, when there are signs of distress. If that situation occurs, the slope shall be cut back to an actual slope which is at least 1/2 horizontal to one vertical (1/2H:1V) less steep than the maximum allowable slope.

(iii) When surcharge loads from stored material or equipment, operating equipment, or traffic are present, a competent person shall determine the degree to which the actual slope must be reduced below the maximum allowable slope, and shall assure that such reduction is achieved. Surcharge loads from adjacent structures shall be evaluated in accordance with WAC 296-155-655(9).

(d) Configurations. Configurations of sloping and benching systems shall be in accordance with Figures N-1 through N-18.

TABLE N-1  
MAXIMUM ALLOWABLE SLOPES

SOIL OR ROCK TYPE	MAXIMUM ALLOWABLE SLOPES (H:V) <sup>(1)</sup> FOR EXCAVATION LESS THAN 20 FEET DEEP <sup>(2)</sup>
STABLE ROCK	VERTICAL (90°)
TYPE A	3/4:1 (53°)
TYPE B	1:1 (45°)
TYPE C	1 1/2:1 (34°)

NOTES:

- [1] Numbers shown in parentheses next to maximum allowable slopes are angles expressed in degrees from the horizontal. Angles have been rounded off.
- [2] Sloping or benching for excavations greater than 20 feet deep shall be designed by a registered professional engineer.

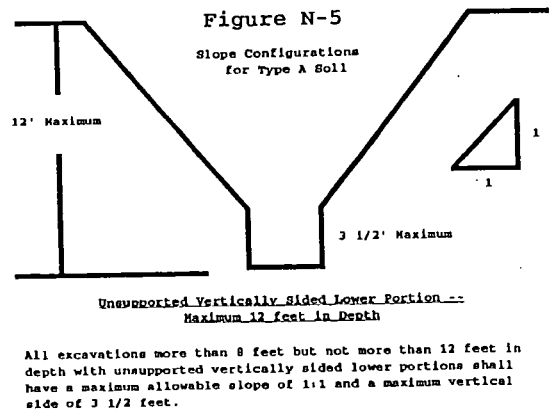
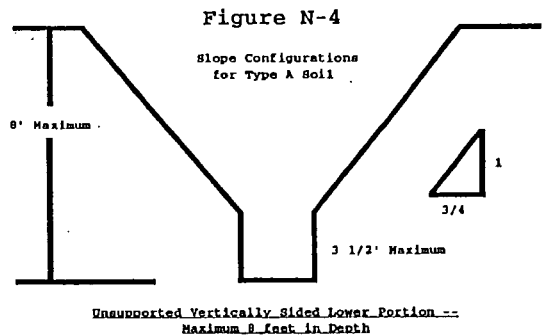
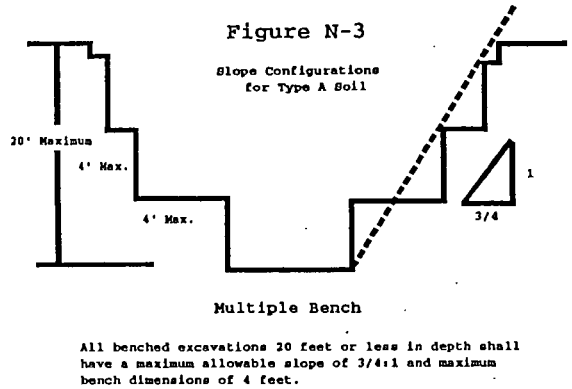
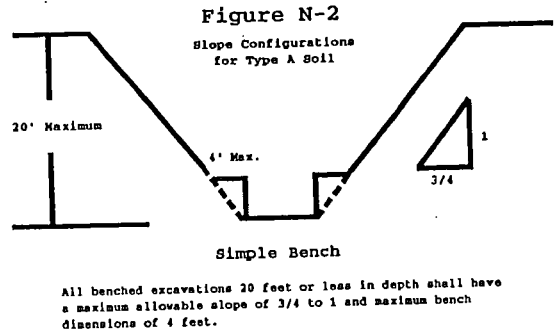
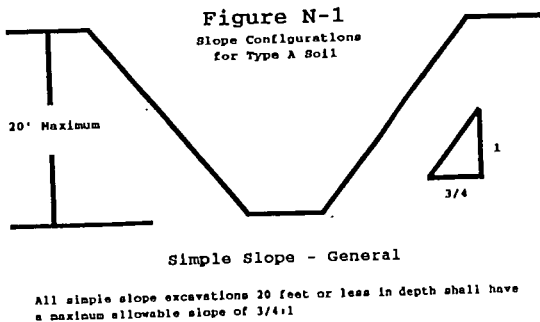



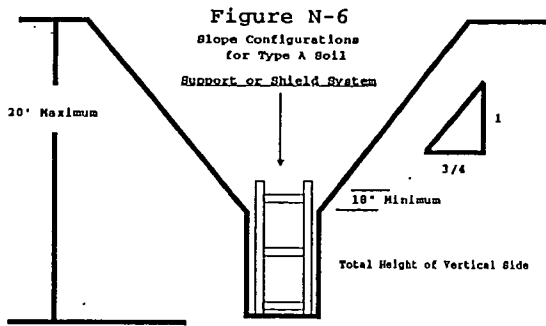

Unsupported Vertically Sided Lower Portion --  
Maximum 12 feet in Depth

All excavations 20 feet or less in depth which have vertically sided lower portions that are supported or shielded shall have a maximum allowable slope of 3/4:1. The support or shield system must extend at least 18 inches above the top of the vertical side.

All other simple slope, compound slope, and vertically sided lower portion excavations shall be in accordance with other options permitted under WAC 296-155-637(2).

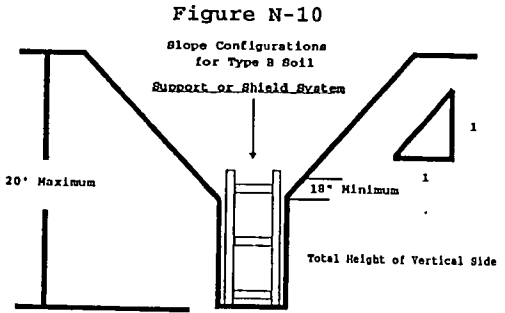

Vertically Sided Lower Portion

All excavations 20 feet or less in depth which have vertically sided lower portions shall be shielded or supported to a height at least 18 inches above the top of the vertical side. All such excavations shall have a maximum allowable slope of 1:1.

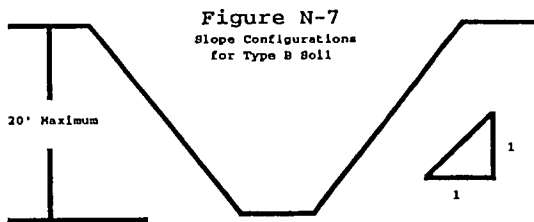

Simple Slope

All simple slope excavations 20 feet or less in depth shall have a maximum allowable slope of 1:1.

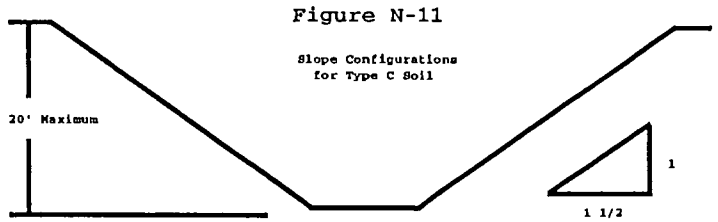

Simple Slope

All simple slope excavations 20 feet or less in depth shall have a maximum allowable slope of 1 1/2:1.

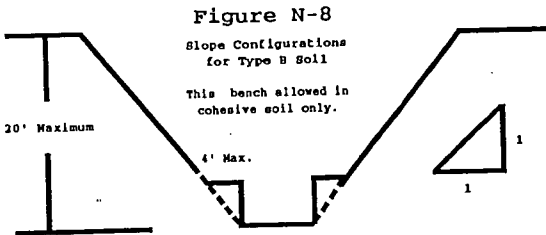

Single Bench

All benched excavations 20 feet or less in depth shall have a maximum allowable slope of 1:1 and maximum bench dimensions of 4 feet.

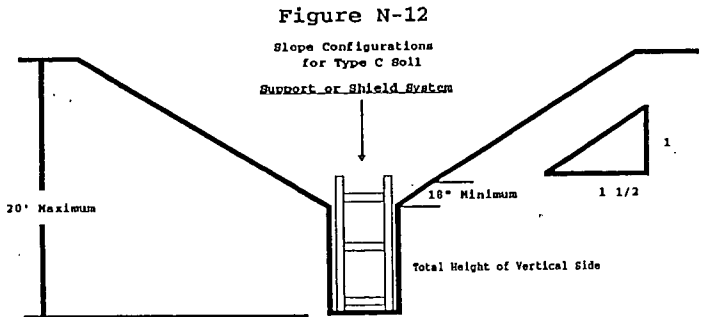

Vertically Sided Lower Portion

All excavations 20 feet or less in depth which have vertically sided lower portions shall be shielded or supported to a height at least 18 inches above the top of the vertical side. All such excavations shall have a maximum allowable slope of 1 1/2:1.

**EXCAVATIONS MADE IN LAYERED SOILS**

All excavations 20 feet or less in depth made in layered soils shall have a maximum allowable slope for each layer as set forth below.

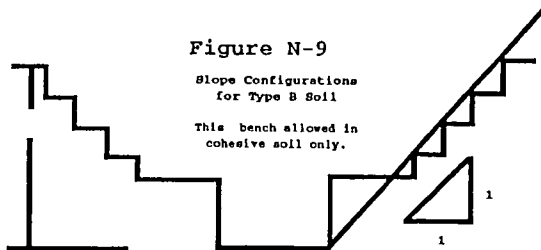

Figure N-9

Slope Configurations for Type B Soil

This bench allowed in cohesive soil only.

All benched excavations 20 feet or less in depth shall have a maximum allowable slope of 1:1 and maximum bench dimensions of 4 feet.

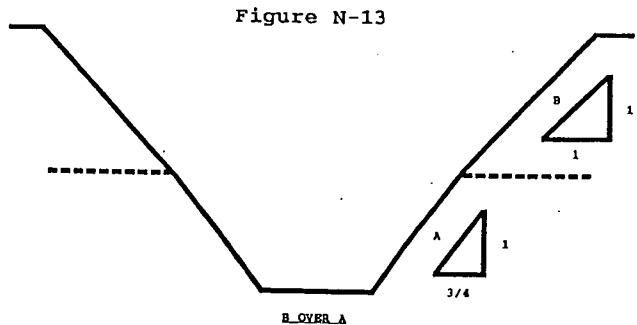

Figure N-13

B\_OVER\_A

Figure N-14

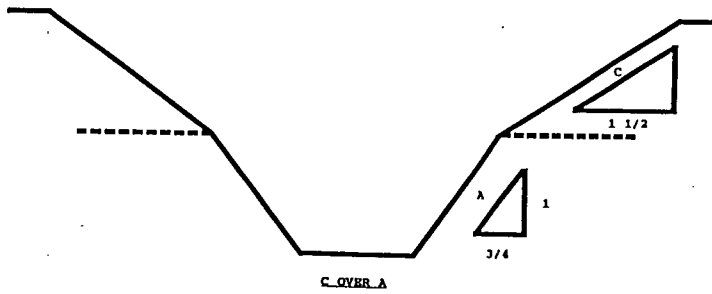

Figure N-15

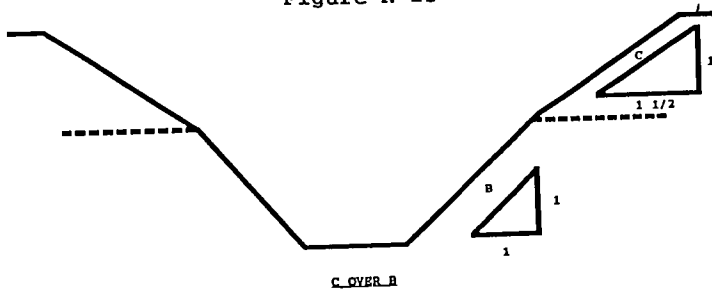

Figure N-16

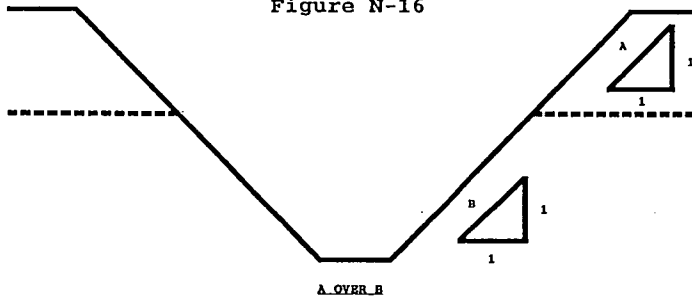

Figure N-17

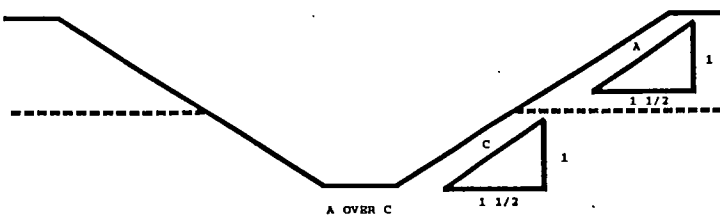
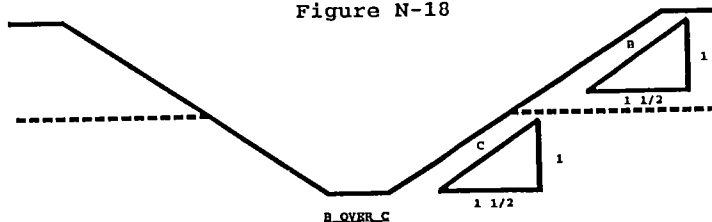

Figure N-18



that can be used when timber shoring is provided as a method of protection from cave-ins in trenches that do not exceed 20 feet (6.1 m) in depth. This appendix must be used when design of timber shoring protective systems is to be performed in accordance with WAC 296-155-657 (3)(a). Other timber shoring configurations; other systems of support such as hydraulic and pneumatic systems; and other protective systems such as sloping, benching, shielding, and freezing systems must be designed in accordance with the requirements set forth in WAC 296-155-657 (2) and (3).

(2) Soil classification. In order to use the data presented in this appendix, the soil type or types in which the excavation is made must first be determined using the soil classification method set forth in appendix A of this part.

(3) Presentation of information. Information is presented in several forms as follows:

(a) Information is presented in tabular form in Tables N-2 through N-7 following subsection (7) of this appendix. Each table presents the minimum sizes of timber members to use in a shoring system, and each table contains data only for the particular soil type in which the excavation or portion of the excavation is made. The data are arranged to allow the user the flexibility to select from among several acceptable configurations of members based on varying the horizontal spacing of the crossbraces. Stable rock is exempt from shoring requirements and therefore, no data are presented for this condition.

(b) Information concerning the basis of the tabular data and the limitations of the data is presented in subsection (4) of this appendix, and on the tables themselves.

(c) Information explaining the use of the tabular data is presented in subsection (5) of this appendix.

(d) Information illustrating the use of the tabular data is presented in subsection (6) of this appendix.

(e) Miscellaneous notations regarding Tables N-2 through N-7 are presented in subsection (7) of this Appendix.

(4) Basis and limitations of the data.

(a) Dimensions of timber members.

(i) The sizes of the timber members listed in Tables N-2 through N-7 are taken from the National Bureau of Standards (NBS) report, "Recommended Technical Provisions for Construction Practice in Shoring and Sloping of Trenches and Excavations." In addition, where NBS did not recommend specific sizes of members, member sizes are based on an analysis of the sizes required for use by existing codes and on empirical practice.

(ii) The required dimensions of the members listed in Tables N-2, N-3, and N-4 refer to actual dimensions and not nominal dimensions of the timber. Employers wanting to use nominal size shoring are directed to Tables N-5, N-6, and N-7, or have this choice under WAC 296-155-657 (3)(c), and are referred to The Corps of Engineers, The Bureau of Reclamation or data from other acceptable sources.

(b) Limitation of application.

(i) It is not intended that the timber shoring specification apply to every situation that may be experienced in the field. These data were developed to apply to the situations that are most commonly experienced in current trenching practice. Shoring systems for use in situations that are not covered by the data in this appendix must be designed as specified in WAC 296-155-657(3).

(ii) When any of the following conditions are present, the members specified in the tables are not considered adequate. Either an alternate timber shoring system must be designed or another type of protective system designed in accordance with WAC 296-155-657.

(A) When loads imposed by structures or by stored material adjacent to the trench weigh in excess of the load imposed by a two-foot soil surcharge. The term "adjacent" as used here means the area within a horizontal distance from the edge of the trench equal to the depth of the trench.

(B) When vertical loads imposed on cross braces exceed a 240-pound gravity load distributed on a one-foot section of the center of the crossbrace.

(C) When surcharge loads are present from equipment weighing in excess of 20,000 pounds.

(D) When only the lower portion of a trench is shored and the remaining portion of the trench is sloped or benched unless: The sloped portion is sloped at an angle less steep than three horizontal to one vertical; or the members are selected from the tables for use at a depth which is determined from the top of the overall trench, and not from the toe of the sloped portion.

(5) Use of Tables. The members of the shoring system that are to be selected using this information are the cross braces, the uprights, and

**NEW SECTION**

WAC 296-155-66405 APPENDIX C—TIMBER SHORING FOR TRENCHES. (1) Scope. This appendix contains information

the wales, where wales are required. Minimum sizes of members are specified for use in different types of soil. There are six tables of information, two for each soil type. The soil type must first be determined in accordance with the soil classification system described in appendix A of this Part. Using the appropriate table, the selection of the size and spacing of the members is then made. The selection is based on the depth and width of the trench where the members are to be installed and, in most instances, the selection is also based on the horizontal spacing of the crossbraces. Instances where a choice of horizontal spacing of crossbracing is available, the horizontal spacing of the crossbraces must be chosen by the user before the size of any member can be determined. When the soil type, the width and depth of the trench, and the horizontal spacing of the crossbraces are known, the size and vertical spacing of the crossbraces, the size and vertical spacing of the wales, and the size and horizontal spacing of the uprights can be read from the appropriate table.

(6) Examples to illustrate the use of Tables N-2 through N-4.

(a) Example 1.

A trench dug in Type A soil is 13 feet deep and five feet wide.

From Table N-2, for acceptable arrangements of timber can be used.

Arrangement #1

Space 4x4 crossbraces at six feet horizontally and four feet vertically.

Wales are not required.

Space 3x8 uprights at six feet horizontally. This arrangement is commonly called "skip shoring."

Arrangement #2

Space 4x6 crossbraces at eight feet horizontally and four feet vertically.

Space 8x8 wales at four feet vertically.

Space 2x6 uprights at four feet horizontally.

Arrangement #3

Space 6x6 crossbraces at 10 feet horizontally and four feet vertically.

Space 8x10 wales at four feet vertically.

Space 2x6 uprights at five feet horizontally.

Arrangement #4

Space 6x6 crossbraces at 12 feet horizontally and four feet vertically.

Space 10x10 wales at four feet vertically.

Space 3x8 uprights at six feet horizontally.

(b) Example 2.

A trench dug in Type B soil in 13 feet deep and five feet wide.

From Table N-3 three acceptable arrangements of members are listed.

Arrangement #1

Space 6x6 crossbraces at six feet horizontally and five feet vertically.

Space 8x8 wales at five feet vertically.

Space 2x6 uprights at two feet horizontally.

Arrangement #2

Space 6x8 crossbraces at eight feet horizontally and five feet vertically.

Space 10x10 wales at five feet vertically.

Space 2x6 uprights at two feet horizontally.

Arrangement #3

Space 8x8 crossbraces at 10 feet horizontally and five feet vertically.

Space 10x12 wales at five feet vertically.

Space 2x6 uprights at two feet horizontally.

(c) Example 3.

A trench dug Type C soil is 13 feet deep and five feet wide.

From Table N-4 two acceptable arrangements of members can be used.

Arrangement #1

Space 8x8 crossbraces at six feet horizontally and five feet vertically.

Space 10x12 wales at five feet vertically.

Position 2x6 uprights as closely together as possible.

If water must be retained use special tongue and groove uprights to form tight sheeting.

Arrangement #2

Space 8x10 crossbraces at eight feet horizontally and five feet vertically.

Space 12x12 wales at five feet vertically.

Position 2x6 uprights in a close sheeting configuration unless water pressure must be resisted. Tight sheeting must be used where water must be retained.

(d) Example 4.

A trench dug in Type C soil is 20 feet deep and 11 feet wide. The size and spacing of members for the section of trench that is over 15 feet in depth is determined using Table N-4. Only one arrangement of members is provided.

Space 8x10 crossbraces at six feet horizontally and five feet vertically.

Space 12x12 wales at five feet vertically.

Use 3x6 tight sheeting.

Use of Tables N-5, N-6, and N-7 would follow the same procedures.

(7) Notes for all tables.

(a) Member sizes at spacings other than indicated are to be determined as specified in WAC 296-155-657(3). "Design of Protective Systems."

(b) When conditions are saturated or submerged use Tight Sheeting. Tight Sheeting refers to the use of specially-edged timber planks (e.g., tongue and groove) at least three inches thick, steel sheet piling, or similar construction that when driven or placed in position provide a tight wall to resist the lateral pressure of water and to prevent the loss of backfill material. Close Sheeting refers to the placement of planks side-by-side allowing as little space as possible between them.

(c) All spacing indicated is measured center to center.

(d) Wales to be installed with greater dimension horizontal.

(e) If the vertical distance from the center of the lowest crossbrace to the bottom of the trench exceeds two and one-half feet, uprights shall be firmly embedded or a mudsill shall be used. Where uprights are embedded, the vertical distance from the center of the lowest crossbrace to the bottom of the trench shall not exceed 36 inches. When mudsills are used, the vertical distance shall not exceed 42 inches. Mudsills are wales that are installed at the toe of the trench side.

(f) Trench jacks may be used in lieu of or in combination with timber crossbraces.

(g) Placement of crossbraces. When the vertical spacing of crossbraces is four feet, place the top crossbrace no more than two feet below the top of the trench. When the vertical spacing of crossbraces is five feet, place the top crossbrace no more than 2.5 feet below the top of the trench.

TABLE N-1  
TIMBER TRENCH SHORING - MINIMUM MEMBER REQUIREMENTS \*  
SOIL TYPE A \* - 15 X 11 - 71 psi (3 R. Surcharge)

DEPTH OF TRENCH (FEET)	SIZE (ACTUAL) AND SPACING OF MEMBERS **												
	CROSS BRACES					WALES			UPRIGHTS				
	HORIZ. SPACING (FEET)	UP TO 4	UP TO 6	UP TO 9	UP TO 12	VERT. SPACING (FEET)	SIZE (IN)	VERT. SPACING (FEET)	MAXIMUM AT LOWABLE	MINIMUM AT LOWABLE	HORIZONTAL SPACING (FEET)		
4	UP TO 6	4X4	4X4	4X6	6X6	4	8X8	4	CLOSE	4	2	6	8
	UP TO 8	4X4	4X4	4X6	6X6	4	8X8	4				2X6	
	UP TO 10	4X6	4X6	4X6	6X6	4	8X8	4			2X6		
10	UP TO 6	4X4	4X4	4X6	6X6	4	8X8	4				2X6	
	UP TO 8	4X4	4X4	4X6	6X6	4	8X8	4			2X6		
	UP TO 10	4X6	4X6	4X6	6X6	4	8X10	4			2X6		
15	UP TO 6	4X4	4X4	4X6	6X6	4	8X8	4				3X8	
	UP TO 8	4X4	4X4	4X6	6X6	4	8X8	4			2X6		
	UP TO 10	4X6	4X6	4X6	6X6	4	8X10	4			2X6		
20	UP TO 6	4X4	4X4	4X6	6X6	4	10X10	4				3X8	
	UP TO 8	4X4	4X4	4X6	6X6	4	8X8	4			3X6		
	UP TO 10	4X6	4X6	4X6	6X6	4	8X10	4			3X6		
OVER 20	SEE NOTE 1												

\* Mixed oak or equivalent with a bending strength not less than 550 psi.  
\*\* Manufactured members of equivalent strength may be substituted for wood.

**TABLE N-1**  
TIMBER TRENCH SHORING - MINIMUM TIMBER REQUIREMENTS \*  
SOIL TYPE B P<sub>c</sub> - 45 X 11 + 72 psf (1 R. Surcharge)

DEPTH OF TRENCH (FEET)	SIZE (ACTUAL) AND SPACING OF MEMBERS **														
	HORIZ. SPACING (FEET)	CROSS BRACES					WALES		UPRIGHTS						
		UP TO 4	UP TO 6	UP TO 9	UP TO 12	UP TO 15	VERT. SPACING (FEET)	SIZE (IN.)	VERT. SPACING (FEET)	MAXIMUM ALLOWABLE HORIZONTAL SPACING (FEET)					
4 TO 10	UP TO 6	4X6	4X6	6X6	6X6	6X6	5	6X8	5				2X6		
	UP TO 8	6X6	6X6	6X6	6X8	6X8	5	8X10	5				2X6		
	UP TO 10	6X6	6X6	6X6	6X8	6X8	5	10X10	5				2X6		
10 TO 15	UP TO 6	6X6	6X6	6X6	6X8	6X8	5	8X8	5				2X6		
	UP TO 8	6X8	6X8	6X8	8X8	8X8	5	10X10	5				2X6		
	UP TO 10	8X8	8X8	8X8	8X10	8X10	5	10X12	5				2X6		
15 TO 20	UP TO 6	6X8	6X8	6X8	8X8	8X8	5	8X10	5				3X6		
	UP TO 8	8X8	8X8	8X8	8X10	8X10	5	10X12	5				3X6		
	UP TO 10	8X10	8X10	8X10	8X10	10X10	5	12X12	5				3X6		
OVER 20	SEE NOTE 1														

\* Mixed oak or equivalent with a bending strength not less than 850 psi.  
\*\* Manufactured members of equivalent strength may be substituted for wood.

**TABLE N-2**

TIMBER TRENCH SHORING - MINIMUM TIMBER REQUIREMENTS \*  
SOIL TYPE C P<sub>c</sub> - 88 X 11 + 72 psf (1 R. Surcharge)

DEPTH OF TRENCH (FEET)	SIZE (ACTUAL) AND SPACING OF MEMBERS **														
	HORIZ. SPACING (FEET)	CROSS BRACES					WALES		UPRIGHTS						
		UP TO 4	UP TO 6	UP TO 9	UP TO 12	UP TO 15	VERT. SPACING (FEET)	SIZE (IN.)	VERT. SPACING (FEET)	MAXIMUM ALLOWABLE HORIZONTAL SPACING (FEET)					
4 TO 10	UP TO 6	6X8	6X8	6X8	8X8	8X8	5	8X10	5				2X6		
	UP TO 8	8X8	8X8	8X8	8X10	8X10	5	10X12	5				2X6		
	UP TO 10	8X10	8X10	8X10	8X10	10X10	5	12X12	5				2X6		
10 TO 15	UP TO 6	8X8	8X8	8X8	8X10	8X10	5	10X12	5				2X6		
	UP TO 8	8X10	8X10	8X10	8X10	10X10	5	12X12	5				2X6		
	UP TO 10	8X10	8X10	8X10	8X10	10X10	5	12X12	5				2X6		
15 TO 20	UP TO 6	8X10	8X10	8X10	8X10	10X10	5	12X12	5				3X6		
	UP TO 8														
	UP TO 10														
OVER 20	SEE NOTE 1														

\* Mixed Oak or equivalent with a bending strength not less than 850 psi.  
\*\* Manufactured members of equivalent strength may be substituted for wood.

**TABLE N-3**

TIMBER TRENCH SHORING - MINIMUM TIMBER REQUIREMENTS \*  
SOIL TYPE A P<sub>c</sub> - 15 X 11 + 72 psf (1 R. Surcharge)

DEPTH OF TRENCH (FEET)	SIZE (S4S) AND SPACING OF MEMBERS **														
	HORIZ. SPACING (FEET)	CROSS BRACES					WALES		UPRIGHTS						
		UP TO 4	UP TO 6	UP TO 9	UP TO 12	UP TO 15	VERT. SPACING (FEET)	SIZE (IN.)	VERT. SPACING (FEET)	MAXIMUM ALLOWABLE HORIZONTAL SPACING (FEET)					
4 TO 10	UP TO 6	4X4	4X4	4X4	4X4	4X4	4	Not Req'd	Not Req'd					4X6	
	UP TO 8	4X4	4X4	4X4	4X6	4X6	4	Not Req'd	Not Req'd					4X6	
	UP TO 10	4X6	4X6	4X6	6X6	6X6	4	8X8	4				4X6		
10 TO 15	UP TO 6	4X6	4X6	4X6	6X6	6X6	4	8X8	4				4X6		
	UP TO 8	4X6	4X6	4X6	6X6	6X6	4	8X8	4				4X6		
	UP TO 10	6X6	6X6	6X6	6X6	6X6	4	8X8	4				4X6		
15 TO 20	UP TO 6	6X6	6X6	6X6	6X6	6X6	4	8X8	4				3X6		
	UP TO 8	6X6	6X6	6X6	6X6	6X6	4	8X8	4				3X6	4X12	
	UP TO 10	6X6	6X6	6X6	6X6	6X6	4	8X10	4				3X6	4X12	
OVER 20	SEE NOTE 1														

\* Douglas fir or equivalent with a bending strength not less than 1500 psi.  
\*\* Manufactured members of equivalent strength may be substituted for wood.

**TABLE N-4**

TIMBER TRENCH SHORING - MINIMUM TIMBER REQUIREMENTS \*  
SOIL TYPE B P<sub>c</sub> - 45 X 11 + 72 psf (1 R. Surcharge)

DEPTH OF TRENCH (FEET)	SIZE (S4S) AND SPACING OF MEMBERS **														
	HORIZ. SPACING (FEET)	CROSS BRACES					WALES		UPRIGHTS						
		UP TO 4	UP TO 6	UP TO 9	UP TO 12	UP TO 15	VERT. SPACING (FEET)	SIZE (IN.)	VERT. SPACING (FEET)	MAXIMUM ALLOWABLE HORIZONTAL SPACING (FEET)					
4 TO 10	UP TO 6	4X6	4X6	4X6	4X6	6X6	5	6X8	5					3X12	4X12
	UP TO 8	4X6	4X6	4X6	6X6	6X6	5	8X8	5				3X8	4X8	
	UP TO 10	4X6	4X6	6X6	6X6	6X8	5	8X10	5				4X8		
10 TO 15	UP TO 6	6X6	6X6	6X6	6X8	6X8	5	8X8	5				3X6	4X10	
	UP TO 8	6X6	6X8	6X8	8X8	8X8	5	10X10	5				3X6	4X10	
	UP TO 10	6X8	6X8	8X8	8X8	8X8	5	10X12	5				3X6	4X10	
15 TO 20	UP TO 6	6X8	6X8	6X8	8X8	8X8	5	8X10	5				4X6		
	UP TO 8	6X8	6X8	6X8	8X8	8X8	5	10X12	5				4X6		
	UP TO 10	8X8	8X8	8X8	8X8	8X8	5	12X12	5				4X6		
OVER 20	SEE NOTE 1														

\* Douglas fir or equivalent with a bending strength not less than 1500 psi.  
\*\* Manufactured members of equivalent strength may be substituted for wood.

**TABLE N-5**

TIMBER TRENCH SHORING - MINIMUM TIMBER REQUIREMENTS \*  
SOIL TYPE C P<sub>c</sub> - 88 X 11 + 72 psf (1 R. Surcharge)

DEPTH OF TRENCH (FEET)	SIZE (S4S) AND SPACING OF MEMBERS **														
	HORIZ. SPACING (FEET)	CROSS BRACES					WALES		UPRIGHTS						
		UP TO 4	UP TO 6	UP TO 9	UP TO 12	UP TO 15	VERT. SPACING (FEET)	SIZE (IN.)	VERT. SPACING (FEET)	MAXIMUM ALLOWABLE HORIZONTAL SPACING (FEET)					
4 TO 10	UP TO 6	6X6	6X6	6X6	6X6	8X8	5	8X8	5				3X6		
	UP TO 8	6X6	6X6	6X6	8X8	8X8	5	10X10	5				3X6		
	UP TO 10	6X6	6X6	8X8	8X8	8X8	5	10X12	5				3X6		
10 TO 15	UP TO 6	6X8	6X8	6X8	8X8	8X8	5	10X10	5				4X6		
	UP TO 8	8X8	8X8	8X8	8X8	8X8	5	12X12	5				4X6		
	UP TO 10	8X8	8X8	8X8	8X8	8X8	5	12X12	5				4X6		
15 TO 20	UP TO 6	8X8	8X8	8X8	8X10	8X10	5	10X12	5				4X6		
	UP TO 8														
	UP TO 10														
OVER 20	SEE NOTE 1														

\* Douglas fir or equivalent with a bending strength not less than 1500 psi.  
\*\* Manufactured members of equivalent strength may be substituted for wood.

**NEW SECTION**

WAC 296-155-66407 APPENDIX D—ALUMINUM HYDRAULIC SHORING FOR TRENCHES. (1) Scope. This appendix contains information that can be used when aluminum hydraulic shoring is provided as a method of protection against cave-ins in trenches that do not exceed 20 feet (6.1m) in depth. This appendix must be used when design of the aluminum hydraulic protective system cannot be performed in accordance with WAC 296-155-657 (3)(b).

(2) Soil Classification. In order to use data presented in this appendix, the soil type or types in which the excavation is made must first be determined using the soil classification method set forth in appendix A of this Part.

(3) Presentation of information. Information is presented in several forms as follows:

(a) Information is presented in tabular form in Tables N-8 through N-11. Each table presents the maximum vertical and horizontal spacings that may be used with various aluminum member sizes and various hydraulic cylinder sizes. Each table contains data only for the particular soil type in which the excavation or portion of the excavation is made. Tables N-8 and N-9 are for vertical shores in Types A and B soil. Tables N-10 and N-11 are for horizontal waler systems in Types B and C soil.

(b) Information concerning the basis of the tabular data and the limitations of the data is presented in subsection (4) of this appendix.

(c) Information explaining the use of the tabular data is presented in subsection (5) of this appendix.

(d) Information illustrating the use of the tabular data is presented in subsection (6) of this appendix.

(e) Miscellaneous notations (footnotes) regarding Table N-8 through N-11 are presented in subsection (7) of this appendix.

(f) Figures, illustrating typical installations of hydraulic shoring, are included just prior to the Tables. The illustrations page is entitled "Aluminum Hydraulic Shoring: Typical Installations."

(4) Basis and limitations of the data.

(a) Vertical shore rails and horizontal wales are those that meet the Section Modulus requirements in the D-1 Tables. Aluminum material is 6061-T6 or material of equivalent strength and properties.

(b) Hydraulic cylinders specifications.

(i) 2-inch cylinders shall be a minimum 2-inch inside diameter with a minimum safe working capacity of no less than 18,000 pounds axial compressive load at maximum extension. Maximum extension is to include full range of cylinder extensions as recommended by product manufacturer.

(ii) 3-inch cylinders shall be a minimum 3-inch inside diameter with a safe working capacity of not less than 30,000 pounds axial compressive load at extensions as recommended by product manufacturer.

(c) Limitation of application.

(i) It is not intended that the aluminum hydraulic specification apply to every situation that may be experienced in the field. These data were developed to apply to the situations that are most commonly experienced in current trenching practice. Shoring systems for use in situations that are not covered by the data in this appendix must be otherwise designed as specified in WAC 296-155-657(3).

(ii) When any of the following conditions are present; the members specified in the Tables are not considered adequate. In this case, an alternative aluminum hydraulic shoring system or other type of protective system must be designed in accordance with WAC 296-155-657.

(A) When vertical loads imposed on cross braces exceed a 100 Pound gravity load distributed on a one foot section of the center of the hydraulic cylinder.

(B) When surcharge loads are present from equipment weighing in excess of 20,000 pounds.

(C) When only the lower portion of a trench is shored and the remaining portion of the trench is sloped or benched unless: The slope portion is sloped at an angle less steep than three horizontal to one vertical; or the members are selected from the tables for use at a depth which is determined from the top of the overall trench, and not from the toe of the sloped portion.

(5) Use of Tables N-8 through N-11. The members of the shoring system that are to be selected using this information are the hydraulic cylinders, and either the vertical shores or the horizontal wales. When a waler system is used the vertical timber sheeting to be used is also selected from these tables. The Tables N-8 and N-9 for vertical shores are used in Type A and B soils that do not require sheeting. Type B soils that may require sheeting, and Type C soils that always require sheeting are found in the horizontal wale Tables N-10 and N-11. The soil type must first be determined in accordance with the soil classification system described in appendix A of this Part. Using the appropriate table, the selection of the size and spacing of the members is made. The selection is based on the depth and width of the trench where the members are to be installed. In these tables the vertical spacing is held constant at four feet on center. The tables show the maximum horizontal spacing of cylinders allowed for each size of wale in the waler system tables, and in the vertical shore tables, the hydraulic cylinder horizontal spacing is the same as the vertical shore spacing.

(6) Example to Illustrate the Use of the Tables:

(a) Example 1: A trench dug in Type A soil is 6 feet deep and 3 feet wide. From Table N-8: Find vertical shores and 2 inch diameter cylinders spaced 8 feet on center (o.c.) horizontally and 4 feet on center (o.c.) vertically. (See Figures N-23 & N-25 for typical installations.)

(b) Example 2: A trench is dug in Type B soil that does not require sheeting, 13 feet deep and 5 feet wide. From Table N-9: Find vertical shores and 2 inch diameter cylinders spaced 6.5 feet o.c. horizontally and 4 feet o.c. vertically. (See Figures N-23 & N-25 for typical installations.)

(c) A trench is dug in Type B soil that does not require sheeting, but does experience some minor raveling of the trench face. The trench is 16 feet deep and 9 feet wide. From Table N-9: Find vertical shores and 2 inch diameter cylinder (with special oversleeves as designated by subdivision (7)(b)) spaced 5.5 feet o.c. horizontally and 4 feet o.c. vertically, plywood (per subdivision (7)(g)) to the N-8 through N-11 Tables) should be used behind the shores. (See Figures N-24 & N-25 for typical installations.)

(d) Example 4: A trench is dug in previously disturbed Type B soil, with characteristics of a Type C soil, and will require sheeting. The trench is 18 feet deep and 12 feet wide. 8 foot horizontal spacing between cylinders is desired for working space. From Table N-10: Find horizontal wale with a section modulus of 14.0 spaced at 4 feet o.c. vertically and 3 inch diameter cylinder spaced at 9 feet maximum o.c. horizontally, 3x12 timber sheeting is required at close spacing vertically. (See Figure N-26 for typical installation.)

(e) Example 5: A trench is dug in Type C soil, 9 feet deep and 4 feet wide. Horizontal cylinder spacing in excess of 6 feet is desired for working space. From Table N-11: Find horizontal wale with a section modulus of 7.0 and 2 inch diameter cylinders spaced at 6.5 feet o.c. horizontally. Or, find horizontal wale with a 14.0 section modulus and 3 inch diameter cylinder spaced at 10 feet o.c. horizontally. Both wales are spaced 4 feet o.c. vertically. 3x12 timber sheeting is required at close spacing vertically. (See Figure N-26 for typical installation.)

(7) Footnotes, and general notes, for Tables N-8 through N-11.

(a) For applications other than those listed in the tables, refer to WAC 296-155-657 (3)(b) for use of manufacturer's tabulated data. For trench depths in excess of 20 feet, refer to WAC 296-155-657 (3)(b) and (c).

(b) 2 inch diameter cylinders, at this width, shall have structural steel tube (3.5x3.5x0.1875) oversleeves, or structural oversleeves of manufacturer's specification, extending the full, collapsed length.

(c) Hydraulic cylinders capacities.

(i) 2 inch cylinders shall be a minimum 2-inch inside diameter with a safe working capacity of not less than 18,000 pounds axial compressive load at maximum extension. Maximum extension is to include full range of cylinder extensions as recommended by product manufacturer.

(ii) 3-inch cylinders shall be a minimum 3-inch inside diameter with a safe work capacity of not less than 30,000 pounds axial compressive load at maximum extension. Maximum extension is to include full range of cylinder extensions as recommended by product manufacturer.

(d) All spacing indicated is measured center to center.

(e) Vertical shoring rails shall have a minimum section modulus of 0.40 inch.

(f) When vertical shores are used, there must be a minimum of three shores spaced equally, horizontally, in a group.

(g) Plywood shall be 1.125 in. thick softwood or 0.75 inch thick, 14 ply, arctic white birch (Finland form). Please note that plywood is not intended as a structural member, but only for prevention of local raveling (sloughing of the trench face) between shores.

(h) See appendix C for timber specifications.

(i) Wales are calculated for simple span conditions.

(j) See subsection (4) of this appendix, for basis and limitations of the data.

ALUMINUM HYDRAULIC SHORING  
TYPICAL INSTALLATIONS

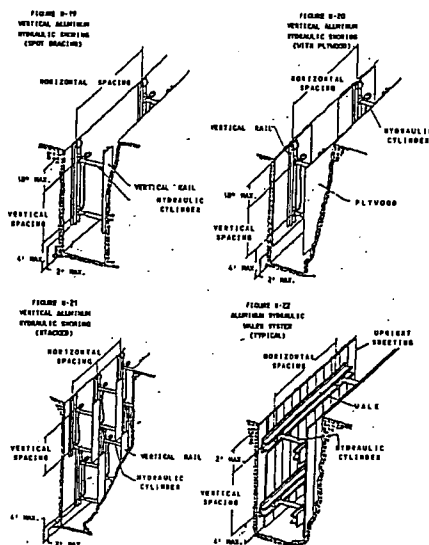

**TABLE N-8**  
ALUMINUM HYDRAULIC SHORING  
VERTICAL SHORES  
FOR SOIL TYPE A

Depth of Trench (Feet)	Maximum Horizontal Spacing (Feet)	Maximum Vertical Spacing (Feet)	Hydraulic Cylinders		
			Width of Trench (Feet)		
			Up to 8	Over 8 Up to 12	Over 12 Up to 15
Over 4 Up to 10	8	4	2 INCH DIAMETER	2 INCH DIAMETER NOTE (2)	3 INCH DIAMETER
Over 10 Up to 15	8				
Over 15 Up to 20	7				
Over 20	NOTE (1)				

Footnotes to tables, and general notes on hydraulic shoring, are found in Appendix D, WAC 296-155-66407(7)  
 Note (1): See Appendix D, WAC 296-155-66407(7)(a)  
 Note (2): See Appendix D, WAC 296-155-66407(7)(b)

**TABLE N-9**  
ALUMINUM HYDRAULIC SHORING  
VERTICAL SHORES  
FOR SOIL TYPE B

Depth of Trench (Feet)	Maximum Horizontal Spacing (Feet)	Maximum Vertical Spacing (Feet)	Hydraulic Cylinders		
			Width of Trench (Feet)		
			Up to 8	Over 8 Up to 12	Over 12 Up to 15
Over 4 Up to 10	8	4	2 INCH DIAMETER	2 INCH DIAMETER NOTE (2)	3 INCH DIAMETER
Over 10 Up to 15	6.5				
Over 15 Up to 20	5.5				
Over 20	NOTE (1)				

Footnotes to tables, and general notes on hydraulic shoring, are found in Appendix D, WAC 296-155-66407(7)  
 Note (1): See Appendix D, WAC 296-155-66407(7)(a)  
 Note (2): See Appendix D, WAC 296-155-66407(7)(b)

**TABLE N-10**  
ALUMINUM HYDRAULIC SHORING  
WALER SYSTEMS  
FOR SOIL TYPE B

Depth of Trench (Feet)	Wales	Section Modulus (In <sup>3</sup> )	Hydraulic Cylinders						Timber Uprights		
			Width of Trench (Feet)						Max. Horizontal Spacing (See Notes)		
			Up to 8		Over 8 Up to 12		Over 12 Up to 15		Solid Sheet	2 Feet	3 Feet
Over 4 Up to 10	4	3.5	8.0	2 IN	8.0	2 IN	8.0	3 IN			3 X 12
			9.0	2 IN	9.0	2 IN	9.0	3 IN			
			12.0	3 IN	12.0	3 IN	12.0	3 IN			
Over 10 Up to 15	4	3.5	6.0	2 IN	6.0	2 IN	6.0	3 IN		3 X 12	
			8.0	3 IN	8.0	3 IN	8.0	3 IN			
			10.0	3 IN	10.0	3 IN	10.0	3 IN			
Over 15 Up to 20	4	3.5	5.5	2 IN	5.5	2 IN	5.5	3 IN			
			7.0	3 IN	7.0	3 IN	7.0	3 IN	3 X 12		
			9.0	3 IN	9.0	3 IN	9.0	3 IN			
Over 20		NOTE (1)									

Footnotes to tables, and general notes on hydraulic shoring, are found in Appendix D, WAC 296-155-66407(7)  
 Note (1): See Appendix D, WAC 296-155-66407(7)(a)  
 Note (2): See Appendix D, WAC 296-155-66407(7)(b)  
 \*Consult product manufacturer and/or qualified engineer for Section Modulus of available wales.

**TABLE N-11**  
ALUMINUM HYDRAULIC SHORING  
WALER SYSTEMS  
FOR SOIL TYPE C

Depth of Trench (Feet)	Wales	Vertical Spacing (Feet)	Section Modulus (In <sup>3</sup> )	Hydraulic Cylinders						Timber Uprights		
				Width of Trench (Feet)						Max. Horizontal Spacing (See Notes)		
				Up to 8		Over 8 Up to 12		Over 12 Up to 15		Solid Sheet	2 Feet	3 Feet
Over 4 Up to 10	4	4	3.5	6.0	2 IN	6.0	2 IN	6.0	3 IN			
				7.0	2 IN	7.0	2 IN	7.0	3 IN	3 X 12		
				10.0	3 IN	10.0	3 IN	10.0	3 IN			
Over 10 Up to 15	4	4	3.5	4.0	2 IN	4.0	2 IN	4.0	3 IN			
				5.5	3 IN	5.5	3 IN	5.5	3 IN	3 X 12		
				8.0	3 IN	8.0	3 IN	8.0	3 IN			
Over 15 Up to 20	4	4	3.5	3.5	2 IN	3.5	2 IN	3.5	3 IN			
				5.0	3 IN	5.0	3 IN	5.0	3 IN	3 X 12		
				6.0	3 IN	6.0	3 IN	6.0	3 IN			
Over 20			NOTE (1)									

Footnotes to tables, and general notes on hydraulic shoring, are found in Appendix D, WAC 296-155-66407(7)  
 Note (1): See Appendix D, WAC 296-155-66407(7)(a)  
 Note (2): See Appendix D, WAC 296-155-66407(7)(b)  
 \*Consult product manufacturer and/or qualified engineer for Section Modulus of available wales.

**NEW SECTION**

**WAC 296-155-66409 APPENDIX E—ALTERNATIVES TO TIMBER SHORING.**

Figure N-23, Aluminum Hydraulic Shoring

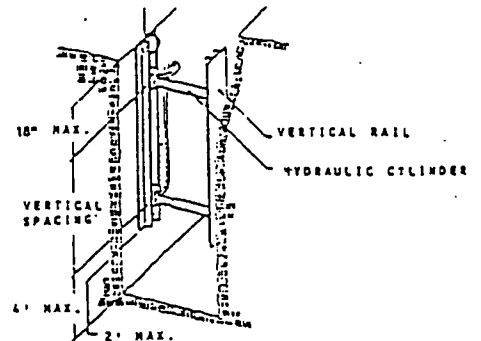

Figure N-24, Pneumatic/hydraulic Shoring

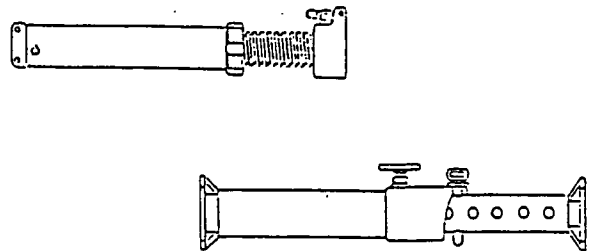

Figure N-25, Trench Jacks (Screw Jacks)

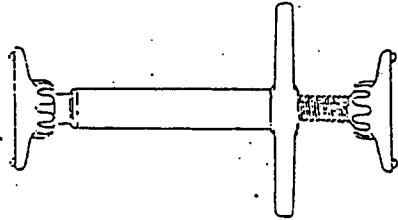

Figure N-26, Trench Shields

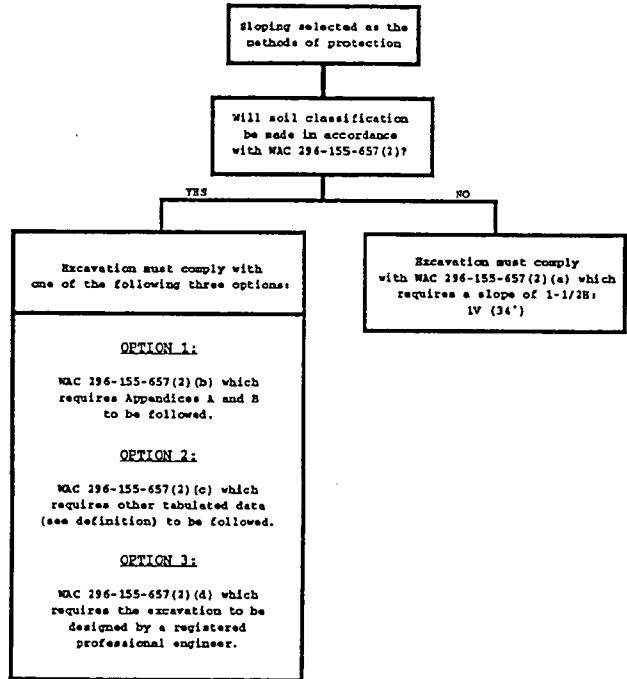
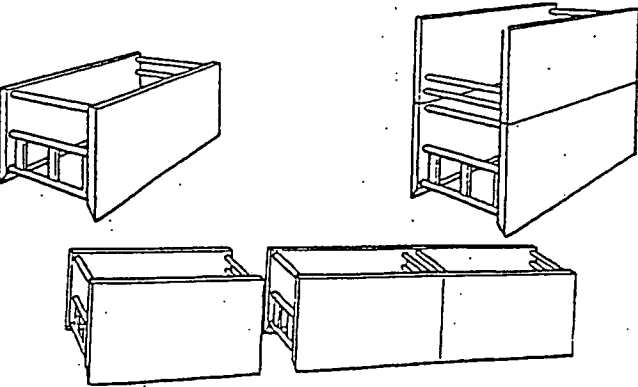

FIGURE N-28 - SLOPING OPTIONS

**NEW SECTION**

WAC 296-155-66411 APPENDIX F—SELECTION OF PROTECTIVE SYSTEMS. The following figures are a graphic summary of the requirements contained in part N for excavations 20 feet or less in depth. Protective systems for use in excavations more than 20 feet in depth must be designed by a registered professional engineer in accordance with WAC 296-155-657 (2) and (3).

Appendix F to Part N -- Selection of Protective Systems

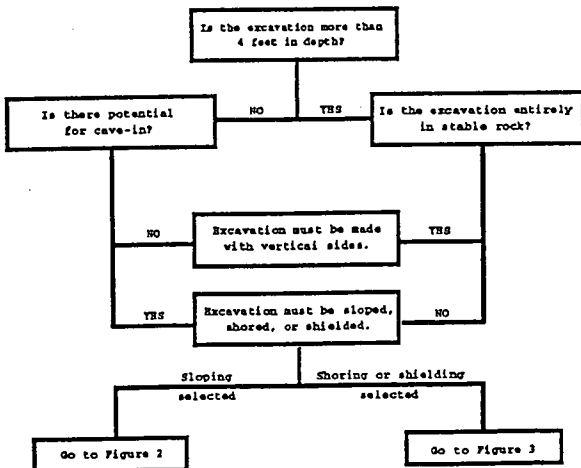

FIGURE N-27 - PRELIMINARY DECISIONS

Shoring or shielding selected as the method of protection.

Soil classification is required when shoring or shielding is used. The excavation must comply with one of the following four options:

**OPTION 1:**

WAC 296-155-657(3)(a) which requires Appendices A and C to be followed (e.g., timber shoring)

**OPTION 2:**

WAC 296-155-657(3)(b) which requires manufacturers data to be followed (e.g., hydraulic shoring, trench jacks, air shores, shields)

**OPTION 3:**

WAC 296-155-657(3)(c) which requires tabulated data (see definition) to be followed (e.g., any system as per the tabulated data).

**OPTION 4:**

WAC 296-155-657(3)(d) which requires the excavation to be designed by a registered professional engineer (e.g., any designed system).

(6) Jacks/lifting units shall have a safety device installed which will cause the jacks/lifting units to support the load in any position in the event any jack/lifting unit malfunctions or loses its lifting ability.

(7) Jacking operations shall be synchronized in such a manner to ensure even and uniform lifting of the slab. During lifting, all points at which the slab is supported shall be kept within 1/2 inch of that needed to maintain the slab in a level position.

(8) If leveling is automatically controlled, a device shall be installed that will stop the operation when the 1/2 inch tolerance set forth in subsection (7) of this section is exceeded or where there is a malfunction in the jacking (lifting) system.

(9) If leveling is maintained by manual controls, such controls shall be located in a central location and attended by a competent person while lifting is in progress. In addition to meeting the definition in WAC 296-155-012(4), the competent person must be experienced in the lifting operation and with the lifting equipment being used.

(10) The maximum number of manually controlled jacks/lifting units on one slab shall be limited to a number that will permit the operator to maintain the slab level within specified tolerances of subsection (7) of this section, but in no case shall that number exceed 14.

(11) No employee, except those essential to the jacking operation, shall be permitted in the building/structure while any jacking operation is taking place unless the building/structure has been reinforced sufficiently to ensure its integrity during erection. The phrase "reinforced sufficiently to ensure its integrity" used in this subsection means that a registered professional engineer, independent of the engineer who designed and planned the lifting operation, has determined from the plans that if there is a loss of support at any jack location, that loss will be confined to that location and the structure as a whole will remain stable.

(a) Under no circumstances, shall any employee who is not essential to the jacking operation be permitted immediately beneath a slab while it is being lifted.

(b) For the purpose of subsection (11) of this section, a jacking operation begins when a slab or group of slabs is lifted and ends when such slabs are secured (with either temporary connections or permanent connections).

(c) Employers who comply with Appendix A to WAC 296-155-694 shall be considered to be in compliance with the provisions of subsections (11) through (11)(c) of this section.

(12) When making temporary connections to support slabs, wedges shall be secured by tack welding, or an equivalent method of securing the wedges to prevent them from falling out of position. Lifting rods may not be released until the wedges at that column have been secured.

(13) All welding on temporary and permanent connections shall be performed by a certified welder, familiar with the welding requirements specified in the plans and specifications for the lift-slab operation.

(14) Load transfer from jack/lifting units to building columns shall not be executed until the welds on the column shear plates (weld blocks) are cooled to air temperature.

(15) Jacks/lifting units shall be positively secured to building columns so that they do not become dislodged or dislocated.

(16) Equipment shall be designed and installed so that the lifting rods cannot slip out of position or the employer shall institute other measures, such as the use of locking or blocking devices, which will provide positive connection between the lifting rods and attachments and will prevent components from disengaging during lifting operations.

Appendix to WAC 296-155-694—Lift-slab operations (This appendix is nonmandatory.)

In WAC 296-155-694(11), WISHA requires employees to be removed from the building/structure during jacking operations unless an independent registered professional engineer, other than the engineer who designed and planned the lifting operation, has determined that the building/structure has been sufficiently reinforced to insure the integrity of the building/structure. One method to comply with this provision is for the employer to ensure that continuous bottom steel is provided in every slab and in both directions through every wall or column head area. (Column head area means the distance between lines that are one and one half times the thickness of the slab or drop panel. These lines are located outside opposite faces of the outer edges of the shearhead sections—See Figure 1.) The amount of bottom steel shall be established by assuming loss of support at a given lifting jack and then determining the steel necessary to carry, by catenary action over the span between surrounding supports, the slab service dead load

FIGURE N-29 - SHORING AND SHIELDING OPTIONS

AMENDATORY SECTION (Amending Order 91-01, filed 5/20/91, effective 6/20/91)

WAC 296-155-694 REQUIREMENTS FOR LIFT-SLAB CONSTRUCTION OPERATIONS. (1) Lift-slab operations shall be designed and planned by a registered professional engineer who has experience in lift-slab construction. Such plans and designs shall be implemented by the employer and shall include detailed instructions and sketches indicating the prescribed method of erection. These plans and designs shall also include provisions for ensuring lateral stability of the building/structure during construction.

(2) Jacks/lifting units shall be marked to indicate their rated capacity as established by the manufacturer.

(3) Jacks/lifting units shall not be loaded beyond their rated capacity as established by the manufacturer.

(4) Jacking equipment shall be capable of supporting at least two and one-half times the load being lifted during jacking operations and the equipment shall not be overloaded. For the purpose of this provision, jacking equipment includes any load bearing component which is used to carry out the lifting operation(s). Such equipment includes, but is not limited to, the following: Threaded rods, lifting attachments, lifting nuts, hook-up collars, T-caps, shearheads, columns, and footings.

(5) Jacks/lifting units shall be designed and installed so that they will neither lift nor continue to lift when they are loaded in excess of their rated capacity.



plus any service dead and live loads likely to be acting on the slab during jacking. In addition, the surrounding supports must be capable of resisting any additional load transferred to them as a result of the loss of support at the lifting jack considered.

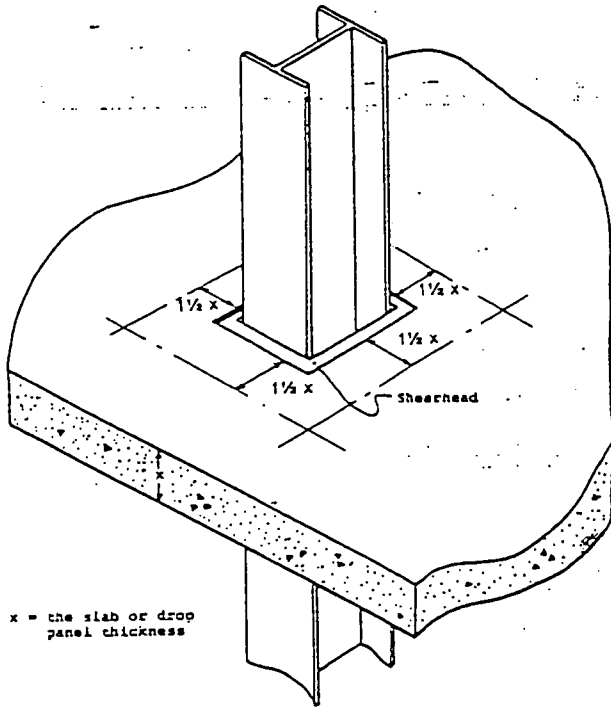

Figure 1—Column Head Area

**WSR 92-15-147A**  
**PROPOSED RULES**  
**DEPARTMENT OF REVENUE**  
 [Filed July 22, 1992, 11:21 a.m.]

Continuance of WSR 92-03-067.

Title of Rule: Amending WAC 458-20-164, Insurance agents, brokers and solicitors.

Purpose: To implement chapter 275, Laws of 1991, which expands the definition of "employee" under RCW 82.04.360 to include full-time life insurance agents and to delete the provisions of the existing rule concerning the taxability of commissions earned on insurance policies covering public bodies.

Statutory Authority for Adoption: RCW 82.32.300.

Statute Being Implemented: Title 82 RCW.

Summary: To expand the definition of "employee" to include full-time life insurance agents for purposes of the exemption from the B&O tax provided in RCW 82.04.360 and the amendment deletes provisions of the rule that permit the division of commissions by agreement among brokers and the insured when the commissions are on policies of insurance of public bodies.

Reasons Supporting Proposal: To clarify the taxability of insurance agents, brokers and solicitors.

Name of Agency Personnel Responsible for Drafting: Robert Heller, 711 Capitol Way, #205, Olympia, (206) 753-1971; Implementation: Les Jaster, 711 Capitol

Way, #205, Olympia, (206) 586-7150; and Enforcement: Russ Brubaker, 711 Capitol Way, #303, Olympia, (206) 586-0257.

Name of Proponent: Department of Revenue, governmental.

Rule is not necessitated by federal law, federal or state court decision.

Explanation of Rule, its Purpose, and Anticipated Effects: The rule provides tax reporting information for insurance agents, brokers and solicitors. The rule clarifies the meaning of gross income of an insurance agent, broker or solicitor and clarifies when a full-time life insurance salesperson will be treated as an employee under the business and occupation tax. In addition, the changes to the rule clarify that payments made by a taxpayer to an associate in connection with the rendering of services by the taxpayer are costs of doing business and are generally not deductible under the business and occupation tax. The changes delete language from the rule which could lead taxpayers to the conclusion that professional expenses incurred by an agent, broker or solicitor in placing insurance with public bodies are deductible.

Proposal does not change existing rules.

No small business economic impact statement is required for this proposal by chapter 19.85 RCW.

The Department of Revenue has reviewed administrative provisions contained in this rule in order to lessen the economic impact on small businesses. A small business economic impact statement is not required for the following reason: To the best of our knowledge, there is no economic administrative impact on any small business as a result of this rule amendment.

Hearing Location: Evergreen Plaza Building, 2nd Floor Conference Room, 711 Capitol Way South, Olympia, WA, on August 27, 1992, at 10:00 a.m.

Submit Written Comments to: Robert Heller, Counsel, Department of Revenue, P.O. Box 47458, FAX (206) 586-7603, Olympia, WA 98504-7458, by August 27, 1992.

Date of Intended Adoption: September 3, 1992.

July 22, 1992

Russell W. Brubaker  
 Legislative and Policy Manager

**AMENDATORY SECTION** (Amending Order ET 83-6, filed August 23, 1983)

**WAC 458-20-164 INSURANCE AGENTS, BROKERS AND SOLICITORS.** (1) introduction. This section explains the taxability of amounts received by insurance agents, brokers, or solicitors.

(2) definition. The words "agent," "broker," and "solicitor(;;)" ((as used herein mean respectively,)) mean a person licensed as such under the provisions of chapter 48.17 RCW.

(3) Business and occupation tax. Every person engaging in business as an insurance (acting in the capacity of) agent, broker, or solicitor ((is presumed to be engaging in business and)) is taxable under the insurance agents and brokers classification upon the gross income of the business. ((unless such person is a bona fide employee. The burden is upon such person to establish the fact of his status as an employee. (Sec WAC 458-20-105 Employees.) Gross income of the business is determined by the amount of gross commissions received or retained, not by the gross premiums paid by the insured.

The term "gross income of the business" includes gross income from commissions, fees or other emoluments however designated which the agent, broker, or solicitor receives or becomes entitled to receive but does not include amounts held in trust for the insurer or the client. (See also WAC 458-20-111 - Advances and reimbursements.)

No deduction is allowed for commissions, fees, or salaries paid to other agents, brokers, or solicitors nor for other expenses of doing business.)

(a) The gross income of the business is determined by the amount of gross commissions received, not by the gross premiums paid by the insured. The term "gross income of the business" include gross receipts from commissions, fees or other amounts which the agent, broker, or solicitor receives or becomes entitled to receive. The gross income of the business does not include amounts held in trust for the insurer or the client. (See also WAC 458-20-111 - Advances and reimbursements.)

(b) No deduction is allowed for commissions, fees, or salaries paid to other agents, brokers, or solicitors nor for other expenses of doing business.

(c) Every person acting in the capacity of agent, broker, or solicitor is presumed to be engaging in business and subject to the business and occupation tax unless such person can demonstrate he or she is a bona fide employee. The burden is upon such person to establish the fact of his or her status as an employee. (See WAC 458-20-105 Employees.)

(4) Full-time life insurance salespersons. After June 30, 1991, persons who sell life insurance on a full-time basis, as provided in section 3121 (d)(3)(B) of the Internal Revenue Code (statutory employee), will be considered employees. Such persons will not be subject to the business and occupation tax on amounts received in their capacity as statutory employees.

(a) For purposes of this subsection (4), a full-time life insurance salesperson is an individual who meets all of the following criteria:

(i) the person's principal business activity is devoted to the solicitation of life insurance or annuity contracts, or both, primarily for one insurance company;

(ii) the contract between the individual and the primary life insurance company contemplates that substantially all of such services are to be performed personally by such individual;

(iii) the individual does not have a substantial investment in facilities used in connection with the sale of life insurance or annuity contracts (other than in facilities for transportation); and

(iv) the sale of life insurance by such individual occurs in the course of a continuing relationship with the primary life insurance company.

(b) A person's principal business activity is the activity from which he or she generally receives the greatest remuneration. All business activities, including acting as an employee, will be considered in determining a person's principal business activity.

(c) The facilities referred to in subsection (4)(a)(ii) include such things as office space, office equipment and secretarial services. The term facilities does not include such tools, instruments or clothing as are commonly furnished by employees. An investment is substantial if a deduction for the item is taken in calculating the person's federal income tax liability.

(d) Failure to satisfy any one of the criteria listed in subsection (4)(a) will disqualify a person from treatment as an employee under subsection (4).

(e) A person will be considered an employee under this subsection (4) only as to amounts received as compensation for the sale of life insurance or annuity contracts, or both, from one life insurance company, regardless of whether the person sells life insurance on behalf of other companies.

(f) A person will be presumed to be a full-time life insurance salesperson within the meaning of section 3121 (d)(3)(B) of the Internal Revenue Code if they receive a Form W-2 (federal income tax wage and tax statement) indicating that they are a statutory employee. A person receiving a W-2 as a statutory employee will be presumed to be an employee under this subsection only as to amounts reported on the W-2 as compensation for the sale of life insurance.

(g) A person who does not receive a properly marked W-2 has the burden of establishing that they are a full-time life insurance salesperson as provided in (a) of this subsection.

(h) Examples.

(i) A person sells life insurance on a full-time basis on behalf of one company. The company issues a Form W-2 which indicates that the person is a statutory employee. Under these circumstances, the person will be presumed an employee as to amounts reported on the Form W-2 as compensation for the sale of life insurance and will not be taxable under the business and occupation on such amounts.

(ii) A person sells insurance behalf of several insurance companies two of which are life insurance companies and the others are casualty insurance companies. The person sells both life insurance and casualty

insurance. One of the life insurance companies issues a Form W-2 indicating that the person is a statutory employee. The person will be presumed an employee as to amounts reported on the Form W-2 as compensation for the sale of life insurance and will not be taxable under the business and occupation tax on such amounts.

(iii) A person sells life insurance on behalf of several life insurance companies and does not engage in any other business activity. Most of the policies sold by the person are written with one company. The person does not receive a Form W-2 from any of the companies for which life insurance is sold. The person's sales activities are conducted from an office which he or she leases. The office lease payments are deducted by the salesperson in computing his or her federal income tax liability. In addition, the sales person has an employee whose salary is also deducted for federal income tax purposes. Because the person does not receive a Form W-2, he or she will not be presumed to be an employee. Instead, the person has the burden of proving the existence of each of the criteria listed in subsection (4)(a) of this section. In this example, the salesperson will not be considered an employee under this subsection (4) because they have a substantial investment in facilities.

(Where an insurance association, licensed as a broker, agent or solicitor negotiates with a public body for the placement of its insurance coverage and arranges for the servicing of such insurance through a broker, agent or solicitor and there is an agreement between the association and the broker, agent or solicitor and the prospective insured that the commission on the policy premium will be shared, the entity receiving the commission need only include in gross income its share of the commission. It need not include in gross income the portion of the commission earned by the other broker, agent and/or solicitor nor need the other broker, agent and/or solicitor include in gross income the portion retained by the entity which first receives payment:  
(For tax liability of insurance adjusters, see WAC 458-20-212.))

(5) Special classification for certain managing general agents. Under RCW 82.04.280(5) persons representing and performing services for fire or casualty insurance companies as independent resident managing general agents are subject to tax at the prevailing rate upon the gross income of the business.

(a) In view of the small number of persons falling in this special category, no separate classification line on the combined excise tax return (Form 2406) has been provided for reporting this income; it should be shown on line 1 of the combined excise tax return with the explanatory note: "Income for insurance managing general agent taxable under RCW 82.04.280(5)."

(b) Any person claiming to fall within this tax classification must demonstrate:

(i) ((+)) That he is licensed as a resident general agent by the insurance commissioner; and

(ii) ((+)) That he performs the following independent manager functions:

(aa) ((+)) Pays all sales and/or production expense; including salaries of special field representatives, underwriters, and inspectors as well as all office expenses of rent, supplies, secretarial help, etc.

(bb) ((+)) Bills all premiums for the company so represented.

(cc) ((+)) Directly contracts for or hires all selling agents.

(dd) ((+)) Exercises final responsibility with respect to selecting risks and underwriting matters.

(ee) ((+)) Makes all arrangements for reinsurance.

(ff) ((+)) Handles all claims adjustments directly with the insured (by his own staff or through hiring an independent adjuster).

(c) Persons wishing to claim qualification for this special insurance agent classification should request application forms from the department of revenue ((to make application therefor)).

((Revised December 12, 1968.))

## WSR 92-15-148

### PROPOSED RULES

### DEPARTMENT OF HEALTH

[Filed July 22, 1992, 11:26 a.m.]

Original Notice.

Title of Rule: WAC 246-924-355 Rules of ethical conduct, rules for professional conduct of licensed psychologists.

**Purpose:** Outline rules of conduct for licensed psychologists.

**Statutory Authority for Adoption:** RCW 18.83.050(5).

**Statute Being Implemented:** Chapter 18.83 RCW.

**Summary:** These rules will establish guidelines on areas including retention of records, confidentiality, relationships, supervision and rendering psychological services.

**Name of Agency Personnel Responsible for Drafting, Implementation and Enforcement:** Terry J. West, 1300 S.E. Quince Street, Mailstop 7868, Olympia, WA, 98504, 753-3095.

**Name of Proponent:** Examining Board of Psychology, governmental.

**Rule is not necessitated by federal law, federal or state court decision.**

**Explanation of Rule, its Purpose, and Anticipated Effects:** These rules of ethical conduct will clearly spell out the legal and ethical expectations for licensed psychologists which will ensure quality care and protection of the public.

**Proposal Changes the Following Existing Rules:** Updates code of ethics to reflect current thinking and fully spells out requirements for ethical conduct.

No small business economic impact statement is required for this proposal by chapter 19.85 RCW.

**Hearing Location:** Sea-Tac Airport Hilton, 17620 Pacific Highway South, SeaTac, WA 98188, Peninsula West Room, on September 11, 1992, at 1:30 p.m.

**Submit Written Comments to:** Terry J. West, Program Manager, 1300 S.E. Quince Street, Mailstop 7868, Olympia, WA 98504-7868, by September 7, 1992.

**Date of Intended Adoption:** September 11, 1992.

July 16, 1992

Dave Gossett, Chair  
Examining Board of Psychology

#### NEW SECTION

WAC 246-924-355 RULES OF ETHICAL CONDUCT. (1) Rules of ethical conduct

(a) Purpose. The rules of ethical conduct constitute the standards for ethical professional practice of a psychologist.

(b) Scope. The psychologist shall be governed by these rules of conduct whenever providing psychological services in any context. These rules of conduct shall apply to the conduct of all licensees and applicants.

(c) Responsibility for own actions. The psychologist shall be fully responsible for his/her own professional decisions and professional actions.

#### (2) Definitions.

(a) Client. "Client means a recipient of psychological services or that person's legal guardian. A corporate entity or other organization can be a client when the professional contract is to provide services of primary benefit to the organization rather than to individuals.

(b) Confidential client information. "Confidential client information" means information revealed by the client or otherwise obtained by a psychologist, where there is reasonable expectation, because of the relationship between the client and the psychologist, or the circumstances under which the information was revealed or obtained, that the information was private. (The information shall not be disclosed by the psychologist without the informed written consent of the client(s). When a corporation or other organization is the client, rules of confidentiality apply to information pertaining to the organization, including personal information about clients when obtained in the proper course of that contract. Such information about clients is subject to confidential control of the organization, not of the individual, and can

be made available to the organization, individual, and can be made available to the organization, unless there is reasonable expectation by such individual that such information was obtained in a separate professional relationship with that individual and is therefore subject to confidentiality requirements in itself.)

(c) Supervisee. "Supervisee" means any person who functions under the extended authority of the psychologist to provide psychological services, such as auxiliary staff as defined in WAC 246-924-030(2), or any person who is in training and provides psychological services.

#### (3) Competence

(a) Limits on practice. The psychologist shall limit practice to the areas in which he/she is competent.

(b) Referral. The psychologist shall refer to other health care resources, legal authorities or social service agencies when such referral is in the best interest of the client.

#### (4) Maintenance and retention of records.

(a) The psychologist rendering professional services to a client or clients or rendering services billed to a third party payor, shall document services except as provided in (vii) that documentation shall include:

(i) The presenting problems(s), purpose or diagnosis

(ii) The fee arrangement

(iii) The date and service provided

(iv) A copy of all tests and evaluative reports prepared

(v) Notation and results of formal consults with others, providers, including information obtained from other persons or agencies through a release of information

(vi) Progress notes reflecting on-going treatment and current status.

(vii) A client may request that no records be kept. This request must be in writing in which case, only the following will be retained.

A.) identity of the recipient of services

B.) service dates and fees

C.) description of services

D.) written request that no records be kept

(b) The psychologist shall not be subject to disciplinary action for failure to retain the records described in (a) after five years from the date of last service, to age 18 if the client is a minor, or the time period required by other regulations whichever is longer. This record retention requirement does not create a legal defense or cause of action in any legal proceeding other than a disciplinary proceeding for failure to retain the records described in (a) of this rule. The psychologist may wish to consult with an attorney for advice on legal requirements for record retention.

(5) Continuity of care. The psychologist shall make arrangements to deal with emergency needs of her/his clients during periods of anticipated absences from the psychologist's routine professional availability.

#### (6) Impaired Objectivity and Dual Relationships.

(a) The psychologist shall not undertake or continue a professional relationship with a client when the competency of the psychologist is or could reasonably be expected to be impaired due to mental, emotional, physiologic, pharmacologic, or substances abuse conditions. If such a condition develops after a professional relationship has been initiated, the psychologist shall terminate the relationship in an appropriate manner, shall notify the client in writing of the termination, and shall assist the client in obtaining services from another professional.

(b) The psychologist shall not undertake or continue a professional relationship with a client when the objectivity or competency of the psychologist is or could reasonably be expected to be impaired because of the psychologist's present or previous familial, social, sexual, emotional, financial, supervisory, political, administrative, or legal relationship with the client or a relevant person associated with or related to the client. If such dual relationship develops or is discovered after the professional relationship has been initiated, the psychologist shall terminate the professional relationship in an appropriate manner, shall notify the client in writing of this termination, and shall assist the client in obtaining services from another professional.

(c) The psychologist shall not engage in sexual contact, physical intimacies, or sexually seductive, demeaning, or harassing behavior with clients.

(d) The psychologist shall not engage in sexual contact, physical intimacies, or sexually seductive, demeaning, or harassing behavior with former clients if such contact or behavior involves the abuse of the psychologist-client relationship.

#### (7) Client Welfare

(a) Providing explanation of procedures. The psychologist shall upon request give a truthful, understandable, and reasonably complete account of the client's condition to the client or to those responsible for

the care of the client. The psychologist shall keep the client fully informed as to the purpose and nature of any evaluation, treatment, or other procedures, and of the client's right to freedom of choice regarding services provided.

(b) Termination of services. Whenever professional services are terminated, the psychologist shall offer to help locate alternative sources of professional services or assistance if necessary. The psychologist shall terminate a professional relationship when the psychologist knows or could be reasonably expected to know that the client is not benefiting and is not likely to benefit in the future from the relationship.

(c) Stereotyping. The psychologist shall not impose on the client any stereotypes of behavior, values, or roles related to age, gender, religion, race, disability, nationality, or sexual preference which would interfere with the objective provision of psychological services to the client.

(d) Solicitation of business by clients. The psychologist shall not request or induce any client, who is not an organization, to solicit business on behalf of the psychologist.

(e) Referrals on request. The psychologist shall make an appropriate referral of the client to another professional when requested to do so by the client. The referral shall be in the best interest of the client and not economically motivated.

(8) Welfare of Supervisees and Research Subjects

(a) Welfare of students and supervisees. The psychologist shall not exploit a student or supervisee sexually, financially or otherwise.

(b) Welfare of research subjects. The psychologist shall respect the dignity and protect the welfare of his/her research subjects, and shall comply with all relevant statutes and administrative rules concerning treatment of research subjects.

(9) Protecting Confidentiality of Clients.

(a) In general. The psychologist shall safeguard the confidential information obtained in the course of practice, teaching, research, or other professional duties. With the exceptions set forth below, the psychologist shall disclose confidential information to others only with the informed written consent of the client.

(b) Disclosure without informed written consent. The psychologist may disclose confidential information without the informed written consent of the client only in compliance with the Uniform Health Care Information Act, Chapter RCW 70.02.

(c) Services involving more than one interested party. In a situation in which more than one party has a legally recognized interest in the professional services rendered by the psychologist to a recipient, the psychologist shall, to the extent possible, clarify to all parties, in writing, prior to rendering the services the dimensions of confidentiality and professional responsibility that shall pertain in the rendering of services. Such clarification is specifically indicated, among other circumstances, when the client is an organization.

(d) Legally dependent clients. At the beginning of a professional relationship, to the extent that the client can understand, the psychologist shall inform a client who is under the age of fourteen or who has a legal guardian of the limit the law imposes on the right of confidentiality with respect to his/her communications with the psychologist. Clients between the age of fourteen and eighteen shall have the right of confidentiality and privilege.

(e) Limited access to client records. The psychologist shall limit access to client records and shall assure that all persons working under his/her authority comply with the requirements for confidentiality of client material.

(f) When rendering psychological services as part of a team which includes non-health care professionals, if the psychologist shares confidential information about the client when so authorized by the client, the psychologist shall advise all persons receiving the information from the psychologist that the information should be maintained in a confidential manner.

(g) Reporting of abuse of children and vulnerable adults. The psychologist shall comply with RCW 26.44.

(h) Observation and electronic recording. The psychologist shall obtain documented informed consent of the client for observed or electronically recorded sessions.

(i) Disguising confidential information. When case reports or other confidential information is used as the basis of teaching, research, or other published reports, the psychologist shall exercise reasonable care to insure that the reported material is appropriately disguised to prevent client identification.

(j) Confidentiality if client is deceased. The psychologist shall comply with the Uniform Health Care Information Act Chapter 70.02.

(k) Confidentiality after termination of professional relationship. The psychologist shall continue to treat, information regarding a client as confidential after the professional relationship between the psychologist and the client has ceased.

(10) Representation of Services.

Representation of services includes public statements and representations announcing or advertising the availability of psychological products, publications, or services. It includes, but is not limited to, communication by means of periodical, book, list, directory, television, radio, video, or motion picture.

(11) Fees. (a) Disclosure of cost of services. The psychologist shall not mislead or withhold from the client, a prospective client, or third party payor, information about the cost of his/her professional services.

(b) Reasonableness of fee. The psychologist shall not exploit the client or responsible payor by charging a fee that is excessive for the services performed or by entering into an exploitive bartering arrangement in lieu of a fee.

(12) Assessment Procedures.

(a) Communication of results. The psychologist shall accompany communication of assessment procedures and test results, including automated test results to the client, parents, legal guardians or other agents of the client by appropriate interpretive aids and explanations.

(b) Reservations concerning results. The psychologist shall include in his/her report of the results of an assessment procedure any deficiencies of the assessment norms for the individual assessed and any relevant reservations or qualifications which affect the validity, reliability, or other interpretation of results.

(c) Protection of integrity of assessment procedures. The psychologist shall not reproduce or describe in popular publications, lectures or public presentations psychological tests or other assessment devices in ways that might invalidate them.

(d) Release of test materials. The psychologist shall not release test materials or raw test data to persons not trained in test assessment procedures and interpretation except as authorized by the Uniform Health Care Information Act, Chapter 70.02.

(e) Advertising newly developed procedures. Information for professional users. The psychologist advertising for sale a newly developed assessment procedure or automated interpretation service to other professionals shall provide or make available a manual or other printed material which fully describes the development of the assessment procedure or service, the rationale, evidence of validity and reliability, and characteristics of the normative population. The psychologist shall explicitly state the purpose and application for which the procedure is recommended and identify special qualifications required to administer and interpret it properly. The psychologist shall ensure that the advertisements for the assessment procedure or interpretive service are factual and descriptive.

(13) Fraud, misrepresentation, or deception. The psychologist shall not use fraud, misrepresentation, or deception in obtaining a psychology license, in passing a psychology licensing examination, in assisting another to obtain a psychology license or to pass a psychology licensing examination, in billing clients or third party payors, in providing psychological service, in reporting the results of psychological evaluations or services, or in conducting any other activity related to the practice of psychology.

(14) Aiding Illegal Practice

(a) Aiding unauthorized practice. The psychologist shall not aid or abet another person in misrepresenting his/her professional credentials or in illegally engaging in the practice of psychology.

(b) Delegating professional responsibility. The psychologist shall not delegate professional responsibilities to a person not qualified and/or not appropriately credentialed to provide such services.

(c) Providing supervision. The psychologist shall exercise appropriate supervision over supervisees.

**WSR 92-15-149**

**PROPOSED RULES**

**DEPARTMENT OF HEALTH**

[Filed July 22, 1992, 11:30 a.m.]

Original Notice.

Title of Rule: Drinking water certification fees, WAC 246-390-990.

Purpose: To establish and maintain a state drinking water program for the certification of laboratories conducting analytical measurement of drinking water contaminants pursuant to the requirements of the state primacy agreement between EPA and the state. Required by 40 CFR 142.10, July 1, 1990, and Public Law 99-339 the Federal Safety Drinking Water Act.

Statutory Authority for Adoption: RCW 43.70.250.

Summary: The proposed fee schedule list all the required fees for drinking water certification.

Reasons Supporting Proposal: Fees are required to partially support the drinking water certification program.

Name of Agency Personnel Responsible for Drafting: Dave Bingham, PHL, 1610 N.E. 150th Street, Seattle, Mailstop K17-9, 245-2822 scan; Implementation: Dr. Jon Counts, PHL, 1610 N.E. 150th Street, Seattle, Mailstop K17-9, SCAN 245-2816; and Enforcement: Jac Davis, PHL, 1610 N.E. 150th Street, Mailstop K17-9, SCAN 245-2910.

Name of Proponent: Department of Health, governmental.

Rule is necessary because of federal law, 40 CFR Part 142.10 and State Statute Chapter.

Explanation of Rule, its Purpose, and Anticipated Effects: This rule implements the Federal Drinking Water Act requirements. Laboratories will be certified for analysis of parameters selected by the laboratory to comply with requirements set forth in the EPA Manual for Certification of Laboratories Analyzing Drinking Water, EPA/570/9-90/008, 4/90. Approximately 50 laboratories in the state will be affected by the certification program.

Proposal does not change existing rules.

This is a new rule.

#### Small Business Economic Impact Statement

The department has considered whether this rule is subject to the Regulatory Fairness Act and has determined that it is not for the following reasons: The rule does not affect more than 10% of one industry or 20% of all industries; the rule being adopted is solely to comply with federal laws and regulation, to satisfy the intent of the primacy agreement between the United States Environmental Protection Agency and the state, in compliance with 40 CFR 142.10, 7/1/90; and the rule will have minor or negligible economic impact on the industry as a whole.

Summary: The proposed regulation will not have an economic impact on more than 20% of all industries or more than 10% of the businesses in any one industry. We estimated there are approximately one thousand commercial analytical laboratories doing business in the state of Washington and only approximately fifty commercial laboratories will be affected by the rule. We also estimated the fee charge for processing the application and submitting the proper fees to help operate the program on a yearly basis would not exceed three-tenth of

one percent of the annual gross income of the five percent of the smallest businesses impacted by the fee charge. The fees charged are based on the number and type of tests for which a laboratory request certification. Smaller businesses which do fewer types of tests would pay a lower fee.

Background: The proposed regulations would establish specific state of Washington rules and regulation for analytical laboratories analyzing drinking water for the state, to comply with United States Environmental Protection Agency requirements in 40 CFR 142.10. Presently, specific standards and limitations are only in the federal regulations. The proposed regulation is similar to the federal requirements with a few additional constraints. Any laboratory wanting to test Washington drinking water must be certified. This includes commercial analytical labs, university labs and local government labs such as local health departments. The basic requirements for certification involve using EPA approved analytical methods and following guidelines established for good laboratory practices, quality assurance, facilities, and qualified personnel to operate the laboratory.

Impact Analysis: As a result of this regulation, laboratory doing testing will have to pay a fee. This fee would not exceed three-tenths of one percent of the annual gross income of the five percent of smallest businesses affected. There may be other cost to a laboratory associated with certification, such as capital improvements necessary to use EPA approved methods or follow good laboratory practices. These other cost[s] come as a result of the federal requirement, and would affect laboratories in this program regardless of the existence of state regulations.

Hearing Location: General Administration Auditorium, 11th and Columbia, Olympia, WA 98504, on September 22, 1992, at 1:00 p.m.

Submit Written Comments to: Ann Foster, Department of Health, Rules Management, 1300 S.E. Quince Street, P.O. Box 47902, Olympia, WA 98504-7902, by September 14, 1992.

Date of Intended Adoption: September 29, 1992.

July 15, 1992

Kristine M. Gebbie  
Secretary

#### NEW SECTION

WAC 246-390-990 FEES. The fees in this section are established in accordance with RCW 43.70.250 to defray the department's costs associated with certifying laboratories. The department shall review the fee structure annually and may modify the fees as necessary to reflect current administrative costs.

(1) On-site inspections shall not be conducted nor shall provisional or other certifications be granted until appropriate fees have been received by the department.

(2) Out-of-state laboratories requesting reciprocity shall pay a fee of one hundred dollars.

(3) Out-of-state laboratories in states which have not established a reciprocity agreement with Washington shall follow the fee schedule in this section and pay all travel costs for the CO for any necessary on-site inspections.

(4) The following fees are due upon application and at the time of each renewal:

BASE FEE OF \$100 PLUS THE FOLLOWING SCHEDULE

Category	Parameter	Symbol	Fee/Parameter	Max. Fee per Category	
Inorganic Contaminants & Physical Characteristics	Arsenic	As	\$60.00	\$1000.00	
	Barium	Ba			
	Cadmium	Cd			
	Chromium	Cr			
	Iron	Fe			
	Lead	Pb			
	Manganese	Mn			
	Mercury	Hg			
	Selenium	Se			
	Silver	Ag			
	Sodium	Na			
	Hardness				
	Conductivity				
	Turbidity				
	Color				
	Fluoride	F			
	Nitrate	as N			
	Chloride	Cl			
	Sulfate	SO <sub>4</sub>			
	TDS				
Copper	Cu				
Zinc	Zn				
Residual Disinfection	Chlorine				
	Ozone				
	Chlorine Dioxide				
	Alkalinity				
	Calcium				
	Nitrite				
	Temperature				
	pH				
	Chloride				
	Organic Contaminants (GC, GC/MS)	Insecticides (Endrin, Lindane, methoxychlor & toxaphene)		\$150.00	\$750.00
		Herbicides (2,4-D & 2,4,5-TP)		\$150.00	
		TTHM		\$150.00	
		MTP		\$150.00	
		Regulated VOCs		\$150.00	
Unregulated VOCs			\$150.00		
Microbiological	MF		\$150.00	\$450.00	
	P-A		\$150.00		
	HPC		\$150.00		
	MPN		\$150.00		
Radiological	Gross alpha		\$150.00	\$1400.00	
	Radium-226		\$150.00		
	Radium-228		\$150.00		
	Uranium		\$150.00		
	Gross beta		\$150.00		
	Strontium-89		\$150.00		
	Strontium-90		\$150.00		
	Photon Emitters		\$150.00		
	Iodine-131		\$150.00		
	Tritium		\$150.00		
Radon		\$150.00			

Title of Rule: WAC 246-926-180, Contrast media administration guidelines.

Purpose: Amend WAC to eliminate the need for certified radiologic technologist to maintain an additional certification as health care assistants.

Statutory Authority for Adoption: RCW 43.70.040.

Statute Being Implemented: RCW 18.84.040.

Summary: Amendment to bring WAC in compliance with current standards of practice and remove outdated language.

Reasons Supporting Proposal: Amendment required in order to meet current standards of practice. Amending the WAC to cover all areas of current standards of practice would eliminate the need for certified technologists to maintain an additional certificate as a health care assistant in order to perform invasive procedures.

Name of Agency Personnel Responsible for Drafting, Implementation and Enforcement: Pam Mena, 1300 S.E. Quince Street, EY-28, Olympia, WA 98604 [98504], 586-6100.

Name of Proponent: Washington State Radiologic Technology Advisory Committee, governmental.

Rule is not necessitated by federal law, federal or state court decision.

Explanation of Rule, its Purpose, and Anticipated Effects: WAC amendment will allow certified radiologic technologists to administer diagnostic and therapeutic agents and perform vena puncture under direction and supervision of radiologists. Current WAC only allow administration of radiopaque diagnostic agents to be administered by a certified diagnostic radiologic technologists and does not allow for vena puncture to be performed. Under the current standards of practice, both certified therapeutic and nuclear medicine technologists administer diagnostic and therapeutic agents. The amendment would also eliminate the need for certified technologists to maintain an additional certification as a health care assistant.

Proposal Changes the Following Existing Rules: Proposal will bring WAC up to date with current standards of practice and will eliminate need to dual certifications.

No small business economic impact statement is required for this proposal by chapter 19.85 RCW.

Hearing Location: General Administration Auditorium, 11th and Columbia, Olympia, WA 98504, on August 26, 1992, at 1:30 p.m.

Submit Written Comments to: Ann Foster, Rules Coordinator, 1300 S.E. Quince Street, P.O. Box 47902, Olympia, WA 98504-7902, by August 24, 1992.

Date of Intended Adoption: September 2, 1992.

July 15, 1992  
Kristine M. Gebbie  
Secretary

**WSR 92-15-150**  
**PROPOSED RULES**  
**DEPARTMENT OF HEALTH**  
**(Radiologic Technology Advisory Committee)**  
[Filed July 22, 1992, 11:32 a.m.]

Original Notice.

AMENDATORY SECTION (Amending Order 121, filed 12/27/90, effective 1/31/91)

WAC 246-926-180 (~~CONTRAST MEDIA ADMINISTRATION GUIDELINES~~) PARENTERAL PROCEDURES. (1) A certified radiologic (~~diagnostic~~) technologist may administer (~~radiopaque~~) diagnostic and therapeutic agents under the direction and immediate supervision of a radiologist if the following guidelines are met: (~~(+)~~) (a) The radiologic technologist has had the prerequisite training and thorough knowledge of the particular procedure to be performed;

~~((2))~~ (b) Appropriate facilities are available for coping with any complication of the procedure as well as for emergency treatment of severe reactions to the ~~((contrast))~~ diagnostic or therapeutic agent itself, including the ready availability of appropriate resuscitative drugs, equipment, and personnel; and

~~((3))~~ (c) After parenteral administration of a ~~((radiopaque))~~ diagnostic or therapeutic agent, competent personnel and emergency facilities shall be available for at least thirty minutes in case of a delayed reaction.

(2) A certified radiologic technologist may perform venipuncture at the direction and immediate supervision of a radiologist.

**WSR 92-15-151**  
**PROPOSED RULES**  
**DEPARTMENT OF HEALTH**

[Filed July 22, 1992, 11:34 a.m.]

**Original Notice.**

Title of Rule: WAC 246-924-115 Brief adjudicative proceedings—Denials based on failure to meet education, experience, or examination prerequisites for licensure.

Purpose: Allow for brief adjudicative proceedings regarding denials rather than full hearings before the entire Examining Board of Psychology.

Statutory Authority for Adoption: RCW 18.83.050.

Statute Being Implemented: Chapter 18.83 RCW.

Summary: Brief adjudicative hearings regarding denial of applications for licensure as a psychologist.

Name of Agency Personnel Responsible for Drafting, Implementation and Enforcement: Terry J. West, 1300 S.E. Quince Street, Mailstop 7868, Olympia, WA 98504-7868, 753-3095.

Name of Proponent: Examining Board of Psychology, governmental.

Rule is not necessitated by federal law, federal or state court decision.

Explanation of Rule, its Purpose, and Anticipated Effects: Rule to allow brief adjudicative hearings based on denial of application for licensure as a psychologist. Brief adjudicative hearing is quick and easy to schedule rather than the lengthy process in existence now.

Proposal does not change existing rules.

No small business economic impact statement is required for this proposal by chapter 19.85 RCW.

Hearing Location: Sea-Tac Airport Hilton, 17620 Pacific Highway South, SeaTac, WA 98188, Peninsula West Room, on September 11, 1992, at 1:30 p.m.

Submit Written Comments to: Terry J. West, Program Manager, 1300 S.E. Quince Street, Mailstop 7868, Olympia, WA 98504-7868, by September 7, 1992.

Date of Intended Adoption: September 11, 1992.

July 16, 1992

Dave Gossett, Chair

Examining Board of Psychology

**NEW SECTION**

WAC 246-924-115 BRIEF ADJUDICATIVE PROCEEDINGS—DENIALS BASED ON FAILURE TO MEET EDUCATION, EXPERIENCE, OR EXAMINATION PREREQUISITES FOR LICENSURE. The board adopts RCW 34.05.482 and 34.05.485 through 34.05.494 for adjudicative proceedings requested by applicants, who are denied a license under chapter 18.83 RCW for failure

to meet the education, experience, or examination prerequisites for licensure. The sole issue at the adjudicative proceeding shall be whether the applicant meets the education, experience, and examination prerequisites for the issuance of a license.

**WSR 92-15-152**  
**PERMANENT RULES**  
**DEPARTMENT OF HEALTH**  
**(Board of Health)**

[Order 290B—Filed July 22, 1992, 11:38 a.m.]

Date of Adoption: May 13, 1992.

Purpose: To establish and maintain a state drinking water program for the certification of laboratories conducting analytical measurement of drinking water contaminants pursuant to the requirements of the state primacy agreement between EPA and the state. Required by 40 CFR 142.10, 7/1/90 and PL 99-339 The Federal Safe Drinking Water Act.

Statutory Authority for Adoption: RCW 43.20.050.

Pursuant to notice filed as WSR 92-07-078 on March 17, 1992.

Changes Other than Editing from Proposed to Adopted Version: WAC 246-390-001 under Purpose—Objectives added (2)(d) Fosters cooperation between the state department of health, local health agencies, and operations of laboratories.

Effective Date of Rule: Thirty-one days after filing.

July 14, 1992

Sylvia I. Beck

Executive Director

**Chapter 246-390 WAC**  
**DRINKING WATER CERTIFICATION RULES**

**NEW SECTION**

**WAC 246-390-001 PURPOSE—OBJECTIVES.**

(1) The purpose of this chapter is to establish a state drinking water program for certification of laboratories analyzing public drinking water under RCW 43.20.050. The certification program is designed to satisfy the intent of the primacy agreement with United States Environmental Protection Agency and the state, in compliance with 40 C.F.R. 142.10, 7/1/90.

(2) The department certification program:

(a) Requires laboratories to demonstrate capability to accurately analyze drinking water samples;

(b) Aids laboratories in improving quality assurance;

(c) Offers technical assistance in all drinking water analyses; and

(d) Fosters cooperation between the state department of health, local health agencies, and operators of laboratories.

**NEW SECTION**

WAC 246-390-010 DEFINITIONS. Definitions in this section shall apply throughout this chapter, unless clearly indicated otherwise.



(1) "Administrative Procedure Act" means the adjudicative proceedings governed by chapter 34.05 RCW and chapter 246-08 WAC.

(2) "Analytical data" means the recorded qualitative and/or quantitative results of a chemical, physical, biological, microbiological, or radiological determination.

(3) "Certification" means the formal contractual agreement between the department and the certified laboratory indicating a laboratory is capable of producing accurate analytical data and is authorized to test drinking water compliance samples. The department will issue a certificate to the laboratory indicating the contaminants the laboratory is authorized to analyze. Certification does not guarantee validity of analytical data submitted by a certified laboratory.

(4) "Certification authority" means the designated official or a representative of the official authorized by the department as the head of the certification program.

(5) "Certification manual" means the most recent revision of the procedural and technical criteria of the drinking water certification rules. This document, entitled "Certification Manual for Laboratories Analyzing Washington State Drinking Water," is available from the Department of Health, Public Health Laboratory, Drinking Water Certification Program, 1610 NE 150th St., Seattle, Washington 98155-7224.

(6) "Certification official (CO)" means the designated official authorized by the department to certify drinking water laboratories.

(7) "Compliance sample" means a drinking water sample collected in accordance with WAC 246-290-300 and/or 246-290-320 and submitted to a state certified laboratory for analysis.

(8) "Department" means the Washington state department of health.

(9) "EMSL-CI" means the EPA Environmental Monitoring and Support Laboratory, Cincinnati, Ohio.

(10) "EMSL-LV" means the EPA Environmental Monitoring System Laboratory, Las Vegas, Nevada.

(11) "EPA" means United States Environmental Protection Agency.

(12) "Intercomparison studies" means a series of cross check samples sent to radiochemistry laboratories by EPA to compare the results between participating laboratories.

(13) "Laboratory" means any facility under the ownership and technical management of a single entity in a single geographical locale. A laboratory is where scientific examinations are performed on drinking water samples.

(14) "Maximum contaminant level (MCL)" means the maximum permissible level of a contaminant in water the purveyor delivers to any public water system user, measured at the location identified under WAC 246-290-300, Table 4.

(15) "Official methods" means methodologies specified by EPA drinking water regulations under 40 C.F.R. 141.21 - 141.30, 141.41 - 141.42, 7/1/90 and approved by the department.

(16) "Parameter" means a single determination or group of related determinations using a specific written official method.

(17) "Performance evaluation (PE)" means an evaluation of the results of analysis of samples from an external testing source whose true values are unknown to the laboratory conducting the analysis. The external testing service must be approved by the department and/or CO if other than EPA sources are used.

(18) "On-site audit" means an on-site inspection performed by the department to determine a laboratory's capabilities and facilities.

(19) "Quality assurance (QA)" means all those planned and systematic actions necessary to provide confidence that an analysis, measurement, or surveillance program produces data of known and defensible quality.

(20) "Quality controls (QC)" means internal written procedures and routine analyses of laboratory reference materials, samples, and blanks to insure precision and accuracy of methodology, equipment and results.

(21) "State advisory level (SAL)" means a department-established value for a chemical without an existing MCL. The SAL represents a level which when exceeded, indicates the need for further assessment to determine if the chemical is an actual or potential threat to human health.

#### NEW SECTION

WAC 246-390-020 REQUIREMENT FOR CERTIFICATION. (1) Certification officers are required to meet EPA requirements for drinking water certification as described in the latest version of the Manual for the Certification of Laboratories Analyzing Drinking Water, EPA/570/9-90/008,4/90.

(2) Applicants for laboratory certification shall submit to the department:

(a) An application fee as specified in WAC 246-390-990;

(b) A written application which includes one of the following:

(i) A request for first-time certification;

(ii) A request for certification to analyze additional or newly regulated contaminants; or

(iii) A request to reapply for certification after correction of deficiencies which resulted in the downgrading or revocation of certification status, or after lapse of previous contract; and

(c) A QA plan as specified in subsection (6) of this section.

(3) Applicants for routine renewal shall submit to the department at least three months before expiration of the contract:

(a) A renewal fee as specified in WAC 246-390-990;

(b) A written application which includes:

(i) Name and address of each laboratory or testing site;

(ii) Owner's name, address, and contact person;

(iii) List of parameters to be certified;

(iv) Completed personnel training and experience forms;

(v) List of methods used;

(vi) Copy of QA manual; and

(vii) List of equipment;



(c) Verification of the successful performance of PE studies as specified in subsection (4) of this section; and

(d) A QA plan, if changes have been made since the plan was last submitted to the department.

(4) Laboratory approved personnel shall participate in EPA Water Supply, EMSL-CI, EMSL-LV, or other department approved PE studies at least once annually for microbiological and twice annually for chemistry and radiochemistry laboratories as described in the certification manual. Radiochemistry laboratories must also participate in two intercomparison studies per year.

(5) Laboratory directors shall allow on-site audit by the CO as follows:

- (a) At least every three years;
- (b) Announced or unannounced;
- (c) At contract renewal; or
- (d) At the discretion of the CO.

(6) Laboratory directors shall submit a QA plan with a section specific to drinking water with initial application; at contract renewal, if changes have been made; or at the discretion of the CO. The QA plan or manual shall follow EPA and state requirements, as described in the certification manual.

(7) Laboratory personnel shall notify the CO in writing within thirty days of major changes to analytical staff management including:

- (a) Moving facilities;
- (b) Loss or replacement of the laboratory supervisor;
- (c) A situation in which a trained and experienced analyst no longer is available to analyze a particular parameter for which certification had been granted;
- (d) Loss or replacement of major equipment; and
- (e) Any other situation described in the certification manual that would affect laboratory operations.

(8) Laboratories shall meet the following minimum workload requirements for each certified parameter:

(a) Microbiological laboratories to analyze a minimum of fifteen water samples per quarter that are positive for both total and fecal coliform.

(b) Chemistry and radiochemistry laboratories to analyze five water samples per quarter. These workload requirements shall not include PE samples. Laboratories must assure the CO that proper QA/QC was followed, and official drinking water methods were used. See certification manual for further explanation.

(9) Laboratory personnel shall follow official EPA methods, or EPA approved alternate analytical techniques, as described in the certification manual.

(10) Laboratory personnel shall accurately report analytical results of compliance samples in a timely manner as described in the certification manual using:

- (a) The department specified format; and
- (b) Electronic or hard copy transmission.

(11) Laboratories shall follow the standard of quality requirements as described in the certification manual.

#### NEW SECTION

WAC 246-390-030 CERTIFICATION. (1) The department may grant certification to a laboratory after conducting a complete assessment of the laboratory's capabilities, including:

- (a) Submission of a completed application;

(b) Submission of the proper fees;

(c) Satisfactory performance on PE studies, and intercomparison samples where necessary;

(d) Submission of an updated QA plan; and

(e) Successful completion of an on-site inspection.

(2) The department may grant less than full certification based on terms and conditions incorporated in the contractual agreement between the laboratory and the department.

#### NEW SECTION

WAC 246-390-040 PROVISIONAL CERTIFICATION. Laboratories which have deficiencies requiring corrective action but which can produce valid analytical data as determined by the CO may be given provisional certification. The department may downgrade a laboratory to provisional certification for failure to:

(1) Analyze a PE sample and/or an intercomparison sample, or any other unknown test sample within the acceptance limits established by the EPA and/or the department. Failure on a mandatory PE sample is defined as a failure on any concentration provided, unless otherwise specified by the EPA and/or the department. The laboratory shall be given an opportunity to request a make up PE or QC sample before the CO takes action.

(2) Notify the CO in writing within thirty days of major change impairing analytical capability, such as personnel, equipment, or location.

(3) Demonstrate that the laboratory maintains the required standard of quality, based upon an on-site evaluation. See certification manual for minimum standard of quality requirements.

(4) Promptly send reports of analysis to the department as described in the certification manual.

(5) Promptly notify the public water system by the end of the business day, or the department if the public water system can not be notified, of results exceeding MCL or SAL. For all results exceeding MCL or SAL the laboratory must notify the department as soon as possible.

#### NEW SECTION

WAC 246-390-050 REVOKING OR DENYING CERTIFICATION. Action shall be taken consistent with the contract, with 40 C.F.R. 142.10 7/1/90, EPA Manual, RCW 43.20.050, and chapter 246-08 WAC. The department may immediately downgrade laboratories from certified or provisionally certified to not certified, or may deny certification for a particular contaminant analysis or group of contaminants, for the following reasons:

(1) Two consecutive failures to analyze a PE sample or intercomparison sample or any other unknown test sample for a particular contaminant within the acceptance limits established by EPA and/or the department. The laboratory shall be given an opportunity to request a make-up PE or QC sample before the CO takes final action. The decision to revoke certification shall be made at the discretion of the CO after examination of all information.

(2) Failure to demonstrate to the CO that the laboratory has corrected deficiencies identified during an on-site evaluation within:

(a) Three months to correct a procedural or administrative deficiency; and

(b) Six months to correct an equipment deficiency. If the equipment or instrument involved is the only instrument available for a particular analysis, certification may be downgraded immediately, at the discretion of the CO.

(3) Submission of a PE sample to another laboratory for analysis and reporting data as its own.

(4) Failure to use analytical methodology specified in the certification manual.

(5) Failure to submit an appropriate application and associated fees to the department.

(6) Failure to pass a re-audit and correct deficiencies if the laboratory is found deficient in its ability to provide accurate analytical data.

(7) Justifiable evidence of falsification of data or any other practice considered deceptive by the department.

(8) Failure to comply with other provisions of the contractual agreement between the department and the laboratory.

(9) Failure to correct deficiencies quoted in a revoked certificate before reapplying for certification.

(10) Failure to permit entry of a CO or CO's representative for an on-site audit to examine methods, facilities, equipment, and analytical data.

#### NEW SECTION

WAC 246-390-060 **RECIPROCITY**. The department may recognize certification of an out-of-state laboratory by another primacy state with which the department has an established mutual reciprocity agreement. The laboratory shall submit an application and a fee as specified in WAC 246-390-990; perform approved PE studies; follow the workload requirements; and follow drinking water methods per WAC 246-390-020. A laboratory accepted under the reciprocity agreement shall enter into a contract with the department.

#### NEW SECTION

WAC 246-390-070 **THIRD-PARTY CERTIFICATION**. The department shall recognize only the certification officials authorized and approved by the department. See certification manual for recognized and approved certification officials. Laboratories requesting third party certification shall submit an application; perform approved PE studies; follow the workload requirements; and follow drinking water methods per WAC 246-390-020.

#### NEW SECTION

WAC 246-390-100 **APPEALS**. A laboratory manager may appeal any certification action such as denial and revocation in writing to the CO. If the question is not satisfactorily resolved, the laboratory manager may appeal in writing by certified mail to the certification authority within thirty days of the decision of the CO. Decisions of the certification authority may be appealed

to the secretary of the department within thirty days of notification of final action. The adjudication procedure is governed by the Administrative Procedure Act, this chapter, and chapter 246-08 WAC. Laboratories may be allowed to maintain certification during the appeal process.

#### **WSR 92-15-153**

##### **PERMANENT RULES**

##### **DEPARTMENT OF HEALTH**

[Order 291B—Filed July 22, 1992, 11:40 a.m.]

Date of Adoption: March 2, 1992.

Purpose: These rules add specific language regarding national educational institutions approval process by the Board of Massage. The anticipated effects include a variety of disciplines having the ability to retain professional integrity while being licensed as massage practitioners.

Citation of Existing Rules Affected by this Order: Amending WAC 246-830-401, 246-830-410, 246-830-420, 246-830-430, 246-830-440, and 246-830-450.

Statutory Authority for Adoption: RCW 18.108.025.

Pursuant to notice filed as WSR 92-03-139 on January 22, 1992.

Effective Date of Rule: Thirty-one days after filing.

March 2, 1992

Katherine Huff

Chair of Massage Board

**AMENDATORY SECTION** (Amending Order 102B, filed 12/17/90, effective 1/31/91)

WAC 246-830-401 **SCOPE AND PURPOSE**. (1) The minimum educational requirements for licensure to practice massage therapy and/or bodywork/somatic education in Washington is successful completion of a course of study from a massage school ((or)), program, or national educational institution approved by the board.

(2) The purpose of this chapter is to provide a set of standards and procedures by which massage schools ((or)), programs, or national educational institutions may obtain approval by the board in order that graduates of those schools ((or)), programs, or national educational institutions may be permitted to take examinations for licensure.

**AMENDATORY SECTION** (Amending Order 102B, filed 12/17/90, effective 1/31/91)

WAC 246-830-410 **DEFINITIONS**. For the purpose of administering chapter 18.108 RCW, the following terms shall be considered in the following manner:

(1) A massage school is an institution which has the sole purpose of offering training in massage therapy.

(2) A massage program is training in massage therapy offered by an academic institution which also offers training in other areas of study. A program is an established area of study offered on a continuing basis.

(3) An apprentice is defined, for purposes of this chapter, as one who has successfully completed:

(a) One hundred thirty hours of instruction in anatomy, physiology, and kinesiology including palpation, range of motion and physics of joint function. There must be a minimum of forty hours of kinesiology.

(b) Fifty hours of instruction in pathology, including indications and contraindications to massage therapy and palpations.

(c) Certification in American Red Cross first aid and American Heart Association CPR or the equivalent.

The above courses must be successfully completed within five years immediately preceding entry into an apprenticeship agreement. The apprentice then shall receive complete training in:

(i) Hydrotherapy (fifteen hours);

(ii) Theory and practice of massage therapy (two hundred fifty hours) at a minimum to include Swedish and deep tissue techniques, remedial gymnastics, body mechanics of the practitioner, and medical treatments. A maximum of fifty of these hours may include time spent in a student clinic; and

(iii) Clinical practices (fifty-five hours), at a minimum to include hygiene, recordkeeping, medical terminology, professional ethics, business management, human behavior, client interaction, and state and local laws. Training in hydrotherapy, theory and practice of massage therapy, and clinical practices shall be completed in no less than six months or longer than two years from the date of entry into an apprenticeship program.

(4) A massage apprenticeship is training in massage therapy which is offered by a qualified massage practitioner to an apprentice on the basis of an apprenticeship agreement between the massage practitioner and the apprentice. Such agreement shall comply with the educational standards as set forth in this chapter. A qualified massage practitioner is defined as a person that shall have not less than three years full-time experience in the practice of massage immediately preceding the function as an apprenticeship trainer of massage therapy in an apprenticeship agreement and shall be licensed under this chapter and currently engaged in the practice of massage.

Hereinafter, qualified massage practitioner is referred to as apprenticeship trainer (~~and apprenticeship program is referred to as program~~).

(5) A national educational institution is an institution which has the purpose of directly supervising training programs in bodywork/somatic education. A national educational institution may also be a program which is established for the purpose of offering training in bodywork/somatic education offered in an academic institution which also offers training in other areas of study.

(6) A program is an established area of study offered on a continuous or periodic basis. The national educational institution's certification program must have a permanent administrative location and must have training location requirements. The institution's certification program may have its own registered trademark<sup>TM</sup>/servicemark<sup>SM</sup>. The certification program must have a code of ethics.

(7) Bodywork/somatic education shall be defined as any established method other than swedish massage in which the practitioner uses touch to improve the function, organization, structure, and well-being of a person.

AMENDATORY SECTION (Amending Order 102B, filed 12/17/90, effective 1/31/91)

WAC 246-830-420 APPROVAL OF SCHOOL, PROGRAM, OR APPRENTICESHIP PROGRAM. The board may accept proof of (~~(AMTA, (American Massage Therapy Association);)~~) a national professional association's approval of a school or program based on standards and requirements which are substantially equivalent to those identified in this chapter, in lieu of the requirements contained in this chapter. Approval in this manner may be requested on a form provided by the department. The board will consider for approval any school, program, or apprenticeship program which meets the requirements as outlined in this chapter.

(1) Approval of any other school or program may be requested on a form provided by the department.

(2) Application for approval of a school or program, shall be made by the authorized representative of the school or the administrator of the apprenticeship agreement.

(3) The authorized representative of the school or the administrator of the apprenticeship program may request approval of the school or program, as of the date of the application or retroactively to a specified date.

(4) The application for approval of a school (~~(or)~~), program, or national educational institution shall include, but not be limited to, documentation required by the board pertaining to: Syllabus, qualifications of instructors, training locations, and facilities, outline of curriculum plan specifying all subjects and length in hours such subjects are taught, class objectives, and a sample copy of one of each of the following exams: Anatomy, physiology, and massage therapy or bodywork/somatic education.

(5) Any school, national educational institution, or program that is required to be licensed by private vocational education (see chapter 28C.10 RCW or Title 28B RCW); or any other statute, must complete these requirements before being considered by the board for approval.

(6) The board will evaluate the application and, if necessary, conduct a site inspection of the school, national educational institution, or program, prior to granting approval by the board.

(7) Upon completion of the evaluation of the application, the board may grant or deny approval or grant approval conditioned upon appropriate modification to the application.

(8) In the event the department denies an application or grants conditional approval, the authorized representative of the applicant's school or program may request a review within thirty days of the board's adverse decision/action. Should a request for review of an adverse action be made after thirty days following the board's action, the contesting party may obtain review only by submitting a new application.

(9) The authorized representative of an approved school, national educational institution, or program or the administrator of an apprenticeship agreement shall notify the board of significant changes with respect to information provided on the application within sixty days.

(10) The board may inspect or review an approved school, national educational institution, or program at reasonable intervals for compliance. Approval may be withdrawn if the board finds failure to comply with the requirements of law, administrative rules, or representations in the application.

(11) The authorized representative of a school, national educational institution, or administrator of an agreement must immediately correct the deficiencies which resulted in withdrawal of the board's approval.

**AMENDATORY SECTION** (Amending Order 102B, filed 12/17/90, effective 1/31/91)

WAC 246-830-430 TRAINING. (1) The training in massage therapy shall consist of a minimum of five hundred hours. An hour of training is defined as fifty minutes of actual instructional time. Certification in American Red Cross first aid and American Heart Association CPR or the equivalent shall be required. This requirement is in addition to the five hundred hours of training in massage therapy. These five hundred hours are not to be completed in less than six months and shall consist of the following:

~~((1))~~ (a) One hundred thirty hours of anatomy, physiology, and kinesiology including palpation, range of motion, and physics of joint function. There must be a minimum of forty hours of kinesiology.

~~((2))~~ (b) Fifty hours of pathology including indications and contraindications to massage therapy and palpations.

~~((3))~~ (c) Two hundred fifty hours of theory and practice of massage therapy, at a minimum to include Swedish and deep tissue techniques, remedial gymnastics, body mechanics of the practitioner, and medical treatments. A maximum of fifty of these hours may include time spent in a student clinic.

~~((4))~~ (d) Fifteen hours of hydrotherapy.

~~((5))~~ (e) Fifty-five hours of clinical/business practices, at a minimum to include hygiene, recordkeeping, medical terminology, professional ethics, business management, human behavior, client interaction, and state and local laws.

(2) The training in a national educational institution program shall consist of a minimum of five hundred hours. An hour of training is defined as fifty minutes of actual instructional time. Certification in American Red Cross first aid and American Heart Association CPR or the equivalent shall be required. This requirement is in addition to the five hundred hours of training required of the national educational institution. These five hundred hours are not to be completed in less than six months and shall consist of the following:

(a) One hundred thirty hours of anatomy, physiology, and kinesiology including palpation, range of motion, and physics of joint function. There must be a minimum of forty hours of kinesiology.

(b) Fifty hours of pathology including indications and contraindications.

(c) Two hundred sixty-five hours of theory and practice of bodywork/somatic education, a minimum to include analysis and evaluation of the physical and/or energetic structure, tissue handling techniques, body mechanics of the practitioner, and medical implications. A maximum of fifty of these hours may include time spent in a student clinic.

(d) Fifty-five hours of clinical/business practices, at a minimum to include hygiene, recordkeeping, medical terminology, professional ethics, business management, human behavior, client interaction, and state and local laws.

(e) A bodywork/somatic education program shall have a curriculum and system of training consistent with its particular area of practice.

**AMENDATORY SECTION** (Amending Order 102B, filed 12/17/90, effective 1/31/91)

WAC 246-830-440 CURRICULUM—ACADEMIC STANDARDS—FACULTY—STUDENT CLINIC. (1) The curriculum of the school, national educational institution's program, or apprenticeship program shall be designed and presented to meet or exceed the requirement of five hundred hours.

(2) Academic standards. The school, national educational institution, or apprenticeship trainer shall regularly evaluate the quality of its instruction and have a clearly defined set of standards of competence required of its students. Promotion to each successive phase of the program and graduation shall be dependent on mastery of the knowledge and skills presented in the program.

(3) Faculty. Apprenticeship trainers and faculty members shall be qualified by training and experience to give effective instruction in the subject(s) taught. The apprenticeship trainer and faculty should develop and evaluate the curriculum instructional methods and facilities; student discipline, welfare, and counseling; assist in the establishment of administrative and educational policies, and scholarly and professional growth. Schools, national educational institutions or programs, or apprenticeship programs shall not discriminate on the basis of sex, race, age, color, religion, physical handicap, or national or ethnic origin in the recruitment and hiring of faculty.

(4) Student clinic (optional program). The clinical facilities shall be adequate in size, number, and resources to provide for student practice of massage ~~((therapy))~~ or bodywork/somatic education on the general public. There shall be properly equipped rooms for consultations, massage therapy or treatment, and equipment as required in the practice of massage or bodywork/somatic education. A faculty member who is a licensed massage practitioner and adequately experienced in massage therapy or an instructor who is certified by the national educational institution as an instructor of bodywork/somatic education must be present in the clinic at all times the clinic is open and in direct supervision of, and have final decision in, the massage therapy or bodywork/somatic treatment which is rendered to clients by students.

**AMENDATORY SECTION** (Amending Order 102B, filed 12/17/90, effective 1/31/91)

WAC 246-830-450 HEALTH, SANITATION, AND FACILITY STANDARDS. All programs will have adequate facilities and equipment available for students learning massage therapy or bodywork/somatic education. All facility equipment will be maintained in accordance with local rules and ordinances in addition to those imposed by chapter ((308-51)) 246-830 WAC. Instructional and practice equipment shall be similar to that found in common occupational practice. An adequate reference library, appropriate to the subjects being taught, shall be available.

**WSR 92-15-155**  
**NOTICE OF PUBLIC MEETINGS**  
**BUILDING CODE COUNCIL**  
[Memorandum—July 10, 1992]

The August 14, 1992, regularly scheduled meeting of the Washington State Building Code Council has been canceled. The meetings scheduled for August 13, 1992, for the Energy Code Committee, Barrier-Free Committee, and the Uniform Codes Committee have also been canceled.

**WSR 92-15-154**  
**EMERGENCY RULES**  
**DEPARTMENT OF HEALTH**  
[Order 292B—Filed July 22, 1992, 11:43 a.m.]

Date of Adoption: July 20, 1992.

Purpose: Adopt rule that will allow brief adjudicative proceedings for denials of applications based on their failure to meet education, experience, or examination prerequisites for licensure. WAC 246-924-115 Brief adjudicative proceedings.

Statutory Authority for Adoption: RCW 18.83.050.

Pursuant to RCW 34.05.350 the agency for good cause finds that immediate adoption, amendment, or repeal of a rule is necessary for the preservation of the public health, safety, or general welfare, and that observing the time requirements of notice and opportunity to comment upon adoption of a permanent rule would be contrary to the public interest.

Reasons for this Finding: This rule will allow for brief adjudicative proceedings which can be conducted in a short amount of time versus having to wait for a full hearing before the entire Examining Board of Psychology.

Effective Date of Rule: Immediately.

July 20, 1992  
Dave Gossett, Chair  
Examining Board of Psychology

**NEW SECTION**

WAC 246-924-115 **BRIEF ADJUDICATIVE PROCEEDINGS—DENIALS BASED ON FAILURE TO MEET EDUCATION, EXPERIENCE, OR EXAMINATION PREREQUISITES FOR LICENSURE.** The board adopts RCW 34.05.482 and 34.05.485 through 34.05.494 for adjudicative proceedings requested by applicants, who are denied a license under chapter 18.83 RCW for failure to meet the education, experience, or examination prerequisites for licensure. The sole issue at the adjudicative proceeding shall be whether the applicant meets the education, experience, and examination prerequisites for the issuance of a license.

## Table of WAC Sections Affected

### KEY TO TABLE

**Symbols:**

- AMD = Amendment of existing section
- A/R = Amending and recodifying a section
- DECOD = Decodification of an existing section
- NEW = New section not previously codified
- OBJEC = Notice of objection by Joint Administrative Rules Review Committee
- PREP = Preproposal comments
- RE-AD = Readoption of existing section
- RECOD = Recodification of previously codified section
- REP = Repeal of existing section
- RESCIND = Rescind previous emergency rule
- REVIEW = Review of previously adopted rule

**Suffixes:**

- P = Proposed action
- C = Continuance of previous proposal
- E = Emergency action
- S = Supplemental notice
- W = Withdrawal of proposed action
- No suffix means permanent action

This table covers the current calendar year through this issue of the Register and should be used to locate rules amended, adopted, or repealed subsequent to the publication date of the latest WAC or Supplement.

WAC # shows the section number under which an agency rule is or will be codified in the Washington Administrative Code.

WSR # shows the issue of the Washington State Register where the document may be found; the last three digits show the sequence of the document within the issue.

WAC #	WSR #	WAC #	WSR #	WAC #	WSR #
4-25-190	REP-W	92-03-062	16-164-010	NEW-P	92-13-100
16-10-010	NEW-P	92-06-084	16-164-020	NEW-P	92-13-100
16-10-010	NEW-W	92-10-009	16-164-030	NEW-P	92-13-100
16-10-020	NEW-P	92-06-084	16-164-040	NEW-P	92-13-100
16-10-020	NEW-W	92-10-009	16-164-050	NEW-P	92-13-100
16-10-030	NEW-P	92-06-084	16-164-060	NEW-P	92-13-100
16-10-030	NEW-W	92-10-009	16-164-070	NEW-P	92-13-100
16-103-001	NEW-E	92-14-076	16-164-080	NEW-P	92-13-100
16-103-002	NEW-E	92-14-076	16-164-090	NEW-P	92-13-100
16-103-003	NEW-E	92-14-076	16-164-100	NEW-P	92-13-100
16-141-010	NEW-E	92-07-070	16-166-010	NEW-P	92-13-099
16-146-100	AMD-P	92-15-060	16-166-020	NEW-P	92-13-099
16-146-100	AMD-E	92-16-061	16-166-030	NEW-P	92-13-099
16-146-110	AMD-P	92-15-060	16-166-040	NEW-P	92-13-099
16-146-110	AMD-E	92-16-061	16-166-050	NEW-P	92-13-099
16-156-001	AMD-P	92-07-052	16-166-060	NEW-P	92-13-099
16-156-001	AMD	92-11-001	16-166-070	NEW-P	92-13-099
16-156-003	NEW-P	92-07-052	16-166-080	NEW-P	92-13-099
16-156-003	NEW	92-11-001	16-166-090	NEW-P	92-13-099
16-156-005	AMD-P	92-07-052	16-212-020	AMD-P	92-11-073
16-156-005	AMD	92-11-001	16-212-020	AMD	92-15-046
16-156-010	AMD-P	92-07-052	16-212-060	AMD-P	92-11-073
16-156-010	AMD	92-11-001	16-212-060	AMD	92-15-046
16-156-020	AMD-P	92-07-052	16-212-070	AMD-P	92-11-073
16-156-020	AMD	92-11-001	16-212-070	AMD	92-15-046
16-156-030	AMD-P	92-07-052	16-212-080	AMD-P	92-11-073
16-156-030	AMD	92-11-001	16-212-080	AMD	92-15-046
16-156-035	AMD-P	92-07-052	16-212-082	AMD-P	92-11-073
16-156-035	AMD	92-11-001	16-212-082	AMD	92-15-046
16-156-050	AMD-P	92-07-052	16-228-010	AMD-P	92-03-133
16-156-050	AMD	92-11-001	16-228-010	AMD	92-07-084
16-162-010	NEW-P	92-07-052	16-228-180	AMD-P	92-03-133
16-162-010	NEW	92-11-001	16-228-180	AMD	92-07-084
16-162-025	NEW-P	92-07-052	16-228-214	NEW-P	92-11-077
16-162-025	NEW	92-11-001	16-228-214	NEW	92-15-001
16-162-030	NEW-P	92-07-052	16-228-400	NEW-P	92-03-133
16-162-030	NEW	92-11-001	16-228-400	NEW	92-07-084
16-162-031	NEW-P	92-07-052	16-228-410	NEW-P	92-03-133
16-162-031	NEW	92-11-001	16-228-410	NEW	92-07-084
16-162-032	NEW-P	92-07-052	16-228-420	NEW-P	92-03-133
16-162-032	NEW	92-11-001	16-228-420	NEW	92-07-084
16-162-033	NEW-P	92-07-052	16-228-430	NEW-P	92-03-133
16-162-033	NEW	92-11-001	16-228-430	NEW	92-07-084
16-162-050	NEW-P	92-07-052	16-228-500	NEW-P	92-15-026
16-162-050	NEW	92-11-001	16-228-900	REP-P	92-06-083
16-162-060	NEW-P	92-07-052	16-228-900	REP-W	92-10-008
16-162-070	NEW-P	92-07-052	16-228-905	NEW-P	92-06-083
16-162-070	NEW	92-11-001	16-228-905	NEW-W	92-10-008
16-162-100	NEW-P	92-07-052	16-228-910	NEW-P	92-06-083
16-162-100	NEW	92-11-001	16-228-910	NEW-W	92-10-008

Table of WAC Sections Affected

WAC #	WSR #	WAC #	WSR #	WAC #	WSR #			
16-230-850	AMD-E	92-07-060	16-231-005	REP	92-13-035	16-316-340	AMD-P	92-09-150
16-230-850	RESCIND	92-08-026	16-231-010	REP-P	92-03-134	16-316-340	AMD	92-13-027
16-230-850	AMD-E	92-08-027	16-231-010	REP-S	92-07-059	16-316-350	AMD-P	92-09-150
16-230-850	AMD	92-13-035	16-231-010	REP-E	92-07-060	16-316-350	AMD	92-13-027
16-230-855	AMD-P	92-03-134	16-231-010	RESCIND	92-08-026	16-316-355	AMD-P	92-09-150
16-230-855	AMD-S	92-07-059	16-231-010	REP-E	92-08-027	16-316-355	AMD	92-13-027
16-230-855	AMD-E	92-07-060	16-231-010	REP	92-13-035	16-316-360	AMD-P	92-09-150
16-230-855	RESCIND	92-08-026	16-231-015	REP-P	92-03-134	16-316-360	AMD	92-13-027
16-230-855	AMD-E	92-08-027	16-231-015	REP-S	92-07-059	16-316-370	AMD-P	92-09-150
16-230-855	AMD	92-13-035	16-231-015	REP-E	92-07-060	16-316-370	AMD	92-13-027
16-230-860	AMD-P	92-03-134	16-231-015	RESCIND	92-08-026	16-316-470	AMD-P	92-09-150
16-230-860	AMD-S	92-07-059	16-231-015	REP-E	92-08-027	16-316-470	AMD	92-13-027
16-230-860	AMD-E	92-07-060	16-231-015	REP	92-13-035	16-316-474	AMD-P	92-09-150
16-230-860	RESCIND	92-08-026	16-231-020	REP-P	92-03-134	16-316-474	AMD	92-13-027
16-230-860	AMD-E	92-08-027	16-231-020	REP-S	92-07-059	16-316-525	AMD-P	92-09-150
16-230-860	AMD	92-13-035	16-231-020	REP-E	92-07-060	16-316-525	AMD	92-13-027
16-230-861	AMD-P	92-03-134	16-231-020	RESCIND	92-08-026	16-316-622	AMD-P	92-09-150
16-230-861	AMD-S	92-07-059	16-231-020	REP-E	92-08-027	16-316-622	AMD	92-13-027
16-230-861	AMD-E	92-07-060	16-231-020	REP	92-13-035	16-316-715	AMD-P	92-09-150
16-230-861	RESCIND	92-08-026	16-231-025	REP-P	92-03-134	16-316-715	AMD	92-13-027
16-230-861	AMD-E	92-08-027	16-231-025	REP-S	92-07-059	16-316-717	AMD-P	92-09-150
16-230-861	AMD	92-13-035	16-231-025	REP-E	92-07-060	16-316-717	AMD	92-13-027
16-230-862	NEW-P	92-03-134	16-231-025	RESCIND	92-08-026	16-316-719	AMD-P	92-09-150
16-230-862	NEW-S	92-07-059	16-231-025	REP-E	92-08-027	16-316-719	AMD	92-13-027
16-230-862	NEW-E	92-07-060	16-231-025	REP	92-13-035	16-316-727	AMD-P	92-09-150
16-230-862	RESCIND	92-08-026	16-231-030	REP-P	92-03-134	16-316-727	AMD	92-13-027
16-230-862	NEW-E	92-08-027	16-231-030	REP-S	92-07-059	16-316-800	AMD-P	92-09-150
16-230-862	NEW	92-13-035	16-231-030	REP-E	92-07-060	16-316-800	AMD	92-13-027
16-230-863	NEW-P	92-03-134	16-231-030	RESCIND	92-08-026	16-316-810	AMD-P	92-09-150
16-230-863	NEW-S	92-07-059	16-231-030	REP-E	92-08-027	16-316-810	AMD	92-13-027
16-230-863	NEW-E	92-07-060	16-231-030	REP	92-13-035	16-316-815	AMD-P	92-09-150
16-230-863	RESCIND	92-08-026	16-231-110	AMD-E	92-08-028	16-316-815	AMD	92-13-027
16-230-863	NEW-E	92-08-027	16-231-115	AMD-E	92-08-028	16-316-820	AMD-P	92-09-150
16-230-863	NEW	92-13-035	16-231-119	AMD-E	92-08-028	16-316-820	AMD	92-13-027
16-230-864	NEW-P	92-03-134	16-231-125	AMD-E	92-08-028	16-316-830	AMD-P	92-09-150
16-230-864	NEW-S	92-07-059	16-231-210	AMD-E	92-08-028	16-316-830	AMD	92-13-027
16-230-864	NEW-E	92-07-060	16-231-215	AMD-E	92-08-028	16-316-832	AMD-P	92-09-150
16-230-864	RESCIND	92-08-026	16-231-220	AMD-E	92-08-028	16-316-832	AMD	92-13-027
16-230-864	NEW-E	92-08-027	16-231-225	AMD-E	92-08-028	16-316-833	AMD-P	92-09-150
16-230-864	NEW	92-13-035	16-231-315	AMD-E	92-08-028	16-316-833	AMD	92-13-027
16-230-865	REP-P	92-03-134	16-231-910	AMD-E	92-08-028	16-316-980	AMD-P	92-09-150
16-230-865	REP-S	92-07-059	16-231-912	AMD-E	92-08-028	16-316-980	AMD	92-13-027
16-230-865	REP-E	92-07-060	16-232-010	AMD-E	92-08-028	16-316-995	AMD-P	92-09-150
16-230-865	RESCIND	92-08-026	16-232-015	AMD-E	92-08-028	16-316-995	AMD	92-13-027
16-230-865	REP-E	92-08-027	16-232-020	AMD-E	92-08-028	16-316-997	AMD-P	92-09-150
16-230-865	REP	92-13-035	16-232-027	AMD-E	92-08-028	16-316-997	AMD	92-13-027
16-230-866	NEW-P	92-03-134	16-304-110	AMD-P	92-09-150	16-328-010	AMD-P	92-12-056
16-230-866	NEW-S	92-07-059	16-304-110	AMD	92-13-027	16-328-010	AMD	92-15-114
16-230-866	NEW-E	92-07-060	16-304-130	AMD-P	92-09-150	16-333-040	AMD-P	92-12-056
16-230-866	RESCIND	92-08-026	16-304-130	AMD	92-13-027	16-333-040	AMD	92-15-114
16-230-866	NEW-E	92-08-027	16-316-235	AMD-P	92-09-150	16-400-210	AMD-E	92-04-032
16-230-866	NEW	92-13-035	16-316-235	AMD	92-13-027	16-400-210	AMD	92-06-022
16-230-867	NEW-P	92-03-134	16-316-240	AMD-P	92-09-150	16-401-040	AMD-P	92-10-040
16-230-868	NEW-P	92-03-134	16-316-240	AMD	92-13-027	16-401-040	AMD	92-13-034
16-230-868	NEW-S	92-07-059	16-316-245	AMD-P	92-09-150	16-403-143	NEW-P	92-11-074
16-230-868	NEW-E	92-07-060	16-316-245	AMD	92-13-027	16-403-143	NEW	92-15-056
16-230-868	RESCIND	92-08-026	16-316-250	AMD-P	92-09-150	16-403-160	AMD-P	92-11-074
16-230-868	NEW-E	92-08-027	16-316-250	AMD	92-13-027	16-403-160	AMD	92-15-056
16-230-868	NEW	92-13-035	16-316-266	NEW-E	92-06-048	16-403-190	AMD-P	92-11-074
16-230-870	NEW-P	92-03-134	16-316-266	NEW-P	92-09-075	16-403-190	AMD	92-15-056
16-230-870	NEW-S	92-07-059	16-316-266	NEW	92-12-025	16-403-200	AMD-P	92-11-074
16-230-870	NEW-E	92-07-060	16-316-270	AMD-E	92-06-048	16-403-200	AMD	92-15-056
16-230-870	RESCIND	92-08-026	16-316-270	AMD-P	92-09-075	16-403-220	AMD-P	92-11-074
16-230-870	NEW-E	92-08-027	16-316-270	AMD	92-12-025	16-403-220	AMD	92-15-056
16-230-870	NEW	92-13-035	16-316-280	AMD-E	92-06-048	16-403-240	AMD-P	92-11-074
16-231	REP-C	92-07-005	16-316-280	AMD-P	92-09-075	16-403-240	AMD	92-15-056
16-231-001	REP-P	92-03-134	16-316-280	AMD	92-12-025	16-436-100	AMD-P	92-08-106
16-231-001	REP-S	92-07-059	16-316-285	AMD-E	92-06-048	16-436-100	AMD	92-11-076
16-231-001	REP-E	92-07-060	16-316-285	AMD-P	92-09-075	16-436-110	AMD-P	92-08-106
16-231-001	RESCIND	92-08-026	16-316-285	AMD	92-12-025	16-436-110	AMD	92-11-076
16-231-001	REP-E	92-08-027	16-316-290	AMD-E	92-06-048	16-436-130	REP-P	92-08-106
16-231-001	REP	92-13-035	16-316-290	AMD-P	92-09-075	16-436-130	REP	92-11-076
16-231-005	REP-P	92-03-134	16-316-290	AMD	92-12-025	16-436-140	AMD-P	92-08-106
16-231-005	REP-S	92-07-059	16-316-315	AMD-P	92-09-150	16-436-140	AMD	92-11-076
16-231-005	REP-E	92-07-060	16-316-315	AMD	92-13-027	16-436-150	AMD-P	92-08-106
16-231-005	RESCIND	92-08-026	16-316-327	AMD-P	92-09-150	16-436-150	AMD	92-11-076
16-231-005	REP-E	92-08-027	16-316-327	AMD	92-13-027	16-436-166	NEW-P	92-08-106

Table of WAC Sections Affected

WAC #	WSR #	WAC #	WSR #	WAC #	WSR #			
16-436-166	NEW	92-11-076	16-494-110	NEW	92-12-025	16-674-060	NEW-E	92-14-122
16-436-170	REP-P	92-08-106	16-494-120	NEW-E	92-06-049	16-674-060	NEW-P	92-14-123
16-436-170	REP	92-11-076	16-494-120	NEW-P	92-09-075	16-674-070	NEW-E	92-14-122
16-436-185	AMD-P	92-08-106	16-494-120	NEW	92-12-025	16-674-070	NEW-P	92-14-123
16-436-185	AMD	92-11-076	16-494-130	NEW-E	92-06-049	16-674-080	NEW-E	92-14-122
16-436-186	NEW-P	92-08-106	16-494-130	NEW-P	92-09-075	16-674-080	NEW-P	92-14-123
16-436-186	NEW	92-11-076	16-494-130	NEW	92-12-025	16-752-500	NEW-P	92-03-105
16-436-187	NEW-P	92-08-106	16-494-140	NEW-E	92-06-049	16-752-500	NEW	92-07-024
16-436-187	NEW	92-11-076	16-494-140	NEW-P	92-09-075	16-752-505	NEW-P	92-03-105
16-436-190	AMD-P	92-08-106	16-494-140	NEW	92-12-025	16-752-505	NEW	92-07-024
16-436-190	AMD	92-11-076	16-494-150	NEW-E	92-06-049	16-752-507	NEW	92-07-024
16-436-200	AMD-P	92-08-106	16-494-150	NEW-P	92-09-075	16-752-510	NEW-P	92-03-105
16-436-200	AMD	92-11-076	16-494-150	NEW	92-12-025	16-752-510	NEW	92-07-024
16-436-210	AMD-P	92-08-106	16-494-160	NEW-E	92-06-049	16-752-515	NEW-P	92-03-105
16-436-210	AMD	92-11-076	16-494-160	NEW-P	92-09-075	16-752-515	NEW	92-07-024
16-436-220	AMD-P	92-08-106	16-494-160	NEW	92-12-025	16-752-520	NEW-P	92-03-105
16-436-220	AMD	92-11-076	16-494-170	NEW-E	92-06-049	16-752-520	NEW	92-07-024
16-436-225	NEW-P	92-08-106	16-494-170	NEW-P	92-09-075	16-752-525	NEW-P	92-03-105
16-436-225	NEW	92-11-076	16-494-170	NEW	92-12-025	16-752-525	NEW	92-07-024
16-461	AMD	92-06-085	16-495-004	AMD-P	92-09-150	16-752-600	NEW-P	92-03-106
16-461-006	NEW	92-06-085	16-495-004	AMD	92-13-027	16-752-600	NEW	92-07-025
16-461-006	AMD-E	92-13-064	16-495-010	AMD-P	92-09-150	16-752-605	NEW	92-07-025
16-461-006	AMD-P	92-15-117	16-495-010	AMD	92-13-027	16-752-610	NEW-P	92-03-106
16-461-010	AMD	92-06-085	16-495-050	AMD-P	92-09-150	16-752-610	NEW	92-07-025
16-461-010	AMD-E	92-13-064	16-495-050	AMD	92-13-027	16-752-620	NEW-P	92-03-106
16-461-010	AMD-P	92-15-117	16-495-110	AMD-P	92-09-150	16-752-620	NEW	92-07-025
16-469-010	REP-P	92-09-074	16-495-110	AMD	92-13-027	16-752-630	NEW-P	92-03-106
16-469-010	REP	92-13-050	16-520-040	AMD-P	92-15-107	16-752-630	NEW	92-07-025
16-469-020	REP-P	92-09-074	16-532-010	AMD-P	92-06-071	16-752-640	NEW-P	92-03-106
16-469-020	REP	92-13-050	16-532-010	AMD	92-09-068	16-752-640	NEW	92-07-025
16-469-030	REP-P	92-09-074	16-532-020	AMD-P	92-06-071	16-752-650	NEW-P	92-03-106
16-469-030	REP	92-13-050	16-532-020	AMD	92-09-068	16-752-650	NEW	92-07-025
16-469-040	REP-P	92-09-074	16-532-030	AMD-P	92-06-071	16-752-660	NEW-P	92-03-106
16-469-040	REP	92-13-050	16-532-030	AMD	92-09-068	16-752-660	NEW	92-07-025
16-469-050	REP-P	92-09-074	16-532-065	NEW-P	92-06-071	44-10-010	AMD	92-11-037
16-469-050	REP	92-13-050	16-532-065	NEW	92-09-068	44-10-020	NEW-W	92-11-036
16-469-060	REP-P	92-09-074	16-532-110	AMD-P	92-06-071	44-10-060	AMD	92-11-037
16-469-060	REP	92-13-050	16-532-110	AMD	92-09-068	44-10-205	NEW-W	92-11-036
16-470-500	REP	92-06-024	16-555-020	AMD-P	92-05-071	50-12-116	AMD	92-04-027
16-470-510	REP	92-06-024	16-555-020	AMD-E	92-12-004	50-14-020	NEW	92-06-041
16-470-520	REP	92-06-024	16-555-020	AMD	92-12-006	50-14-030	NEW	92-06-041
16-470-530	REP	92-06-024	16-555-040	AMD-P	92-05-071	50-14-040	NEW	92-06-041
16-470-600	REP	92-06-023	16-555-040	AMD-E	92-12-004	50-14-050	NEW	92-06-041
16-470-605	REP	92-06-023	16-555-040	AMD	92-12-006	50-14-060	NEW	92-06-041
16-470-610	REP	92-06-023	16-561-020	AMD-P	92-05-070	50-14-070	NEW	92-06-041
16-470-615	REP	92-06-023	16-561-020	AMD	92-12-003	50-14-080	NEW	92-06-041
16-470-620	REP	92-06-023	16-570-030	AMD-P	92-08-055	50-14-090	NEW	92-06-041
16-470-625	REP	92-06-023	16-570-030	AMD	92-11-013	50-14-100	NEW	92-06-041
16-470-630	REP	92-06-023	16-580-010	NEW-P	92-14-117	50-14-110	NEW	92-06-041
16-470-635	REP	92-06-023	16-580-020	NEW-P	92-14-117	50-14-120	NEW	92-06-041
16-470-900	NEW-P	92-03-104	16-580-030	NEW-P	92-14-117	50-14-130	NEW	92-06-041
16-470-900	NEW	92-07-023	16-580-040	NEW-P	92-14-117	50-14-140	NEW	92-06-041
16-470-905	NEW-P	92-03-104	16-580-041	NEW-P	92-14-117	50-14-150	NEW-W	92-14-110
16-470-905	NEW	92-07-023	16-580-050	NEW-P	92-14-117	50-30-010	NEW	92-02-105
16-470-910	NEW-P	92-03-104	16-580-060	NEW-P	92-14-117	50-30-020	NEW	92-02-105
16-470-910	NEW	92-07-023	16-580-070	NEW-P	92-14-117	50-30-030	NEW	92-02-105
16-470-915	NEW-P	92-03-104	16-580-080	NEW-P	92-14-117	50-30-040	NEW	92-02-105
16-470-915	NEW	92-07-023	16-604-010	AMD	92-06-013	50-30-050	NEW	92-02-105
16-470-920	NEW-P	92-03-104	16-604-015	NEW	92-06-013	50-30-060	NEW	92-02-105
16-470-920	NEW	92-07-023	16-622-050	AMD-P	92-03-069	50-30-070	NEW	92-02-105
16-494-010	AMD-E	92-06-050	16-622-050	AMD-E	92-03-070	50-30-080	NEW	92-02-105
16-494-010	AMD-P	92-09-075	16-622-050	AMD	92-07-030	50-30-090	NEW	92-02-105
16-494-010	AMD	92-12-025	16-622-060	NEW-P	92-03-069	50-30-100	NEW	92-02-105
16-494-013	AMD-E	92-06-050	16-622-060	NEW-E	92-03-070	50-30-110	NEW	92-02-105
16-494-013	AMD-P	92-09-075	16-622-060	NEW	92-07-030	50-30-110	AMD-E	92-14-062
16-494-013	AMD	92-12-025	16-674-002	REP-E	92-14-122	50-30-110	AMD-P	92-14-109
16-494-046	AMD-E	92-06-050	16-674-002	REP-P	92-14-123	51-13-502	AMD-E	92-14-002
16-494-046	AMD-P	92-09-075	16-674-010	AMD-E	92-14-122	51-20-0419	NEW-W	92-09-110
16-494-046	AMD	92-12-025	16-674-010	AMD-P	92-14-123	51-20-0504	NEW-W	92-09-110
16-494-064	AMD-E	92-06-050	16-674-020	AMD-E	92-14-122	51-20-0516	NEW-W	92-09-110
16-494-064	AMD-P	92-09-075	16-674-020	AMD-P	92-14-123	51-20-0554	NEW-W	92-09-110
16-494-064	AMD	92-12-025	16-674-030	AMD-E	92-14-122	51-20-0555	NEW-W	92-09-110
16-494-100	NEW-E	92-06-049	16-674-030	AMD-P	92-14-123	51-20-0610	NEW-W	92-09-110
16-494-100	NEW-P	92-09-075	16-674-040	AMD-E	92-14-122	51-20-1216	NEW-W	92-09-110
16-494-100	NEW	92-12-025	16-674-040	AMD-P	92-14-123	51-20-1251	NEW-W	92-09-110
16-494-110	NEW-E	92-06-049	16-674-055	NEW-E	92-14-122	51-20-3200	NEW-W	92-09-110
16-494-110	NEW-P	92-09-075	16-674-055	NEW-P	92-14-123	51-20-3207	NEW-W	92-09-110



Table of WAC Sections Affected

WAC #	WSR #	WAC #	WSR #	WAC #	WSR #
51-20-3305	NEW-W 92-09-110	132B-104-010	NEW 92-08-043	132H-106-030	NEW-P 92-09-057
51-20-91200	NEW-W 92-09-110	132B-108	NEW-C 92-07-063	132H-106-030	NEW 92-13-093
51-20-91223	NEW-W 92-09-110	132B-108-010	NEW 92-09-041	132H-106-040	NEW-E 92-07-071
51-20-91224	NEW-W 92-09-110	132B-108-020	NEW 92-09-041	132H-106-040	NEW-P 92-09-057
51-20-91225	NEW-W 92-09-110	132B-108-030	NEW 92-09-041	132H-106-040	NEW 92-13-093
51-20-91226	NEW-W 92-09-110	132B-108-040	NEW 92-09-041	132H-106-050	NEW-E 92-07-071
51-20-91227	NEW-W 92-09-110	132B-108-050	NEW 92-09-041	132H-106-050	NEW-P 92-09-057
51-20-91228	NEW-W 92-09-110	132B-108-060	NEW 92-09-041	132H-106-050	NEW 92-13-093
51-20-91229	NEW-W 92-09-110	132B-108-070	NEW 92-09-041	132H-106-060	NEW-E 92-07-071
51-20-91230	NEW-W 92-09-110	132B-108-080	NEW 92-09-041	132H-106-060	NEW-P 92-09-057
51-20-91231	NEW-W 92-09-110	132B-130	NEW-C 92-07-065	132H-106-060	NEW 92-13-093
51-20-91232	NEW-W 92-09-110	132B-130-010	NEW 92-08-044	132H-112-003	REP-E 92-07-074
51-20-91233	NEW-W 92-09-110	132B-130-020	NEW 92-08-044	132H-112-003	REP-P 92-09-058
51-20-91234	NEW-W 92-09-110	132B-131	NEW-C 92-07-065	132H-112-003	REP 92-13-094
51-20-93121	NEW-W 92-05-086	132B-131-010	NEW 92-08-044	132H-112-006	REP-E 92-07-074
51-24-79809	NEW-P 92-09-156	132B-132	NEW-C 92-07-065	132H-112-006	REP-P 92-09-058
51-24-79901	NEW-P 92-09-156	132B-132-010	NEW 92-08-044	132H-112-006	REP 92-13-094
51-24-99300	NEW-W 92-05-087	132B-133	NEW-C 92-07-064	132H-112-009	REP-E 92-07-074
51-24-99350	NEW-W 92-05-087	132B-133-010	NEW 92-08-043	132H-112-009	REP-P 92-09-058
51-24-99351	NEW-W 92-05-087	132B-133-020	NEW 92-08-043	132H-112-009	REP 92-13-094
51-24-99352	NEW-W 92-05-087	132G-152-040	NEW-P 92-04-055	132H-112-012	REP-E 92-07-074
55-01-010	AMD-P 92-09-157	132G-152-040	NEW 92-08-040	132H-112-012	REP-P 92-09-058
55-01-010	AMD 92-14-088	132H-105-010	REP-E 92-07-071	132H-112-012	REP 92-13-094
55-01-020	AMD-P 92-09-157	132H-105-010	REP-P 92-09-057	132H-112-015	REP-E 92-07-074
55-01-020	AMD-E 92-14-087	132H-105-010	REP 92-13-093	132H-112-015	REP-P 92-09-058
55-01-020	AMD 92-14-097	132H-105-020	REP-E 92-07-071	132H-112-015	REP 92-13-094
55-01-030	AMD-P 92-09-157	132H-105-020	REP-P 92-09-057	132H-112-018	REP-E 92-07-074
55-01-030	AMD 92-14-088	132H-105-020	REP 92-13-093	132H-112-018	REP-P 92-09-058
55-01-050	AMD-P 92-09-157	132H-105-030	REP-E 92-07-071	132H-112-018	REP 92-13-094
55-01-050	AMD-E 92-14-087	132H-105-030	REP-P 92-09-057	132H-112-021	REP-E 92-07-074
55-01-050	AMD 92-14-097	132H-105-030	REP 92-13-093	132H-112-021	REP-P 92-09-058
55-01-060	AMD-P 92-09-157	132H-105-040	REP-E 92-07-071	132H-112-021	REP 92-13-094
55-01-060	AMD-E 92-14-087	132H-105-040	REP-P 92-09-057	132H-112-024	REP-E 92-07-074
55-01-060	AMD 92-14-097	132H-105-040	REP 92-13-093	132H-112-024	REP-P 92-09-058
67-25-446	AMD-P 92-06-036	132H-105-050	REP-E 92-07-071	132H-112-024	REP 92-13-094
67-25-446	AMD 92-09-090	132H-105-050	REP-P 92-09-057	132H-112-027	REP-E 92-07-074
67-35-030	AMD-P 92-07-011	132H-105-050	REP 92-13-093	132H-112-027	REP-P 92-09-058
67-35-030	AMD 92-10-024	132H-105-060	REP-E 92-07-071	132H-112-027	REP 92-13-094
67-35-060	AMD-P 92-07-011	132H-105-060	REP-P 92-09-057	132H-112-030	REP-E 92-07-074
67-35-060	AMD 92-10-024	132H-105-060	REP 92-13-093	132H-112-030	REP-P 92-09-058
67-35-070	AMD-P 92-07-011	132H-105-070	REP-E 92-07-071	132H-112-030	REP 92-13-094
67-35-070	AMD-E 92-07-012	132H-105-070	REP-P 92-09-057	132H-112-033	REP-E 92-07-074
67-35-070	AMD 92-10-024	132H-105-070	REP 92-13-093	132H-112-033	REP-P 92-09-058
67-35-080	REP-P 92-07-011	132H-105-090	REP-E 92-07-071	132H-112-033	REP 92-13-094
67-35-080	REP-E 92-07-012	132H-105-090	REP-P 92-09-057	132H-112-036	REP-E 92-07-074
67-35-080	REP 92-10-024	132H-105-090	REP 92-13-093	132H-112-036	REP-P 92-09-058
67-75-040	AMD-P 92-06-036	132H-105-100	REP-E 92-07-071	132H-112-036	REP 92-13-094
67-75-040	AMD 92-09-090	132H-105-100	REP-P 92-09-057	132H-112-039	REP-E 92-07-074
67-75-042	NEW-P 92-06-036	132H-105-100	REP 92-13-093	132H-112-039	REP-P 92-09-058
67-75-042	NEW 92-09-090	132H-105-110	REP-E 92-07-071	132H-112-039	REP 92-13-094
67-75-044	NEW-P 92-06-036	132H-105-110	REP-P 92-09-057	132H-112-042	REP-E 92-07-074
67-75-044	NEW 92-09-090	132H-105-110	REP 92-13-093	132H-112-042	REP-P 92-09-058
67-75-070	AMD-P 92-06-036	132H-105-120	REP-E 92-07-071	132H-112-042	REP 92-13-094
67-75-070	AMD 92-09-090	132H-105-120	REP-P 92-09-057	132H-112-045	REP-E 92-07-074
67-75-075	AMD-P 92-06-036	132H-105-120	REP 92-13-093	132H-112-045	REP-P 92-09-058
67-75-075	AMD 92-09-090	132H-105-130	REP-E 92-07-071	132H-112-045	REP 92-13-094
131-08-005	AMD-P 92-09-138	132H-105-130	REP-P 92-09-057	132H-112-048	REP-E 92-07-074
131-08-005	AMD 92-13-019	132H-105-130	REP 92-13-093	132H-112-048	REP-P 92-09-058
131-08-007	AMD-P 92-09-138	132H-105-140	REP-E 92-07-071	132H-112-048	REP 92-13-094
131-08-007	AMD 92-13-019	132H-105-140	REP-P 92-09-057	132H-112-051	REP-E 92-07-074
131-08-008	AMD-P 92-09-138	132H-105-140	REP 92-13-093	132H-112-051	REP-P 92-09-058
131-08-008	AMD 92-13-019	132H-105-150	REP-E 92-07-071	132H-112-051	REP 92-13-094
131-16-060	AMD-P 92-09-139	132H-105-150	REP-P 92-09-057	132H-112-054	REP-E 92-07-074
131-16-060	AMD-W 92-12-085	132H-105-150	REP 92-13-093	132H-112-054	REP-P 92-09-058
131-16-062	AMD-P 92-09-139	132H-105-160	REP-E 92-07-071	132H-112-054	REP 92-13-094
131-28-025	AMD-E 92-10-033	132H-105-160	REP-P 92-09-057	132H-112-057	REP-E 92-07-074
131-28-025	AMD-P 92-10-042	132H-105-160	REP 92-13-093	132H-112-057	REP-P 92-09-058
131-28-025	AMD 92-14-033	132H-105-170	REP-E 92-07-071	132H-112-057	REP 92-13-094
131-28-026	AMD-E 92-10-033	132H-105-170	REP-P 92-09-057	132H-112-060	REP-E 92-07-074
131-28-026	AMD-P 92-10-042	132H-105-170	REP 92-13-093	132H-112-060	REP-P 92-09-058
131-28-026	AMD 92-14-033	132H-106-010	NEW-E 92-07-071	132H-112-060	REP 92-13-094
131-28-028	NEW-E 92-10-033	132H-106-010	NEW-P 92-09-057	132H-112-063	REP-E 92-07-074
131-28-028	NEW-P 92-10-042	132H-106-010	NEW 92-13-093	132H-112-063	REP-P 92-09-058
131-28-028	NEW 92-14-033	132H-106-020	NEW-E 92-07-071	132H-112-063	REP 92-13-094
131-32-040	AMD-P 92-09-140	132H-106-020	NEW-P 92-09-057	132H-116-300	AMD-P 92-09-062
131-32-040	AMD 92-13-020	132H-106-020	NEW 92-13-093	132H-116-300	AMD-E 92-09-063
132B-104	NEW-C 92-07-064	132H-106-030	NEW-E 92-07-071	132H-116-300	AMD 92-13-097

Table of WAC Sections Affected

WAC #	WSR #	WAC #	WSR #	WAC #	WSR #			
132H-116-310	AMD-P	92-09-062	132H-116-433	NEW	92-13-097	132H-116-670	REP-E	92-09-063
132H-116-310	AMD-E	92-09-063	132H-116-440	REP-P	92-09-062	132H-116-670	REP	92-13-097
132H-116-310	AMD	92-13-097	132H-116-440	REP-E	92-09-063	132H-116-680	REP-P	92-09-062
132H-116-315	NEW-P	92-09-062	132H-116-440	REP	92-13-097	132H-116-680	REP-E	92-09-063
132H-116-315	NEW-E	92-09-063	132H-116-450	REP-P	92-09-062	132H-116-680	REP	92-13-097
132H-116-315	NEW	92-13-097	132H-116-450	REP-E	92-09-063	132H-116-690	REP-P	92-09-062
132H-116-320	AMD-P	92-09-062	132H-116-450	REP	92-13-097	132H-116-690	REP-E	92-09-063
132H-116-320	AMD-E	92-09-063	132H-116-470	AMD-P	92-09-062	132H-116-690	REP	92-13-097
132H-116-320	AMD	92-13-097	132H-116-470	AMD-E	92-09-063	132H-116-700	REP-P	92-09-062
132H-116-330	AMD-P	92-09-062	132H-116-470	AMD	92-13-097	132H-116-700	REP-E	92-09-063
132H-116-330	AMD-E	92-09-063	132H-116-480	REP-P	92-09-062	132H-116-700	REP	92-13-097
132H-116-330	AMD	92-13-097	132H-116-480	REP-E	92-09-063	132H-116-710	REP-P	92-09-062
132H-116-340	REP-P	92-09-062	132H-116-480	REP	92-13-097	132H-116-710	REP-E	92-09-063
132H-116-340	REP-E	92-09-063	132H-116-490	REP-P	92-09-062	132H-116-710	REP	92-13-097
132H-116-340	REP	92-13-097	132H-116-490	REP-E	92-09-063	132H-116-720	REP-P	92-09-062
132H-116-350	AMD-P	92-09-062	132H-116-490	REP	92-13-097	132H-116-720	REP-E	92-09-063
132H-116-350	AMD-E	92-09-063	132H-116-500	REP-P	92-09-062	132H-116-720	REP	92-13-097
132H-116-350	AMD	92-13-097	132H-116-500	REP-E	92-09-063	132H-116-730	AMD-P	92-09-062
132H-116-351	NEW-P	92-09-062	132H-116-500	REP	92-13-097	132H-116-730	AMD-E	92-09-063
132H-116-351	NEW-E	92-09-063	132H-116-510	REP-P	92-09-062	132H-116-730	AMD	92-13-097
132H-116-351	NEW	92-13-097	132H-116-510	REP-E	92-09-063	132H-116-740	REP-P	92-09-062
132H-116-352	NEW-P	92-09-062	132H-116-510	REP	92-13-097	132H-116-740	REP-E	92-09-063
132H-116-352	NEW-E	92-09-063	132H-116-520	REP-P	92-09-062	132H-116-740	REP	92-13-097
132H-116-352	NEW	92-13-097	132H-116-520	REP-E	92-09-063	132H-116-750	AMD-P	92-09-062
132H-116-353	NEW-P	92-09-062	132H-116-520	REP	92-13-097	132H-116-750	AMD-E	92-09-063
132H-116-353	NEW-E	92-09-063	132H-116-530	REP-P	92-09-062	132H-116-750	AMD	92-13-097
132H-116-353	NEW	92-13-097	132H-116-530	REP-E	92-09-063	132H-116-760	REP-P	92-09-062
132H-116-354	NEW-P	92-09-062	132H-116-530	REP	92-13-097	132H-116-760	REP-E	92-09-063
132H-116-354	NEW-E	92-09-063	132H-116-540	REP-P	92-09-062	132H-116-760	REP	92-13-097
132H-116-354	NEW	92-13-097	132H-116-540	REP-E	92-09-063	132H-116-765	NEW-P	92-09-062
132H-116-355	NEW-P	92-09-062	132H-116-540	REP	92-13-097	132H-116-765	NEW-E	92-09-063
132H-116-355	NEW-E	92-09-063	132H-116-542	REP-P	92-09-062	132H-116-765	NEW	92-13-097
132H-116-355	NEW	92-13-097	132H-116-542	REP-E	92-09-063	132H-116-770	REP-P	92-09-062
132H-116-356	NEW-P	92-09-062	132H-116-542	REP	92-13-097	132H-116-770	REP-E	92-09-063
132H-116-356	NEW-E	92-09-063	132H-116-550	REP-P	92-09-062	132H-116-770	REP	92-13-097
132H-116-356	NEW	92-13-097	132H-116-550	REP-E	92-09-063	132H-116-780	REP-P	92-09-062
132H-116-357	NEW-P	92-09-062	132H-116-550	REP	92-13-097	132H-116-780	REP-E	92-09-063
132H-116-357	NEW-E	92-09-063	132H-116-560	REP-P	92-09-062	132H-116-780	REP	92-13-097
132H-116-357	NEW	92-13-097	132H-116-560	REP-E	92-09-063	132H-116-791	NEW-P	92-09-062
132H-116-360	AMD-P	92-09-062	132H-116-560	REP	92-13-097	132H-116-791	NEW-E	92-09-063
132H-116-360	AMD-E	92-09-063	132H-116-570	REP-P	92-09-062	132H-116-791	NEW	92-13-097
132H-116-360	AMD	92-13-097	132H-116-570	REP-E	92-09-063	132H-116-810	REP-P	92-09-062
132H-116-370	REP-P	92-09-062	132H-116-570	REP	92-13-097	132H-116-810	REP-E	92-09-063
132H-116-370	REP-E	92-09-063	132H-116-580	REP-P	92-09-062	132H-116-810	REP	92-13-097
132H-116-370	REP	92-13-097	132H-116-580	REP-E	92-09-063	132H-120-010	AMD-P	92-14-061
132H-116-380	REP-P	92-09-062	132H-116-580	REP	92-13-097	132H-120-010	AMD-E	92-14-075
132H-116-380	REP-E	92-09-063	132H-116-590	AMD-P	92-09-062	132H-120-020	AMD-P	92-14-061
132H-116-380	REP	92-13-097	132H-116-590	AMD-E	92-09-063	132H-120-020	AMD-E	92-14-075
132H-116-390	REP-P	92-09-062	132H-116-590	AMD	92-13-097	132H-120-030	AMD-P	92-14-061
132H-116-390	REP-E	92-09-063	132H-116-600	REP-P	92-09-062	132H-120-030	AMD-E	92-14-075
132H-116-390	REP	92-13-097	132H-116-600	REP-E	92-09-063	132H-120-040	AMD-P	92-14-061
132H-116-400	REP-P	92-09-062	132H-116-600	REP	92-13-097	132H-120-040	AMD-E	92-14-075
132H-116-400	REP-E	92-09-063	132H-116-610	REP-P	92-09-062	132H-120-050	AMD-P	92-14-061
132H-116-400	REP	92-13-097	132H-116-610	REP-E	92-09-063	132H-120-050	AMD-E	92-14-075
132H-116-405	NEW-P	92-09-062	132H-116-610	REP	92-13-097	132H-120-062	REP-P	92-14-061
132H-116-405	NEW-E	92-09-063	132H-116-615	NEW-P	92-09-062	132H-120-062	REP-E	92-14-075
132H-116-405	NEW	92-13-097	132H-116-615	NEW-E	92-09-063	132H-120-070	REP-P	92-14-061
132H-116-410	AMD-P	92-09-062	132H-116-615	NEW	92-13-097	132H-120-070	REP-E	92-14-075
132H-116-410	AMD-E	92-09-063	132H-116-620	AMD-P	92-09-062	132H-120-072	REP-P	92-14-061
132H-116-410	AMD	92-13-097	132H-116-620	AMD-E	92-09-063	132H-120-072	REP-E	92-14-075
132H-116-415	NEW-P	92-09-062	132H-116-620	AMD	92-13-097	132H-120-073	REP-P	92-14-061
132H-116-415	NEW-E	92-09-063	132H-116-630	AMD-P	92-09-062	132H-120-073	REP-E	92-14-075
132H-116-415	NEW	92-13-097	132H-116-630	AMD-E	92-09-063	132H-120-075	REP-P	92-14-061
132H-116-420	REP-P	92-09-062	132H-116-630	AMD	92-13-097	132H-120-075	REP-E	92-14-075
132H-116-420	REP-E	92-09-063	132H-116-640	REP-P	92-09-062	132H-120-077	REP-P	92-14-061
132H-116-420	REP	92-13-097	132H-116-640	REP-E	92-09-063	132H-120-077	REP-E	92-14-075
132H-116-430	AMD-P	92-09-062	132H-116-640	REP	92-13-097	132H-120-078	REP-P	92-14-061
132H-116-430	AMD-E	92-09-063	132H-116-650	REP-P	92-09-062	132H-120-078	REP-E	92-14-075
132H-116-430	AMD	92-13-097	132H-116-650	REP-E	92-09-063	132H-120-079	REP-P	92-14-061
132H-116-431	NEW-P	92-09-062	132H-116-650	REP	92-13-097	132H-120-079	REP-E	92-14-075
132H-116-431	NEW-E	92-09-063	132H-116-655	NEW-P	92-09-062	132H-120-080	REP-P	92-14-061
132H-116-431	NEW	92-13-097	132H-116-655	NEW-E	92-09-063	132H-120-080	REP-E	92-14-075
132H-116-432	NEW-P	92-09-062	132H-116-655	NEW	92-13-097	132H-120-090	REP-P	92-14-061
132H-116-432	NEW-E	92-09-063	132H-116-660	REP-P	92-09-062	132H-120-090	REP-E	92-14-075
132H-116-432	NEW	92-13-097	132H-116-660	REP-E	92-09-063	132H-120-100	REP-P	92-14-061
132H-116-433	NEW-P	92-09-062	132H-116-660	REP	92-13-097	132H-120-100	REP-E	92-14-075
132H-116-433	NEW-E	92-09-063	132H-116-670	REP-P	92-09-062	132H-120-110	REP-P	92-14-061

Table of WAC Sections Affected

WAC #	WSR #	WAC #	WSR #	WAC #	WSR #			
132H-120-110	REP-E	92-14-075	132H-128-040	REP-P	92-09-059	132I-112-050	REP	92-15-115
132H-120-120	REP-P	92-14-061	132H-128-040	REP	92-13-095	132I-112-060	REP-P	92-09-152
132H-120-120	REP-E	92-14-075	132H-131-010	NEW-P	92-15-067	132I-112-060	REP	92-15-115
132H-120-130	REP-P	92-14-061	132H-131-020	NEW-P	92-15-067	132I-112-070	REP-P	92-09-152
132H-120-130	REP-E	92-14-075	132H-132-020	AMD-P	92-15-073	132I-112-070	REP	92-15-115
132H-120-200	AMD-P	92-14-061	132H-133-010	NEW-P	92-15-063	132I-112-080	REP-P	92-09-152
132H-120-200	AMD-E	92-14-075	132H-133-020	NEW-P	92-15-063	132I-112-080	REP	92-15-115
132H-120-205	REP-P	92-14-061	132H-133-040	NEW-P	92-15-063	132I-112-090	REP-P	92-09-152
132H-120-205	REP-E	92-14-075	132H-133-050	NEW-P	92-15-063	132I-112-090	REP	92-15-115
132H-120-220	AMD-P	92-14-061	132H-136-030	AMD-P	92-16-066	132I-112-100	REP-P	92-09-152
132H-120-220	AMD-E	92-14-075	132H-136-035	NEW-P	92-16-066	132I-112-100	REP	92-15-115
132H-120-225	NEW-P	92-14-061	132H-148-010	REP-E	92-07-073	132I-112-110	REP-P	92-09-152
132H-120-225	NEW-E	92-14-075	132H-148-010	REP-P	92-09-060	132I-112-110	REP	92-15-115
132H-120-230	REP-P	92-14-061	132H-148-010	REP	92-13-096	132I-112-120	REP-P	92-09-152
132H-120-230	REP-E	92-14-075	132H-148-110	REP-E	92-07-073	132I-112-120	REP	92-15-115
132H-120-235	NEW-P	92-14-061	132H-148-110	REP-P	92-09-060	132I-112-130	REP-P	92-09-152
132H-120-235	NEW-E	92-14-075	132H-148-110	REP	92-13-096	132I-112-130	REP	92-15-115
132H-120-240	REP-P	92-14-061	132H-200-010	REP-P	92-15-062	132I-112-140	REP-P	92-09-152
132H-120-240	REP-E	92-14-075	132H-200-020	REP-P	92-15-062	132I-112-140	REP	92-15-115
132H-120-245	NEW-P	92-14-061	132H-200-040	REP-P	92-15-062	132I-112-150	REP-P	92-09-152
132H-120-245	NEW-E	92-14-075	132H-200-100	REP-P	92-15-062	132I-112-150	REP	92-15-115
132H-120-300	AMD-P	92-14-061	132H-200-110	REP-P	92-15-062	132I-112-160	REP-P	92-09-152
132H-120-300	AMD-E	92-14-075	132H-200-200	REP-P	92-15-062	132I-112-160	REP	92-15-115
132H-120-305	NEW-P	92-14-061	132H-200-250	REP-P	92-15-062	132I-112-170	REP-P	92-09-152
132H-120-305	NEW-E	92-14-075	132I-104-010	REP-P	92-09-152	132I-112-170	REP	92-15-115
132H-120-310	AMD-P	92-14-061	132I-104-010	REP	92-15-115	132I-112-180	REP-P	92-09-152
132H-120-310	AMD-E	92-14-075	132I-104-030	AMD-P	92-09-152	132I-112-180	REP	92-15-115
132H-120-320	REP-P	92-14-061	132I-104-030	AMD	92-15-115	132I-112-190	REP-P	92-09-152
132H-120-320	REP-E	92-14-075	132I-104-040	AMD-P	92-09-152	132I-112-190	REP	92-15-115
132H-120-330	REP-P	92-14-061	132I-104-040	AMD	92-15-115	132I-112-200	REP-P	92-09-152
132H-120-330	REP-E	92-14-075	132I-104-050	REP-P	92-09-152	132I-112-200	REP	92-15-115
132H-120-335	NEW-P	92-14-061	132I-104-050	REP	92-15-115	132I-112-210	REP-P	92-09-152
132H-120-335	NEW-E	92-14-075	132I-104-060	REP-P	92-09-152	132I-112-210	REP	92-15-115
132H-120-340	REP-P	92-14-061	132I-104-060	REP	92-15-115	132I-112-220	REP-P	92-09-152
132H-120-340	REP-E	92-14-075	132I-104-065	NEW-P	92-09-152	132I-112-220	REP	92-15-115
132H-120-350	AMD-P	92-14-061	132I-104-065	NEW	92-15-115	132I-112-230	REP-P	92-09-152
132H-120-350	AMD-E	92-14-075	132I-104-070	REP-P	92-09-152	132I-112-230	REP	92-15-115
132H-120-360	AMD-P	92-14-061	132I-104-070	REP	92-15-115	132I-112-240	REP-P	92-09-152
132H-120-360	AMD-E	92-14-075	132I-104-080	AMD-P	92-09-152	132I-112-240	REP	92-15-115
132H-120-360	AMD-E	92-14-061	132I-104-080	AMD	92-15-115	132I-116-010	AMD-P	92-09-152
132H-120-400	REP-P	92-14-061	132I-104-090	AMD-P	92-09-152	132I-116-010	AMD	92-15-115
132H-120-400	REP-E	92-14-075	132I-104-090	AMD	92-15-115	132I-116-090	AMD-P	92-09-152
132H-120-405	NEW-P	92-14-061	132I-104-110	AMD-P	92-09-152	132I-116-090	AMD	92-15-115
132H-120-405	NEW-E	92-14-075	132I-104-110	AMD	92-15-115	132I-116-270	AMD-P	92-09-152
132H-120-410	AMD-P	92-14-061	132I-108-010	NEW-P	92-09-152	132I-116-270	AMD	92-15-115
132H-120-410	AMD-E	92-14-075	132I-108-010	NEW	92-15-115	132I-116-275	NEW-P	92-09-152
132H-120-420	AMD-P	92-14-061	132I-108-020	NEW-P	92-09-152	132I-116-275	NEW	92-15-115
132H-120-420	AMD-E	92-14-075	132I-108-020	NEW	92-15-115	132I-116-280	AMD-P	92-09-152
132H-120-430	AMD-P	92-14-061	132I-108-030	NEW-P	92-09-152	132I-116-280	AMD	92-15-115
132H-120-430	AMD-E	92-14-075	132I-108-030	NEW	92-15-115	132I-116-285	NEW-P	92-09-152
132H-120-440	AMD-P	92-14-061	132I-108-040	NEW-P	92-09-152	132I-116-285	NEW	92-15-115
132H-120-440	AMD-E	92-14-075	132I-108-040	NEW	92-15-115	132I-116-300	AMD-P	92-09-152
132H-120-450	AMD-P	92-14-061	132I-108-050	NEW-P	92-09-152	132I-116-300	AMD	92-15-115
132H-120-450	AMD-E	92-14-075	132I-108-050	NEW	92-15-115	132I-120-020	AMD-P	92-09-152
132H-120-460	AMD-P	92-14-061	132I-108-060	NEW-P	92-09-152	132I-120-020	AMD	92-15-115
132H-120-460	AMD-E	92-14-075	132I-108-060	NEW	92-15-115	132I-120-100	AMD-P	92-09-152
132H-120-470	REP-P	92-14-061	132I-108-070	NEW-P	92-09-152	132I-120-100	AMD	92-15-115
132H-120-470	REP-E	92-14-075	132I-108-070	NEW	92-15-115	132I-120-105	NEW-P	92-09-152
132H-120-475	NEW-P	92-14-061	132I-108-070	NEW-P	92-09-152	132I-120-105	NEW	92-15-115
132H-120-475	NEW-E	92-14-075	132I-108-080	NEW	92-15-115	132I-120-300	REP-P	92-09-152
132H-120-480	REP-P	92-14-061	132I-108-080	NEW	92-15-115	132I-120-300	REP	92-15-115
132H-120-480	REP-E	92-14-075	132I-108-090	NEW-P	92-09-152	132I-120-305	REP-P	92-09-152
132H-120-490	REP-P	92-14-061	132I-108-090	NEW	92-15-115	132I-120-305	REP	92-15-115
132H-120-490	REP-E	92-14-075	132I-108-100	NEW-P	92-09-152	132I-120-310	REP-P	92-09-152
132H-121-010	NEW-P	92-15-065	132I-108-110	NEW	92-15-115	132I-120-310	REP	92-15-115
132H-122-010	NEW-P	92-15-068	132I-108-110	NEW-P	92-09-152	132I-120-320	REP-P	92-09-152
132H-122-020	NEW-P	92-15-068	132I-108-110	NEW	92-15-115	132I-120-320	REP	92-15-115
132H-122-030	NEW-P	92-15-068	132I-108-120	NEW-P	92-09-152	132I-120-325	REP-P	92-09-152
132H-128-010	REP-E	92-07-072	132I-108-120	NEW	92-15-115	132I-120-325	REP	92-15-115
132H-128-010	REP-P	92-09-059	132I-112-010	REP-P	92-09-152	132I-120-335	REP-P	92-09-152
132H-128-010	REP	92-13-095	132I-112-010	REP	92-15-115	132I-120-335	REP	92-15-115
132H-128-020	REP-E	92-07-072	132I-112-020	REP-P	92-09-152	132I-120-345	REP-P	92-09-152
132H-128-020	REP-P	92-09-059	132I-112-020	REP	92-15-115	132I-120-345	REP	92-15-115
132H-128-020	REP	92-13-095	132I-112-030	REP-P	92-09-152	132I-120-400	AMD-P	92-09-152
132H-128-030	REP-E	92-07-072	132I-112-030	REP	92-15-115	132I-120-400	AMD	92-15-115
132H-128-030	REP-P	92-09-059	132I-112-040	REP-P	92-09-152	132I-120-405	REP-P	92-09-152
132H-128-030	REP	92-13-095	132I-112-040	REP	92-15-115	132I-120-405	REP	92-15-115
132H-128-040	REP-E	92-07-072	132I-112-050	REP-P	92-09-152			

Table of WAC Sections Affected

WAC #	WSR #	WAC #	WSR #	WAC #	WSR #			
132I-120-410	AMD-P	92-09-152	132I-128-130	REP	92-15-115	132I-140-140	NEW-P	92-09-152
132I-120-410	AMD	92-15-115	132I-128-140	REP-P	92-09-152	132I-140-140	NEW	92-15-115
132I-120-415	AMD-P	92-09-152	132I-128-140	REP	92-15-115	132I-140-150	NEW-P	92-09-152
132I-120-415	AMD	92-15-115	132I-128-150	REP-P	92-09-152	132I-140-150	NEW	92-15-115
132I-120-420	REP-P	92-09-152	132I-128-150	REP	92-15-115	132I-140-160	NEW-P	92-09-152
132I-120-420	REP	92-15-115	132I-128-160	REP-P	92-09-152	132I-140-160	NEW	92-15-115
132I-120-421	NEW-P	92-09-152	132I-128-160	REP	92-15-115	132I-140-170	NEW-P	92-09-152
132I-120-421	NEW	92-15-115	132I-128-170	REP-P	92-09-152	132I-140-170	NEW	92-15-115
132I-120-424	NEW-P	92-09-152	132I-128-170	REP	92-15-115	132I-160-010	AMD-P	92-09-152
132I-120-424	NEW	92-15-115	132I-128-180	REP-P	92-09-152	132I-160-010	AMD	92-15-115
132I-120-425	REP-P	92-09-152	132I-128-180	REP	92-15-115	132I-160-020	AMD-P	92-09-152
132I-120-425	REP	92-15-115	132I-128-190	REP-P	92-09-152	132I-160-020	AMD	92-15-115
132I-120-426	NEW-P	92-09-152	132I-128-190	REP	92-15-115	132I-160-025	NEW-P	92-09-152
132I-120-426	NEW	92-15-115	132I-128-200	REP-P	92-09-152	132I-160-025	NEW	92-15-115
132I-120-427	NEW-P	92-09-152	132I-128-200	REP	92-15-115	132I-160-030	REP-P	92-09-152
132I-120-427	NEW	92-15-115	132I-128-310	REP-P	92-09-152	132I-160-031	NEW-P	92-09-152
132I-120-428	NEW-P	92-09-152	132I-128-310	REP	92-15-115	132I-160-031	NEW	92-15-115
132I-120-428	NEW	92-15-115	132I-128-320	REP-P	92-09-152	132I-160-032	NEW-P	92-09-152
132I-120-429	NEW-P	92-09-152	132I-128-320	REP	92-15-115	132I-160-032	NEW	92-15-115
132I-120-429	NEW	92-15-115	132I-128-330	REP-P	92-09-152	132I-160-033	NEW-P	92-09-152
132I-120-430	REP-P	92-09-152	132I-128-330	REP	92-15-115	132I-160-033	NEW	92-15-115
132I-120-430	REP	92-15-115	132I-128-340	REP-P	92-09-152	132I-160-035	NEW-P	92-09-152
132I-120-431	NEW-P	92-09-152	132I-128-340	REP	92-15-115	132I-160-035	NEW	92-15-115
132I-120-431	NEW	92-15-115	132I-128-350	REP-P	92-09-152	132I-160-040	REP-P	92-09-152
132I-120-432	NEW-P	92-09-152	132I-128-350	REP	92-15-115	132I-160-045	NEW-P	92-09-152
132I-120-432	NEW	92-15-115	132I-128-360	REP-P	92-09-152	132I-160-045	NEW	92-15-115
132I-120-435	AMD-P	92-09-152	132I-128-360	REP	92-15-115	132I-160-047	NEW-P	92-09-152
132I-120-435	AMD	92-15-115	132I-128-800	REP-P	92-09-152	132I-160-047	NEW	92-15-115
132I-120-440	REP-P	92-09-152	132I-128-800	REP	92-15-115	132I-160-050	REP-P	92-09-152
132I-120-440	REP	92-15-115	132I-128-810	REP-P	92-09-152	132I-160-060	AMD-P	92-09-152
132I-120-441	NEW-P	92-09-152	132I-128-810	REP	92-15-115	132I-160-060	AMD	92-15-115
132I-120-441	NEW	92-15-115	132I-128-820	REP-P	92-09-152	132I-160-065	NEW-P	92-09-152
132I-120-442	NEW-P	92-09-152	132I-128-820	REP	92-15-115	132I-160-065	NEW	92-15-115
132I-120-442	NEW	92-15-115	132I-130-010	NEW-P	92-09-152	132I-160-070	REP-P	92-09-152
132I-120-443	NEW-P	92-09-152	132I-130-010	NEW	92-15-115	132I-160-080	REP-P	92-09-152
132I-120-443	NEW	92-15-115	132I-130-020	NEW-P	92-09-152	132I-160-090	AMD-P	92-09-152
132I-120-444	NEW-P	92-09-152	132I-130-020	NEW	92-15-115	132I-160-090	AMD	92-15-115
132I-120-444	NEW	92-15-115	132I-131-010	NEW-P	92-09-152	132I-160-100	AMD-P	92-09-152
132I-120-450	NEW-P	92-09-152	132I-131-010	NEW	92-15-115	132I-160-100	AMD	92-15-115
132I-120-450	NEW	92-15-115	132I-132-010	NEW-P	92-09-152	132I-160-110	AMD-P	92-09-152
132I-120-510	AMD-P	92-09-152	132I-132-010	NEW	92-15-115	132I-160-110	AMD	92-15-115
132I-120-510	AMD	92-15-115	132I-133-010	NEW-P	92-09-152	132I-160-120	NEW-P	92-09-152
132I-120-530	NEW-P	92-09-152	132I-133-010	NEW	92-15-115	132I-160-120	NEW	92-15-115
132I-120-530	NEW	92-15-115	132I-134-010	NEW-P	92-09-152	132I-168-010	REP-P	92-09-152
132I-122-010	NEW-P	92-09-152	132I-134-010	NEW	92-15-115	132I-168-010	REP	92-15-115
132I-122-010	NEW	92-15-115	132I-136-100	REP-P	92-09-152	132I-168-020	REP-P	92-09-152
132I-122-020	NEW-P	92-09-152	132I-136-100	REP	92-15-115	132I-168-020	REP	92-15-115
132I-122-020	NEW	92-15-115	132I-136-110	REP-P	92-09-152	132I-168-030	REP-P	92-09-152
132I-122-030	NEW-P	92-09-152	132I-136-110	REP	92-15-115	132I-168-030	REP	92-15-115
132I-122-030	NEW	92-15-115	132I-136-120	REP-P	92-09-152	132I-168-040	REP-P	92-09-152
132I-124-010	NEW-P	92-09-152	132I-136-120	REP	92-15-115	132I-168-040	REP	92-15-115
132I-124-010	NEW	92-15-115	132I-136-130	REP-P	92-09-152	132I-168-050	REP-P	92-09-152
132I-128-011	REP-P	92-09-152	132I-136-130	REP	92-15-115	132I-168-050	REP	92-15-115
132I-128-011	REP	92-15-115	132I-136-140	REP-P	92-09-152	132I-168-060	REP-P	92-09-152
132I-128-021	REP-P	92-09-152	132I-136-140	REP	92-15-115	132I-168-060	REP	92-15-115
132I-128-021	REP	92-15-115	132I-136-150	REP-P	92-09-152	132I-168-070	REP-P	92-09-152
132I-128-031	REP-P	92-09-152	132I-136-150	REP	92-15-115	132I-168-070	REP	92-15-115
132I-128-031	REP	92-15-115	132I-136-160	REP-P	92-09-152	132I-168-080	REP-P	92-09-152
132I-128-041	REP-P	92-09-152	132I-136-160	REP	92-15-115	132I-168-080	REP	92-15-115
132I-128-041	REP	92-15-115	132I-136-170	REP-P	92-09-152	132I-168-090	REP-P	92-09-152
132I-128-051	REP-P	92-09-152	132I-136-170	REP	92-15-115	132I-168-090	REP	92-15-115
132I-128-051	REP	92-15-115	132I-140-010	NEW-P	92-09-152	132I-168-100	REP-P	92-09-152
132I-128-061	REP-P	92-09-152	132I-140-010	NEW	92-15-115	132I-168-100	REP	92-15-115
132I-128-061	REP	92-15-115	132I-140-015	NEW-P	92-09-152	132I-168-110	REP-P	92-09-152
132I-128-071	REP-P	92-09-152	132I-140-015	NEW	92-15-115	132I-168-110	REP	92-15-115
132I-128-071	REP	92-15-115	132I-140-016	NEW-P	92-09-152	132I-168A-020	REP-P	92-09-152
132I-128-081	REP-P	92-09-152	132I-140-016	NEW	92-15-115	132I-168A-020	REP	92-15-115
132I-128-081	REP	92-15-115	132I-140-110	NEW-P	92-09-152	132I-168A-030	AMD-P	92-09-152
132I-128-091	REP-P	92-09-152	132I-140-110	NEW	92-15-115	132I-168A-030	AMD	92-15-115
132I-128-091	REP	92-15-115	132I-140-120	NEW-P	92-09-152	132I-168A-090	AMD-P	92-09-152
132I-128-101	REP-P	92-09-152	132I-140-120	NEW	92-15-115	132I-168A-090	AMD	92-15-115
132I-128-101	REP	92-15-115	132I-140-130	NEW-P	92-09-152	132I-168A-100	AMD-P	92-09-152
132I-128-110	REP-P	92-09-152	132I-140-130	NEW	92-15-115	132I-168A-100	AMD	92-15-115
132I-128-110	REP	92-15-115	132I-140-134	NEW-P	92-09-152	132I-276-010	NEW-P	92-09-152
132I-128-120	REP-P	92-09-152	132I-140-134	NEW	92-15-115	132I-276-010	NEW	92-15-115
132I-128-120	REP	92-15-115	132I-140-135	NEW-P	92-09-152	132I-276-015	NEW-P	92-09-152
132I-128-130	REP-P	92-09-152	132I-140-135	NEW	92-15-115	132I-276-015	NEW	92-15-115



Table of WAC Sections Affected

WAC #	WSR #	WAC #	WSR #	WAC #	WSR #			
132K-12-500	REP	92-03-031	132M-115-001	NEW	92-09-007	132Q-04-096	NEW-P	92-10-053
132K-12-510	REP	92-03-031	132M-115-010	REP-P	92-04-061	132Q-04-096	NEW	92-14-038
132K-12-520	REP	92-03-031	132M-115-010	REP	92-09-007	132Q-04-120	AMD-P	92-10-053
132K-12-530	REP	92-03-031	132M-115-020	REP-P	92-04-061	132Q-04-120	AMD	92-14-038
132K-12-540	REP	92-03-031	132M-115-020	REP	92-09-007	132Q-04-130	AMD-P	92-10-053
132K-12-550	REP	92-03-031	132M-115-030	REP-P	92-04-061	132Q-04-130	AMD	92-14-038
132K-12-560	REP	92-03-031	132M-115-030	REP	92-09-007	132Q-04-140	AMD-P	92-10-053
132K-12-570	REP	92-03-031	132M-115-040	REP-P	92-04-061	132Q-04-140	AMD	92-14-038
132K-12-580	REP	92-03-031	132M-115-040	REP	92-09-007	132Q-04-170	AMD-P	92-10-053
132K-12-590	REP	92-03-031	132M-120	AMD-P	92-04-059	132Q-04-170	AMD	92-14-038
132K-12-600	REP	92-03-031	132M-120	AMD	92-09-094	132Q-04-180	AMD-P	92-10-053
132K-12-610	REP	92-03-031	132M-120-010	AMD-P	92-04-059	132Q-04-180	AMD	92-14-038
132K-12-620	REP	92-03-031	132M-120-010	AMD	92-09-094	132Q-04-190	AMD-P	92-10-053
132K-12-630	REP	92-03-031	132M-120-010	AMD-P	92-04-059	132Q-04-190	AMD	92-14-038
132K-12-640	REP	92-03-031	132M-120-020	AMD	92-09-094	132Q-04-200	AMD-P	92-10-053
132K-12-650	REP	92-03-031	132M-120-020	AMD	92-09-094	132Q-04-200	AMD	92-14-038
132K-12-660	REP	92-03-031	132M-120-025	NEW-P	92-04-059	132Q-04-200	AMD	92-10-053
132K-12-670	REP	92-03-031	132M-120-025	NEW	92-09-094	132Q-04-210	AMD-P	92-10-053
132K-12-680	REP	92-03-031	132M-120-030	AMD-P	92-04-059	132Q-04-210	AMD	92-14-038
132K-12-690	REP	92-03-031	132M-120-030	AMD	92-09-094	132Q-04-250	AMD-P	92-10-053
132K-12-700	REP	92-03-031	132M-120-040	AMD-P	92-04-059	132Q-04-250	AMD	92-14-038
132K-12-710	REP	92-03-031	132M-120-040	AMD	92-09-094	132Q-04-260	AMD-P	92-10-053
132K-12-720	REP	92-03-031	132M-120-040	AMD	92-09-094	132Q-04-260	AMD	92-14-038
132K-12-725	REP	92-03-031	132M-120-050	REP-P	92-04-059	132Q-04-280	AMD-P	92-10-053
132K-12-730	REP	92-03-031	132M-120-050	REP	92-09-094	132Q-04-280	AMD	92-14-038
132K-12-740	REP	92-03-031	132M-120-065	NEW-P	92-04-059	132Q-05-050	AMD-P	92-10-052
132K-12-750	REP	92-03-031	132M-120-065	NEW	92-09-094	132Q-05-050	AMD	92-14-037
132K-12-760	REP	92-03-031	132M-120-070	REP-P	92-04-059	132Q-05-060	AMD-P	92-10-052
132K-12-760	REP	92-03-031	132M-120-070	REP	92-09-094	132Q-05-060	AMD	92-14-037
132K-12-770	REP	92-03-031	132M-120-080	REP-P	92-04-059	132Q-05-070	AMD-P	92-10-052
132K-12-780	REP	92-03-031	132M-120-080	REP	92-09-094	132Q-05-070	AMD	92-14-037
132K-12-790	REP	92-03-031	132M-120-095	NEW-P	92-04-059	132Q-05-080	AMD-P	92-10-052
132K-12-800	REP	92-03-031	132M-120-095	NEW	92-09-094	132Q-05-080	AMD	92-14-037
132K-12-810	REP	92-03-031	132M-120-100	NEW-P	92-04-059	132Q-05-090	AMD-P	92-10-052
132K-12-820	REP	92-03-031	132M-120-100	NEW	92-09-094	132Q-05-090	AMD	92-14-037
132K-12-830	REP	92-03-031	132M-120-110	NEW-P	92-04-059	132Q-05-090	AMD	92-10-052
132K-12-840	REP	92-03-031	132M-120-110	NEW	92-09-094	132Q-05-100	AMD-P	92-10-052
132M-108-010	NEW-P	92-04-058	132M-120-120	NEW-P	92-04-059	132Q-05-100	AMD	92-14-037
132M-108-010	NEW	92-09-005	132M-120-120	NEW	92-09-094	132Q-05-120	AMD-P	92-10-052
132M-108-020	NEW-P	92-04-058	132M-120-130	NEW-P	92-04-059	132Q-05-120	AMD	92-14-037
132M-108-020	NEW	92-09-005	132M-120-130	NEW	92-09-094	132Q-06-020	AMD-P	92-10-057
132M-108-030	NEW-P	92-04-058	132M-120-200	NEW-P	92-04-059	132Q-06-020	AMD	92-14-042
132M-108-030	NEW	92-09-005	132M-120-200	NEW	92-09-094	132Q-06-025	AMD-P	92-10-057
132M-108-040	NEW-P	92-04-058	132M-120-210	NEW-P	92-04-059	132Q-06-025	AMD	92-14-042
132M-108-040	NEW	92-09-005	132M-120-210	NEW	92-09-094	132Q-06-030	AMD-P	92-10-057
132M-108-050	NEW-P	92-04-058	132M-120-220	NEW-P	92-04-059	132Q-06-030	AMD	92-14-042
132M-108-050	NEW	92-09-005	132M-120-220	NEW	92-09-094	132Q-06-040	AMD-P	92-10-057
132M-108-060	NEW-P	92-04-058	132M-120-300	NEW-P	92-04-059	132Q-06-040	AMD	92-14-042
132M-108-060	NEW	92-09-005	132M-120-300	NEW	92-09-094	132Q-12-010	AMD-P	92-10-056
132M-108-070	NEW-P	92-04-058	132M-120-310	NEW-P	92-04-059	132Q-12-010	AMD	92-14-041
132M-108-070	NEW	92-09-005	132M-120-310	NEW	92-09-094	132Q-16-003	REP-P	92-10-058
132M-108-080	NEW-P	92-04-058	132M-120-320	NEW-P	92-04-059	132Q-16-003	REP	92-14-043
132M-108-080	NEW	92-09-005	132M-120-320	NEW	92-09-094	132Q-16-006	REP-P	92-10-058
132M-108-080	NEW	92-09-005	132M-120-320	NEW	92-09-094	132Q-16-006	REP	92-14-043
132M-110-130	AMD-P	92-04-057	132M-136-020	AMD-P	92-04-063	132Q-16-009	REP-P	92-10-058
132M-110-130	AMD	92-09-004	132M-136-020	AMD	92-09-009	132Q-16-009	REP	92-14-043
132M-112-010	REP-P	92-04-064	132M-136-060	AMD-P	92-04-063	132Q-16-009	REP	92-10-058
132M-112-010	REP	92-09-092	132M-136-060	AMD	92-09-009	132Q-16-012	REP-P	92-14-043
132M-112-011	REP-P	92-04-064	132M-136-100	NEW-P	92-04-063	132Q-16-012	REP	92-10-058
132M-112-011	REP	92-09-092	132M-136-100	NEW	92-09-009	132Q-16-015	REP-P	92-10-058
132M-113-010	AMD-P	92-04-065	132M-140-010	REP-P	92-04-063	132Q-16-015	REP	92-14-043
132M-113-010	AMD	92-09-093	132M-140-010	REP	92-09-009	132Q-16-018	REP-P	92-10-058
132M-113-015	AMD-P	92-04-065	132M-160-010	AMD-P	92-04-062	132Q-16-018	REP	92-14-043
132M-113-015	AMD	92-09-093	132M-160-010	AMD	92-09-008	132Q-16-021	REP-P	92-10-058
132M-113-020	AMD-P	92-04-065	132M-300-001	NEW-P	92-04-064	132Q-16-021	REP	92-14-043
132M-113-020	AMD	92-09-093	132M-300-001	NEW	92-09-092	132Q-16-024	REP-P	92-10-058
132M-113-025	AMD-P	92-04-065	132M-300-010	NEW-P	92-04-064	132Q-16-024	REP	92-14-043
132M-113-025	AMD	92-09-093	132M-300-010	NEW	92-09-092	132Q-16-027	REP-P	92-10-058
132M-113-030	AMD-P	92-04-065	132M-400-010	NEW-P	92-04-060	132Q-16-027	REP	92-14-043
132M-113-030	AMD	92-09-093	132M-400-010	NEW	92-09-006	132Q-16-030	REP-P	92-10-058
132M-113-035	REP-P	92-04-065	132M-400-020	NEW-P	92-04-060	132Q-16-030	REP	92-14-043
132M-113-035	REP	92-09-093	132M-400-020	NEW	92-09-006	132Q-16-033	REP-P	92-10-058
132M-113-045	REP-P	92-04-065	132M-400-030	NEW-P	92-04-060	132Q-16-033	REP	92-14-043
132M-113-045	REP	92-09-093	132M-400-030	NEW	92-09-006	132Q-16-036	REP-P	92-10-058
132M-113-050	NEW-P	92-04-065	132M-400-040	NEW-P	92-04-060	132Q-16-036	REP	92-14-043
132M-113-050	NEW	92-09-093	132M-400-040	NEW	92-09-006	132Q-16-039	REP-P	92-10-058
132M-113-055	NEW-P	92-04-065	132Q-04-020	AMD-P	92-10-053	132Q-16-039	REP	92-14-043
132M-113-055	NEW	92-09-093	132Q-04-020	AMD	92-14-038	132Q-16-042	REP-P	92-10-058
132M-115-001	NEW-P	92-04-061	132Q-04-095	AMD-P	92-10-053	132Q-16-042	REP	92-14-043
			132Q-04-095	AMD	92-14-038	132Q-16-045	REP-P	92-10-058

### Table of WAC Sections Affected

WAC #		WSR #	WAC #		WSR #	WAC #		WSR #
132Q-16-045	REP	92-14-043	136-01-030	AMD-P	92-08-068	172-108-030	NEW	92-09-100
132Q-16-048	REP-P	92-10-058	136-01-030	AMD	92-13-036	172-108-040	NEW-P	92-04-084
132Q-16-048	REP	92-14-043	136-03-010	NEW-P	92-08-069	172-108-040	NEW	92-09-100
132Q-16-051	REP-P	92-10-058	136-03-010	NEW	92-13-037	172-108-050	NEW-P	92-04-084
132Q-16-051	REP	92-14-043	136-03-020	NEW-P	92-08-069	172-108-050	NEW	92-09-100
132Q-16-054	REP-P	92-10-058	136-03-020	NEW	92-13-037	172-108-060	NEW-P	92-04-084
132Q-16-054	REP	92-14-043	136-03-030	NEW-P	92-08-069	172-108-060	NEW	92-09-100
132Q-16-057	REP-P	92-10-058	136-03-030	NEW	92-13-037	172-108-070	NEW-P	92-04-084
132Q-16-057	REP	92-14-043	136-03-040	NEW-P	92-08-069	172-108-070	NEW	92-09-100
132Q-16-060	REP-P	92-10-058	136-03-040	NEW	92-13-037	172-108-080	NEW-P	92-04-084
132Q-16-060	REP	92-14-043	136-03-050	NEW-P	92-08-069	172-108-080	NEW	92-09-100
132Q-16-063	REP-P	92-10-058	136-03-050	NEW	92-13-037	172-108-090	NEW-P	92-04-084
132Q-16-063	REP	92-14-043	136-03-060	NEW-P	92-08-069	172-108-090	NEW	92-09-100
132Q-20-020	AMD-P	92-10-051	136-03-060	NEW	92-13-037	172-118	AMD-P	92-15-129
132Q-20-020	AMD	92-14-036	136-03-070	NEW-P	92-08-069	172-118-010	AMD-P	92-15-129
132Q-20-040	AMD-P	92-10-051	136-03-070	NEW	92-13-037	172-118-020	AMD-P	92-15-129
132Q-20-040	AMD	92-14-036	136-03-080	NEW-P	92-08-069	172-118-030	AMD-P	92-15-129
132Q-20-060	AMD-P	92-10-051	136-03-080	NEW	92-13-037	172-118-040	AMD-P	92-15-129
132Q-20-060	AMD	92-14-036	136-03-090	NEW-P	92-08-069	172-118-050	AMD-P	92-15-129
132Q-20-090	AMD-P	92-10-051	136-03-090	NEW	92-13-037	172-118-060	REP-P	92-15-129
132Q-20-090	AMD	92-14-036	136-03-100	NEW-P	92-08-069	172-118-070	REP-P	92-15-129
132Q-20-110	AMD-P	92-10-051	136-03-100	NEW	92-13-037	172-118-080	AMD-P	92-15-129
132Q-20-110	AMD	92-14-036	136-03-110	NEW-P	92-08-069	172-118-090	AMD-P	92-15-129
132Q-20-130	AMD-P	92-10-051	136-03-110	NEW	92-13-037	172-122-100	NEW-P	92-15-127
132Q-20-130	AMD	92-14-036	136-130-030	AMD-P	92-08-070	172-122-110	NEW-P	92-15-127
132Q-20-160	AMD-P	92-10-051	136-130-030	AMD	92-13-038	172-122-120	NEW-P	92-15-127
132Q-20-160	AMD	92-14-036	136-130-050	AMD-P	92-08-070	172-122-200	NEW-P	92-15-127
132Q-20-170	AMD-P	92-10-051	136-130-050	AMD	92-13-038	172-122-210	NEW-P	92-15-127
132Q-20-170	AMD	92-14-036	136-130-060	AMD-P	92-08-070	172-122-300	NEW-P	92-15-127
132Q-20-200	AMD-P	92-10-051	136-130-060	AMD	92-13-038	172-122-400	NEW-P	92-15-127
132Q-20-200	AMD	92-14-036	136-130-070	AMD-P	92-08-070	172-122-410	NEW-P	92-15-127
132Q-20-210	AMD-P	92-10-051	136-130-070	AMD	92-13-038	172-124	AMD-P	92-05-056
132Q-20-210	AMD	92-14-036	136-160-050	AMD-P	92-08-071	172-124	AMD	92-09-105
132Q-20-220	AMD-P	92-10-051	136-160-050	AMD	92-13-039	172-124-010	AMD-P	92-05-056
132Q-20-220	AMD	92-14-036	136-160-060	AMD-P	92-08-071	172-124-010	AMD	92-09-105
132Q-20-240	AMD-P	92-10-051	136-160-060	AMD	92-13-039	172-124-020	AMD-P	92-05-056
132Q-20-240	AMD	92-14-036	136-210-020	AMD-P	92-08-072	172-124-020	AMD	92-09-105
132Q-20-250	AMD-P	92-10-051	136-210-020	AMD-W	92-12-005	172-124-100	REP-P	92-05-056
132Q-20-250	AMD	92-14-036	136-210-030	AMD-P	92-08-072	172-124-100	REP	92-09-105
132Q-20-260	AMD-P	92-10-051	136-210-030	AMD-W	92-12-005	172-124-200	REP-P	92-05-056
132Q-20-260	AMD	92-14-036	142-12-026	AMD-P	92-10-031	172-124-200	REP	92-09-105
132Q-108-050	AMD-P	92-10-054	142-12-026	AMD	92-15-080	172-124-210	REP-P	92-05-056
132Q-108-050	AMD	92-14-039	142-40-010	NEW-P	92-10-032	172-124-210	REP	92-09-105
132Q-113-010	AMD-P	92-10-055	142-40-010	NEW	92-14-035	172-124-220	REP-P	92-05-056
132Q-113-010	AMD	92-14-040	142-40-020	NEW-P	92-10-032	172-139-010	NEW-P	92-15-128
132Y-100-008	AMD-P	92-04-067	142-40-020	NEW	92-14-035	172-139-020	NEW-P	92-15-128
132Y-100-008	AMD	92-09-055	142-40-030	NEW-P	92-10-032	172-139-030	NEW-P	92-15-128
132Y-100-010	REP-P	92-04-067	142-40-030	NEW	92-14-035	172-139-040	NEW-P	92-15-128
132Y-100-010	REP	92-09-055	172-04-010	NEW-P	92-04-085	172-144-010	AMD-P	92-05-053
132Y-100-028	AMD-P	92-04-067	172-04-010	NEW	92-09-101	172-144-010	AMD	92-09-102
132Y-100-028	AMD	92-09-055	172-06-010	NEW-P	92-04-083	172-144-020	AMD-P	92-05-053
132Y-100-036	REP-P	92-04-067	172-06-010	NEW	92-09-099	172-144-020	AMD	92-09-102
132Y-100-036	REP	92-09-055	172-65	AMD-P	92-05-054	172-144-030	REP-P	92-05-053
132Y-100-040	REP-P	92-04-067	172-65	AMD	92-09-103	172-144-030	REP	92-09-102
132Y-100-040	REP	92-09-055	172-65-010	AMD-P	92-05-054	172-144-040	AMD-P	92-05-053
132Y-100-044	AMD-P	92-04-067	172-65-010	AMD	92-09-103	172-144-040	AMD	92-09-102
132Y-100-044	AMD	92-09-055	172-65-020	AMD-P	92-05-054	172-144-045	NEW-P	92-05-053
132Y-100-048	REP-P	92-04-067	172-65-020	AMD	92-09-103	172-144-045	NEW	92-09-102
132Y-100-048	REP	92-09-055	172-65-030	AMD-P	92-05-054	172-144-050	REP-P	92-05-053
132Y-100-066	NEW-P	92-04-067	172-65-030	AMD	92-09-103	172-144-050	REP	92-09-102
132Y-100-066	NEW	92-09-055	172-65-040	AMD-P	92-05-054	172-144-050	REP	92-09-102
132Y-100-072	AMD-P	92-04-067	172-65-040	AMD	92-09-103	172-168-020	AMD-P	92-14-056
132Y-100-072	AMD	92-09-055	172-65-050	AMD-P	92-05-054	172-168-060	REP-P	92-14-056
132Y-100-100	AMD-P	92-04-067	172-65-050	AMD	92-09-103	172-168-070	AMD-P	92-14-056
132Y-100-100	AMD	92-09-055	172-65-060	AMD-P	92-05-054	172-168-080	AMD-P	92-14-056
132Y-100-104	AMD-P	92-04-067	172-65-060	AMD	92-09-103	172-168-090	AMD-P	92-14-056
132Y-100-104	AMD	92-09-055	172-65-070	AMD-P	92-05-054	172-168-100	AMD-P	92-14-056
132Y-100-112	AMD-P	92-04-067	172-65-070	AMD	92-09-103	172-168-110	AMD-P	92-14-056
132Y-100-112	AMD	92-09-055	172-65-080	AMD-P	92-05-054	172-168-120	AMD-P	92-14-056
132Y-100-116	AMD-P	92-04-067	172-65-080	AMD	92-09-103	172-168-130	AMD-P	92-14-056
132Y-100-116	AMD	92-09-055	172-65-090	AMD-P	92-05-054	172-325-010	AMD-P	92-05-055
132Y-100-120	AMD-P	92-04-067	172-65-090	AMD	92-09-103	172-325-010	AMD	92-09-104
132Y-100-120	AMD	92-09-055	172-108-010	NEW-P	92-04-084	173-03-030	AMD-E	92-13-049
136-01-010	AMD-P	92-08-068	172-108-010	NEW	92-09-100	173-03-030	AMD-P	92-15-112
136-01-010	AMD	92-13-036	172-108-020	NEW-P	92-04-084	173-03-040	AMD-E	92-13-049
136-01-020	AMD-P	92-08-068	172-108-020	NEW	92-09-100	173-03-040	AMD-P	92-15-112
136-01-020	AMD	92-13-036	172-108-030	NEW-P	92-04-084	173-03-060	AMD-E	92-13-049



Table of WAC Sections Affected

WAC #	WSR #	WAC #	WSR #	WAC #	WSR #			
173-03-060	AMD-P	92-15-112	173-175-240	NEW-P	92-06-091	173-183-310	NEW	92-10-005
173-03-070	AMD-E	92-13-049	173-175-240	NEW	92-12-055	173-183-320	NEW	92-10-005
173-03-070	AMD-P	92-15-112	173-175-250	NEW-P	92-06-091	173-183-330	NEW	92-10-005
173-03-100	AMD-E	92-13-049	173-175-250	NEW	92-12-055	173-183-340	NEW	92-10-005
173-03-100	AMD-P	92-15-112	173-175-260	NEW-P	92-06-091	173-183-350	NEW-W	92-11-038
173-19-130	AMD-P	92-07-091	173-175-260	NEW	92-12-055	173-183-400	NEW	92-10-005
173-19-130	AMD	92-13-081	173-175-270	NEW-P	92-06-091	173-183-410	NEW	92-10-005
173-19-1701	AMD	92-03-132	173-175-270	NEW	92-12-055	173-183-420	NEW	92-10-005
173-19-230	AMD-P	92-04-080	173-175-350	NEW-P	92-06-091	173-183-430	NEW	92-10-005
173-19-230	AMD	92-09-135	173-175-350	NEW	92-12-055	173-183-440	NEW	92-10-005
173-19-2503	AMD-P	92-07-090	173-175-360	NEW-P	92-06-091	173-183-450	NEW	92-10-005
173-19-2503	AMD	92-13-080	173-175-360	NEW	92-12-055	173-183-450	NEW	92-13-083
173-19-2511	AMD-P	92-07-087	173-175-370	NEW-P	92-06-091	173-183-460	NEW	92-10-005
173-19-2511	AMD	92-13-082	173-175-370	NEW	92-12-055	173-183-470	NEW	92-10-005
173-19-2515	AMD-P	92-03-128	173-175-380	NEW-P	92-06-091	173-183-500	NEW	92-10-005
173-19-2515	AMD-C	92-09-131	173-175-380	NEW	92-12-055	173-183-600	NEW	92-10-005
173-19-2515	AMD	92-11-044	173-175-390	NEW-P	92-06-091	173-183-610	NEW	92-10-005
173-19-2521	AMD-P	92-07-088	173-175-390	NEW	92-12-055	173-183-620	NEW	92-10-005
173-19-2521	AMD-C	92-09-128	173-175-400	NEW-P	92-06-091	173-183-700	NEW	92-10-005
173-19-2521	AMD-C	92-13-079	173-175-400	NEW	92-12-055	173-183-710	NEW	92-10-005
173-19-2523	AMD-P	92-09-132	173-175-500	NEW-P	92-06-091	173-183-800	NEW	92-10-005
173-19-2601	AMD	92-04-081	173-175-500	NEW	92-12-055	173-183-810	NEW	92-10-005
173-19-2602	AMD-P	92-03-129	173-175-510	NEW-P	92-06-091	173-183-820	NEW	92-10-005
173-19-2602	AMD-C	92-09-127	173-175-510	NEW	92-12-055	173-183-830	NEW	92-10-005
173-19-2602	AMD-C	92-12-054	173-175-520	NEW-P	92-06-091	173-183-840	NEW	92-10-005
173-19-2602	AMD	92-13-084	173-175-520	NEW	92-12-055	173-183-850	NEW	92-10-005
173-19-3514	AMD-P	92-15-109	173-175-530	NEW	92-12-055	173-183-860	NEW	92-10-005
173-19-360	AMD-P	92-11-042	173-175-600	NEW-P	92-06-091	173-183-865	NEW	92-10-005
173-19-360	AMD-C	92-14-120	173-175-600	NEW	92-12-055	173-183-870	NEW	92-10-005
173-19-360	AMD-P	92-15-110	173-175-610	NEW-P	92-06-091	173-183-880	NEW	92-10-005
173-19-4205	AMD-P	92-03-130	173-175-610	NEW	92-12-055	173-183-890	NEW	92-10-005
173-19-4205	AMD	92-09-134	173-175-620	NEW-P	92-06-091	173-183-900	NEW	92-10-005
173-19-430	AMD-P	92-07-089	173-175-620	NEW	92-12-055	173-183-910	NEW	92-10-005
173-19-430	AMD-C	92-13-078	173-175-630	NEW-P	92-06-091	173-183-920	NEW	92-10-005
173-19-450	AMD-P	92-15-108	173-175-630	NEW	92-12-055	173-201-010	REP-P	92-11-041
173-175-010	NEW-P	92-06-091	173-180D-010	NEW-P	92-06-087	173-201-025	REP-P	92-11-041
173-175-010	NEW	92-12-055	173-180D-010	NEW	92-15-035	173-201-035	REP-P	92-11-041
173-175-020	NEW-P	92-06-091	173-180D-020	NEW-P	92-06-087	173-201-045	REP-P	92-11-041
173-175-020	NEW	92-12-055	173-180D-020	NEW	92-15-035	173-201-047	REP-P	92-11-041
173-175-030	NEW-P	92-06-091	173-180D-030	NEW-P	92-06-087	173-201-070	REP-P	92-11-041
173-175-030	NEW	92-12-055	173-180D-030	NEW	92-15-035	173-201-080	REP-P	92-11-041
173-175-040	NEW-P	92-06-091	173-180D-040	NEW-P	92-06-087	173-201-085	REP-P	92-11-041
173-175-040	NEW	92-12-055	173-180D-040	NEW	92-15-035	173-201-090	REP-P	92-11-041
173-175-050	NEW-P	92-06-091	173-180D-050	NEW-P	92-06-087	173-201-100	REP-P	92-11-041
173-175-050	NEW	92-12-055	173-180D-050	NEW	92-15-035	173-201-110	REP-P	92-11-041
173-175-060	NEW-P	92-06-091	173-180D-055	NEW-P	92-06-087	173-201-120	REP-P	92-11-041
173-175-060	NEW	92-12-055	173-180D-055	NEW	92-15-035	173-201A-010	NEW-P	92-11-041
173-175-070	NEW-P	92-06-091	173-180D-060	NEW-P	92-06-087	173-201A-020	NEW-P	92-11-041
173-175-070	NEW	92-12-055	173-180D-060	NEW	92-15-035	173-201A-030	NEW-P	92-11-041
173-175-100	NEW-P	92-06-091	173-180D-065	NEW-P	92-06-087	173-201A-040	NEW-P	92-11-041
173-175-100	NEW	92-12-055	173-180D-065	NEW	92-15-035	173-201A-050	NEW-P	92-11-041
173-175-110	NEW-P	92-06-091	173-180D-070	NEW-P	92-06-087	173-201A-060	NEW-P	92-11-041
173-175-110	NEW	92-12-055	173-180D-070	NEW	92-15-035	173-201A-070	NEW-P	92-11-041
173-175-120	NEW-P	92-06-091	173-180D-075	NEW-P	92-06-087	173-201A-080	NEW-P	92-11-041
173-175-120	NEW	92-12-055	173-180D-075	NEW	92-15-035	173-201A-100	NEW-P	92-11-041
173-175-130	NEW-P	92-06-091	173-180D-080	NEW-P	92-06-087	173-201A-110	NEW-P	92-11-041
173-175-130	NEW	92-12-055	173-180D-080	NEW	92-15-035	173-201A-120	NEW-P	92-11-041
173-175-140	NEW-P	92-06-091	173-180D-085	NEW-P	92-06-087	173-201A-130	NEW-P	92-11-041
173-175-140	NEW	92-12-055	173-180D-085	NEW	92-15-035	173-201A-140	NEW-P	92-11-041
173-175-150	NEW-P	92-06-091	173-180D-090	NEW-P	92-06-087	173-201A-150	NEW-P	92-11-041
173-175-150	NEW	92-12-055	173-180D-090	NEW	92-15-035	173-201A-160	NEW-P	92-11-041
173-175-160	NEW-P	92-06-091	173-180D-098	NEW-P	92-06-087	173-201A-170	NEW-P	92-11-041
173-175-160	NEW	92-12-055	173-180D-098	NEW	92-15-035	173-201A-180	NEW-P	92-11-041
173-175-170	NEW-P	92-06-091	173-183	NEW-C	92-09-034	173-202-020	AMD-E	92-05-084
173-175-170	NEW	92-12-055	173-183-010	NEW	92-10-005	173-202-020	AMD-P	92-07-085
173-175-180	NEW-P	92-06-091	173-183-020	NEW	92-10-005	173-202-020	AMD-S	92-11-068
173-175-180	NEW	92-12-055	173-183-030	NEW	92-10-005	173-202-020	AMD	92-14-098
173-175-190	NEW-P	92-06-091	173-183-100	NEW	92-10-005	173-224-015	AMD	92-03-131
173-175-190	NEW	92-12-055	173-183-200	NEW	92-10-005	173-224-020	AMD	92-03-131
173-175-200	NEW-P	92-06-091	173-183-210	NEW	92-10-005	173-224-030	AMD	92-03-131
173-175-200	NEW	92-12-055	173-183-220	NEW	92-10-005	173-224-040	AMD	92-03-131
173-175-210	NEW-P	92-06-091	173-183-230	NEW	92-10-005	173-224-050	AMD	92-03-131
173-175-210	NEW	92-12-055	173-183-240	NEW	92-10-005	173-224-090	AMD	92-03-131
173-175-220	NEW-P	92-06-091	173-183-250	NEW	92-10-005	173-224-100	AMD	92-03-131
173-175-220	NEW	92-12-055	173-183-260	NEW	92-10-005	173-224-120	AMD	92-03-131
173-175-230	NEW-P	92-06-091	173-183-270	NEW	92-10-005	173-303-145	AMD-P	92-03-127
173-175-230	NEW	92-12-055	173-183-300	NEW	92-10-005	173-303-145	AMD-C	92-11-040



Table of WAC Sections Affected

WAC #	WSR #	WAC #	WSR #	WAC #	WSR #			
173-303-145	AMD	92-15-036	173-492-040	NEW-S	92-11-043	180-27-058	AMD-E	92-13-047
173-303-506	NEW-E	92-11-045	173-492-050	NEW-P	92-06-088	180-27-058	AMD-P	92-13-059
173-305-060	REP-P	92-05-083	173-492-050	NEW-S	92-11-043	180-27-500	NEW-E	92-13-047
173-305-060	REP	92-10-043	173-492-060	NEW-P	92-06-088	180-27-500	NEW-P	92-13-059
173-305-070	REP-P	92-05-083	173-492-060	NEW-S	92-11-043	180-27-505	NEW-E	92-13-047
173-305-070	REP	92-10-043	173-492-070	NEW-P	92-06-088	180-27-505	NEW-P	92-13-059
173-305-080	REP-P	92-05-083	173-492-070	NEW-S	92-11-043	180-27-510	NEW-E	92-13-047
173-305-080	REP	92-10-043	173-492-080	NEW-P	92-06-088	180-27-510	NEW-P	92-13-059
173-305-090	REP-P	92-05-083	173-492-080	NEW-S	92-11-043	180-27-515	NEW-E	92-13-047
173-305-090	REP	92-10-043	173-492-090	NEW-P	92-06-088	180-27-515	NEW-P	92-13-059
173-322-010	AMD-E	92-14-072	173-492-090	NEW-S	92-11-043	180-27-525	NEW-E	92-13-047
173-322-020	AMD-E	92-14-072	173-492-100	NEW-P	92-06-088	180-27-525	NEW-P	92-13-059
173-322-050	AMD-E	92-14-072	173-492-100	NEW-S	92-11-043	180-27-530	NEW-E	92-13-047
173-322-060	AMD-E	92-14-072	173-563-015	NEW-E	92-07-055	180-27-530	NEW-P	92-13-059
173-322-070	AMD-E	92-14-072	173-563-015	NEW-P	92-14-010	180-27-535	NEW-E	92-13-047
173-322-080	AMD-E	92-14-072	173-563-015	NEW-E	92-14-012	180-27-535	NEW-P	92-13-059
173-322-090	AMD-E	92-14-072	173-564-010	NEW-E	92-07-054	180-29-085	AMD-E	92-13-047
173-322-100	AMD-E	92-14-072	173-564-010	NEW-P	92-14-009	180-29-085	AMD-P	92-13-059
173-322-105	NEW-E	92-14-072	173-564-010	NEW-E	92-14-011	180-51-085	AMD-P	92-05-067
173-422-010	AMD-P	92-09-133	173-564-020	NEW-E	92-07-054	180-51-085	AMD	92-08-078
173-422-020	AMD-P	92-09-133	173-564-020	NEW-P	92-14-009	180-53-065	REP-P	92-13-075
173-422-030	AMD-P	92-09-133	173-564-020	NEW-E	92-14-011	180-53-070	NEW-P	92-13-075
173-422-035	AMD-P	92-09-133	173-564-030	NEW-E	92-07-054	180-75-016	NEW	92-04-044
173-422-040	AMD-P	92-09-133	173-564-030	NEW-P	92-14-009	180-75-055	AMD	92-04-044
173-422-050	AMD-P	92-09-133	173-564-030	NEW-E	92-14-011	180-75-065	AMD	92-04-044
173-422-060	AMD-P	92-09-133	173-564-040	NEW-E	92-07-054	180-75-080	REP	92-04-044
173-422-065	NEW-P	92-09-133	173-564-040	NEW-P	92-14-009	180-75-085	AMD	92-04-044
173-422-070	AMD-P	92-09-133	173-564-040	NEW-E	92-14-011	180-75-085	AMD-E	92-13-021
173-422-075	NEW-P	92-09-133	178-01-010	NEW-C	92-03-055	180-75-085	AMD-E	92-15-038
173-422-080	REP-P	92-09-133	178-01-010	NEW-E	92-03-056	180-75-085	AMD-P	92-15-098
173-422-090	AMD-P	92-09-133	178-01-010	NEW	92-09-002	180-75-087	AMD	92-04-044
173-422-095	NEW-P	92-09-133	180-16-200	AMD	92-05-047	180-75-089	NEW	92-04-044
173-422-100	AMD-P	92-09-133	180-16-200	AMD-P	92-13-075	180-75-090	AMD	92-04-044
173-422-110	REP-P	92-09-133	180-16-205	AMD	92-05-047	180-75-110	NEW	92-04-044
173-422-120	AMD-P	92-09-133	180-16-205	AMD-P	92-13-075	180-77-040	AMD	92-05-039
173-422-130	AMD-P	92-09-133	180-16-222	AMD	92-04-044	180-77-045	AMD	92-05-039
173-422-140	AMD-P	92-09-133	180-16-223	AMD	92-04-044	180-77-050	AMD	92-05-039
173-422-150	REP-P	92-09-133	180-20-005	NEW-P	92-13-098	180-77-065	AMD	92-05-039
173-422-160	AMD-P	92-09-133	180-20-030	NEW-P	92-13-098	180-77-100	NEW	92-05-039
173-422-170	AMD-P	92-09-133	180-20-031	NEW-P	92-13-098	180-77-105	NEW	92-05-039
173-422-180	REP-P	92-09-133	180-20-034	NEW-P	92-13-098	180-77-110	NEW	92-05-039
173-425-010	AMD-P	92-12-026	180-20-035	NEW-P	92-13-098	180-78-165	AMD	92-06-027
173-425-020	AMD-P	92-12-026	180-20-036	NEW-P	92-13-098	180-78-200	NEW-W	92-09-108
173-425-030	AMD-P	92-12-026	180-20-040	NEW-P	92-13-098	180-79-045	AMD-E	92-13-021
173-425-036	REP-P	92-12-026	180-20-045	NEW-P	92-13-098	180-79-045	AMD-E	92-15-038
173-425-040	NEW-P	92-12-026	180-20-050	NEW-P	92-13-098	180-79-045	AMD-P	92-15-098
173-425-045	REP-P	92-12-026	180-20-055	NEW-P	92-13-098	180-79-047	AMD	92-04-044
173-425-050	NEW-P	92-12-026	180-20-060	NEW-P	92-13-098	180-79-049	AMD	92-04-044
173-425-055	REP-P	92-12-026	180-20-065	NEW-P	92-13-098	180-79-060	AMD-E	92-13-021
173-425-060	NEW-P	92-12-026	180-20-070	NEW-P	92-13-098	180-79-060	AMD-E	92-15-038
173-425-065	REP-P	92-12-026	180-20-075	NEW-P	92-13-098	180-79-060	AMD-P	92-15-098
173-425-070	NEW-P	92-12-026	180-20-080	NEW-P	92-13-098	180-79-065	AMD-E	92-13-021
173-425-075	REP-P	92-12-026	180-20-090	NEW-P	92-13-098	180-79-065	AMD-E	92-15-038
173-425-080	NEW-P	92-12-026	180-20-095	NEW-P	92-13-098	180-79-065	AMD-P	92-15-098
173-425-085	REP-P	92-12-026	180-20-101	NEW-P	92-13-098	180-79-075	AMD	92-04-044
173-425-090	NEW-P	92-12-026	180-20-111	NEW-P	92-13-098	180-79-080	AMD	92-04-044
173-425-095	REP-P	92-12-026	180-20-115	NEW-P	92-13-098	180-79-085	AMD-E	92-13-021
173-425-100	AMD-P	92-12-026	180-20-120	NEW-P	92-13-098	180-79-086	AMD	92-04-044
173-425-110	NEW-P	92-12-026	180-20-125	NEW-P	92-13-098	180-79-115	AMD	92-04-044
173-425-115	REP-P	92-12-026	180-20-130	NEW-P	92-13-098	180-79-115	AMD-E	92-13-021
173-425-120	REP-P	92-12-026	180-20-135	NEW-P	92-13-098	180-79-115	AMD-E	92-15-038
173-425-130	REP-P	92-12-026	180-20-140	NEW-P	92-13-098	180-79-115	AMD-P	92-15-098
173-425-140	REP-P	92-12-026	180-20-145	NEW-P	92-13-098	180-79-117	AMD-E	92-13-021
173-433-100	AMD-P	92-09-035	180-20-150	NEW-P	92-13-098	180-79-117	AMD-E	92-15-038
173-433-100	AMD-C	92-15-111	180-20-155	NEW-P	92-13-098	180-79-117	AMD-P	92-15-098
173-433-110	AMD-P	92-09-035	180-20-160	NEW-P	92-13-098	180-79-120	AMD	92-04-044
173-433-110	AMD-C	92-15-111	180-25-030	AMD-E	92-13-047	180-79-122	AMD-E	92-13-021
173-433-170	AMD-P	92-09-035	180-25-030	AMD-P	92-13-059	180-79-122	AMD-E	92-15-038
173-433-170	AMD-C	92-15-111	180-25-031	NEW	92-04-043	180-79-122	AMD-P	92-15-098
173-433-170	AMD-E	92-10-022	180-25-032	NEW-E	92-13-047	180-79-123	NEW	92-04-044
173-492-010	NEW-P	92-06-088	180-25-032	NEW-P	92-13-059	180-79-123	AMD-E	92-13-021
173-492-010	NEW-S	92-11-043	180-27-016	NEW-E	92-13-047	180-79-123	AMD-E	92-15-038
173-492-020	NEW-P	92-06-088	180-27-016	NEW-P	92-13-059	180-79-123	AMD-P	92-15-098
173-492-020	NEW-S	92-11-043	180-27-052	NEW-E	92-13-047	180-79-127	AMD-E	92-13-021
173-492-030	NEW-P	92-06-088	180-27-052	NEW-P	92-13-059	180-79-127	AMD-E	92-15-038
173-492-030	NEW-S	92-11-043	180-27-056	AMD-E	92-13-047	180-79-127	AMD-P	92-15-098
173-492-040	NEW-P	92-06-088	180-27-056	AMD-P	92-13-059	180-79-129	REP	92-04-044

Table of WAC Sections Affected

WAC #	WSR #	WAC #	WSR #	WAC #	WSR #			
180-79-131	AMD	92-04-044	220-16-046	NEW	92-15-105	220-52-05100L	NEW-E	92-11-008
180-79-136	AMD	92-04-044	220-20-020	AMD-P	92-10-081	220-52-05100M	NEW-E	92-13-040
180-79-230	AMD	92-04-044	220-20-021	AMD-P	92-10-081	220-52-07300H	NEW-E	92-06-054
180-79-241	AMD-P	92-08-077	220-24-02000L	NEW-E	92-09-130	220-56-10500A	NEW-E	92-08-031
180-79-241	AMD	92-15-037	220-24-02000L	REP-E	92-15-076	220-56-116	AMD-P	92-03-151
180-79-310	REP	92-04-044	220-24-02000M	NEW-E	92-15-076	220-56-116	AMD	92-11-012
180-79-311	NEW	92-04-044	220-32-05100J	REP-E	92-04-051	220-56-145	AMD-P	92-03-151
180-79-333	NEW	92-04-044	220-32-05100K	NEW-E	92-04-051	220-56-156	AMD-P	92-03-151
180-79-379	NEW	92-04-044	220-32-05100K	REP-E	92-07-007	220-56-156	AMD	92-11-012
180-85-045	AMD	92-04-044	220-32-05100L	NEW-E	92-07-007	220-56-15600E	NEW-E	92-09-083
180-85-077	NEW	92-04-044	220-32-05500A	NEW-E	92-09-047	220-56-160	AMD-P	92-03-151
180-85-115	AMD	92-04-044	220-32-05500A	REP-E	92-09-106	220-56-19000S	NEW-E	92-10-017
180-86-150	AMD-P	92-08-077	220-32-05500B	NEW-E	92-09-106	220-56-19000S	REP-E	92-12-013
180-86-150	AMD	92-15-037	220-32-05700I	NEW-E	92-03-022	220-56-19000T	NEW-E	92-12-013
180-86-155	AMD-P	92-08-077	220-32-05700I	REP-E	92-05-004	220-56-19000U	NEW-E	92-13-071
180-86-155	AMD	92-15-037	220-32-05700J	NEW-E	92-04-051	220-56-19000U	REP-E	92-15-086
180-110-035	AMD-P	92-13-058	220-32-05700J	REP-E	92-07-007	220-56-19000V	NEW-E	92-14-046
182-12-111	AMD	92-03-040	220-32-05700K	NEW-E	92-08-090	220-56-19000V	REP-E	92-15-106
182-12-115	AMD-P	92-04-001	220-32-05700K	REP-E	92-14-099	220-56-19000W	NEW-E	92-15-086
182-12-115	AMD-C	92-07-046	220-32-05700L	NEW-E	92-14-099	220-56-19000X	NEW-E	92-15-106
182-12-115	AMD	92-08-003	220-33-01000D	REP-E	92-05-004	220-56-195	AMD-P	92-03-151
192-12-017	REP-P	92-07-104	220-33-01000E	NEW-E	92-05-004	220-56-195	AMD	92-11-012
192-12-017	REP	92-14-047	220-33-03000D	NEW-E	92-11-066	220-56-205	AMD-P	92-03-151
192-12-019	REP-P	92-07-104	220-40-027	AMD-P	92-10-081	220-56-205	AMD	92-11-012
192-12-019	REP	92-14-047	220-44-030	AMD-P	92-03-150	220-56-235	AMD-P	92-03-151
192-12-072	AMD-P	92-07-104	220-44-030	AMD	92-07-008	220-56-235	AMD	92-11-012
192-12-072	AMD	92-14-047	220-44-04000B	NEW-E	92-10-064	220-56-23500G	NEW-E	92-09-083
192-12-300	AMD-P	92-03-145	220-44-050	AMD-P	92-03-150	220-56-240	AMD-P	92-03-151
192-12-305	AMD-P	92-03-145	220-44-050	AMD	92-07-008	220-56-240	AMD	92-11-012
192-12-310	AMD-P	92-03-145	220-44-05000R	REP-E	92-03-030	220-56-24000G	NEW-E	92-09-083
192-12-320	AMD-P	92-03-145	220-44-05000S	NEW-E	92-03-030	220-56-24500K	NEW-E	92-10-039
192-12-370	NEW-P	92-03-145	220-44-05000S	REP-E	92-08-007	220-56-24500K	REP-E	92-12-002
192-12-400	NEW-P	92-07-104	220-44-05000T	NEW-E	92-08-007	220-56-24500L	NEW-E	92-12-002
192-12-400	NEW	92-14-047	220-44-05000T	REP-E	92-09-084	220-56-250	AMD-P	92-03-151
192-12-405	NEW-P	92-07-104	220-44-05000U	NEW-E	92-09-084	220-56-250	AMD	92-11-012
192-12-405	NEW	92-14-047	220-44-05000U	REP-E	92-11-021	220-56-25000E	NEW-E	92-09-083
192-32-120	NEW	92-05-051	220-44-05000V	NEW-E	92-11-021	220-56-25500L	NEW-E	92-10-039
192-32-125	NEW	92-05-051	220-44-05000V	REP-E	92-12-018	220-56-25500L	REP-E	92-12-002
196-24-050	AMD-P	92-04-008	220-44-05000W	NEW-E	92-12-018	220-56-25500M	NEW-E	92-12-002
196-24-050	AMD	92-09-089	220-44-09000A	NEW-E	92-11-004	220-56-25500M	REP-E	92-15-010
196-24-105	AMD-P	92-12-053	220-47	AMD-C	92-11-083	220-56-25500N	NEW-E	92-15-010
196-24-105	AMD	92-15-139	220-47	AMD-S	92-11-083	220-56-25500N	REP-E	92-15-040
204-24-030	AMD	92-05-016	220-47-301	AMD-P	92-09-137	220-56-25500P	NEW-E	92-15-040
204-24-040	AMD	92-05-016	220-47-302	AMD-P	92-09-137	220-56-28000A	NEW-E	92-07-015
204-24-050	AMD	92-05-016	220-47-302	AMD	92-15-105	220-56-282	AMD-P	92-03-151
204-24-070	AMD	92-05-016	220-47-304	AMD-P	92-09-137	220-56-285	AMD-P	92-03-151
204-32	PREP	92-13-012A	220-47-304	AMD	92-15-105	220-56-285	AMD	92-11-012
204-38-030	AMD-P	92-05-015	220-47-307	AMD-P	92-09-137	220-56-28500F	NEW-E	92-09-083
204-38-030	AMD	92-11-032	220-47-307	AMD	92-15-105	220-56-310	AMD-P	92-03-151
204-38-040	AMD-P	92-05-015	220-47-311	AMD-P	92-09-137	220-56-310	AMD	92-11-012
204-38-040	AMD	92-11-032	220-47-311	AMD	92-15-105	220-56-31000K	NEW-E	92-09-083
204-39	PREP	92-13-012A	220-47-319	AMD-P	92-09-137	220-56-315	AMD-P	92-03-151
204-62	PREP	92-13-012A	220-47-319	AMD	92-15-105	220-56-315	AMD	92-11-012
204-70	PREP	92-13-012A	220-47-401	AMD-P	92-09-137	220-56-31500A	NEW-E	92-09-083
204-74A-060	AMD	92-09-050	220-47-401	AMD	92-15-105	220-56-320	AMD-P	92-03-151
212-80-010	AMD-P	92-14-073	220-47-411	AMD-P	92-09-137	220-56-320	AMD	92-11-012
212-80-010	AMD-E	92-14-074	220-47-411	AMD	92-09-105	220-56-32000C	NEW-E	92-09-083
212-80-015	AMD-P	92-14-073	220-47-412	AMD-P	92-09-137	220-56-32500U	NEW-E	92-10-020
212-80-015	AMD-E	92-14-074	220-47-412	AMD	92-15-105	220-56-32500U	REP-E	92-11-065
212-80-030	AMD-P	92-14-073	220-47-500	AMD-P	92-09-137	220-56-32500V	NEW-E	92-11-065
212-80-030	AMD-E	92-14-074	220-47-500	AMD	92-15-105	220-56-335	AMD-P	92-03-151
212-80-035	AMD-P	92-14-073	220-48-005	AMD-P	92-06-092	220-56-335	AMD	92-11-012
212-80-035	AMD-E	92-14-074	220-48-005	AMD-C	92-08-079	220-56-33500G	NEW-E	92-09-083
212-80-055	AMD-P	92-14-073	220-48-005	AMD	92-11-011	220-56-350	AMD-P	92-03-151
212-80-055	AMD-E	92-14-074	220-48-00500A	NEW-E	92-09-073	220-56-350	AMD	92-11-012
212-80-065	AMD-P	92-14-073	220-48-011	AMD-P	92-06-092	220-56-35000P	NEW-E	92-09-083
212-80-065	AMD-E	92-14-074	220-48-011	AMD-C	92-08-079	220-56-360	AMD-P	92-03-151
212-80-115	AMD-P	92-14-073	220-48-042	AMD-P	92-06-092	220-56-360	AMD	92-11-012
212-80-115	AMD-E	92-14-074	220-48-042	AMD-C	92-08-079	220-56-380	AMD-P	92-03-151
212-80-125	NEW-P	92-14-073	220-48-042	AMD	92-11-011	220-56-380	AMD	92-11-012
212-80-125	NEW-E	92-14-074	220-48-052	AMD-P	92-06-092	220-56-38000J	NEW-E	92-09-083
220-16	AMD-C	92-11-083	220-48-052	AMD-C	92-08-079	220-56-400	AMD-P	92-03-151
220-16	AMD-S	92-11-083	220-48-052	AMD	92-11-011	220-56-400	AMD	92-11-012
220-16-01500A	NEW-E	92-13-040	220-49-02000D	NEW-E	92-08-022	220-56-40000B	NEW-E	92-09-083
220-16-040	AMD-P	92-09-137	220-52-05100J	NEW-E	92-10-002	220-57-160	AMD-P	92-03-151
220-16-040	AMD	92-15-105	220-52-05100K	NEW-E	92-10-020	220-57-160	AMD	92-11-012
220-16-046	NEW-P	92-09-137	220-52-05100K	REP-E	92-11-065	220-57-16000L	NEW-E	92-04-050

Table of WAC Sections Affected

WAC #	WSR #	WAC #	WSR #	WAC #	WSR #			
220-57-16000M	NEW-E	92-08-059	220-110-120	AMD-W	92-15-095	222-16-050	AMD-S	92-11-069
220-57-16000N	NEW-E	92-09-083	220-110-130	AMD-P	92-11-082	222-16-050	AMD-E	92-12-038
220-57-175	AMD-P	92-03-151	220-110-130	AMD-W	92-15-095	222-16-050	AMD	92-15-011
220-57-175	AMD	92-11-012	220-110-140	AMD-P	92-11-082	222-16-070	NEW-E	92-06-004
220-57-17500W	NEW-E	92-09-083	220-110-140	AMD-W	92-15-095	222-16-070	NEW-P	92-07-093
220-57-195	AMD-W	92-04-011	220-110-150	AMD-P	92-11-082	222-16-070	NEW-S	92-11-069
220-57-205	AMD-P	92-03-151	220-110-150	AMD-W	92-15-095	222-16-070	NEW-E	92-12-038
220-57-205	AMD-W	92-04-011	220-110-160	AMD-P	92-11-082	222-16-070	NEW	92-15-011
220-57-205	AMD	92-11-012	220-110-160	AMD-W	92-15-095	222-16-080	NEW-P	92-07-093
220-57-210	AMD-P	92-03-151	220-110-170	AMD-P	92-11-082	222-16-080	NEW-S	92-11-069
220-57-210	AMD-W	92-04-011	220-110-170	AMD-W	92-15-095	222-16-080	NEW	92-15-011
220-57-210	AMD	92-11-012	220-110-180	AMD-P	92-11-082	222-22-010	NEW-P	92-07-093
220-57-255	AMD-P	92-03-151	220-110-180	AMD-W	92-15-095	222-22-010	NEW-S	92-11-069
220-57-255	AMD	92-11-012	220-110-190	AMD-P	92-11-082	222-22-010	NEW	92-15-011
220-57-265	AMD-W	92-04-011	220-110-190	AMD-W	92-15-095	222-22-020	NEW-P	92-07-093
220-57-29000M	NEW-E	92-11-020	220-110-200	AMD-P	92-11-082	222-22-020	NEW-S	92-11-069
220-57-31500V	NEW-E	92-08-031	220-110-200	AMD-W	92-15-095	222-22-020	NEW	92-15-011
220-57-385	AMD-P	92-03-151	220-110-210	AMD-P	92-11-082	222-22-030	NEW-P	92-07-093
220-57-385	AMD	92-11-012	220-110-210	AMD-W	92-15-095	222-22-030	NEW-S	92-11-069
220-57-38500T	NEW-E	92-07-035	220-110-220	AMD-P	92-11-082	222-22-030	NEW	92-15-011
220-57-405	AMD-P	92-03-151	220-110-220	AMD-W	92-15-095	222-22-040	NEW-P	92-07-093
220-57-405	AMD	92-11-012	220-110-223	NEW-P	92-11-082	222-22-040	NEW-S	92-11-069
220-57-425	AMD-P	92-03-151	220-110-223	NEW-W	92-15-095	222-22-040	NEW	92-15-011
220-57-425	AMD	92-11-012	220-110-224	NEW-P	92-11-082	222-22-050	NEW-P	92-07-093
220-57-430	AMD-P	92-03-151	220-110-224	NEW-W	92-15-095	222-22-050	NEW-S	92-11-069
220-57-430	AMD-W	92-04-011	220-110-225	NEW-P	92-11-082	222-22-050	NEW	92-15-011
220-57-430	AMD	92-11-012	220-110-225	NEW-W	92-15-095	222-22-060	NEW-P	92-07-093
220-57-435	AMD-P	92-03-151	220-110-250	AMD-P	92-11-082	222-22-060	NEW-S	92-11-069
220-57-435	AMD	92-11-012	220-110-250	AMD-W	92-15-095	222-22-060	NEW	92-15-011
220-57-43500G	NEW-E	92-15-052	220-110-260	REP-P	92-11-082	222-22-070	NEW-P	92-07-093
220-57-450	AMD-P	92-03-151	220-110-260	REP-W	92-15-095	222-22-070	NEW-S	92-11-069
220-57-450	AMD	92-11-012	220-110-270	AMD-P	92-11-082	222-22-070	NEW	92-15-011
220-57-455	AMD-P	92-03-151	220-110-270	AMD-W	92-15-095	222-22-080	NEW-P	92-07-093
220-57-455	AMD	92-11-012	220-110-280	AMD-P	92-11-082	222-22-080	NEW-S	92-11-069
220-57-460	AMD-P	92-03-151	220-110-280	AMD-W	92-15-095	222-22-080	NEW	92-15-011
220-57-460	AMD	92-11-012	220-110-285	NEW-P	92-11-082	222-22-090	NEW-P	92-07-093
220-57-46000Y	NEW-E	92-07-035	220-110-285	NEW-W	92-15-095	222-22-090	NEW-S	92-11-069
220-57-465	AMD-P	92-03-151	220-110-290	AMD-P	92-11-082	222-22-090	NEW	92-15-011
220-57-465	AMD	92-11-012	220-110-290	AMD-W	92-15-095	222-22-100	NEW-P	92-07-093
220-57-470	AMD-W	92-04-011	220-110-300	AMD-P	92-11-082	222-22-100	NEW-S	92-11-069
220-57-490	AMD-P	92-03-151	220-110-300	AMD-W	92-15-095	222-22-100	NEW	92-15-011
220-57-490	AMD-W	92-04-011	220-110-320	AMD-P	92-11-082	222-24-010	AMD-P	92-07-093
220-57-490	AMD	92-11-012	220-110-320	AMD-W	92-15-095	222-24-010	AMD-S	92-11-069
220-57-50500T	NEW-E	92-08-031	220-110-330	AMD-P	92-11-082	222-24-010	AMD	92-15-011
220-57-51500H	NEW-E	92-08-031	220-110-330	AMD-W	92-15-095	222-24-020	AMD-P	92-07-093
220-57A-180	AMD-P	92-03-151	220-110-340	AMD-P	92-11-082	222-24-020	AMD-S	92-11-069
220-57A-180	AMD	92-11-012	220-110-340	AMD-W	92-15-095	222-24-020	AMD	92-15-011
220-69-25000A	NEW-E	92-11-004	220-110-350	AMD-P	92-11-082	222-24-025	AMD-P	92-07-093
220-88-010	NEW-P	92-09-129	220-110-350	AMD-W	92-15-095	222-24-025	AMD-S	92-11-069
220-88-020	NEW-P	92-09-129	220-110-360	NEW-P	92-11-082	222-24-025	AMD	92-15-011
220-88-030	NEW-P	92-09-129	220-110-360	NEW-W	92-15-095	222-24-030	AMD-P	92-07-093
220-88-040	NEW-P	92-09-129	222-12-040	AMD-S	92-11-069	222-24-030	AMD-S	92-11-069
220-88-050	NEW-P	92-09-129	222-12-040	AMD	92-15-011	222-24-030	AMD	92-15-011
220-110	AMD-C	92-14-045	222-12-046	NEW-P	92-07-093	222-24-035	AMD-P	92-07-093
220-110-010	AMD-P	92-11-082	222-12-046	NEW-S	92-11-069	222-24-035	AMD-S	92-11-069
220-110-010	AMD-W	92-15-095	222-12-046	NEW	92-15-011	222-24-035	AMD	92-15-011
220-110-020	AMD-P	92-11-082	222-12-090	AMD-P	92-07-093	222-24-040	AMD-P	92-07-093
220-110-020	AMD-W	92-15-095	222-12-090	AMD-S	92-11-069	222-24-040	AMD-S	92-11-069
220-110-030	AMD-P	92-11-082	222-12-090	AMD	92-15-113	222-24-040	AMD	92-15-011
220-110-030	AMD-W	92-15-095	222-16-010	AMD	92-03-028	222-24-050	AMD-P	92-07-093
220-110-035	NEW-P	92-11-082	222-16-010	AMD-E	92-06-004	222-24-050	AMD-S	92-11-069
220-110-035	NEW-W	92-15-095	222-16-010	AMD-P	92-07-093	222-24-050	AMD	92-15-011
220-110-050	AMD-P	92-11-082	222-16-010	AMD-S	92-11-069	222-24-060	AMD-P	92-07-093
220-110-050	AMD-W	92-15-095	222-16-010	AMD-E	92-12-038	222-24-060	AMD-S	92-11-069
220-110-060	AMD-P	92-11-082	222-16-010	AMD	92-15-011	222-24-060	AMD	92-15-011
220-110-060	AMD-W	92-15-095	222-16-020	AMD-P	92-07-093	222-30-010	AMD-P	92-07-093
220-110-070	AMD-P	92-11-082	222-16-020	REP-S	92-11-069	222-30-010	AMD-S	92-11-069
220-110-070	AMD-W	92-15-095	222-16-020	REP	92-15-011	222-30-010	AMD	92-15-011
220-110-080	AMD-P	92-11-082	222-16-030	AMD-P	92-07-093	222-30-020	AMD-P	92-07-093
220-110-080	AMD-W	92-15-095	222-16-030	AMD-S	92-11-069	222-30-020	AMD-S	92-11-069
220-110-090	REP-P	92-11-082	222-16-030	AMD	92-15-011	222-30-020	AMD	92-15-011
220-110-090	REP-W	92-15-095	222-16-035	NEW-P	92-07-093	222-30-025	NEW-P	92-07-093
220-110-100	AMD-P	92-11-082	222-16-035	NEW-S	92-11-069	222-30-025	NEW-S	92-11-069
220-110-100	AMD-W	92-15-095	222-16-035	NEW	92-15-011	222-30-025	NEW	92-15-011
220-110-110	REP-P	92-11-082	222-16-046	NEW-E	92-09-064	222-30-040	AMD-P	92-07-093
220-110-110	REP-W	92-15-095	222-16-050	AMD-E	92-06-004	222-30-040	AMD-S	92-11-069
220-110-120	AMD-P	92-11-082	222-16-050	AMD-P	92-07-093	222-30-040	AMD	92-15-011

Table of WAC Sections Affected

WAC #	WSR #	WAC #	WSR #	WAC #	WSR #			
222-30-050	AMD-P	92-07-093	232-12-175	NEW	92-09-076	236-12-013	REP	92-04-036
222-30-050	AMD-S	92-11-069	232-12-180	NEW	92-09-076	236-12-014	REP	92-04-036
222-30-050	AMD	92-15-011	232-12-267	AMD-P	92-02-086	236-12-015	NEW	92-04-036
222-30-060	AMD-P	92-07-093	232-12-267	AMD-C	92-05-018	236-12-040	REP	92-04-036
222-30-060	AMD-S	92-11-069	232-12-267	AMD	92-12-064	236-12-050	REP	92-04-036
222-30-060	AMD	92-15-011	232-12-277	AMD-P	92-02-086	236-12-060	REP	92-04-036
222-30-070	AMD-P	92-07-093	232-12-277	AMD-C	92-05-018	236-12-061	REP	92-04-036
222-30-070	AMD-S	92-11-069	232-12-277	AMD	92-12-064	236-12-120	REP	92-04-036
222-30-070	AMD	92-15-011	232-28-022	AMD-P	92-02-085	236-12-130	REP	92-04-036
222-30-090	AMD-P	92-07-093	232-28-022	AMD	92-06-017	236-12-131	REP	92-04-036
222-30-090	AMD-S	92-11-069	232-28-022	AMD-P	92-09-042	236-12-132	REP	92-04-036
222-30-090	AMD	92-15-011	232-28-022	AMD	92-12-065	236-12-133	REP	92-04-036
222-30-100	AMD-P	92-07-093	232-28-226	AMD-P	92-06-075	236-12-160	NEW	92-09-076
222-30-100	AMD-S	92-11-069	232-28-226	AMD	92-12-058	236-12-170	NEW	92-09-076
222-30-100	AMD	92-15-011	232-28-227	AMD-P	92-06-076	236-12-171	NEW	92-09-076
222-30-110	NEW-P	92-07-093	232-28-227	AMD	92-12-059	236-12-175	NEW	92-09-076
222-30-110	NEW-S	92-11-069	232-28-227	AMD-P	92-14-106	236-12-180	NEW	92-09-076
222-30-110	NEW	92-15-011	232-28-22701	NEW-E	92-12-019	236-12-185	NEW	92-04-036
222-30-120	NEW	92-08-025	232-28-228	AMD-P	92-02-087	236-12-186	NEW	92-04-036
222-34-040	AMD-P	92-07-093	232-28-228	AMD	92-06-018	236-12-187	NEW	92-04-036
222-38-010	AMD-P	92-07-093	232-28-228	AMD-P	92-06-077	236-12-188	NEW	92-04-036
222-38-010	AMD-S	92-11-069	232-28-228	AMD	92-12-060	236-12-189	NEW	92-04-036
222-38-010	AMD	92-15-011	232-28-229	REP-P	92-06-078	236-12-190	NEW	92-04-036
222-38-020	AMD-P	92-07-093	232-28-229	REP	92-12-061	236-12-191	NEW	92-04-036
222-38-020	AMD-S	92-11-069	232-28-230	REP-P	92-06-079	236-12-200	AMD	92-04-036
222-38-020	AMD	92-15-011	232-28-230	REP	92-12-062	236-12-220	AMD	92-04-036
222-38-030	NEW-P	92-07-093	232-28-231	REP-P	92-06-080	236-12-225	REP	92-04-036
222-38-030	NEW-S	92-11-069	232-28-231	REP	92-12-063	236-12-290	AMD	92-04-037
222-38-030	NEW	92-15-011	232-28-233	NEW-P	92-06-078	236-12-300	AMD	92-04-037
222-38-040	NEW-P	92-07-093	232-28-233	NEW	92-12-061	236-12-320	AMD	92-04-036
222-38-040	NEW-S	92-11-069	232-28-234	NEW-P	92-06-079	236-12-340	REP	92-04-036
222-38-040	NEW	92-15-011	232-28-234	NEW	92-12-062	236-12-350	NEW	92-04-036
230-04-201	AMD-P	92-15-055	232-28-235	NEW-P	92-06-080	236-12-351	NEW	92-04-036
230-08-010	AMD-P	92-14-018	232-28-235	NEW	92-12-063	236-12-360	NEW	92-04-036
230-08-025	AMD-P	92-14-018	232-28-415	REP-P	92-14-107	236-12-361	NEW	92-04-036
230-08-180	AMD-P	92-14-018	232-28-416	NEW-P	92-14-107	236-12-362	NEW	92-04-036
230-08-180	AMD-W	92-14-057	232-28-512	REP-P	92-14-108	236-12-365	NEW	92-04-036
230-08-180	AMD-P	92-15-055	232-28-513	NEW-P	92-14-108	236-12-370	NEW	92-04-036
230-08-240	REP-P	92-14-018	232-28-61825	NEW-E	92-03-013	236-12-371	NEW	92-04-036
230-08-240	REP-W	92-14-057	232-28-61826	NEW-E	92-05-022	236-12-372	NEW	92-04-036
230-08-240	REP-P	92-15-055	232-28-61827	NEW-E	92-05-021	236-14-010	NEW-P	92-10-082
230-20-670	AMD-P	92-15-055	232-28-61828	NEW-E	92-05-019	236-14-015	NEW-P	92-10-082
230-20-685	NEW-C	92-08-057	232-28-61829	NEW-E	92-05-024	236-14-100	NEW-P	92-10-082
230-50-010	AMD-P	92-14-018	232-28-61830	NEW-E	92-08-067	236-14-900	NEW-P	92-10-082
230-50-010	AMD-E	92-14-019	232-28-61831	NEW-E	92-08-068	236-22-010	NEW-P	92-09-155
230-50-012	AMD-P	92-14-018	232-28-61901	NEW-P	92-02-088	236-22-010	NEW	92-12-092
230-50-012	AMD-E	92-14-019	232-28-61901	NEW	92-07-038	236-22-100	NEW-P	92-09-155
230-50-015	NEW-P	92-14-018	232-28-61902	NEW-P	92-02-089	236-22-100	NEW	92-12-092
230-50-015	NEW-E	92-14-019	232-28-61902	NEW	92-07-039	236-48-190	AMD-P	92-05-042
230-50-018	NEW-P	92-14-018	232-28-61903	NEW-P	92-02-090	236-48-190	AMD	92-09-016
230-50-018	NEW-E	92-14-019	232-28-61903	NEW-W	92-07-037	240-10-040	AMD-E	92-09-096
230-50-150	AMD-P	92-14-018	232-28-61904	NEW-P	92-02-091	240-15-005	AMD-P	92-08-060
230-50-150	AMD-E	92-14-019	232-28-61904	NEW	92-07-040	240-15-005	AMD	92-11-017
230-50-235	NEW-P	92-14-018	232-28-61905	NEW-P	92-02-092	240-15-010	AMD-P	92-08-060
230-50-235	NEW-E	92-14-019	232-28-61905	NEW	92-07-041	240-15-010	AMD	92-11-017
230-50-580	AMD-E	92-06-033	232-28-61906	NEW-P	92-02-093	240-15-015	AMD-P	92-08-060
230-50-580	AMD-P	92-14-018	232-28-61906	NEW	92-07-042	240-15-015	AMD	92-11-017
230-50-580	AMD-E	92-14-020	232-28-61907	NEW-E	92-05-020	240-15-020	AMD-P	92-08-060
232-12-017	AMD-E	92-14-015	232-28-61907	NEW-P	92-06-073	240-15-020	AMD	92-11-017
232-12-021	AMD-P	92-02-086	232-28-61907	NEW	92-11-079	240-15-025	AMD-P	92-08-060
232-12-021	AMD-C	92-05-018	232-28-61908	NEW-P	92-06-074	240-15-025	AMD	92-11-017
232-12-021	AMD-W	92-12-057	232-28-61908	NEW	92-11-080	240-15-030	AMD-P	92-08-060
232-12-021	AMD-E	92-14-014	232-28-61909	NEW-P	92-09-136	240-15-030	AMD	92-11-017
232-12-064	AMD-E	92-14-014	232-28-61909	NEW-E	92-12-020	240-15-035	AMD-P	92-08-060
232-12-074	AMD-P	92-02-086	232-28-61910	NEW-P	92-14-100	240-15-035	AMD	92-11-017
232-12-074	AMD-C	92-05-018	232-28-61911	NEW-P	92-14-101	242-02-010	NEW-E	92-14-001
232-12-074	AMD-W	92-12-057	232-28-61912	NEW-P	92-14-104	242-02-010	NEW-P	92-15-134
232-12-077	AMD-P	92-02-086	232-28-61913	NEW-P	92-14-102	242-02-020	NEW-E	92-14-001
232-12-077	AMD-C	92-05-018	232-28-61914	NEW-P	92-14-103	242-02-020	NEW-P	92-15-134
232-12-077	AMD-W	92-12-057	232-28-61915	NEW-E	92-14-013	242-02-030	NEW-E	92-14-001
232-12-141	AMD-P	92-14-105	232-28-714	REP-P	92-02-094	242-02-030	NEW-P	92-15-134
232-12-147	AMD-P	92-06-072	232-28-714	REP	92-06-019	242-02-040	NEW-E	92-14-001
232-12-147	AMD-E	92-08-066	236-12-001	AMD	92-04-036	242-02-040	NEW-P	92-15-134
232-12-147	AMD	92-11-078	236-12-010	REP	92-04-036	242-02-050	NEW-E	92-14-001
232-12-160	NEW	92-09-076	236-12-011	REP	92-04-036	242-02-050	NEW-P	92-15-134
232-12-170	NEW	92-09-076	236-12-011	AMD-W	92-11-039	242-02-052	NEW-E	92-14-001
232-12-171	NEW	92-09-076	236-12-012	REP	92-04-036	242-02-052	NEW-P	92-15-134



Table of WAC Sections Affected

WAC #	WSR #	WAC #	WSR #	WAC #	WSR #			
246-215-069	REP-P	92-03-142	246-215-270	NEW	92-08-112	246-358-035	AMD	92-04-082
246-215-069	REP	92-08-112	246-215-280	NEW-P	92-03-142	246-358-045	AMD	92-04-082
246-215-070	NEW-P	92-03-142	246-215-280	NEW	92-08-112	246-358-055	AMD	92-04-082
246-215-070	NEW	92-08-112	246-215-290	NEW-P	92-03-142	246-358-075	AMD	92-04-082
246-215-079	REP-P	92-03-142	246-215-290	NEW	92-08-112	246-358-095	AMD	92-04-082
246-215-079	REP	92-08-112	246-215-300	NEW-P	92-03-142	246-358-105	AMD	92-04-082
246-215-080	NEW-P	92-03-142	246-215-300	NEW	92-08-112	246-358-115	AMD	92-04-082
246-215-080	NEW	92-08-112	246-215-500	REP-P	92-03-142	246-358-125	AMD	92-04-082
246-215-089	REP-P	92-03-142	246-215-500	REP	92-08-112	246-358-135	AMD	92-04-082
246-215-089	REP	92-08-112	246-215-900	REP-P	92-03-142	246-358-145	AMD	92-04-082
246-215-090	NEW-P	92-03-142	246-215-900	REP	92-08-112	246-358-155	AMD	92-04-082
246-215-090	NEW	92-08-112	246-217-030	AMD-P	92-09-144	246-358-175	AMD	92-04-082
246-215-099	REP-P	92-03-142	246-217-030	AMD	92-14-093	246-388-070	AMD-P	92-15-085
246-215-099	REP	92-08-112	246-221-090	AMD	92-06-008	246-388-072	NEW-P	92-15-085
246-215-100	NEW-P	92-03-142	246-235-160	NEW	92-05-011	246-390-001	NEW-P	92-07-078
246-215-100	NEW	92-08-112	246-232-050	AMD	92-06-008	246-390-001	NEW	92-15-152
246-215-109	REP-P	92-03-142	246-235-075	NEW	92-06-008	246-390-010	NEW-P	92-07-078
246-215-109	REP	92-08-112	246-239-010	AMD	92-06-008	246-390-010	NEW	92-15-152
246-215-110	NEW-P	92-03-142	246-239-015	NEW-W	92-13-074	246-390-020	NEW-P	92-07-078
246-215-110	NEW	92-08-112	246-239-025	NEW	92-06-008	246-390-020	NEW	92-15-152
246-215-119	REP-P	92-03-142	246-240-010	NEW	92-06-008	246-390-030	NEW-P	92-07-078
246-215-119	REP	92-08-112	246-240-015	NEW-W	92-13-074	246-390-030	NEW	92-15-152
246-215-120	NEW-P	92-03-142	246-240-050	NEW	92-06-008	246-390-040	NEW-P	92-07-078
246-215-120	NEW	92-08-112	246-243-050	AMD	92-06-008	246-390-040	NEW	92-15-152
246-215-129	REP-P	92-03-142	246-243-190	AMD	92-06-008	246-390-050	NEW-P	92-07-078
246-215-129	REP	92-08-112	246-290-010	AMD	92-04-070	246-390-050	NEW	92-15-152
246-215-130	NEW-P	92-03-142	246-290-300	AMD	92-04-070	246-390-060	NEW-P	92-07-078
246-215-130	NEW	92-08-112	246-290-310	AMD	92-04-070	246-390-060	NEW	92-15-152
246-215-139	REP-P	92-03-142	246-290-320	AMD	92-04-070	246-390-070	NEW-P	92-07-078
246-215-139	REP	92-08-112	246-290-330	AMD	92-04-070	246-390-070	NEW	92-15-152
246-215-140	NEW-P	92-03-142	246-290-480	AMD	92-04-070	246-390-100	NEW-P	92-07-078
246-215-140	NEW	92-08-112	246-290-990	PREP	92-10-025	246-390-100	NEW	92-15-152
246-215-149	REP-P	92-03-142	246-310-020	AMD	92-05-057	246-390-990	NEW-P	92-15-149
246-215-149	REP	92-08-112	246-310-132	AMD-P	92-09-086	246-510-400	NEW-P	92-07-077
246-215-150	NEW-P	92-03-142	246-310-132	AMD-E	92-09-087	246-510-400	NEW	92-14-055
246-215-150	NEW	92-08-112	246-310-135	NEW	92-05-057	246-762-010	AMD-P	92-02-096
246-215-159	REP-P	92-03-142	246-310-136	NEW	92-05-057	246-762-010	AMD	92-06-067
246-215-159	REP	92-08-112	246-310-250	REP	92-12-015	246-762-020	AMD-P	92-02-096
246-215-160	NEW-P	92-03-142	246-310-261	NEW	92-12-015	246-762-020	AMD	92-06-067
246-215-160	NEW	92-08-112	246-310-262	NEW	92-12-015	246-762-040	AMD-P	92-02-096
246-215-169	REP-P	92-03-142	246-316-020	AMD-P	92-15-085	246-762-040	AMD	92-06-067
246-215-169	REP	92-08-112	246-316-040	AMD-P	92-15-085	246-802-025	NEW-P	92-14-128
246-215-170	NEW-P	92-03-142	246-316-045	NEW-P	92-15-085	246-802-030	AMD-P	92-14-128
246-215-170	NEW	92-08-112	246-316-050	AMD-P	92-15-085	246-802-090	AMD-P	92-14-128
246-215-179	REP-P	92-03-142	246-316-990	AMD-P	92-07-097	246-802-130	AMD-P	92-14-128
246-215-179	REP	92-08-112	246-316-990	AMD	92-12-086	246-802-150	REP-P	92-14-128
246-215-180	NEW-P	92-03-142	246-318-040	AMD-P	92-15-085	246-802-160	AMD-P	92-14-128
246-215-180	NEW	92-08-112	246-318-042	NEW-P	92-15-085	246-802-240	AMD-P	92-14-128
246-215-189	REP-P	92-03-142	246-318-990	AMD-P	92-07-097	246-802-250	AMD-P	92-14-128
246-215-189	REP	92-08-112	246-318-990	AMD	92-12-028	246-802-990	AMD-P	92-14-128
246-215-190	NEW-P	92-03-142	246-321-018	NEW-P	92-15-085	246-806-050	REP-P	92-12-090
246-215-190	NEW	92-08-112	246-322-990	AMD-P	92-07-097	246-806-060	AMD-P	92-12-090
246-215-199	REP-P	92-03-142	246-322-990	AMD	92-12-028	246-806-070	AMD-P	92-12-090
246-215-199	REP	92-08-112	246-322-991	AMD-P	92-07-097	246-806-085	NEW-P	92-12-090
246-215-200	NEW-P	92-03-142	246-322-991	AMD	92-12-028	246-806-090	AMD-P	92-12-090
246-215-200	NEW	92-08-112	246-323-022	NEW-P	92-15-085	246-806-180	AMD-P	92-12-090
246-215-209	REP-P	92-03-142	246-323-990	AMD-P	92-10-014	246-806-990	AMD-P	92-03-140
246-215-209	REP	92-08-112	246-323-990	AMD	92-15-048	246-806-990	AMD	92-07-017
246-215-210	NEW-P	92-03-142	246-325-022	NEW-P	92-15-085	246-807-300	AMD-E	92-09-080
246-215-210	NEW	92-08-112	246-325-990	AMD-P	92-10-014	246-807-300	RESCIND	92-12-007
246-215-219	REP-P	92-03-142	246-325-990	AMD	92-15-048	246-807-300	AMD-E	92-12-008
246-215-219	REP	92-08-112	246-326-990	AMD-P	92-07-097	246-807-480	NEW-P	92-06-065
246-215-220	NEW-P	92-03-142	246-326-990	AMD	92-12-028	246-807-480	NEW-E	92-06-066
246-215-220	NEW	92-08-112	246-327-090	NEW-P	92-15-085	246-807-480	NEW	92-11-009
246-215-229	REP-P	92-03-142	246-327-990	AMD-P	92-10-013	246-815-031	AMD	92-03-006
246-215-229	REP	92-08-112	246-327-990	AMD	92-15-084	246-815-090	AMD-P	92-11-014
246-215-230	NEW-P	92-03-142	246-329-035	NEW-P	92-15-085	246-815-090	AMD	92-15-033
246-215-230	NEW	92-08-112	246-331-100	AMD-P	92-15-085	246-815-115	NEW	92-03-126
246-215-239	REP-P	92-03-142	246-331-990	AMD-P	92-10-013	246-816-050	AMD	92-05-012
246-215-239	REP	92-08-112	246-331-990	AMD	92-15-084	246-816-160	NEW-P	92-02-098
246-215-240	NEW-P	92-03-142	246-336-100	AMD-P	92-15-085	246-816-160	NEW-W	92-06-007
246-215-240	NEW	92-08-112	246-336-990	AMD-P	92-10-013	246-816-201	AMD	92-05-012
246-215-250	NEW-P	92-03-142	246-336-990	AMD	92-15-084	246-816-210	AMD	92-05-012
246-215-250	NEW	92-08-112	246-340-085	NEW-P	92-15-085	246-816-230	AMD	92-05-012
246-215-260	NEW-P	92-03-142	246-358-001	AMD	92-04-082	246-816-250	AMD	92-05-012
246-215-260	NEW	92-08-112	246-358-010	AMD	92-04-082	246-816-260	AMD	92-05-012
246-215-270	NEW-P	92-03-142	246-358-025	AMD	92-04-082	246-816-301	AMD	92-05-012

### Table of WAC Sections Affected

WAC #	WSR #	WAC #	WSR #	WAC #	WSR #			
246-816-310	AMD	92-05-012	246-851-360	AMD-P	92-14-092	246-869-020	AMD-P	92-07-098
246-816-360	AMD	92-05-012	246-851-440	NEW-P	92-02-095	246-869-020	AMD	92-12-035
246-816-370	AMD	92-05-012	246-851-440	NEW	92-06-030	246-869-050	AMD-P	92-07-098
246-816-390	AMD	92-05-012	246-851-450	NEW-P	92-02-095	246-869-050	AMD	92-12-035
246-816-410	AMD	92-05-012	246-851-450	NEW	92-06-030	246-869-070	AMD-P	92-07-098
246-816-510	AMD	92-05-012	246-851-460	NEW-P	92-02-095	246-869-070	AMD	92-12-035
246-816-610	NEW-W	92-05-085	246-851-460	NEW	92-06-030	246-869-095	NEW-P	92-03-095
246-816-620	NEW-W	92-05-085	246-851-470	NEW-P	92-02-095	246-869-095	NEW	92-14-032
246-816-630	NEW-W	92-05-085	246-851-470	NEW	92-06-030	246-869-100	AMD-P	92-07-098
246-816-640	NEW-W	92-05-085	246-851-480	NEW-P	92-02-095	246-869-100	AMD	92-12-035
246-816-650	NEW-W	92-05-085	246-851-480	NEW	92-06-030	246-869-120	AMD-P	92-07-098
246-816-660	NEW-W	92-05-085	246-851-490	NEW-P	92-02-095	246-869-120	AMD	92-12-035
246-816-670	NEW-W	92-05-085	246-851-490	NEW	92-06-030	246-869-190	AMD-P	92-07-098
246-816-680	NEW-W	92-05-085	246-851-520	NEW-P	92-14-092	246-869-190	AMD	92-12-035
246-816-701	NEW-W	92-06-063	246-851-530	NEW-P	92-14-092	246-869-210	AMD-P	92-07-098
246-816-701	NEW-P	92-06-064	246-851-990	AMD	92-06-029	246-869-210	AMD	92-12-035
246-816-701	NEW	92-09-069	246-853-025	NEW-P	92-13-065	246-869-220	AMD-P	92-07-098
246-816-710	NEW-W	92-06-063	246-853-045	NEW-P	92-13-065	246-869-220	AMD	92-12-035
246-816-710	NEW-P	92-06-064	246-853-135	NEW-P	92-13-065	246-869-240	AMD-P	92-04-040
246-816-710	NEW	92-09-069	246-853-400	NEW-P	92-13-065	246-869-240	AMD	92-08-058
246-816-720	NEW-W	92-06-063	246-853-990	AMD-P	92-06-028	246-871-040	AMD-P	92-07-098
246-816-720	NEW-P	92-06-064	246-853-990	AMD	92-14-054	246-871-040	AMD	92-12-035
246-816-720	NEW	92-09-069	246-857-020	AMD-P	92-07-098	246-873-060	AMD-P	92-07-098
246-816-730	NEW-W	92-06-063	246-857-020	AMD	92-12-035	246-873-060	AMD	92-12-035
246-816-730	NEW-P	92-06-064	246-857-180	AMD-P	92-07-098	246-873-080	AMD-P	92-07-098
246-816-730	NEW	92-09-069	246-857-180	AMD	92-12-035	246-873-080	AMD	92-12-035
246-816-740	NEW-W	92-06-063	246-857-320	AMD-P	92-07-098	246-875-020	AMD-P	92-07-098
246-816-740	NEW-P	92-06-064	246-857-320	AMD	92-12-035	246-875-020	AMD	92-12-035
246-816-740	NEW	92-09-069	246-857-330	AMD-P	92-07-098	246-875-060	AMD-P	92-07-098
246-818-990	AMD-P	92-13-009	246-857-330	AMD	92-12-035	246-875-060	AMD	92-12-035
246-818-990	AMD-E	92-13-010	246-857-340	AMD-P	92-07-098	246-875-070	AMD-P	92-07-098
246-828-005	NEW-W	92-09-109	246-857-340	AMD	92-12-035	246-875-070	AMD	92-12-035
246-830-401	AMD-P	92-03-139	246-858-020	AMD-P	92-07-098	246-875-080	AMD-P	92-07-098
246-830-401	AMD	92-15-153	246-858-020	AMD	92-12-035	246-875-080	AMD	92-12-035
246-830-410	AMD-P	92-03-139	246-858-030	AMD-P	92-07-098	246-875-090	REP-P	92-07-098
246-830-410	AMD	92-15-153	246-858-030	AMD	92-12-035	246-875-090	REP	92-12-035
246-830-420	AMD-P	92-03-139	246-858-040	AMD-P	92-07-098	246-879-010	AMD-P	92-10-070
246-830-420	AMD	92-15-153	246-858-040	AMD	92-12-035	246-879-010	AMD	92-15-069
246-830-430	AMD-P	92-03-139	246-858-060	AMD-P	92-07-098	246-879-020	AMD-P	92-07-098
246-830-430	AMD	92-15-153	246-858-060	AMD	92-12-035	246-879-020	AMD-W	92-10-026
246-830-440	AMD-P	92-03-139	246-858-070	AMD-P	92-07-098	246-879-020	AMD-P	92-10-070
246-830-440	AMD	92-15-153	246-858-070	AMD	92-12-035	246-879-020	AMD	92-15-069
246-830-450	AMD-P	92-03-139	246-861-010	NEW	92-03-029	246-879-030	AMD-P	92-07-098
246-830-450	AMD	92-15-153	246-861-020	AMD	92-03-029	246-879-030	AMD-W	92-10-026
246-836-210	NEW-P	92-02-097	246-861-030	AMD	92-03-029	246-879-030	AMD-P	92-10-070
246-836-210	NEW	92-06-020	246-861-040	AMD	92-03-029	246-879-030	AMD	92-15-069
246-838-010	AMD-P	92-12-088	246-861-050	AMD	92-03-029	246-879-040	AMD-P	92-07-098
246-838-030	AMD-P	92-12-088	246-861-060	AMD	92-03-029	246-879-040	AMD-W	92-10-026
246-838-050	AMD-P	92-12-088	246-861-070	REP	92-03-029	246-879-040	AMD-P	92-10-070
246-838-240	AMD-P	92-12-088	246-861-080	REP	92-03-029	246-879-040	AMD	92-15-069
246-838-320	NEW-P	92-12-088	246-861-090	AMD	92-03-029	246-879-050	AMD-P	92-10-070
246-839-300	AMD-P	92-14-126	246-861-095	NEW	92-03-029	246-879-050	AMD	92-15-069
246-839-310	AMD-P	92-14-126	246-861-100	REP	92-03-029	246-879-060	AMD-P	92-10-070
246-839-320	AMD-P	92-14-126	246-861-110	REP	92-03-029	246-879-060	AMD	92-15-069
246-839-330	AMD-P	92-14-126	246-861-120	AMD	92-03-029	246-879-070	AMD-P	92-07-098
246-847-010	AMD-P	92-09-153	246-863-060	AMD-P	92-07-098	246-879-070	AMD-W	92-10-026
246-847-055	NEW-P	92-09-153	246-863-060	AMD	92-12-035	246-879-070	AMD-P	92-10-070
246-847-065	AMD-P	92-09-153	246-863-070	AMD-P	92-07-098	246-879-070	AMD	92-15-069
246-847-068	NEW-P	92-09-153	246-863-070	AMD	92-12-035	246-879-080	AMD-P	92-07-098
246-847-070	AMD-P	92-09-153	246-863-080	AMD-P	92-03-124	246-879-080	AMD-W	92-10-026
246-847-080	AMD-P	92-09-153	246-863-080	AMD-P	92-07-098	246-879-080	AMD-P	92-10-070
246-847-110	AMD-P	92-09-153	246-863-080	AMD-W	92-08-061	246-879-080	AMD	92-15-069
246-847-117	NEW-P	92-09-153	246-863-080	AMD	92-12-035	246-879-100	NEW-P	92-10-070
246-847-125	NEW-P	92-09-153	246-863-090	AMD-P	92-07-098	246-879-100	NEW	92-15-069
246-847-340	NEW-P	92-09-153	246-863-090	AMD	92-12-035	246-879-110	NEW-P	92-10-070
246-847-350	NEW-P	92-09-153	246-863-110	AMD-P	92-07-098	246-879-110	NEW	92-15-069
246-847-360	NEW-P	92-09-153	246-863-110	AMD	92-12-035	246-879-120	NEW	92-15-069
246-847-370	NEW-P	92-09-153	246-865-030	AMD-P	92-07-098	246-883-020	AMD-P	92-03-096
246-851-030	REP-P	92-02-095	246-865-030	AMD	92-12-035	246-883-020	AMD	92-09-070
246-851-030	REP	92-06-030	246-865-060	AMD-P	92-07-098	246-883-025	NEW-P	92-04-041
246-851-050	REP-P	92-02-095	246-865-060	AMD	92-12-035	246-883-025	NEW	92-09-072
246-851-050	REP	92-06-030	246-865-070	AMD-P	92-07-098	246-883-030	AMD-P	92-03-096
246-851-090	AMD-P	92-02-095	246-865-070	AMD	92-12-035	246-883-030	AMD-W	92-09-001
246-851-090	AMD	92-06-030	246-867-010	AMD-P	92-07-098	246-883-040	AMD-P	92-07-098
246-851-270	PREP	92-03-032	246-867-010	AMD	92-12-035	246-883-040	AMD	92-12-035
246-851-270	AMD-P	92-14-092	246-867-060	AMD-P	92-07-098	246-883-050	NEW-P	92-03-096
246-851-360	PREP	92-03-032	246-867-060	AMD	92-12-035	246-883-050	NEW	92-09-070



Table of WAC Sections Affected

WAC #	WSR #	WAC #	WSR #	WAC #	WSR #			
246-886-020	AMD-P	92-07-098	246-907-030	AMD	92-07-099	246-918-340	REP-P	92-08-063
246-886-020	AMD	92-12-035	246-915-010	AMD	92-08-039	246-918-340	REP	92-12-089
246-886-030	AMD-P	92-07-098	246-915-015	AMD	92-08-039	246-918-350	REP-P	92-08-063
246-886-030	AMD	92-12-035	246-915-015	REP-P	92-08-111	246-918-350	REP	92-12-089
246-886-060	AMD-P	92-07-098	246-915-030	AMD-W	92-08-110	246-918-360	REP-P	92-08-063
246-886-060	AMD	92-12-035	246-915-030	AMD-P	92-08-111	246-918-360	REP	92-12-089
246-887-020	AMD	92-04-029	246-915-075	NEW-P	92-08-111	246-918-370	REP-P	92-08-063
246-887-040	AMD	92-04-029	246-915-120	AMD	92-08-039	246-918-370	REP	92-12-089
246-887-050	AMD-P	92-07-098	246-915-150	AMD	92-08-039	246-920-030	AMD-E	92-07-058
246-887-050	AMD	92-12-035	246-915-180	AMD	92-08-039	246-920-030	RESCIND	92-07-096
246-887-060	AMD-P	92-07-098	246-915-185	NEW	92-08-039	246-920-030	AMD-E	92-07-096
246-887-060	AMD	92-12-035	246-915-200	AMD	92-08-039	246-920-030	AMD-P	92-10-069
246-887-070	AMD-P	92-07-098	246-917-125	NEW	92-08-021	246-922-990	AMD-P	92-06-058
246-887-070	AMD	92-12-035	246-917-126	NEW	92-08-021	246-922-990	AMD	92-14-053
246-887-100	AMD	92-04-029	246-917-990	AMD	92-08-062	246-924-115	NEW-P	92-15-151
246-887-140	AMD	92-04-029	246-918-005	NEW-P	92-08-063	246-924-115	NEW-E	92-15-154
246-887-160	AMD	92-04-029	246-918-005	NEW	92-12-089	246-924-355	NEW-P	92-15-148
246-887-170	AMD	92-04-029	246-918-006	NEW-P	92-08-063	246-924-991	NEW-E	92-03-107
246-887-200	AMD-P	92-07-098	246-918-006	NEW	92-12-089	246-924-991	NEW-P	92-03-141
246-887-200	AMD	92-12-035	246-918-007	NEW-P	92-08-063	246-924-991	NEW-W	92-07-016
246-887-210	NEW-P	92-04-042	246-918-007	NEW	92-12-089	246-924-992	NEW-E	92-03-107
246-887-210	NEW	92-09-071	246-918-008	NEW-P	92-08-063	246-924-992	NEW-P	92-03-141
246-889-020	AMD-P	92-07-098	246-918-008	NEW	92-12-089	246-924-992	NEW-W	92-07-016
246-889-020	AMD	92-12-035	246-918-020	REP-P	92-08-063	246-926-020	AMD	92-05-010
246-889-030	AMD-P	92-07-098	246-918-020	REP	92-12-089	246-926-030	AMD	92-05-010
246-889-030	AMD	92-12-035	246-918-030	AMD-P	92-08-063	246-926-040	AMD	92-05-010
246-889-040	AMD-P	92-07-098	246-918-030	AMD	92-12-089	246-926-060	AMD	92-05-010
246-889-040	AMD	92-12-035	246-918-035	AMD-P	92-08-063	246-926-070	AMD	92-05-010
246-893-020	AMD-P	92-07-098	246-918-035	AMD	92-12-089	246-926-080	AMD	92-05-010
246-893-020	AMD	92-12-035	246-918-040	REP-P	92-08-063	246-926-090	AMD	92-05-010
246-893-030	AMD-P	92-07-098	246-918-040	REP	92-12-089	246-926-110	AMD	92-05-010
246-893-030	AMD	92-12-035	246-918-060	REP-P	92-08-063	246-926-120	AMD	92-05-010
246-893-040	AMD-P	92-07-098	246-918-060	REP	92-12-089	246-926-130	AMD	92-05-010
246-893-040	AMD	92-12-035	246-918-090	AMD-P	92-08-063	246-926-150	AMD	92-05-010
246-893-090	AMD-P	92-07-098	246-918-090	AMD	92-12-089	246-926-160	AMD	92-05-010
246-893-090	AMD	92-12-035	246-918-100	REP-P	92-08-063	246-926-170	AMD	92-05-010
246-893-120	AMD-P	92-07-098	246-918-100	REP	92-12-089	246-926-180	AMD-P	92-15-150
246-893-120	AMD	92-12-035	246-918-110	AMD-P	92-08-063	246-926-190	AMD	92-05-010
246-893-130	AMD-P	92-07-098	246-918-110	AMD	92-12-089	246-926-200	AMD	92-05-010
246-893-130	AMD	92-12-035	246-918-120	AMD-P	92-08-063	246-926-990	AMD	92-05-010
246-893-998	AMD-P	92-07-098	246-918-120	AMD	92-12-089	246-928-020	AMD-P	92-10-071
246-893-998	AMD	92-12-035	246-918-130	AMD-P	92-08-063	246-928-020	AMD	92-15-032
246-895-020	AMD-P	92-07-098	246-918-130	AMD	92-12-089	246-928-085	NEW-P	92-10-071
246-895-020	AMD	92-12-035	246-918-140	AMD-P	92-08-063	246-928-085	NEW	92-15-032
246-895-040	AMD-P	92-07-098	246-918-140	AMD	92-12-089	246-928-990	AMD-P	92-10-071
246-895-040	AMD	92-12-035	246-918-160	AMD-P	92-08-063	246-928-990	AMD	92-15-032
246-895-080	AMD-P	92-07-098	246-918-160	AMD	92-12-089	246-930-010	AMD-P	92-07-079
246-895-080	AMD	92-12-035	246-918-170	AMD-P	92-08-063	246-930-010	AMD	92-12-027
246-895-100	AMD-P	92-07-098	246-918-170	AMD	92-12-089	246-930-020	AMD-P	92-07-079
246-895-100	AMD	92-12-035	246-918-180	AMD-P	92-08-063	246-930-020	AMD	92-12-027
246-895-120	AMD-P	92-07-098	246-918-180	AMD	92-12-089	246-930-030	AMD-P	92-07-079
246-895-120	AMD	92-12-035	246-918-190	REP-P	92-08-063	246-930-030	AMD	92-12-027
246-895-130	AMD-P	92-07-098	246-918-190	REP	92-12-089	246-930-040	AMD-P	92-07-079
246-895-130	AMD	92-12-035	246-918-200	REP-P	92-08-063	246-930-040	AMD	92-12-027
246-895-140	AMD-P	92-07-098	246-918-200	REP	92-12-089	246-930-050	AMD-P	92-07-079
246-895-140	AMD	92-12-035	246-918-210	REP-P	92-08-063	246-930-050	AMD	92-12-027
246-895-160	AMD-P	92-07-098	246-918-210	REP	92-12-089	246-930-060	AMD-P	92-07-079
246-895-160	AMD	92-12-035	246-918-220	REP-P	92-08-063	246-930-060	AMD	92-12-027
246-895-170	AMD-P	92-07-098	246-918-220	REP	92-12-089	246-930-075	AMD-P	92-07-079
246-895-170	AMD	92-12-035	246-918-240	REP-P	92-08-063	246-930-075	AMD	92-12-027
246-897-040	AMD-P	92-07-098	246-918-240	REP	92-12-089	246-930-200	AMD-P	92-07-079
246-897-040	AMD	92-12-035	246-918-250	AMD-P	92-08-063	246-930-200	AMD	92-12-027
246-897-050	AMD-P	92-07-098	246-918-250	AMD	92-12-089	246-930-210	AMD-P	92-07-079
246-897-050	AMD	92-12-035	246-918-260	AMD-P	92-08-063	246-930-210	AMD	92-12-027
246-897-150	AMD-P	92-07-098	246-918-260	AMD	92-12-089	246-930-220	AMD-P	92-07-079
246-897-150	AMD	92-12-035	246-918-270	REP-P	92-08-063	246-930-220	AMD	92-12-027
246-899-040	AMD-P	92-07-098	246-918-270	REP	92-12-089	246-930-300	AMD-P	92-07-079
246-899-040	AMD	92-12-035	246-918-280	REP-P	92-08-063	246-930-300	AMD	92-12-027
246-899-050	AMD-P	92-07-098	246-918-280	REP	92-12-089	246-930-301	AMD-P	92-07-079
246-899-050	AMD	92-12-035	246-918-290	REP-P	92-08-063	246-930-301	AMD	92-12-027
246-901-020	AMD-P	92-07-098	246-918-290	REP	92-12-089	246-930-310	AMD-P	92-07-079
246-901-020	AMD	92-12-035	246-918-300	REP-P	92-08-063	246-930-310	AMD	92-12-027
246-903-010	AMD-P	92-07-098	246-918-300	REP	92-12-089	246-930-320	AMD-P	92-07-079
246-903-010	AMD	92-12-035	246-918-320	REP-P	92-08-063	246-930-320	AMD	92-12-027
246-907-020	AMD-P	92-03-124	246-918-320	REP	92-12-089	246-930-330	AMD-P	92-07-079
246-907-020	AMD	92-07-099	246-918-330	REP-P	92-08-063	246-930-330	AMD	92-12-027
246-907-030	AMD-P	92-03-124	246-918-330	REP	92-12-089	246-930-340	AMD-P	92-07-079



Table of WAC Sections Affected

WAC #	WSR #	WAC #	WSR #	WAC #	WSR #			
246-930-340	AMD	92-12-027	246-976-070	NEW-P	92-15-034	246-977-070	REP-P	92-15-034
246-930-400	AMD-P	92-07-079	246-976-075	NEW-P	92-15-034	246-977-080	REP-P	92-15-034
246-930-400	AMD	92-12-027	246-976-080	NEW-P	92-15-034	246-977-090	REP-P	92-15-034
246-930-410	NEW-P	92-07-079	246-976-085	NEW-P	92-15-034	246-977-100	REP-P	92-15-034
246-930-410	NEW	92-12-027	246-976-090	NEW-P	92-15-034	246-977-110	REP-P	92-15-034
246-930-499	AMD-P	92-07-079	246-976-110	NEW-P	92-15-034	248-14-120	AMD-P	92-03-015
246-930-499	AMD	92-12-027	246-976-115	NEW-P	92-15-034	248-14-120	AMD	92-08-074
246-930-990	AMD-P	92-07-079	246-976-120	NEW-P	92-15-034	248-14-250	AMD-P	92-03-015
246-930-990	AMD	92-12-027	246-976-140	NEW-P	92-15-034	248-14-250	AMD	92-08-074
246-933-120	REP-P	92-14-127	246-976-150	NEW-P	92-15-034	248-14-285	AMD-P	92-03-015
246-933-170	AMD-P	92-14-127	246-976-160	NEW-P	92-15-034	248-14-285	AMD	92-08-074
246-933-240	REP-P	92-14-127	246-976-170	NEW-P	92-15-034	250-20-021	AMD-C	92-08-076
246-933-250	AMD	92-03-074	246-976-180	NEW-P	92-15-034	250-20-021	AMD-C	92-09-141
246-933-250	AMD-P	92-14-127	246-976-190	NEW-P	92-15-034	250-20-021	AMD	92-11-022
246-933-270	AMD-P	92-14-127	246-976-200	NEW-P	92-15-034	250-20-021	AMD-E	92-11-023
246-933-280	AMD	92-03-074	246-976-210	NEW-P	92-15-034	250-25-010	NEW	92-03-002
246-933-300	NEW	92-03-074	246-976-220	NEW-P	92-15-034	250-25-020	NEW	92-03-002
246-933-300	AMD-P	92-14-127	246-976-230	NEW-P	92-15-034	250-25-030	NEW	92-03-002
246-933-305	NEW	92-03-074	246-976-240	NEW-P	92-15-034	250-25-040	NEW	92-03-002
246-933-320	AMD-P	92-14-127	246-976-260	NEW-P	92-15-034	250-25-045	NEW	92-03-002
246-933-980	AMD-P	92-03-125	246-976-270	NEW-P	92-15-034	250-25-050	NEW	92-03-002
246-933-980	AMD	92-07-036	246-976-280	NEW-P	92-15-034	250-25-060	NEW	92-03-002
246-933-990	AMD-P	92-03-125	246-976-290	NEW-P	92-15-034	250-25-070	NEW	92-03-002
246-933-990	AMD	92-07-036	246-976-300	NEW-P	92-15-034	250-25-080	NEW	92-03-002
246-935-125	NEW-P	92-03-125	246-976-310	NEW-P	92-15-034	250-25-090	NEW	92-03-002
246-935-125	NEW	92-07-036	246-976-320	NEW-P	92-15-034	250-66-020	AMD-P	92-13-076
246-935-990	AMD-P	92-03-125	246-976-330	NEW-P	92-15-034	250-66-020	AMD-C	92-15-135
246-935-990	AMD	92-07-036	246-976-340	NEW-P	92-15-034	250-66-030	AMD-P	92-13-076
246-975-001	REP-P	92-15-034	246-976-350	NEW-P	92-15-034	250-66-030	AMD-C	92-15-135
246-975-010	REP-P	92-15-034	246-976-370	NEW-P	92-15-034	250-66-040	AMD-P	92-13-076
246-975-020	REP-P	92-15-034	246-976-390	NEW-P	92-15-034	250-66-040	AMD-C	92-15-135
246-975-030	REP-P	92-15-034	246-976-400	NEW-P	92-15-034	250-66-060	AMD-P	92-13-076
246-975-040	REP-P	92-15-034	246-976-420	NEW-P	92-15-034	250-66-060	AMD-C	92-15-135
246-975-050	REP-P	92-15-034	246-976-430	NEW-P	92-15-034	250-67-010	REP	92-03-002
246-975-060	REP-P	92-15-034	246-976-440	NEW-P	92-15-034	250-67-020	REP	92-03-002
246-975-070	REP-P	92-15-034	246-976-450	NEW-P	92-15-034	250-67-030	REP	92-03-002
246-975-080	REP-P	92-15-034	246-976-470	NEW-P	92-15-034	250-67-040	REP	92-03-002
246-975-090	REP-P	92-15-034	246-976-475	NEW-P	92-15-034	250-67-050	REP	92-03-002
246-975-100	REP-P	92-15-034	246-976-480	NEW-P	92-15-034	250-67-060	REP	92-03-002
246-975-110	REP-P	92-15-034	246-976-500	NEW-P	92-15-034	250-68-001	REP	92-03-002
246-975-120	REP-P	92-15-034	246-976-510	NEW-P	92-15-034	250-68-010	REP	92-03-002
246-975-130	REP-P	92-15-034	246-976-520	NEW-P	92-15-034	250-68-020	REP	92-03-002
246-975-140	REP-P	92-15-034	246-976-550	NEW-P	92-15-034	250-68-030	REP	92-03-002
246-975-150	REP-P	92-15-034	246-976-560	NEW-P	92-15-034	250-68-035	REP	92-03-002
246-975-160	REP-P	92-15-034	246-976-570	NEW-P	92-15-034	250-68-040	REP	92-03-002
246-975-170	REP-P	92-15-034	246-976-600	NEW-P	92-15-034	250-68-050	REP	92-03-002
246-975-180	REP-P	92-15-034	246-976-610	NEW-P	92-15-034	250-68-060	REP	92-03-002
246-975-190	REP-P	92-15-034	246-976-640	NEW-P	92-15-034	250-68-070	REP	92-03-002
246-975-200	REP-P	92-15-034	246-976-650	NEW-P	92-15-034	250-75-010	REP	92-03-002
246-975-210	REP-P	92-15-034	246-976-680	NEW-P	92-15-034	250-75-020	REP	92-03-002
246-975-220	REP-P	92-15-034	246-976-690	NEW-P	92-15-034	250-75-030	REP	92-03-002
246-975-230	REP-P	92-15-034	246-976-720	NEW-P	92-15-034	250-75-040	REP	92-03-002
246-975-240	REP-P	92-15-034	246-976-730	NEW-P	92-15-034	250-75-050	REP	92-03-002
246-975-250	REP-P	92-15-034	246-976-740	NEW-P	92-15-034	250-75-060	REP	92-03-002
246-975-260	REP-P	92-15-034	246-976-770	NEW-P	92-15-034	250-75-070	REP	92-03-002
246-975-270	REP-P	92-15-034	246-976-780	NEW-P	92-15-034	250-75-080	REP	92-03-002
246-975-280	REP-P	92-15-034	246-976-790	NEW-P	92-15-034	250-76-010	NEW	92-04-018
246-975-290	REP-P	92-15-034	246-976-810	NEW-P	92-15-034	250-76-020	NEW	92-04-018
246-975-300	REP-P	92-15-034	246-976-820	NEW-P	92-15-034	250-76-030	NEW	92-04-018
246-975-310	REP-P	92-15-034	246-976-880	NEW-P	92-15-034	250-76-040	NEW	92-04-018
246-975-320	REP-P	92-15-034	246-976-885	NEW-P	92-15-034	250-76-050	NEW	92-04-018
246-975-330	REP-P	92-15-034	246-976-890	NEW-P	92-15-034	250-76-060	NEW	92-04-018
246-975-340	REP-P	92-15-034	246-976-910	NEW-P	92-15-034	250-76-070	NEW	92-04-018
246-975-350	REP-P	92-15-034	246-976-920	NEW-P	92-15-034	250-78-010	AMD-P	92-13-077
246-975-360	REP-P	92-15-034	246-976-930	NEW-P	92-15-034	250-78-010	AMD-C	92-15-136
246-975-990	REP-P	92-15-034	246-976-940	NEW-P	92-15-034	250-78-020	AMD-P	92-13-077
246-976-001	NEW-P	92-15-034	246-976-950	NEW-P	92-15-034	250-78-020	AMD-C	92-15-136
246-976-010	NEW-P	92-15-034	246-976-960	NEW-P	92-15-034	250-78-030	AMD-P	92-13-077
246-976-020	NEW-P	92-15-034	246-976-970	NEW-P	92-15-034	250-78-030	AMD-C	92-15-136
246-976-025	NEW-P	92-15-034	246-976-990	NEW-P	92-15-034	250-78-050	AMD-P	92-13-077
246-976-030	NEW-P	92-15-034	246-977-001	REP-P	92-15-034	250-78-050	AMD-C	92-15-136
246-976-035	NEW-P	92-15-034	246-977-010	REP-P	92-15-034	250-78-060	AMD-P	92-13-077
246-976-040	NEW-P	92-15-034	246-977-020	REP-P	92-15-034	250-78-060	AMD-C	92-15-136
246-976-050	NEW-P	92-15-034	246-977-030	REP-P	92-15-034	251-01-010	REP	92-05-034
246-976-055	NEW-P	92-15-034	246-977-040	REP-P	92-15-034	251-01-075	AMD-C	92-05-026
246-976-060	NEW-P	92-15-034	246-977-050	REP-P	92-15-034	251-01-075	AMD-W	92-07-018
246-976-065	NEW-P	92-15-034	246-977-060	REP-P	92-15-034	251-01-075	AMD-P	92-09-120

### Table of WAC Sections Affected

WAC #	WSR #	WAC #	WSR #	WAC #	WSR #
251-01-075	AMD-W 92-13-008	251-17-190	AMD-W 92-07-018	284-16-310	NEW-P 92-15-102
251-01-120	AMD-C 92-05-026	251-17-200	AMD-W 92-07-018	284-16-320	NEW-P 92-15-102
251-01-120	AMD-W 92-07-018	251-17-200	AMD-P 92-09-122	284-16-400	NEW-P 92-15-103
251-01-120	AMD-P 92-09-120	251-17-200	AMD-W 92-13-008	284-16-410	NEW-P 92-15-103
251-01-120	AMD-W 92-13-008	251-18-180	AMD 92-05-034	284-16-420	NEW-P 92-15-103
251-01-145	AMD-C 92-05-026	251-22-215	REP-W 92-05-025	284-16-430	NEW-P 92-15-103
251-01-145	AMD-W 92-07-018	260-13-100	AMD-P 92-12-067	284-16-440	NEW-P 92-15-103
251-01-147	NEW-C 92-05-026	260-13-100	AMD-C 92-13-088	284-16-450	NEW-P 92-15-103
251-01-147	NEW-W 92-07-018	260-13-175	NEW-P 92-12-066	284-16-460	NEW-P 92-15-103
251-01-147	NEW-P 92-09-120	260-13-175	NEW-C 92-13-087	284-16-470	NEW-P 92-15-103
251-01-147	NEW-W 92-13-008	260-13-370	AMD-P 92-12-067	284-16-480	NEW-P 92-15-103
251-01-150	AMD-C 92-05-026	260-13-370	AMD-C 92-13-088	284-16-490	NEW-P 92-15-103
251-01-150	AMD-W 92-07-018	260-13-390	AMD-P 92-12-067	284-16-500	NEW-P 92-15-103
251-01-155	REP 92-05-034	260-13-390	AMD-C 92-13-088	284-16-510	NEW-P 92-15-103
251-01-210	AMD-C 92-05-026	260-13-400	AMD-P 92-12-067	284-16-520	NEW-P 92-15-103
251-01-210	AMD-W 92-07-018	260-13-400	AMD-C 92-13-088	284-16-530	NEW-P 92-15-103
251-01-255	AMD-W 92-03-079	260-24-280	AMD-P 92-12-068	284-16-540	NEW-P 92-15-103
251-01-255	AMD-P 92-05-072	260-24-280	AMD-C 92-13-089	284-22-010	NEW-E 92-14-085
251-01-255	AMD-W 92-07-019	260-32-400	AMD-P 92-15-097	284-22-020	NEW-E 92-14-085
251-01-320	REP 92-05-034	260-56-065	NEW-P 92-12-066	284-22-030	NEW-E 92-14-085
251-01-350	AMD-C 92-05-026	260-56-065	NEW-C 92-13-087	284-22-040	NEW-E 92-14-085
251-01-350	AMD-W 92-07-018	260-88-010	AMD-P 92-12-068	284-22-050	NEW-E 92-14-085
251-01-350	AMD-P 92-09-120	260-88-010	AMD-C 92-13-089	284-22-060	NEW-E 92-14-085
251-01-350	AMD-W 92-13-008	275-16-030	AMD-P 92-06-043	284-22-070	NEW-E 92-14-085
251-01-385	REP-C 92-05-026	275-16-030	AMD-E 92-06-044	284-22-080	NEW-E 92-14-085
251-01-385	REP-W 92-07-018	275-16-030	AMD 92-09-118	284-22-090	NEW-E 92-14-085
251-01-390	AMD-C 92-05-026	275-16-030	AMD-P 92-14-077	284-44	PREP 92-14-129
251-01-390	AMD-W 92-07-018	275-16-030	AMD-E 92-14-080	284-44-046	NEW-P 92-13-013
251-01-395	AMD-W 92-03-079	275-25-020	AMD-P 92-06-059	284-44-240	NEW-P 92-06-056
251-01-395	AMD-P 92-05-073	275-25-020	AMD 92-09-115	284-44-240	NEW 92-09-044
251-01-395	AMD-W 92-07-019	275-25-530	AMD-P 92-09-045	284-46	PREP 92-14-129
251-01-410	AMD-C 92-05-026	275-25-530	AMD-E 92-09-046	284-46-575	NEW-P 92-06-055
251-01-410	AMD-W 92-07-018	275-25-530	RESCIND 92-09-051	284-46-575	NEW 92-09-044A
251-04-060	AMD-P 92-09-123	275-25-530	AMD 92-13-032	284-50	PREP 92-14-129
251-04-060	AMD-W 92-13-055	275-27-020	AMD-P 92-06-059	284-50-270	NEW-P 92-13-014
251-04-060	AMD-P 92-13-061	275-27-020	AMD 92-09-115	284-50-270	NEW-W 92-13-086
251-04-060	AMD-C 92-14-113	275-27-026	AMD 92-04-004	284-52	PREP 92-14-129
251-09-025	AMD 92-05-034	275-27-219	NEW-P 92-09-113	284-58	PREP 92-14-129
251-09-030	AMD 92-05-034	275-27-219	NEW-E 92-09-119	284-60	PREP 92-14-129
251-09-071	NEW-P 92-05-075	275-27-219	NEW 92-13-024	284-66-010	AMD 92-06-021
251-09-071	NEW-W 92-07-019	275-27-220	AMD-P 92-05-076	284-66-020	AMD 92-06-021
251-10-030	AMD-C 92-05-027	275-27-220	AMD-E 92-05-077	284-66-030	AMD 92-06-021
251-10-030	AMD-W 92-07-018	275-27-220	AMD 92-09-114	284-66-040	AMD 92-06-021
251-10-030	AMD-P 92-09-121	275-27-223	AMD-P 92-05-076	284-66-050	AMD 92-06-021
251-10-030	AMD-W 92-13-008	275-27-223	AMD-E 92-05-077	284-66-060	AMD 92-06-021
251-10-030	AMD-C 92-05-028	275-27-223	AMD 92-09-114	284-66-063	NEW 92-06-021
251-12-072	AMD-W 92-07-018	275-56-005	AMD-P 92-07-033	284-66-066	NEW 92-06-021
251-12-072	AMD-P 92-09-126	275-56-005	AMD-E 92-07-034	284-66-066	AMD-P 92-14-130
251-12-072	AMD-W 92-13-008	275-56-005	AMD 92-11-055	284-66-070	REP 92-06-021
251-12-090	REP-P 92-09-124	275-56-015	AMD-P 92-07-033	284-66-073	NEW 92-06-021
251-12-090	REP 92-13-063	275-56-015	AMD-E 92-07-034	284-66-077	NEW 92-06-021
251-12-290	AMD-P 92-09-125	275-56-015	AMD 92-11-055	284-66-080	AMD 92-06-021
251-12-290	AMD-C 92-13-062	275-56-088	AMD-P 92-07-033	284-66-090	REP 92-06-021
251-12-290	AMD-C 92-14-114	275-56-088	AMD-E 92-07-034	284-66-092	NEW 92-06-021
251-17	AMD-C 92-05-029	275-56-088	AMD 92-11-055	284-66-092	AMD-P 92-14-130
251-17-010	AMD-W 92-07-018	275-56-447	NEW-E 92-07-034	284-66-100	REP 92-06-021
251-17-040	AMD-W 92-07-018	275-56-447	NEW 92-11-055	284-66-110	AMD 92-06-021
251-17-040	AMD-P 92-09-122	275-156-010	AMD-P 92-15-008	284-66-120	AMD 92-06-021
251-17-040	AMD-W 92-13-008	284-07-050	AMD-P 92-15-008	284-66-130	AMD 92-06-021
251-17-060	AMD-W 92-07-018	284-07-100	NEW-P 92-15-104	284-66-140	REP 92-06-021
251-17-060	AMD-P 92-09-122	284-07-100	NEW-P 92-15-104	284-66-142	NEW 92-06-021
251-17-060	AMD-W 92-13-008	284-07-110	NEW-P 92-15-104	284-66-150	REP 92-06-021
251-17-070	AMD-W 92-07-018	284-07-120	NEW-P 92-15-104	284-66-160	AMD 92-06-021
251-17-070	AMD-P 92-09-122	284-07-130	NEW-P 92-15-104	284-66-170	AMD 92-06-021
251-17-070	AMD-W 92-13-008	284-07-140	NEW-P 92-15-104	284-66-180	REP 92-06-021
251-17-090	AMD-W 92-07-018	284-07-150	NEW-P 92-15-104	284-66-190	REP 92-06-021
251-17-110	AMD-W 92-07-018	284-07-160	NEW-P 92-15-104	284-66-200	AMD 92-06-021
251-17-120	AMD-W 92-07-018	284-07-170	NEW-P 92-15-104	284-66-203	NEW 92-06-021
251-17-160	AMD-W 92-07-018	284-07-180	NEW-P 92-15-104	284-66-210	AMD 92-06-021
251-17-160	AMD-P 92-09-122	284-07-190	NEW-P 92-15-104	284-66-220	AMD 92-06-021
251-17-160	AMD-W 92-13-008	284-07-200	NEW-P 92-15-104	284-66-220	AMD-P 92-14-130
251-17-165	NEW-W 92-07-018	284-07-210	NEW-P 92-15-104	284-66-230	REP 92-06-021
251-17-165	NEW-P 92-09-122	284-07-220	NEW-P 92-15-104	284-66-232	NEW 92-06-021
251-17-165	NEW-W 92-13-008	284-07-230	NEW-P 92-15-104	284-66-240	AMD 92-06-021
251-17-170	AMD-W 92-07-018	284-16-050	REP-P 92-15-101	284-66-243	NEW 92-06-021
251-17-170	AMD-P 92-09-122	284-16-060	REP-P 92-15-103	284-66-250	AMD 92-06-021
251-17-170	AMD-W 92-13-008	284-16-300	NEW-P 92-15-102	284-66-260	AMD 92-06-021

Table of WAC Sections Affected

WAC #	WSR #	WAC #	WSR #	WAC #	WSR #			
284-66-270	AMD	92-06-021	296-56-60109	AMD-P	92-15-147	296-125-012	NEW-C	92-15-100
284-66-300	AMD	92-06-021	296-56-60115	AMD-P	92-15-147	296-125-015	AMD-P	92-12-093
284-66-310	AMD	92-06-021	296-56-60123	AMD-P	92-15-147	296-125-015	AMD-C	92-15-100
284-66-320	AMD	92-06-021	296-56-60131	AMD-P	92-15-147	296-125-020	AMD-P	92-12-093
284-66-323	NEW	92-06-021	296-56-60209	AMD-P	92-15-147	296-125-020	AMD-C	92-15-100
284-66-330	AMD	92-06-021	296-56-60215	AMD-P	92-15-147	296-125-023	REP-P	92-12-093
284-66-340	AMD	92-06-021	296-56-60223	AMD-P	92-15-147	296-125-023	REP-C	92-15-100
284-66-350	AMD	92-06-021	296-56-60229	AMD-P	92-15-147	296-125-024	NEW-P	92-12-093
284-66-400	AMD	92-06-021	296-56-60235	AMD-P	92-15-147	296-125-024	NEW-C	92-15-100
296-14-015	NEW	92-03-053	296-56-60237	AMD-P	92-15-147	296-125-026	NEW-P	92-12-093
296-17-45004	NEW-P	92-13-091	296-56-60239	AMD-P	92-15-147	296-125-026	NEW-C	92-15-100
296-17-66002	REP-W	92-06-034	296-62	PREP	92-03-135	296-125-027	AMD-P	92-12-093
296-17-66002	AMD-P	92-13-091	296-62-08001	NEW-P	92-03-137	296-125-027	AMD-C	92-15-100
296-17-66003	NEW-W	92-06-034	296-62-08001	NEW	92-08-100	296-125-028	NEW-P	92-12-093
296-17-885	AMD-W	92-06-034	296-62-08050	NEW-P	92-03-137	296-125-028	NEW-C	92-15-100
296-17-895	AMD-W	92-06-034	296-62-08050	NEW	92-08-100	296-125-030	AMD-P	92-12-093
296-18A-460	AMD-P	92-14-116	296-62-09005	AMD-P	92-15-147	296-125-030	AMD-C	92-15-100
296-18A-465	REP-P	92-14-116	296-67-001	NEW-P	92-12-087	296-125-033	AMD-P	92-12-093
296-20-01002	AMD	92-05-041	296-67-005	NEW-P	92-12-087	296-125-033	AMD-C	92-15-100
296-20-030	AMD-E	92-07-100	296-67-009	NEW-P	92-12-087	296-125-050	AMD-P	92-12-093
296-20-030	RECSIND	92-08-097	296-67-013	NEW-P	92-12-087	296-125-050	AMD-C	92-15-100
296-20-03001	AMD-E	92-07-100	296-67-017	NEW-P	92-12-087	296-125-055	REP-P	92-12-093
296-20-03001	RECSIND	92-08-097	296-67-021	NEW-P	92-12-087	296-125-055	REP-C	92-15-100
296-20-091	AMD	92-05-041	296-67-025	NEW-P	92-12-087	296-125-060	AMD-P	92-12-093
296-23-50001	AMD	92-05-041	296-67-029	NEW-P	92-12-087	296-125-060	AMD-C	92-15-100
296-23-610	AMD-E	92-07-100	296-67-033	NEW-P	92-12-087	296-125-110	REP-P	92-12-093
296-23-610	RESCIND	92-08-097	296-67-037	NEW-P	92-12-087	296-125-110	REP-C	92-15-100
296-24-11001	AMD-P	92-15-147	296-67-041	NEW-P	92-12-087	296-125-115	REP-P	92-12-093
296-24-11003	AMD-P	92-15-147	296-67-045	NEW-P	92-12-087	296-125-115	REP-C	92-15-100
296-24-11005	AMD-P	92-15-147	296-67-049	NEW-P	92-12-087	296-125-120	REP-P	92-12-093
296-24-11007	AMD-P	92-15-147	296-67-053	NEW-P	92-12-087	296-125-120	REP-C	92-15-100
296-24-11009	AMD-P	92-15-147	296-67-057	NEW-P	92-12-087	296-125-125	REP-P	92-12-093
296-24-11011	AMD-P	92-15-147	296-67-061	NEW-P	92-12-087	296-125-125	REP-C	92-15-100
296-24-11013	AMD-P	92-15-147	296-67-285	NEW-P	92-12-087	296-125-130	REP-P	92-12-093
296-24-11015	AMD-P	92-15-147	296-67-289	NEW-P	92-12-087	296-125-130	REP-C	92-15-100
296-24-11017	AMD-P	92-15-147	296-67-291	NEW-P	92-12-087	296-125-135	REP-P	92-12-093
296-24-119	AMD-P	92-15-147	296-67-293	NEW-P	92-12-087	296-125-135	REP-C	92-15-100
296-24-19517	AMD-P	92-12-087	296-104-010	AMD-P	92-08-087	296-125-140	REP-P	92-12-093
296-24-20700	AMD-P	92-12-087	296-104-010	AMD	92-11-070	296-125-140	REP-C	92-15-100
296-24-20730	AMD-P	92-12-087	296-104-018	NEW-P	92-08-087	296-125-145	REP-P	92-12-093
296-24-76555	AMD-P	92-12-087	296-104-018	NEW	92-11-070	296-125-145	REP-C	92-15-100
296-30-081	AMD-E	92-09-149	296-104-200	AMD-P	92-08-087	296-125-155	REP-P	92-12-093
296-30-081	AMD-P	92-11-071	296-104-200	AMD	92-11-070	296-125-155	REP-C	92-15-100
296-37-510	AMD-P	92-15-147	296-104-500	AMD-P	92-08-087	296-125-160	REP-P	92-12-093
296-37-515	AMD-P	92-15-147	296-104-500	AMD	92-11-070	296-125-160	REP-C	92-15-100
296-37-550	AMD-P	92-15-147	296-104-501	AMD-P	92-08-087	296-125-165	REP-P	92-12-093
296-37-560	AMD-P	92-15-147	296-104-501	AMD	92-11-070	296-125-165	REP-C	92-15-100
296-37-565	AMD-P	92-15-147	296-104-530	AMD-P	92-08-087	296-125-170	REP-P	92-12-093
296-37-570	AMD-P	92-15-147	296-104-530	AMD	92-11-070	296-125-170	REP-C	92-15-100
296-37-575	AMD-P	92-15-147	296-116-075	PREP	92-07-075	296-125-175	REP-P	92-12-093
296-37-580	AMD-P	92-15-147	296-116-075	AMD-P	92-12-079	296-125-175	REP-C	92-15-100
296-37-585	AMD-P	92-15-147	296-116-075	AMD	92-15-064	296-127-018	NEW	92-08-101
296-37-590	NEW-P	92-15-147	296-116-080	AMD-P	92-08-049	296-131-006	NEW-P	92-10-078
296-46-910	AMD-P	92-03-136	296-116-080	AMD-E	92-08-053	296-131-006	NEW	92-15-099
296-46-910	AMD	92-08-102	296-116-080	AMD	92-14-070	296-131-120	AMD-P	92-10-078
296-46-910	AMD-E	92-08-103	296-116-082	AMD-P	92-04-075	296-131-120	AMD	92-15-099
296-46-915	AMD-P	92-03-136	296-116-082	AMD	92-08-051	296-131-130	AMD-P	92-10-078
296-46-915	AMD	92-08-102	296-116-082	AMD-E	92-08-054	296-131-130	AMD	92-15-099
296-46-915	AMD-E	92-08-103	296-116-110	AMD-E	92-03-108	296-155-110	AMD-P	92-03-137
296-52-401	AMD-P	92-12-087	296-116-110	AMD-P	92-04-073	296-155-110	AMD-C	92-08-099
296-52-461	AMD-P	92-12-087	296-116-110	AMD	92-08-050	296-155-110	AMD	92-09-148
296-52-489	AMD-P	92-12-087	296-116-185	AMD-P	92-08-048	296-155-48527	AMD-P	92-12-087
296-52-493	AMD-P	92-12-087	296-116-185	AMD-C	92-11-035	296-155-48529	AMD-P	92-12-087
296-56-60001	AMD-P	92-15-147	296-116-185	AMD	92-14-069	296-155-48531	AMD-P	92-12-087
296-56-60005	AMD-P	92-15-147	296-116-2051	AMD-P	92-04-074	296-155-48536	AMD-P	92-15-147
296-56-60007	AMD-P	92-15-147	296-116-2051	AMD	92-08-050	296-155-650	AMD-P	92-15-147
296-56-60041	AMD-P	92-15-147	296-116-300	AMD-P	92-07-076	296-155-655	AMD-P	92-15-147
296-56-60043	AMD-P	92-15-147	296-116-300	AMD	92-14-007	296-155-657	AMD-P	92-15-147
296-56-60053	AMD-P	92-15-147	296-116-300	AMD-E	92-14-008	296-155-66103	AMD-P	92-15-147
296-56-60057	AMD-P	92-15-147	296-125	AMD-P	92-12-093	296-155-66105	AMD-P	92-15-147
296-56-60073	AMD-P	92-15-147	296-125	AMD-C	92-14-115	296-155-66109	AMD-P	92-15-147
296-56-60079	AMD-P	92-15-147	296-125	AMD-C	92-15-100	296-155-664	AMD-P	92-15-147
296-56-60083	AMD-P	92-15-147	296-125-010	AMD-P	92-12-093	296-155-66401	NEW-P	92-15-147
296-56-60085	AMD-P	92-15-147	296-125-010	AMD-C	92-15-100	296-155-66403	NEW-P	92-15-147
296-56-60091	AMD-P	92-15-147	296-125-011	NEW-P	92-12-093	296-155-66405	NEW-P	92-15-147
296-56-60103	AMD-P	92-15-147	296-125-011	NEW-C	92-15-100	296-155-66407	NEW-P	92-15-147
296-56-60107	AMD-P	92-15-147	296-125-012	NEW-P	92-12-093	296-155-66409	NEW-P	92-15-147

**Table of WAC Sections Affected**

WAC #	WSR #	WAC #	WSR #	WAC #	WSR #			
296-155-66411	NEW-P	92-15-147	308-20-100	AMD	92-04-006	308-58-020	AMD-P	92-11-047
296-155-694	AMD-P	92-15-147	308-20-105	AMD	92-04-006	308-58-020	AMD	92-15-022
296-306	PREP	92-08-098	308-20-107	AMD	92-04-006	308-58-040	AMD-P	92-11-047
296-306	PREP	92-11-072	308-20-109	AMD	92-04-006	308-58-040	AMD	92-15-022
296-401-175	AMD-P	92-03-136	308-20-110	AMD	92-04-006	308-89-020	AMD-P	92-09-145
296-401-175	AMD	92-09-010	308-20-120	AMD	92-04-006	308-89-020	AMD	92-12-036
296-401-175	AMD-E	92-09-011	308-20-130	AMD	92-04-006	308-89-040	AMD-P	92-09-145
304-12-030	AMD-P	92-04-076	308-20-140	AMD	92-04-006	308-89-040	AMD	92-12-036
304-12-030	AMD	92-08-023	308-20-150	AMD	92-04-006	308-89-050	AMD-P	92-09-145
306-01-010	NEW-P	92-11-064	308-20-155	AMD	92-04-006	308-89-050	AMD	92-12-036
306-01-010	NEW	92-15-018	308-20-171	AMD	92-04-006	308-89-060	NEW-P	92-09-145
306-01-020	NEW-P	92-11-064	308-20-172	NEW	92-04-006	308-89-060	NEW	92-12-036
306-01-020	NEW	92-15-018	308-20-175	AMD	92-04-006	308-90-150	AMD	92-06-009
306-01-030	NEW-P	92-11-064	308-20-180	AMD	92-04-006	308-93-050	AMD	92-03-075
306-01-030	NEW	92-15-018	308-20-205	AMD	92-04-006	308-93-070	AMD	92-03-075
306-01-040	NEW-P	92-11-064	308-20-208	NEW	92-04-006	308-93-241	NEW-P	92-11-046
306-01-040	NEW	92-15-018	308-20-210	AMD	92-04-006	308-93-241	NEW	92-15-023
306-01-050	NEW-P	92-11-064	308-20-210	AMD-P	92-10-079	308-93-242	NEW-P	92-11-046
306-01-050	NEW	92-15-018	308-20-210	AMD	92-15-087	308-93-242	NEW	92-15-023
306-01-060	NEW-P	92-11-064	308-20-310	NEW-P	92-10-079	308-93-243	NEW-P	92-11-046
306-01-060	NEW	92-15-018	308-20-310	NEW	92-15-087	308-93-243	NEW	92-15-023
306-01-070	NEW-P	92-11-064	308-20-500	NEW-P	92-10-079	308-93-244	NEW-P	92-11-046
306-01-070	NEW	92-15-018	308-20-500	NEW	92-15-087	308-93-244	NEW	92-15-023
306-01-080	NEW-P	92-11-064	308-20-510	NEW-P	92-10-079	308-93-245	NEW-P	92-11-046
306-01-080	NEW	92-15-018	308-20-510	NEW	92-15-087	308-93-245	NEW	92-15-023
308-10-005	AMD-P	92-05-088	308-20-520	NEW-P	92-10-079	308-93-290	AMD	92-03-075
308-10-005	AMD	92-09-107	308-20-520	NEW	92-15-087	308-93-295	AMD	92-06-009
308-10-010	AMD-P	92-05-088	308-20-530	NEW-P	92-10-079	308-94-030	AMD-P	92-11-049
308-10-010	AMD	92-09-107	308-20-530	NEW	92-15-087	308-94-030	AMD	92-15-021
308-10-015	AMD-P	92-05-088	308-20-540	NEW-P	92-10-079	308-94-080	AMD-P	92-11-049
308-10-015	AMD	92-09-107	308-20-540	NEW	92-15-087	308-94-080	AMD	92-15-021
308-10-020	AMD-P	92-05-088	308-20-545	NEW-P	92-10-079	308-94-200	AMD-P	92-11-049
308-10-020	AMD	92-09-107	308-20-545	NEW	92-15-087	308-94-200	AMD	92-15-021
308-10-025	AMD-P	92-05-088	308-20-550	NEW-P	92-10-079	308-96A-005	AMD	92-02-100
308-10-025	AMD	92-09-107	308-20-550	NEW	92-15-087	308-96A-005	AMD-P	92-11-050
308-10-030	AMD-P	92-05-088	308-20-560	NEW-P	92-10-079	308-96A-005	AMD	92-15-025
308-10-030	AMD	92-09-107	308-20-560	NEW	92-15-087	308-96A-026	AMD-P	92-11-050
308-10-040	AMD-P	92-05-088	308-20-570	NEW-P	92-10-079	308-96A-026	AMD	92-15-025
308-10-040	AMD	92-09-107	308-20-570	NEW	92-15-087	308-96A-035	AMD-P	92-11-050
308-10-045	AMD-P	92-05-088	308-20-590	NEW-P	92-10-079	308-96A-035	AMD	92-15-025
308-10-045	AMD	92-09-107	308-20-590	NEW	92-15-087	308-96A-040	AMD	92-02-100
308-10-050	AMD-P	92-05-088	308-20-600	NEW-P	92-10-079	308-96A-046	AMD	92-02-100
308-10-050	AMD	92-09-107	308-20-600	NEW	92-15-087	308-96A-100	AMD	92-03-076
308-10-055	AMD-P	92-05-088	308-20-610	NEW-P	92-10-079	308-96A-136	AMD	92-02-100
308-10-055	AMD	92-09-107	308-20-610	NEW	92-15-087	308-96A-161	AMD-P	92-11-050
308-10-060	AMD-P	92-05-088	308-20-630	NEW-P	92-10-079	308-96A-161	AMD	92-15-025
308-10-060	AMD	92-09-107	308-20-630	NEW	92-15-087	308-96A-162	AMD-P	92-11-050
308-10-070	AMD-P	92-05-088	308-20-640	NEW-P	92-10-079	308-96A-162	AMD	92-15-025
308-10-070	AMD	92-09-107	308-20-640	NEW	92-15-087	308-96A-201	NEW	92-02-100
308-11-100	AMD-P	92-09-097	308-20-670	NEW-P	92-10-079	308-96A-205	AMD	92-02-100
308-11-100	AMD	92-13-045	308-20-670	NEW	92-15-087	308-96A-206	NEW	92-02-100
308-11-130	NEW-P	92-09-097	308-20-680	NEW-P	92-10-079	308-96A-207	NEW	92-02-100
308-11-130	NEW	92-13-045	308-20-680	NEW	92-15-087	308-96A-208	NEW	92-02-100
308-13-032	AMD-P	92-05-013	308-20-690	NEW-P	92-10-079	308-96A-210	AMD	92-02-100
308-13-032	AMD	92-10-030	308-20-690	NEW	92-15-087	308-96A-220	AMD	92-02-100
308-13-040	AMD-P	92-05-013	308-20-700	NEW-P	92-10-079	308-96A-260	AMD	92-02-100
308-13-040	AMD	92-10-030	308-20-700	NEW	92-15-087	308-96A-275	AMD	92-02-100
308-13-041	REP-P	92-05-013	308-56A-010	AMD-P	92-11-048	308-96A-275	AMD-P	92-11-050
308-13-041	REP	92-10-030	308-56A-010	AMD	92-15-024	308-96A-275	AMD	92-15-025
308-13-042	REP-P	92-05-013	308-56A-040	AMD-P	92-11-048	308-96A-300	AMD	92-02-100
308-13-042	REP	92-10-030	308-56A-040	AMD	92-15-024	308-96A-306	AMD	92-03-076
308-20	AMD	92-04-006	308-56A-140	AMD	92-03-077	308-96A-310	AMD	92-03-076
308-20-001	NEW-P	92-10-079	308-56A-250	AMD-P	92-11-048	308-96A-315	AMD	92-03-076
308-20-001	NEW	92-15-087	308-56A-250	AMD	92-15-024	308-96A-320	AMD	92-03-076
308-20-005	NEW-P	92-10-079	308-56A-260	REP-P	92-11-048	308-96A-325	AMD	92-03-076
308-20-005	NEW	92-15-087	308-56A-260	REP	92-15-024	308-96A-330	AMD	92-03-076
308-20-010	AMD	92-04-006	308-56A-450	AMD-P	92-11-048	308-96A-335	AMD	92-03-076
308-20-020	AMD	92-04-006	308-56A-450	AMD	92-15-024	308-96A-340	NEW	92-03-076
308-20-030	AMD	92-04-006	308-56A-455	AMD-P	92-11-048	308-102-002	NEW-P	92-05-061
308-20-040	AMD	92-04-006	308-56A-455	AMD	92-15-024	308-102-002	NEW	92-08-045
308-20-045	NEW-P	92-10-079	308-56A-460	AMD-P	92-11-048	308-102-004	NEW-P	92-05-061
308-20-045	NEW	92-15-087	308-56A-460	AMD	92-15-024	308-102-004	NEW	92-08-045
308-20-050	AMD	92-04-006	308-56A-465	AMD-P	92-11-048	308-102-006	NEW-P	92-05-061
308-20-060	AMD	92-04-006	308-56A-465	AMD	92-15-024	308-102-006	NEW	92-08-045
308-20-070	AMD	92-04-006	308-56A-470	NEW	92-03-077	308-102-008	NEW-P	92-05-061
308-20-080	AMD	92-04-006	308-57-230	AMD-P	92-11-048	308-102-008	NEW	92-08-045
308-20-090	AMD	92-04-006	308-57-230	AMD	92-15-024	308-102-010	AMD-P	92-05-061

**Table of WAC Sections Affected**

WAC #		WSR #	WAC #		WSR #	WAC #		WSR #
308-102-010	AMD	92-08-045	308-300-270	AMD	92-10-010	315-11-820	NEW-P	92-12-091
308-102-011	AMD-P	92-05-061	308-300-280	AMD-P	92-07-095	315-11-820	NEW	92-15-082
308-102-011	AMD	92-08-045	308-300-280	AMD	92-10-010	315-11-821	NEW-P	92-12-091
308-102-020	AMD-P	92-05-061	314-12-015	NEW-P	92-08-085	315-11-821	NEW	92-15-082
308-102-020	AMD	92-08-045	314-12-015	NEW	92-14-024	315-11-822	NEW-P	92-12-091
308-102-040	REP-P	92-05-061	314-12-090	REP-P	92-08-084	315-11-822	NEW	92-15-082
308-102-040	REP	92-08-045	314-12-090	REP	92-14-023	315-11-830	NEW-P	92-12-091
308-102-100	AMD-P	92-05-061	314-16-190	AMD-P	92-08-086	315-11-830	NEW	92-15-082
308-102-100	AMD	92-08-045	314-16-190	AMD-W	92-14-022	315-11-831	NEW-P	92-12-091
308-102-110	REP-P	92-05-061	314-16-196	AMD-P	92-08-088	315-11-831	NEW	92-15-082
308-102-110	REP	92-08-045	314-16-196	AMD	92-14-025	315-11-832	NEW-P	92-12-091
308-102-120	REP-P	92-05-061	314-16-197	AMD-P	92-08-089	315-11-832	NEW	92-15-082
308-102-120	REP	92-08-045	314-16-197	AMD	92-14-026	315-11-840	NEW-P	92-12-091
308-102-125	REP-P	92-05-061	314-20-020	AMD	92-03-109	315-11-840	NEW	92-15-082
308-102-125	REP	92-08-045	314-20-070	AMD-P	92-09-143	315-11-841	NEW-P	92-12-091
308-102-130	AMD-P	92-05-061	314-20-070	AMD	92-14-028	315-11-841	NEW	92-15-082
308-102-130	AMD	92-08-045	314-24-040	AMD	92-03-110	315-11-842	NEW-P	92-12-091
308-102-140	AMD-P	92-05-061	314-60-040	AMD-P	92-09-142	315-11-842	NEW	92-15-082
308-102-140	AMD	92-08-045	314-60-040	AMD	92-14-027	315-11-850	NEW-P	92-12-091
308-102-150	REP-P	92-05-061	315-11-691	AMD	92-03-048	315-11-850	NEW	92-15-082
308-102-150	REP	92-08-045	315-11-710	NEW	92-03-048	315-11-851	NEW-P	92-12-091
308-102-160	REP-P	92-05-061	315-11-711	NEW	92-03-048	315-11-851	NEW	92-15-082
308-102-160	REP	92-08-045	315-11-712	NEW	92-03-048	315-11-852	NEW-P	92-12-091
308-102-170	REP-P	92-05-061	315-11-730	NEW	92-03-048	315-11-852	NEW	92-15-082
308-102-170	REP	92-08-045	315-11-731	NEW	92-03-048	315-30-020	AMD-P	92-08-093
308-102-180	REP-P	92-05-061	315-11-732	NEW	92-03-048	315-30-020	AMD	92-11-033
308-102-180	REP	92-08-045	315-11-740	NEW	92-03-048	315-30-030	AMD-P	92-08-093
308-102-190	AMD-P	92-05-061	315-11-741	NEW	92-03-048	315-30-030	AMD	92-11-033
308-102-190	AMD	92-08-045	315-11-742	NEW	92-03-048	315-30-040	AMD-P	92-08-093
308-102-200	AMD-P	92-05-061	315-11-750	NEW-P	92-03-146	315-30-040	AMD	92-11-033
308-102-200	AMD	92-08-045	315-11-750	NEW-W	92-05-069	315-31-060	AMD-P	92-08-093
308-102-210	REP-P	92-05-061	315-11-751	NEW-P	92-03-146	315-31-060	AMD-W	92-11-010
308-102-210	REP	92-08-045	315-11-751	NEW-W	92-05-069	315-31-060	AMD-P	92-12-091
308-102-220	REP-P	92-05-061	315-11-752	NEW-P	92-03-146	315-33A-010	AMD-P	92-08-093
308-102-220	REP	92-08-045	315-11-752	NEW-W	92-05-069	315-33A-010	AMD	92-11-033
308-102-230	REP-P	92-05-061	315-11-753	NEW	92-08-002	315-33A-020	AMD-P	92-08-093
308-102-230	REP	92-08-045	315-11-754	NEW	92-08-002	315-33A-020	AMD	92-11-033
308-102-240	REP-P	92-05-061	315-11-755	NEW	92-08-002	315-33A-060	AMD-P	92-12-091
308-102-240	REP	92-08-045	315-11-760	NEW-P	92-03-146	315-33A-060	AMD-W	92-15-083
308-102-250	AMD-P	92-05-061	315-11-760	NEW	92-08-002	315-33B-010	NEW-P	92-03-146
308-102-250	AMD	92-08-045	315-11-761	NEW-P	92-03-146	315-33B-010	NEW	92-08-002
308-102-255	NEW-P	92-05-061	315-11-761	NEW	92-08-002	315-33B-020	NEW-P	92-03-146
308-102-255	NEW	92-08-045	315-11-762	NEW-P	92-03-146	315-33B-020	NEW	92-08-002
308-102-260	AMD-P	92-05-061	315-11-762	NEW	92-08-002	315-33B-030	NEW-P	92-03-146
308-102-260	AMD	92-08-045	315-11-770	NEW-P	92-03-146	315-33B-030	NEW	92-08-002
308-102-265	AMD-P	92-05-061	315-11-770	NEW-P	92-08-093	315-33B-040	NEW-P	92-03-146
308-102-265	AMD	92-08-045	315-11-770	NEW	92-11-033	315-33B-040	NEW	92-08-002
308-102-270	REP-P	92-05-061	315-11-771	NEW-P	92-03-146	315-33B-050	NEW-P	92-03-146
308-102-270	REP	92-08-045	315-11-771	NEW-P	92-08-093	315-33B-050	NEW	92-08-002
308-102-280	REP-P	92-05-061	315-11-771	NEW	92-11-033	315-33B-060	NEW-P	92-03-146
308-102-280	REP	92-08-045	315-11-772	NEW-P	92-03-146	315-33B-060	NEW	92-08-002
308-102-290	AMD-P	92-05-061	315-11-772	NEW-P	92-08-093	315-33B-060	AMD-P	92-12-091
308-102-290	AMD	92-08-045	315-11-772	NEW	92-11-033	315-33B-060	AMD-W	92-15-083
308-102-295	REP-P	92-05-061	315-11-780	NEW-P	92-08-093	315-33B-070	NEW-P	92-03-146
308-102-295	REP	92-08-045	315-11-780	NEW	92-11-033	315-33B-070	NEW	92-08-002
308-104-160	AMD-P	92-05-061	315-11-781	NEW-P	92-08-093	315-34-010	AMD-P	92-08-093
308-104-160	AMD	92-08-045	315-11-781	NEW	92-11-033	315-34-010	AMD	92-11-033
308-104-340	NEW-P	92-05-061	315-11-782	NEW-P	92-08-093	315-34-020	AMD-P	92-08-093
308-104-340	NEW	92-08-045	315-11-782	NEW	92-11-033	315-34-020	AMD	92-11-033
308-125-010	AMD-P	92-14-084	315-11-790	NEW-P	92-08-093	315-34-040	AMD-P	92-03-146
308-125-020	AMD-P	92-14-084	315-11-790	NEW	92-11-033	315-34-040	AMD	92-07-014
308-125-030	AMD-P	92-14-084	315-11-791	NEW-P	92-08-093	315-34-040	AMD-P	92-08-093
308-125-070	AMD-P	92-14-084	315-11-791	NEW	92-11-033	315-34-040	AMD	92-11-033
308-125-080	AMD-P	92-14-084	315-11-792	NEW-P	92-08-093	315-40-010	NEW	92-03-048
308-125-085	NEW-P	92-14-084	315-11-792	NEW	92-11-033	315-40-020	NEW	92-03-048
308-125-100	AMD-P	92-14-084	315-11-800	NEW-P	92-08-093	315-40-030	NEW	92-03-048
308-125-120	AMD-P	92-14-084	315-11-800	NEW	92-11-033	315-40-040	NEW	92-03-048
308-125-130	AMD-P	92-14-084	315-11-801	NEW-P	92-08-093	315-40-050	NEW	92-03-048
308-300-220	AMD-P	92-07-095	315-11-801	NEW	92-11-033	315-40-060	NEW	92-03-048
308-300-220	AMD	92-10-010	315-11-802	NEW-P	92-08-093	315-40-070	NEW	92-03-048
308-300-230	AMD-P	92-07-095	315-11-802	NEW	92-11-033	315-40-080	NEW	92-03-048
308-300-230	AMD	92-10-010	315-11-810	NEW-P	92-12-091	315-41-50100	NEW	92-03-048
308-300-240	AMD-P	92-07-095	315-11-810	NEW	92-15-082	315-41-50110	NEW	92-03-048
308-300-240	AMD	92-10-010	315-11-811	NEW-P	92-12-091	315-41-50120	NEW	92-03-048
308-300-250	AMD-P	92-07-095	315-11-811	NEW	92-15-082	315-41-50200	NEW	92-03-048
308-300-250	AMD	92-10-010	315-11-812	NEW-P	92-12-091	315-41-50210	NEW	92-03-048
308-300-270	AMD-P	92-07-095	315-11-812	NEW	92-15-082	315-41-50220	NEW	92-03-048

Table of WAC Sections Affected

WAC #	WSR #	WAC #	WSR #	WAC #	WSR #			
315-41-50300	NEW	92-03-048	326-08-010	AMD	92-15-077	326-20-010	AMD-E	92-07-001
315-41-50310	NEW	92-03-048	326-08-015	AMD-E	92-07-001	326-20-010	RESCIND	92-07-102
315-41-50320	NEW	92-03-048	326-08-015	AMD-P	92-11-018	326-20-010	AMD-E	92-07-102
315-41-50400	NEW-P	92-03-146	326-08-015	AMD-E	92-11-019	326-20-010	AMD-P	92-07-103
315-41-50400	NEW	92-08-094	326-08-015	AMD	92-15-077	326-20-010	AMD	92-11-007
315-41-50410	NEW-P	92-03-146	326-08-016	NEW-E	92-07-001	326-20-020	REP-E	92-07-001
315-41-50410	NEW	92-08-094	326-08-016	NEW-P	92-11-018	326-20-020	RESCIND	92-07-102
315-41-50420	NEW-P	92-03-146	326-08-016	NEW-E	92-11-019	326-20-020	REP-E	92-07-102
315-41-50420	NEW	92-08-094	326-08-016	NEW	92-15-077	326-20-020	REP-P	92-07-103
315-41-50500	NEW-P	92-03-146	326-08-018	NEW-E	92-07-001	326-20-020	REP	92-11-007
315-41-50500	NEW	92-08-094	326-08-018	NEW-P	92-11-018	326-20-030	AMD-E	92-07-001
315-41-50510	NEW-P	92-03-146	326-08-018	NEW-E	92-11-019	326-20-030	RESCIND	92-07-102
315-41-50510	NEW	92-08-094	326-08-018	NEW	92-15-077	326-20-030	AMD-E	92-07-102
315-41-50520	NEW-P	92-03-146	326-08-020	AMD-E	92-07-001	326-20-030	AMD-P	92-07-103
315-41-50520	NEW	92-08-094	326-08-020	AMD-P	92-11-018	326-20-030	AMD	92-11-007
315-41-50600	NEW-P	92-03-146	326-08-020	AMD-E	92-11-019	326-20-040	AMD-E	92-07-001
315-41-50600	NEW	92-08-094	326-08-020	AMD	92-15-077	326-20-040	RESCIND	92-07-102
315-41-50610	NEW-P	92-03-146	326-08-035	NEW-E	92-07-001	326-20-040	AMD-E	92-07-102
315-41-50610	NEW	92-08-094	326-08-035	NEW-P	92-11-018	326-20-040	AMD-P	92-07-103
315-41-50620	NEW-P	92-03-146	326-08-035	NEW-E	92-11-019	326-20-040	AMD	92-11-007
315-41-50620	NEW	92-08-094	326-08-035	NEW	92-15-077	326-20-050	AMD-E	92-07-001
318-04-020	AMD-E	92-15-050	326-08-040	AMD-E	92-07-001	326-20-050	RESCIND	92-07-102
318-04-030	AMD	92-03-061	326-08-040	AMD-P	92-11-018	326-20-050	AMD-E	92-07-102
318-04-030	AMD-E	92-15-050	326-08-040	AMD-E	92-11-019	326-20-050	AMD-P	92-07-103
326-02-010	AMD-E	92-07-001	326-08-040	AMD	92-15-077	326-20-050	AMD	92-11-007
326-02-010	RESCIND	92-07-102	326-08-050	AMD-E	92-07-001	326-20-060	AMD-E	92-07-001
326-02-010	AMD-E	92-07-102	326-08-050	AMD-P	92-11-018	326-20-060	RESCIND	92-07-102
326-02-010	AMD-P	92-07-103	326-08-050	AMD-E	92-11-019	326-20-060	AMD-E	92-07-102
326-02-010	AMD	92-11-007	326-08-050	AMD	92-15-077	326-20-060	AMD-P	92-07-103
326-02-020	AMD-E	92-07-001	326-08-051	NEW-E	92-07-001	326-20-060	AMD	92-11-007
326-02-020	RESCIND	92-07-102	326-08-051	NEW-P	92-11-018	326-20-070	AMD-E	92-07-001
326-02-020	AMD-E	92-07-102	326-08-051	NEW-E	92-11-019	326-20-070	RESCIND	92-07-102
326-02-020	AMD-P	92-07-103	326-08-051	NEW	92-15-077	326-20-070	AMD-E	92-07-102
326-02-020	AMD	92-11-007	326-08-060	REP-E	92-07-001	326-20-070	AMD-P	92-07-103
326-02-030	AMD-E	92-07-001	326-08-060	REP-P	92-11-018	326-20-070	AMD	92-11-007
326-02-030	RESCIND	92-07-102	326-08-060	REP-E	92-11-019	326-20-080	AMD-E	92-07-001
326-02-030	AMD-E	92-07-102	326-08-060	REP	92-15-077	326-20-080	RESCIND	92-07-102
326-02-030	AMD-P	92-07-103	326-08-070	AMD-E	92-07-001	326-20-080	AMD-E	92-07-102
326-02-030	AMD	92-11-007	326-08-070	AMD-P	92-11-018	326-20-080	AMD-P	92-07-103
326-02-040	AMD-E	92-07-001	326-08-070	AMD-E	92-11-019	326-20-080	AMD	92-11-007
326-02-040	RESCIND	92-07-102	326-08-070	AMD	92-15-077	326-20-081	AMD-E	92-07-001
326-02-040	AMD-E	92-07-102	326-08-080	AMD-E	92-07-001	326-20-081	RESCIND	92-07-102
326-02-040	AMD-P	92-07-103	326-08-080	AMD-P	92-11-018	326-20-081	AMD-E	92-07-102
326-02-040	AMD	92-11-007	326-08-080	AMD-E	92-11-019	326-20-081	AMD-P	92-07-103
326-02-045	NEW-E	92-07-001	326-08-080	AMD	92-15-077	326-20-081	AMD	92-11-007
326-02-045	RESCIND	92-07-102	326-08-090	AMD-E	92-07-001	326-20-091	REP-E	92-07-001
326-02-045	NEW-E	92-07-102	326-08-090	AMD-P	92-11-018	326-20-091	RESCIND	92-07-102
326-02-045	NEW-P	92-07-103	326-08-090	AMD-E	92-11-019	326-20-091	REP-E	92-07-102
326-02-045	NEW	92-11-007	326-08-090	AMD	92-15-077	326-20-091	REP-P	92-07-103
326-02-050	AMD-E	92-07-001	326-08-095	AMD-E	92-07-001	326-20-091	REP	92-11-007
326-02-050	RESCIND	92-07-102	326-08-095	AMD-P	92-11-018	326-20-092	AMD-E	92-07-001
326-02-050	AMD-E	92-07-102	326-08-095	AMD-E	92-11-019	326-20-092	RESCIND	92-07-102
326-02-050	AMD-P	92-07-103	326-08-095	AMD	92-15-077	326-20-092	AMD-E	92-07-102
326-02-050	AMD	92-11-007	326-08-100	AMD-E	92-07-001	326-20-092	AMD-P	92-07-103
326-02-060	AMD-E	92-07-001	326-08-100	AMD-P	92-11-018	326-20-092	AMD	92-11-007
326-02-060	RESCIND	92-07-102	326-08-100	AMD-E	92-11-019	326-20-093	REP-E	92-07-001
326-02-060	AMD-E	92-07-102	326-08-100	AMD	92-15-077	326-20-093	RESCIND	92-07-102
326-02-060	AMD-P	92-07-103	326-08-105	NEW-E	92-07-001	326-20-093	REP-E	92-07-102
326-02-060	AMD	92-11-007	326-08-105	NEW-P	92-11-018	326-20-093	REP-P	92-07-103
326-02-070	AMD-E	92-07-001	326-08-105	NEW-E	92-11-019	326-20-093	REP	92-11-007
326-02-070	RESCIND	92-07-102	326-08-105	NEW	92-15-077	326-20-094	AMD-E	92-07-001
326-02-070	AMD-E	92-07-102	326-08-110	AMD-E	92-07-001	326-20-094	RESCIND	92-07-102
326-02-070	AMD-P	92-07-103	326-08-110	AMD-P	92-11-018	326-20-094	AMD-E	92-07-102
326-02-070	AMD	92-11-007	326-08-110	AMD-E	92-11-019	326-20-094	AMD-P	92-07-103
326-02-080	AMD-E	92-07-001	326-08-110	AMD	92-15-077	326-20-094	AMD	92-11-007
326-02-080	RESCIND	92-07-102	326-08-120	AMD-E	92-07-001	326-20-095	AMD-E	92-07-001
326-02-080	AMD-E	92-07-102	326-08-120	AMD-P	92-11-018	326-20-095	RESCIND	92-07-102
326-02-080	AMD-P	92-07-103	326-08-120	AMD-E	92-11-019	326-20-095	AMD-E	92-07-102
326-02-080	AMD	92-11-007	326-08-120	AMD	92-15-077	326-20-095	AMD-P	92-07-103
326-02-090	AMD-E	92-07-001	326-08-130	AMD-E	92-07-001	326-20-095	AMD	92-11-007
326-02-090	RESCIND	92-07-102	326-08-130	AMD-P	92-11-018	326-20-096	AMD-E	92-07-001
326-02-090	AMD-E	92-07-102	326-08-130	AMD-E	92-11-019	326-20-096	RESCIND	92-07-102
326-02-090	AMD-P	92-07-103	326-08-130	AMD	92-15-077	326-20-096	AMD-E	92-07-102
326-02-090	AMD	92-11-007	326-08-140	NEW-E	92-07-001	326-20-096	AMD-P	92-07-103
326-08-010	AMD-E	92-07-001	326-08-140	NEW-P	92-11-018	326-20-096	AMD	92-11-007
326-08-010	AMD-P	92-11-018	326-08-140	NEW-E	92-11-019	326-20-097	REP-E	92-07-001
326-08-010	AMD-E	92-11-019	326-08-140	NEW	92-15-077	326-20-097	RESCIND	92-07-102

Table of WAC Sections Affected

WAC #	WSR #	WAC #	WSR #	WAC #	WSR #
326-20-097	REP-E 92-07-102	326-20-190	AMD 92-11-007	332-24-215	REP 92-14-096
326-20-097	REP-P 92-07-103	326-20-200	REP-E 92-07-001	332-24-217	NEW-P 92-11-075
326-20-097	REP 92-11-007	326-20-200	RESCIND 92-07-102	332-24-217	NEW 92-14-096
326-20-098	AMD-E 92-07-001	326-20-200	REP-E 92-07-102	332-24-221	AMD-P 92-11-075
326-20-098	RESCIND 92-07-102	326-20-200	REP-P 92-07-103	332-24-221	AMD 92-14-096
326-20-098	AMD-E 92-07-102	326-20-200	REP 92-11-007	332-24-231	REP-P 92-11-075
326-20-098	AMD-P 92-07-103	326-20-220	AMD-E 92-07-001	332-24-231	REP 92-14-096
326-20-098	AMD 92-11-007	326-20-220	RESCIND 92-07-102	332-24-232	REP-P 92-11-075
326-20-110	AMD-E 92-07-001	326-20-220	AMD-E 92-07-102	332-24-232	REP 92-14-096
326-20-110	RESCIND 92-07-102	326-20-220	AMD-P 92-07-103	332-24-234	REP-P 92-11-075
326-20-110	AMD-E 92-07-102	326-20-220	AMD 92-11-007	332-24-234	REP 92-14-096
326-20-110	AMD-P 92-07-103	326-30	AMD-P 92-09-151	332-24-236	REP-P 92-11-075
326-20-110	AMD 92-11-007	326-30-010	AMD-P 92-09-151	332-24-236	REP 92-14-096
326-20-115	AMD-E 92-07-001	326-30-020	AMD-P 92-09-151	332-24-238	REP-P 92-11-075
326-20-115	RESCIND 92-07-102	326-30-030	AMD-P 92-09-151	332-24-238	REP 92-14-096
326-20-115	AMD-E 92-07-102	326-30-035	REP-P 92-09-151	332-24-240	REP-P 92-11-075
326-20-115	AMD-P 92-07-103	326-30-036	REP-P 92-09-151	332-24-240	REP 92-14-096
326-20-115	AMD 92-11-007	326-30-037	REP-P 92-09-151	332-24-242	REP-P 92-11-075
326-20-120	AMD-E 92-07-001	326-30-038	REP-P 92-09-151	332-24-242	REP 92-14-096
326-20-120	RESCIND 92-07-102	326-30-039	REP-P 92-09-151	332-24-244	REP-P 92-11-075
326-20-120	AMD-E 92-07-102	326-30-03901	REP-P 92-09-151	332-24-244	REP 92-14-096
326-20-120	AMD-P 92-07-103	326-30-03902	REP-P 92-09-151	332-24-271	NEW-P 92-11-075
326-20-120	AMD 92-11-007	326-30-03903	REP-P 92-09-151	332-24-271	NEW 92-14-096
326-20-130	AMD-E 92-07-001	326-30-040	REP-P 92-09-151	332-24-271	REP-P 92-11-075
326-20-130	RESCIND 92-07-102	326-30-041	NEW-P 92-09-151	332-24-656	REP-P 92-11-075
326-20-130	AMD-E 92-07-102	326-30-041	NEW-E 92-14-121	332-24-656	REP 92-14-096
326-20-130	AMD-P 92-07-103	326-30-046	NEW-P 92-09-151	332-26-010	NEW-E 92-14-131
326-20-130	AMD 92-11-007	326-30-050	REP-P 92-09-151	332-26-040	NEW-E 92-14-131
326-20-140	AMD-E 92-07-001	326-30-051	NEW-P 92-09-151	332-26-050	NEW-E 92-14-131
326-20-140	RESCIND 92-07-102	326-30-060	REP-P 92-09-151	332-26-060	NEW-E 92-14-131
326-20-140	AMD-E 92-07-102	326-30-070	REP-P 92-09-151	332-26-080	NEW-E 92-09-061
326-20-140	AMD-P 92-07-103	326-30-080	REP-P 92-09-151	332-26-081	NEW-E 92-13-057
326-20-140	AMD 92-11-007	326-30-090	REP-P 92-09-151	332-52-065	AMD 92-05-036
326-20-150	AMD-E 92-07-001	326-30-100	REP-P 92-09-151	332-130-010	AMD 92-03-007
326-20-150	RESCIND 92-07-102	326-30-110	AMD-P 92-09-151	332-130-020	AMD 92-03-007
326-20-150	AMD-E 92-07-102	326-40-010	AMD-P 92-09-151	332-130-025	NEW 92-03-007
326-20-150	AMD-P 92-07-103	326-40-020	AMD-P 92-09-151	352-32-011	AMD 92-04-072
326-20-150	AMD 92-11-007	326-40-030	NEW-P 92-09-151	352-32-235	AMD-P 92-12-080
326-20-160	AMD-E 92-07-001	326-40-040	NEW-P 92-09-151	352-32-235	AMD 92-15-118
326-20-160	RESCIND 92-07-102	326-40-050	NEW-P 92-09-151	352-32-250	AMD-P 92-07-083
326-20-160	AMD-E 92-07-102	326-40-060	NEW-P 92-09-151	352-32-250	AMD 92-10-018
326-20-160	AMD-P 92-07-103	326-40-070	NEW-P 92-09-151	352-32-25002	AMD 92-05-002
326-20-160	AMD 92-11-007	326-40-075	NEW-P 92-09-151	352-32-260	AMD-P 92-12-012
326-20-170	AMD-E 92-07-001	326-40-080	NEW-P 92-09-151	352-32-260	AMD 92-15-119
326-20-170	RESCIND 92-07-102	326-40-090	NEW-P 92-09-151	352-32-265	AMD-P 92-09-160
326-20-170	AMD-E 92-07-102	326-40-100	AMD-P 92-09-151	352-32-265	AMD-W 92-11-081
326-20-170	AMD-P 92-07-103	332-08-125	AMD-P 92-15-137	352-32-270	AMD-P 92-09-159
326-20-170	AMD 92-11-007	332-08-315	AMD-P 92-15-137	352-32-270	AMD-W 92-12-052
326-20-171	AMD-E 92-07-001	332-08-405	AMD-P 92-15-137	352-32-270	AMD-P 92-12-081
326-20-171	RESCIND 92-07-102	332-08-515	AMD-P 92-15-137	352-32-270	AMD 92-15-120
326-20-171	AMD-E 92-07-102	332-08-545	AMD-P 92-15-137	352-32-295	AMD-P 92-09-158
326-20-171	AMD-P 92-07-103	332-10-170	AMD-P 92-12-074	352-32-295	AMD-W 92-11-025
326-20-171	AMD 92-11-007	332-18-010	AMD-W 92-10-068	352-32-295	AMD-P 92-12-082
326-20-172	AMD-E 92-07-001	332-18-120	AMD-P 92-15-138	352-32-295	AMD 92-15-121
326-20-172	RESCIND 92-07-102	332-18-130	NEW-W 92-10-068	352-40-090	AMD-P 92-07-062
326-20-172	AMD-E 92-07-102	332-18-130	NEW-P 92-15-138	352-40-090	AMD 92-10-019
326-20-172	AMD-P 92-07-103	332-22-020	AMD 92-06-003	356-05-214	NEW 92-03-099
326-20-172	AMD 92-11-007	332-22-050	AMD-W 92-12-075	356-05-355	AMD-P 92-04-034
326-20-173	AMD-E 92-07-001	332-22-070	NEW-W 92-12-075	356-05-355	AMD 92-08-009
326-20-173	RESCIND 92-07-102	332-22-100	AMD-W 92-12-075	356-06-055	AMD-P 92-06-089
326-20-173	AMD-E 92-07-102	332-22-105	AMD-W 92-12-075	356-06-055	AMD-C 92-10-011
326-20-173	AMD-P 92-07-103	332-22-160	NEW 92-06-003	356-06-055	AMD-C 92-12-030
326-20-173	AMD 92-11-007	332-22-170	NEW 92-06-003	356-06-055	AMD 92-14-068
326-20-180	AMD-E 92-07-001	332-22-180	NEW 92-06-003	356-15-060	AMD-P 92-06-090
326-20-180	RESCIND 92-07-102	332-22-190	NEW 92-06-003	356-15-060	AMD-C 92-10-012
326-20-180	AMD-E 92-07-102	332-22-200	NEW 92-06-003	356-15-060	AMD-C 92-12-029
326-20-180	AMD-P 92-07-103	332-22-210	NEW 92-06-003	356-15-060	AMD 92-14-063
326-20-180	AMD 92-11-007	332-22-220	NEW 92-06-003	356-15-063	AMD-P 92-08-092
326-20-185	AMD-E 92-07-001	332-22-230	NEW 92-06-003	356-15-063	AMD-C 92-12-031
326-20-185	RESCIND 92-07-102	332-22-240	NEW 92-06-003	356-15-063	AMD 92-14-064
326-20-185	AMD-E 92-07-102	332-24-201	AMD-P 92-11-075	356-18-060	AMD 92-03-098
326-20-185	AMD-P 92-07-103	332-24-201	AMD 92-14-096	356-18-116	AMD 92-03-101
326-20-185	AMD 92-11-007	332-24-205	AMD-P 92-11-075	356-18-220	AMD-P 92-08-091
326-20-190	AMD-E 92-07-001	332-24-205	AMD 92-14-096	356-18-220	AMD 92-12-033
326-20-190	RESCIND 92-07-102	332-24-211	AMD-P 92-11-075	356-22-035	NEW-P 92-10-066
326-20-190	AMD-E 92-07-102	332-24-211	AMD 92-14-096	356-22-035	NEW 92-14-066
326-20-190	AMD-P 92-07-103	332-24-215	REP-P 92-11-075	356-22-036	NEW-P 92-10-066
				356-22-036	NEW 92-14-066



Table of WAC Sections Affected

WAC #	WSR #	WAC #	WSR #	WAC #	WSR #			
356-30-240	AMD-P	92-14-065	365-200-050	NEW	92-06-005	388-14-205	AMD	92-13-026
356-34-010	AMD-P	92-08-096	365-200-060	NEW	92-06-005	388-14-270	AMD-P	92-08-001
356-34-010	AMD-W	92-12-032	365-200-070	NEW	92-06-005	388-14-270	AMD	92-13-026
356-34-060	AMD-P	92-04-034	374-50-010	NEW-P	92-06-060	388-14-273	NEW-P	92-08-001
356-34-060	AMD	92-08-009	374-50-010	NEW	92-09-091	388-14-273	NEW	92-13-026
356-47-040	AMD	92-03-100	374-50-020	NEW-P	92-06-060	388-14-275	AMD-P	92-08-001
356-47-045	AMD-P	92-10-065	374-50-020	NEW	92-09-091	388-14-275	AMD	92-13-026
356-47-045	AMD	92-14-067	374-50-030	NEW-P	92-06-060	388-14-300	AMD-P	92-08-001
356-47-060	AMD-P	92-10-065	374-50-030	NEW	92-09-091	388-14-300	AMD	92-13-026
356-47-060	AMD	92-14-067	374-50-040	NEW-P	92-06-060	388-14-310	AMD-P	92-08-001
365-80-010	REP-P	92-09-146	374-50-040	NEW	92-09-091	388-14-310	AMD	92-13-026
365-80-010	REP-E	92-09-147	374-50-050	NEW-P	92-06-060	388-14-415	AMD-P	92-08-001
365-80-010	REP	92-15-047	374-50-050	NEW	92-09-091	388-14-415	AMD	92-13-026
365-80-020	REP-P	92-09-146	374-50-060	NEW-P	92-06-060	388-14-425	AMD-P	92-08-001
365-80-020	REP-E	92-09-147	374-50-060	NEW	92-09-091	388-14-425	AMD	92-13-026
365-80-020	REP	92-15-047	374-50-070	NEW-P	92-06-060	388-14-460	NEW-P	92-08-001
365-80-030	REP-P	92-09-146	374-50-070	NEW	92-09-091	388-14-460	NEW	92-13-026
365-80-030	REP-E	92-09-147	374-50-080	NEW-P	92-06-060	388-14-470	NEW-P	92-08-001
365-80-030	REP	92-15-047	374-50-080	NEW	92-09-091	388-14-470	NEW-W	92-13-025
365-80-040	REP-P	92-09-146	374-50-090	NEW-P	92-06-060	388-14-480	NEW-P	92-08-001
365-80-040	REP-E	92-09-147	374-50-090	NEW	92-09-091	388-14-480	NEW	92-13-026
365-80-040	REP	92-15-047	383-07-020	AMD-P	92-04-077	388-14-490	NEW-P	92-08-001
365-80-050	REP-P	92-09-146	383-07-020	AMD	92-09-048	388-14-490	NEW	92-13-026
365-80-050	REP-E	92-09-147	383-07-030	AMD-P	92-04-077	388-15-170	AMD-E	92-08-029
365-80-050	REP	92-15-047	383-07-030	AMD	92-09-048	388-15-170	AMD-P	92-08-030
365-80-060	REP-P	92-09-146	383-07-040	AMD-P	92-04-077	388-15-170	AMD	92-11-062
365-80-060	REP-E	92-09-147	383-07-040	AMD	92-09-048	388-15-615	NEW-P	92-15-130
365-80-060	REP	92-15-047	383-07-045	AMD-P	92-04-077	388-15-615	NEW-E	92-15-142
365-80-070	REP-P	92-09-146	383-07-045	AMD	92-09-048	388-22-030	AMD-P	92-07-051
365-80-070	REP-E	92-09-147	383-07-050	AMD-P	92-04-077	388-22-030	AMD	92-10-050
365-80-070	REP	92-15-047	383-07-050	AMD	92-09-048	388-24-044	AMD-P	92-15-143
365-80-080	REP-P	92-09-146	383-07-060	AMD-P	92-04-077	388-24-044	AMD-E	92-15-145
365-80-080	REP-E	92-09-147	383-07-060	AMD	92-09-048	388-24-074	AMD-C	92-04-024
365-80-080	REP	92-15-047	383-07-070	AMD-P	92-04-077	388-24-074	AMD	92-08-041
365-80-090	REP-P	92-09-146	383-07-070	AMD	92-09-048	388-24-074	AMD-P	92-10-034
365-80-090	REP-E	92-09-147	383-07-080	AMD-P	92-04-077	388-24-074	AMD	92-14-031
365-80-090	REP	92-15-047	383-07-080	AMD	92-09-048	388-24-125	AMD-P	92-08-005
365-80-100	NEW-P	92-09-146	383-07-090	AMD-P	92-04-077	388-24-125	AMD-E	92-08-006
365-80-100	NEW-E	92-09-147	383-07-090	AMD	92-09-048	388-24-125	AMD	92-11-056
365-80-100	NEW	92-15-047	383-07-100	AMD-P	92-04-077	388-24-250	AMD-P	92-03-113
365-80-110	NEW-P	92-09-146	383-07-100	AMD	92-09-048	388-24-250	AMD	92-09-021
365-80-110	NEW-E	92-09-147	383-07-115	NEW-P	92-04-077	388-24-250	AMD-P	92-15-074
365-80-110	NEW	92-15-047	383-07-115	NEW	92-09-048	388-24-252	NEW-P	92-03-114
365-80-120	NEW-P	92-09-146	383-07-120	AMD-P	92-04-077	388-24-252	NEW	92-09-022
365-80-120	NEW-E	92-09-147	383-07-120	AMD	92-09-048	388-24-253	AMD-P	92-03-115
365-80-120	NEW	92-15-047	383-07-130	AMD-P	92-04-077	388-24-253	AMD	92-09-023
365-80-130	NEW-P	92-09-146	383-07-130	AMD	92-09-048	388-24-254	AMD-P	92-03-116
365-80-130	NEW-E	92-09-147	388-11	AMD-C	92-04-021	388-24-254	AMD	92-09-024
365-80-130	NEW	92-15-047	388-11-015	AMD-P	92-08-001	388-24-255	AMD-P	92-03-117
365-80-140	NEW-P	92-09-146	388-11-015	AMD-W	92-13-025	388-24-255	AMD	92-09-025
365-80-140	NEW-E	92-09-147	388-11-032	NEW-P	92-08-001	388-24-265	AMD-P	92-03-118
365-80-140	NEW	92-15-047	388-11-032	NEW	92-13-026	388-24-265	AMD	92-09-026
365-80-150	NEW-P	92-09-146	388-11-040	AMD-P	92-08-001	388-28-430	REP-P	92-13-031
365-80-150	NEW-E	92-09-147	388-11-040	AMD	92-13-026	388-28-430	REP-E	92-13-033
365-80-150	NEW	92-15-047	388-11-043	NEW-P	92-08-001	388-28-435	AMD-P	92-13-031
365-80-160	NEW-P	92-09-146	388-11-043	NEW-W	92-13-025	388-28-435	AMD-E	92-13-033
365-80-160	NEW-E	92-09-147	388-11-048	NEW-P	92-08-001	388-28-438	AMD-P	92-13-031
365-80-160	NEW	92-15-047	388-11-048	NEW	92-13-026	388-28-438	AMD-E	92-13-033
365-80-170	NEW-P	92-09-146	388-11-055	AMD	92-08-034	388-28-438	AMD-P	92-13-031
365-80-170	NEW-E	92-09-147	388-11-060	AMD-P	92-08-001	388-28-439	AMD-E	92-13-033
365-80-170	NEW	92-15-047	388-11-060	AMD	92-13-026	388-28-440	AMD-P	92-13-031
365-80-180	NEW-P	92-09-146	388-11-065	AMD-P	92-08-001	388-28-440	AMD-E	92-13-033
365-80-180	NEW-E	92-09-147	388-11-065	AMD	92-13-026	388-28-450	AMD-P	92-13-031
365-80-180	NEW	92-15-047	388-11-140	AMD	92-08-034	388-28-450	AMD-E	92-13-033
365-80-190	NEW-P	92-09-146	388-11-155	AMD-P	92-08-001	388-28-473	AMD-P	92-13-031
365-80-190	NEW-E	92-09-147	388-11-155	AMD	92-13-026	388-28-473	AMD-E	92-13-033
365-80-190	NEW	92-15-047	388-11-195	REP	92-08-034	388-28-474	AMD-P	92-13-031
365-80-200	NEW-P	92-09-146	388-11-200	REP	92-08-034	388-28-474	AMD-E	92-13-033
365-80-200	NEW-E	92-09-147	388-11-205	AMD	92-08-034	388-28-475	AMD-P	92-13-031
365-80-200	NEW	92-15-047	388-11-210	AMD	92-08-034	388-28-475	AMD-E	92-13-033
365-180-030	AMD	92-03-019	388-14-020	AMD-P	92-08-001	388-28-481	AMD-P	92-13-031
365-180-060	AMD	92-03-019	388-14-020	AMD	92-13-026	388-28-481	AMD-E	92-13-033
365-180-090	AMD	92-03-019	388-14-200	AMD-P	92-08-001	388-28-482	AMD-P	92-13-031
365-200-010	NEW	92-06-005	388-14-200	AMD	92-13-026	388-28-482	AMD-E	92-13-033
365-200-020	NEW	92-06-005	388-14-203	NEW-P	92-08-001	388-28-483	AMD-P	92-15-131
365-200-030	NEW	92-06-005	388-14-203	NEW	92-13-026	388-28-483	AMD-E	92-15-132
365-200-040	NEW	92-06-005	388-14-205	AMD-P	92-08-001	388-28-484	AMD-P	92-13-031



### Table of WAC Sections Affected

WAC #	WSR #	WAC #	WSR #	WAC #	WSR #			
388-28-484	AMD-E	92-13-033	388-49-310	AMD-P	92-10-028	388-73-034	AMD	92-08-056
388-28-535	AMD	92-03-090	388-49-310	AMD-E	92-10-029	388-73-036	AMD	92-08-056
388-28-570	AMD-P	92-04-013	388-49-310	AMD	92-14-030	388-73-038	AMD	92-08-056
388-28-570	AMD-E	92-04-014	388-49-330	AMD-P	92-08-012	388-73-042	AMD	92-08-056
388-28-570	AMD	92-08-033	388-49-330	AMD-E	92-08-015	388-73-052	AMD	92-08-056
388-28-575	AMD-P	92-05-005	388-49-330	AMD	92-11-058	388-73-054	AMD	92-08-056
388-28-575	AMD-E	92-05-008	388-49-410	AMD-P	92-06-042	388-73-056	AMD	92-08-056
388-28-575	AMD	92-09-029	388-49-410	AMD-E	92-06-045	388-73-057	AMD	92-08-056
388-28-590	AMD-P	92-13-031	388-49-410	AMD	92-09-117	388-73-060	AMD	92-08-056
388-28-590	AMD-E	92-13-033	388-49-470	AMD	92-03-119	388-73-060	AMD-P	92-12-009
388-29-001	AMD-P	92-07-050	388-49-470	AMD-P	92-08-108	388-73-060	AMD	92-15-043
388-29-001	AMD	92-10-048	388-49-470	AMD-E	92-08-109	388-73-062	AMD	92-08-056
388-29-005	REP-P	92-11-002	388-49-470	AMD	92-11-063	388-73-064	AMD	92-08-056
388-29-005	REP-C	92-14-050	388-49-500	AMD-P	92-05-043	388-73-069	AMD-P	92-12-009
388-29-005	REP-C	92-15-059	388-49-500	AMD-E	92-05-045	388-73-069	AMD	92-15-043
388-29-270	AMD-P	92-05-035	388-49-500	AMD	92-09-031	388-73-070	AMD	92-08-056
388-29-270	AMD	92-09-033	388-49-520	AMD	92-03-086	388-73-077	AMD	92-08-056
388-29-295	AMD-P	92-15-027	388-49-520	AMD-P	92-13-051	388-73-078	AMD	92-08-056
388-29-295	AMD-E	92-15-029	388-49-530	AMD-P	92-13-052	388-73-080	AMD	92-08-056
388-33-015	AMD-P	92-07-049	388-49-560	AMD-P	92-12-041	388-73-100	AMD	92-08-056
388-33-015	AMD	92-10-047	388-49-560	AMD	92-15-039	388-73-102	AMD	92-08-056
388-33-377	REP-P	92-11-002	388-49-580	AMD-C	92-04-020	388-73-102	AMD-P	92-12-009
388-33-377	REP-C	92-14-050	388-49-580	AMD	92-08-035	388-73-102	AMD	92-15-043
388-33-377	REP-C	92-15-059	388-49-590	AMD-P	92-09-066	388-73-103	AMD	92-08-056
388-33-379	NEW-P	92-11-002	388-49-590	AMD	92-12-042	388-73-104	AMD	92-08-056
388-33-379	NEW-C	92-14-050	388-49-630	AMD-P	92-13-053	388-73-106	AMD	92-08-056
388-33-379	NEW-C	92-15-059	388-49-640	AMD-P	92-09-037	388-73-108	AMD	92-08-056
388-33-389	AMD-P	92-11-002	388-49-640	AMD	92-12-043	388-73-108	AMD-P	92-12-009
388-33-389	AMD-C	92-14-050	388-49-660	AMD-P	92-09-028	388-73-108	AMD	92-15-043
388-33-389	AMD-C	92-15-059	388-49-660	AMD	92-12-044	388-73-110	AMD	92-08-056
388-33-460	AMD	92-03-089	388-49-700	AMD-P	92-09-066	388-73-112	AMD	92-08-056
388-33-480	REP	92-03-085	388-49-700	AMD	92-12-042	388-73-116	AMD	92-08-056
388-37-031	REP-P	92-07-048	388-51-010	AMD-P	92-04-013	388-73-118	AMD	92-08-056
388-37-031	REP	92-10-049	388-51-010	AMD-E	92-04-014	388-73-118	AMD-P	92-12-009
388-37-038	AMD-P	92-02-102	388-51-010	AMD	92-08-033	388-73-118	AMD	92-15-043
388-37-038	AMD-C	92-04-023	388-51-100	REP-P	92-04-013	388-73-120	AMD	92-08-056
388-37-038	AMD	92-08-036	388-51-100	REP-E	92-04-014	388-73-126	AMD	92-08-056
388-37-039	NEW-P	92-07-048	388-51-100	REP	92-08-033	388-73-128	AMD	92-08-056
388-37-039	NEW	92-10-049	388-51-110	NEW-P	92-04-013	388-73-130	AMD	92-08-056
388-37-135	AMD	92-03-047	388-51-110	NEW-E	92-04-014	388-73-132	AMD	92-08-056
388-37-300	NEW-P	92-14-094	388-51-110	NEW	92-08-033	388-73-134	AMD	92-08-056
388-37-300	NEW-E	92-14-095	388-51-115	NEW-P	92-04-013	388-73-136	AMD	92-08-056
388-37-310	NEW-P	92-14-094	388-51-115	NEW-E	92-04-014	388-73-138	AMD	92-08-056
388-37-310	NEW-E	92-14-095	388-51-115	NEW	92-08-033	388-73-140	AMD	92-08-056
388-37-320	NEW-P	92-14-094	388-51-120	NEW-P	92-04-013	388-73-142	AMD	92-08-056
388-37-320	NEW-E	92-14-095	388-51-120	NEW-E	92-04-014	388-73-143	AMD	92-08-056
388-37-330	NEW-P	92-14-094	388-51-120	NEW	92-08-033	388-73-144	AMD	92-08-056
388-37-330	NEW-E	92-14-095	388-51-123	NEW-P	92-04-013	388-73-146	AMD	92-08-056
388-37-340	NEW-P	92-14-094	388-51-123	NEW-E	92-04-014	388-73-202	AMD	92-08-056
388-37-340	NEW-E	92-14-095	388-51-123	NEW	92-08-033	388-73-208	AMD	92-08-056
388-37-350	NEW-P	92-14-094	388-51-125	NEW-P	92-04-013	388-73-210	AMD	92-08-056
388-37-350	NEW-E	92-14-095	388-51-125	NEW-E	92-04-014	388-73-210	AMD-P	92-12-009
388-37-360	NEW-P	92-14-094	388-51-125	NEW	92-08-033	388-73-210	AMD	92-15-043
388-37-360	NEW-E	92-14-095	388-51-130	NEW-P	92-04-013	388-73-212	AMD	92-08-056
388-37-370	NEW-P	92-14-094	388-51-130	NEW-E	92-04-014	388-73-212	AMD-P	92-12-009
388-37-370	NEW-E	92-14-095	388-51-130	NEW	92-08-033	388-73-212	AMD	92-15-043
388-37-380	NEW-P	92-14-094	388-51-132	NEW-P	92-04-013	388-73-213	NEW	92-08-056
388-37-380	NEW-E	92-14-095	388-51-132	NEW-E	92-04-014	388-73-214	AMD	92-08-056
388-42-020	AMD-P	92-13-041	388-51-135	NEW-P	92-04-013	388-73-216	AMD	92-08-056
388-42-020	AMD-E	92-13-044	388-51-135	NEW-E	92-04-014	388-73-216	AMD-P	92-12-009
388-42-025	AMD-P	92-13-041	388-51-135	NEW	92-08-033	388-73-216	AMD	92-15-043
388-42-025	AMD-E	92-13-044	388-51-140	NEW-P	92-04-013	388-73-302	AMD	92-08-056
388-42-030	AMD-P	92-13-041	388-51-140	NEW-E	92-04-014	388-73-304	AMD	92-08-056
388-42-030	AMD-E	92-13-044	388-51-140	NEW	92-08-033	388-73-306	AMD	92-08-056
388-42-150	AMD-P	92-13-041	388-73	AMD-C	92-04-035	388-73-308	AMD	92-08-056
388-42-150	AMD-E	92-13-044	388-73	AMD-C	92-06-011	388-73-310	AMD	92-08-056
388-47-070	AMD-P	92-15-028	388-73	AMD	92-15-043	388-73-312	AMD	92-08-056
388-47-115	AMD-P	92-09-081	388-73-012	AMD	92-08-056	388-73-400	AMD-P	92-12-009
388-47-115	AMD	92-12-045	388-73-014	AMD	92-08-056	388-73-400	AMD	92-15-043
388-49-020	AMD-P	92-08-010	388-73-016	AMD	92-08-056	388-73-409	AMD	92-08-056
388-49-020	AMD-E	92-08-014	388-73-018	AMD	92-08-056	388-73-414	AMD	92-08-056
388-49-020	AMD	92-11-059	388-73-01950	AMD-P	92-12-009	388-73-420	REP-P	92-12-009
388-49-110	AMD-P	92-05-044	388-73-01950	AMD	92-15-043	388-73-420	REP	92-15-043
388-49-110	AMD-E	92-05-046	388-73-024	AMD	92-08-056	388-73-422	REP-P	92-12-009
388-49-110	AMD	92-09-032	388-73-026	AMD	92-08-056	388-73-422	REP	92-15-043
388-49-180	AMD-P	92-07-047	388-73-028	AMD	92-08-056	388-73-423	REP-P	92-12-009
388-49-180	AMD	92-09-116	388-73-030	AMD	92-08-056	388-73-423	REP	92-15-043

Table of WAC Sections Affected

WAC #		WSR #	WAC #		WSR #	WAC #		WSR #
388-73-424	REP-P	92-12-009	388-76-465	AMD-P	92-15-144	388-87-027	AMD-P	92-14-078
388-73-424	REP	92-15-043	388-76-467	NEW-P	92-15-144	388-87-032	NEW-P	92-08-107
388-73-426	REP-P	92-12-009	388-76-475	AMD-P	92-15-144	388-87-032	NEW	92-11-003
388-73-426	REP	92-15-043	388-76-480	AMD-P	92-15-144	388-88-001	AMD-P	92-03-015
388-73-428	REP-P	92-12-009	388-76-490	AMD-P	92-15-144	388-88-001	AMD	92-08-074
388-73-428	REP	92-15-043	388-76-500	AMD-P	92-15-144	388-88-075	AMD-P	92-03-015
388-73-450	REP-P	92-12-009	388-76-520	AMD-P	92-15-144	388-88-075	AMD	92-08-074
388-73-450	REP	92-15-043	388-76-530	AMD-P	92-15-144	388-88-080	AMD-P	92-03-015
388-73-452	REP-P	92-12-009	388-77-256	REP	92-04-003	388-88-080	AMD	92-08-074
388-73-452	REP	92-15-043	388-80-005	AMD-W	92-04-019	388-88-081	AMD-P	92-03-015
388-73-454	REP-P	92-12-009	388-80-005	RESCIND	92-04-019	388-88-081	AMD	92-08-074
388-73-454	REP	92-15-043	388-80-005	AMD-P	92-13-054	388-88-082	REP-P	92-03-015
388-73-458	REP-P	92-12-009	388-81-017	NEW	92-05-050	388-88-082	AMD	92-08-074
388-73-458	REP	92-15-043	388-81-038	NEW	92-03-084	388-88-083	REP-P	92-03-015
388-73-460	REP-P	92-12-009	388-81-047	AMD-P	92-03-112	388-88-083	REP	92-08-074
388-73-460	REP	92-15-043	388-81-047	AMD-E	92-03-121	388-88-084	REP-P	92-03-015
388-73-504	AMD	92-08-056	388-81-047	AMD	92-07-029	388-88-084	REP	92-08-074
388-73-506	AMD	92-08-056	388-81-050	AMD-P	92-03-042	388-88-084	AMD-P	92-03-015
388-73-512	AMD	92-08-056	388-81-050	AMD-E	92-03-044	388-88-095	AMD	92-08-074
388-73-602	AMD	92-08-056	388-81-050	AMD	92-07-028	388-88-095	AMD	92-08-074
388-73-604	AMD	92-08-056	388-82-115	AMD	92-03-046	388-88-097	AMD-P	92-03-015
388-73-606	AMD	92-08-056	388-82-140	AMD-P	92-08-080	388-88-097	AMD	92-08-074
388-73-608	REP	92-08-056	388-82-140	AMD-E	92-08-081	388-88-098	AMD-P	92-03-015
388-73-610	AMD	92-08-056	388-82-140	AMD	92-11-057	388-88-098	AMD	92-08-074
388-73-702	AMD	92-08-056	388-82-160	AMD-P	92-08-080	388-88-099	AMD-P	92-03-015
388-73-704	AMD	92-08-056	388-82-160	AMD-E	92-08-081	388-88-099	AMD	92-08-074
388-73-706	AMD	92-08-056	388-82-160	AMD	92-11-057	388-88-100	REP-P	92-03-015
388-73-708	AMD	92-08-056	388-83-010	AMD-P	92-15-007	388-88-100	REP	92-08-074
388-73-710	AMD	92-08-056	388-83-010	AMD-E	92-14-009	388-88-101	REP-P	92-03-015
388-73-712	AMD	92-08-056	388-83-012	AMD-P	92-08-013	388-88-101	REP	92-08-074
388-73-714	AMD	92-08-056	388-83-012	AMD-E	92-08-017	388-88-102	AMD-P	92-03-015
388-73-716	REP	92-08-056	388-83-012	AMD	92-11-061	388-88-102	AMD	92-08-074
388-73-720	AMD	92-08-056	388-83-013	AMD	92-03-087	388-88-125	NEW-P	92-03-015
388-73-722	AMD	92-08-056	388-83-013	AMD-P	92-15-007	388-88-125	NEW	92-08-074
388-73-804	AMD	92-08-056	388-83-013	AMD-E	92-14-009	388-88-130	NEW-P	92-03-015
388-73-815	NEW	92-08-056	388-83-014	AMD-P	92-15-007	388-88-130	NEW	92-08-074
388-73-820	AMD	92-08-056	388-83-014	AMD-E	92-14-009	388-88-135	NEW-P	92-03-015
388-73-901	NEW	92-08-056	388-83-032	AMD-P	92-08-080	388-88-135	NEW	92-08-074
388-73-901	AMD-P	92-12-009	388-83-032	AMD-E	92-08-081	388-88-140	NEW-P	92-03-015
388-73-901	AMD	92-15-043	388-83-032	AMD	92-11-057	388-88-145	NEW-P	92-03-015
388-73-902	AMD	92-08-056	388-83-033	AMD	92-03-083	388-88-145	NEW	92-08-074
388-76-030	AMD-P	92-15-144	388-83-033	AMD	92-03-083	388-92-025	AMD-P	92-11-053
388-76-040	AMD-P	92-15-144	388-83-033	AMD-P	92-08-080	388-92-025	AMD-E	92-12-046
388-76-045	AMD-P	92-15-144	388-83-033	AMD-E	92-09-019	388-92-025	AMD	92-14-051
388-76-070	AMD-P	92-15-144	388-83-033	AMD	92-11-057	388-92-034	AMD-P	92-08-011
388-76-080	AMD-P	92-15-144	388-83-036	AMD-P	92-11-054	388-92-034	AMD-E	92-08-016
388-76-085	AMD-P	92-15-144	388-83-036	AMD-E	92-12-047	388-92-034	AMD	92-11-060
388-76-087	AMD-P	92-15-144	388-83-036	AMD	92-14-052	388-92-045	AMD-C	92-04-025
388-76-090	AMD-P	92-15-144	388-83-041	AMD-P	92-05-006	388-92-045	AMD	92-08-037
388-76-100	AMD-P	92-15-144	388-83-041	AMD-E	92-05-007	388-95-337	AMD	92-03-088
388-76-110	AMD-P	92-15-144	388-83-041	AMD	92-09-030	388-95-360	AMD-P	92-03-147
388-76-130	AMD-P	92-15-144	388-86-005	AMD	92-03-084	388-95-360	AMD-E	92-03-149
388-76-155	AMD-P	92-15-144	388-86-00901	REP-P	92-10-074	388-95-360	AMD-C	92-07-053
388-76-160	AMD-P	92-15-144	388-86-00901	REP-E	92-10-076	388-95-360	AMD	92-08-082
388-76-170	AMD-P	92-15-144	388-86-00901	REP	92-13-029	388-95-360	AMD-E	92-08-083
388-76-180	AMD-P	92-15-144	388-86-00902	NEW-P	92-10-074	388-95-360	AMD	92-10-046
388-76-185	AMD-P	92-15-144	388-86-00902	NEW-E	92-10-076	388-96-026	AMD-P	92-13-042
388-76-200	AMD-P	92-15-144	388-86-00902	NEW	92-13-029	388-96-026	AMD-E	92-13-043
388-76-220	AMD-P	92-15-144	388-86-011	NEW-P	92-08-107	388-96-032	AMD-P	92-13-042
388-76-240	AMD-P	92-15-144	388-86-011	NEW	92-11-003	388-96-032	AMD-E	92-13-043
388-76-250	AMD-P	92-15-144	388-86-019	AMD	92-03-120	388-96-101	AMD-P	92-13-042
388-76-260	AMD-P	92-15-144	388-86-021	AMD-W	92-13-001	388-96-101	AMD-E	92-13-043
388-76-280	AMD-P	92-15-144	388-86-047	AMD-P	92-10-075	388-96-110	AMD-P	92-13-042
388-76-290	AMD-P	92-15-144	388-86-047	AMD-E	92-10-077	388-96-110	AMD-E	92-13-043
388-76-300	AMD-P	92-15-144	388-86-047	AMD	92-13-030	388-96-113	AMD-P	92-13-042
388-76-310	AMD-P	92-15-144	388-86-073	AMD-W	92-13-001	388-96-113	AMD-E	92-13-043
388-76-340	AMD-P	92-15-144	388-86-080	AMD-P	92-03-041	388-96-505	AMD-P	92-13-042
388-76-350	AMD-P	92-15-144	388-86-080	AMD-E	92-03-043	388-96-505	AMD-E	92-13-043
388-76-360	AMD-P	92-15-144	388-86-080	AMD	92-07-026	388-96-710	AMD-P	92-13-042
388-76-370	AMD-P	92-15-144	388-86-090	AMD-W	92-13-001	388-96-710	AMD-E	92-13-043
388-76-390	AMD-P	92-15-144	388-86-09601	AMD	92-03-120	388-96-716	AMD-E	92-13-043
388-76-405	NEW-P	92-15-144	388-86-09601	AMD-P	92-14-079	388-96-716	AMD-P	92-13-042
388-76-410	AMD-P	92-15-144	388-86-09601	AMD-E	92-14-081	388-96-722	AMD-E	92-13-043
388-76-420	AMD-P	92-15-144	388-86-098	AMD-W	92-13-001	388-96-745	AMD-P	92-13-042
388-76-430	AMD-P	92-15-144	388-86-100	AMD-W	92-13-001	388-96-745	AMD-E	92-13-043
388-76-435	AMD-P	92-15-144	388-86-110	AMD-P	92-14-078	388-96-763	AMD-P	92-13-042
388-76-440	AMD-P	92-15-144	388-86-120	AMD-W	92-13-001	388-96-763	AMD-E	92-13-043

Table of WAC Sections Affected

WAC #	WSR #	WAC #	WSR #	WAC #	WSR #			
388-99-030	AMD-P	92-03-111	392-122-255	AMD	92-03-045	392-140-442	NEW	92-03-023
388-99-030	AMD-E	92-03-122	392-122-255	AMD-P	92-15-094	392-140-443	NEW	92-03-023
388-99-030	AMD	92-07-027	392-122-260	AMD	92-03-045	392-140-444	NEW	92-03-023
388-99-060	AMD-W	92-13-001	392-122-265	AMD	92-03-138	392-140-445	NEW	92-03-023
388-99-060	AMD-P	92-14-079	392-122-270	AMD	92-03-045	392-140-446	NEW	92-03-023
388-99-060	AMD-E	92-14-081	392-122-275	AMD	92-03-045	392-140-447	NEW	92-03-023
388-100-035	AMD-W	92-13-001	392-122-300	NEW	92-03-138	392-140-450	NEW	92-03-023
388-100-035	AMD-P	92-14-079	392-122-301	NEW	92-03-138	392-140-451	NEW	92-03-023
388-100-035	AMD-E	92-14-081	392-122-302	NEW	92-03-138	392-140-452	NEW	92-03-023
388-320-110	REP-W	92-09-038	392-122-303	NEW	92-03-138	392-140-460	NEW	92-03-023
388-320-135	REP-W	92-09-038	392-122-304	NEW	92-03-138	392-140-461	NEW	92-03-023
388-330-030	AMD-P	92-02-101	392-122-320	NEW	92-03-138	392-140-462	NEW	92-03-023
388-330-030	AMD-E	92-03-148	392-122-320	NEW-P	92-15-093	392-140-463	NEW	92-03-023
388-330-030	AMD-C	92-04-022	392-122-321	NEW	92-03-138	392-140-464	NEW	92-03-023
388-330-030	AMD	92-08-038	392-122-321	NEW-P	92-15-093	392-140-465	NEW	92-03-023
390-05-215	NEW	92-05-081	392-122-322	NEW	92-03-138	392-140-466	NEW	92-03-023
390-05-300	AMD	92-05-080	392-122-322	NEW-P	92-15-093	392-140-470	NEW	92-03-023
390-05-305	AMD	92-05-080	392-122-900	AMD-P	92-15-094	392-140-471	NEW	92-03-023
390-12-040	AMD-W	92-03-005	392-123-054	AMD	92-03-024	392-140-472	NEW	92-03-023
390-16-011	AMD-P	92-12-084	392-123-071	AMD	92-03-024	392-140-473	NEW	92-03-023
390-16-012	AMD-P	92-12-084	392-123-072	AMD	92-03-024	392-140-474	NEW	92-03-023
390-16-032	AMD-P	92-15-116	392-123-074	AMD	92-03-024	392-140-475	NEW	92-03-023
390-16-041	AMD	92-05-080	392-123-078	AMD	92-03-024	392-140-476	NEW	92-03-023
390-16-041	AMD-P	92-12-084	392-123-079	AMD	92-03-024	392-140-477	NEW	92-03-023
390-16-125	AMD	92-05-079	392-123-115	AMD	92-03-024	392-140-478	NEW	92-03-023
390-16-125	AMD-P	92-12-084	392-123-120	AMD	92-03-024	392-140-480	NEW	92-03-023
390-16-310	AMD	92-05-079	392-139-115	AMD-P	92-15-002	392-140-481	NEW	92-03-023
390-18-040	AMD-P	92-13-104	392-139-122	AMD-P	92-15-002	392-140-482	NEW	92-03-023
390-18-040	AMD	92-12-037	392-139-172	AMD-P	92-15-002	392-140-483	NEW	92-03-023
390-24-202	NEW-S	92-05-078	392-139-243	REP-P	92-15-002	392-140-485	NEW	92-03-023
390-24-202	NEW-E	92-05-082	392-139-310	AMD-P	92-15-002	392-140-486	NEW	92-03-023
390-24-202	NEW	92-08-105	392-139-674	REP-P	92-15-002	392-140-490	NEW	92-03-023
390-28-025	AMD	92-05-080	392-139-675	AMD-P	92-15-002	392-140-491	NEW	92-03-023
390-32-020	AMD-P	92-12-084	392-139-676	NEW-P	92-15-002	392-140-492	NEW	92-03-023
392-100	AMD	92-03-138	392-140-067	NEW	92-03-023	392-140-493	NEW	92-03-023
392-100-100	NEW	92-03-138	392-140-068	NEW	92-03-023	392-140-494	NEW	92-03-023
392-100-101	NEW	92-03-138	392-140-069	NEW	92-03-023	392-140-495	NEW	92-03-023
392-100-101	AMD-P	92-15-122	392-140-070	NEW	92-03-023	392-140-496	NEW	92-03-023
392-100-102	NEW	92-03-138	392-140-071	NEW	92-03-023	392-140-497	NEW	92-03-023
392-105-007	NEW-P	92-06-052	392-140-072	NEW	92-03-023	392-141-105	AMD-P	92-04-009
392-105-007	NEW	92-10-016	392-140-075	REP	92-03-023	392-141-105	AMD	92-08-024
392-105-013	REP-P	92-06-052	392-140-076	REP	92-03-023	392-141-110	AMD-P	92-04-009
392-105-013	REP	92-10-016	392-140-077	REP	92-03-023	392-141-110	AMD	92-08-024
392-105-015	AMD-P	92-06-052	392-140-078	REP	92-03-023	392-141-115	AMD-P	92-04-009
392-105-015	AMD	92-10-016	392-140-079	REP	92-03-023	392-141-115	AMD	92-08-024
392-105-020	AMD-P	92-06-052	392-140-080	REP	92-03-023	392-141-120	AMD-P	92-04-009
392-105-020	AMD	92-10-016	392-140-081	REP	92-03-023	392-141-120	AMD	92-08-024
392-105-025	AMD-P	92-06-052	392-140-082	REP	92-03-023	392-141-125	AMD-P	92-04-009
392-105-025	AMD	92-10-016	392-140-083	REP	92-03-023	392-141-125	AMD	92-08-024
392-105-030	AMD-P	92-06-052	392-140-160	REP	92-03-023	392-141-130	AMD-P	92-04-009
392-105-030	AMD	92-10-016	392-140-161	REP	92-03-023	392-141-130	AMD	92-08-024
392-105-035	AMD-P	92-06-052	392-140-162	REP	92-03-023	392-141-135	NEW-P	92-04-009
392-105-035	AMD	92-10-016	392-140-163	REP	92-03-023	392-141-135	NEW	92-08-024
392-105-040	NEW-P	92-06-052	392-140-165	REP	92-03-023	392-141-140	AMD-P	92-04-009
392-105-040	NEW	92-10-016	392-140-166	REP	92-03-023	392-141-140	AMD	92-08-024
392-105-045	NEW-P	92-06-052	392-140-167	REP	92-03-023	392-141-145	AMD-P	92-04-009
392-105-045	NEW	92-10-016	392-140-168	REP	92-03-023	392-141-145	AMD	92-08-024
392-105-050	NEW-P	92-06-052	392-140-169	REP	92-03-023	392-141-146	NEW-P	92-04-009
392-105-050	NEW	92-10-016	392-140-170	REP	92-03-023	392-141-146	NEW	92-08-024
392-105-055	NEW-P	92-06-052	392-140-171	REP	92-03-023	392-141-147	NEW-P	92-04-009
392-105-055	NEW	92-10-016	392-140-172	REP	92-03-023	392-141-147	NEW	92-08-024
392-105-060	NEW-P	92-06-052	392-140-173	REP	92-03-023	392-141-148	NEW-P	92-04-009
392-105-060	NEW	92-10-016	392-140-174	REP	92-03-023	392-141-148	NEW	92-08-024
392-122-201	NEW	92-03-045	392-140-197	AMD	92-03-023	392-141-148	NEW-P	92-15-146
392-122-202	NEW	92-03-045	392-140-198	AMD	92-03-023	392-141-150	AMD-P	92-04-009
392-122-205	AMD	92-03-045	392-140-199	AMD	92-03-023	392-141-150	AMD	92-08-024
392-122-206	AMD	92-03-045	392-140-201	AMD	92-03-023	392-141-155	AMD-P	92-04-009
392-122-207	NEW	92-03-045	392-140-431	NEW	92-03-023	392-141-155	AMD	92-08-024
392-122-210	AMD	92-03-045	392-140-432	NEW	92-03-023	392-141-156	NEW-P	92-04-009
392-122-211	NEW	92-03-045	392-140-433	NEW	92-03-023	392-141-156	NEW	92-08-024
392-122-212	NEW	92-03-045	392-140-434	NEW	92-03-023	392-141-157	NEW-P	92-04-009
392-122-213	NEW	92-03-045	392-140-435	NEW	92-03-023	392-141-157	NEW	92-08-024
392-122-214	NEW	92-03-045	392-140-436	NEW	92-03-023	392-141-158	NEW-P	92-04-009
392-122-220	NEW	92-03-045	392-140-437	NEW	92-03-023	392-141-158	NEW	92-08-024
392-122-221	NEW	92-03-045	392-140-438	NEW	92-03-023	392-141-159	NEW-P	92-15-146
392-122-225	NEW	92-03-045	392-140-439	NEW	92-03-023	392-141-160	AMD-P	92-04-009
392-122-230	AMD	92-03-045	392-140-441	NEW	92-03-023	392-141-160	AMD	92-08-024

### Table of WAC Sections Affected

WAC #	WSR #	WAC #	WSR #	WAC #	WSR #			
392-141-165	AMD-P	92-04-009	392-163-445	AMD-P	92-10-062	392-175-020	NEW-P	92-06-053
392-141-165	AMD	92-08-024	392-163-450	AMD-P	92-10-062	392-175-025	NEW-P	92-06-053
392-141-170	AMD-P	92-04-009	392-163-455	AMD-P	92-10-062	392-175-025	NEW	92-15-071
392-141-170	AMD	92-08-024	392-163-460	AMD-P	92-10-062	392-196-005	AMD	92-05-068
392-141-175	AMD-P	92-04-009	392-163-465	AMD-P	92-10-062	392-196-045	AMD	92-05-068
392-141-175	AMD	92-08-024	392-163-470	NEW-P	92-10-062	392-196-080	AMD	92-05-068
392-141-180	AMD-P	92-04-009	392-163-475	NEW-P	92-10-062	392-196-085	AMD	92-05-068
392-141-180	AMD	92-08-024	392-163-480	NEW-P	92-10-062	392-196-090	REP	92-05-068
392-141-185	AMD-P	92-04-009	392-163-485	NEW-P	92-10-062	392-196-100	AMD	92-05-068
392-141-185	AMD	92-08-024	392-163-490	NEW-P	92-10-062	392-202-110	AMD-W	92-03-063
392-141-195	AMD-P	92-04-009	392-163-495	NEW-P	92-10-062	392-202-115	AMD-W	92-03-063
392-141-195	AMD	92-08-024	392-163-500	AMD-P	92-10-062	392-202-120	AMD-W	92-03-063
392-141-200	NEW-P	92-04-009	392-163-505	NEW-P	92-10-062	399-30-030	AMD	92-03-052
392-141-200	NEW	92-08-024	392-163-510	NEW-P	92-10-062	399-30-040	AMD	92-03-052
392-141-205	NEW-P	92-15-146	392-163-515	NEW-P	92-10-062	399-30-042	AMD	92-03-052
392-141-210	NEW-P	92-15-146	392-163-520	NEW-P	92-10-062	399-30-045	AMD	92-03-052
392-141-215	NEW-P	92-15-146	392-163-525	NEW-P	92-10-062	399-30-050	AMD	92-03-052
392-141-220	NEW-P	92-15-146	392-163-530	NEW-P	92-10-062	399-30-060	AMD	92-03-052
392-141-225	NEW-P	92-15-146	392-163-535	NEW-P	92-10-062	399-30-065	AMD	92-03-052
392-141-230	NEW-P	92-15-146	392-163-540	NEW-P	92-10-062	399-40-020	AMD	92-03-051
392-153-005	AMD	92-03-138	392-163-545	NEW-P	92-10-062	415-108-670	NEW-E	92-11-027
392-153-014	NEW	92-03-138	392-163-550	NEW-P	92-10-062	415-112-560	NEW-E	92-11-027
392-153-015	AMD	92-03-138	392-163-555	NEW-P	92-10-062	415-115-080	AMD-E	92-11-027
392-153-032	AMD	92-03-138	392-163-560	NEW-P	92-10-062	415-115-080	AMD-P	92-12-048
392-153-032	AMD-P	92-15-123	392-163-565	NEW-P	92-10-062	415-115-110	REP-E	92-11-027
392-163-105	AMD-P	92-10-062	392-163-570	NEW-P	92-10-062	415-115-110	REP-P	92-12-048
392-163-110	AMD-P	92-10-062	392-163-575	NEW-P	92-10-062	434-08-060	NEW-P	92-15-141
392-163-115	AMD-P	92-10-062	392-163-580	NEW-P	92-10-062	434-08-070	NEW-P	92-15-141
392-163-120	AMD-P	92-10-062	392-163-585	NEW-P	92-10-062	434-08-080	NEW-P	92-15-141
392-163-125	AMD-P	92-10-062	392-163-590	NEW-P	92-10-062	434-08-090	NEW-P	92-15-141
392-163-130	AMD-P	92-10-062	392-163-595	NEW-P	92-10-062	434-28-012	AMD-S	92-09-112
392-163-135	AMD-P	92-10-062	392-163-600	NEW-P	92-10-062	434-28-012	AMD	92-12-083
392-163-140	AMD-P	92-10-062	392-163-605	NEW-P	92-10-062	434-28-020	AMD-S	92-09-112
392-163-145	AMD-P	92-10-062	392-163-610	NEW-P	92-10-062	434-28-020	AMD	92-12-083
392-163-150	NEW-P	92-10-062	392-163-615	NEW-P	92-10-062	434-28-050	NEW-S	92-09-112
392-163-155	NEW-P	92-10-062	392-163-620	NEW-P	92-10-062	434-28-050	NEW	92-12-083
392-163-160	NEW-P	92-10-062	392-163-625	NEW-P	92-10-062	434-28-060	NEW-S	92-09-112
392-163-165	NEW-P	92-10-062	392-163-630	NEW-P	92-10-062	434-28-060	NEW	92-12-083
392-163-170	AMD-P	92-10-062	392-163-635	NEW-P	92-10-062	434-30-010	NEW	92-10-038
392-163-175	AMD-P	92-10-062	392-163-640	NEW-P	92-10-062	434-30-020	NEW	92-10-038
392-163-180	AMD-P	92-10-062	392-163-645	NEW-P	92-10-062	434-30-030	NEW	92-10-038
392-163-185	AMD-P	92-10-062	392-165-105	AMD-P	92-11-028	434-30-040	NEW	92-10-038
392-163-190	AMD-P	92-10-062	392-165-115	AMD-P	92-11-028	434-30-050	NEW	92-10-038
392-163-195	AMD-P	92-10-062	392-165-120	AMD-P	92-11-028	434-30-060	NEW	92-10-038
392-163-200	AMD-P	92-10-062	392-165-130	AMD-P	92-11-028	434-30-070	NEW	92-10-038
392-163-205	AMD-P	92-10-062	392-165-170	AMD-P	92-11-028	434-30-080	NEW	92-10-038
392-163-210	AMD-P	92-10-062	392-165-240	REP-P	92-11-028	434-30-090	NEW	92-10-038
392-163-215	AMD-P	92-10-062	392-165-260	AMD-P	92-11-028	434-30-100	NEW	92-10-038
392-163-220	AMD-P	92-10-062	392-165-304	AMD-P	92-11-028	434-30-110	NEW	92-10-038
392-163-225	AMD-P	92-10-062	392-165-310	AMD-P	92-11-028	434-30-120	NEW	92-10-038
392-163-230	AMD-P	92-10-062	392-165-320	AMD-P	92-11-028	434-30-130	NEW	92-10-038
392-163-235	AMD-P	92-10-062	392-165-322	AMD-P	92-11-028	434-30-140	NEW	92-10-038
392-163-240	AMD-P	92-10-062	392-165-325	AMD-P	92-11-028	434-30-150	NEW	92-10-038
392-163-245	AMD-P	92-10-062	392-165-327	REP-P	92-11-028	434-30-160	NEW	92-10-038
392-163-250	AMD-P	92-10-062	392-165-330	AMD-P	92-11-028	434-30-170	NEW	92-10-038
392-163-255	AMD-P	92-10-062	392-165-332	REP-P	92-11-028	434-30-180	NEW	92-10-038
392-163-260	AMD-P	92-10-062	392-165-340	AMD-P	92-11-028	434-30-190	NEW	92-10-038
392-163-265	AMD-P	92-10-062	392-165-342	REP-P	92-11-028	434-30-200	NEW	92-10-038
392-163-270	AMD-P	92-10-062	392-165-345	AMD-P	92-11-028	434-30-210	NEW	92-10-038
392-163-275	AMD-P	92-10-062	392-165-347	NEW-P	92-11-028	434-30-220	NEW	92-10-038
392-163-280	AMD-P	92-10-062	392-165-360	AMD-P	92-11-028	434-34-010	NEW-S	92-09-112
392-163-285	NEW-P	92-10-062	392-165-362	NEW-P	92-11-028	434-34-010	NEW	92-12-083
392-163-290	NEW-P	92-10-062	392-165-415	NEW-P	92-11-028	434-34-015	NEW-S	92-09-112
392-163-295	NEW-P	92-10-062	392-165-420	NEW-P	92-11-028	434-34-015	NEW	92-12-083
392-163-300	AMD-P	92-10-062	392-165-425	AMD-P	92-11-028	434-34-020	NEW-S	92-09-112
392-163-305	AMD-P	92-10-062	392-165-430	AMD-P	92-11-028	434-34-020	NEW	92-12-083
392-163-310	AMD-P	92-10-062	392-165-460	AMD-P	92-11-028	434-34-025	NEW-S	92-09-112
392-163-315	AMD-P	92-10-062	392-165-500	AMD-P	92-11-028	434-34-025	NEW	92-12-083
392-163-320	AMD-P	92-10-062	392-165-510	NEW-P	92-11-028	434-34-030	NEW-S	92-09-112
392-163-325	AMD-P	92-10-062	392-175-001	NEW-P	92-06-053	434-34-030	NEW	92-12-083
392-163-400	AMD-P	92-10-062	392-175-001	NEW	92-15-071	434-34-035	NEW-S	92-09-112
392-163-405	AMD-P	92-10-062	392-175-005	NEW-P	92-06-053	434-34-035	NEW	92-12-083
392-163-410	AMD-P	92-10-062	392-175-005	NEW	92-15-071	434-34-040	NEW-S	92-09-112
392-163-415	AMD-P	92-10-062	392-175-010	NEW-P	92-06-053	434-34-040	NEW	92-12-083
392-163-420	AMD-P	92-10-062	392-175-010	NEW	92-15-071	434-34-045	NEW-S	92-09-112
392-163-425	AMD-P	92-10-062	392-175-015	NEW-P	92-06-053	434-34-045	NEW	92-12-083
392-163-440	AMD-P	92-10-062	392-175-015	NEW	92-15-071	434-34-050	NEW-S	92-09-112

Table of WAC Sections Affected

WAC #	WSR #	WAC #	WSR #	WAC #	WSR #			
434-34-050	NEW	92-12-083	434-53-250	NEW	92-12-083	434-166-130	NEW	92-10-023
434-34-055	NEW-S	92-09-112	434-53-260	NEW-S	92-09-112	434-166-140	NEW-E	92-02-103
434-34-055	NEW	92-12-083	434-53-260	NEW	92-12-083	434-166-140	NEW-P	92-02-104
434-34-060	NEW-S	92-09-112	434-53-270	NEW-S	92-09-112	434-166-140	NEW	92-10-023
434-34-060	NEW	92-12-083	434-53-270	NEW	92-12-083	434-166-150	NEW-E	92-02-103
434-34-065	NEW-S	92-09-112	434-53-280	NEW-S	92-09-112	434-166-150	NEW-P	92-02-104
434-34-065	NEW	92-12-083	434-53-280	NEW	92-12-083	434-166-150	NEW	92-10-023
434-34-070	NEW-S	92-09-112	434-53-290	NEW-S	92-09-112	434-166-160	NEW-E	92-02-103
434-34-070	NEW	92-12-083	434-53-290	NEW	92-12-083	434-166-160	NEW-P	92-02-104
434-34-075	NEW-S	92-09-112	434-53-300	NEW-S	92-09-112	434-166-160	NEW	92-10-023
434-34-075	NEW	92-12-083	434-53-300	NEW	92-12-083	434-166-170	NEW-E	92-02-103
434-34-080	NEW-S	92-09-112	434-53-310	NEW-S	92-09-112	434-166-170	NEW-P	92-02-104
434-34-080	NEW	92-12-083	434-53-310	NEW	92-12-083	434-166-170	NEW	92-10-023
434-34-085	NEW-S	92-09-112	434-53-320	NEW-S	92-09-112	434-166-180	NEW-E	92-02-103
434-34-085	NEW	92-12-083	434-53-320	NEW	92-12-083	434-166-180	NEW-P	92-02-104
434-34-090	NEW-S	92-09-112	434-53-330	NEW-W	92-12-076	434-166-180	NEW	92-10-023
434-34-090	NEW	92-12-083	434-53-340	NEW-W	92-12-076	434-166-190	NEW-E	92-02-103
434-34-095	NEW-S	92-09-112	434-61-010	NEW	92-10-038	434-166-190	NEW-P	92-02-104
434-34-095	NEW	92-12-083	434-61-020	NEW	92-10-038	434-166-190	NEW	92-10-023
434-34-100	NEW-S	92-09-112	434-61-030	NEW	92-10-038	434-166-200	NEW-E	92-02-103
434-34-100	NEW	92-12-083	434-61-040	NEW	92-10-038	434-166-200	NEW-P	92-02-104
434-34-105	NEW-S	92-09-112	434-61-050	NEW	92-10-038	434-166-200	NEW	92-10-023
434-34-105	NEW	92-12-083	434-61-060	NEW	92-10-038	434-166-210	NEW-E	92-02-103
434-34-110	NEW-S	92-09-112	434-62-150	NEW-S	92-09-112	434-166-210	NEW-P	92-02-104
434-34-110	NEW	92-12-083	434-62-150	NEW	92-12-083	434-166-210	NEW	92-10-023
434-34-115	NEW-S	92-09-112	434-62-160	NEW-S	92-09-112	434-166-220	NEW-E	92-02-103
434-34-115	NEW	92-12-083	434-62-160	NEW	92-12-083	434-166-220	NEW-P	92-02-104
434-40-025	NEW-P	92-15-140	434-62-170	NEW-S	92-09-112	434-166-220	NEW	92-10-023
434-53-010	NEW-S	92-09-112	434-62-170	NEW	92-12-083	434-166-230	NEW-E	92-02-103
434-53-010	NEW	92-12-083	434-62-180	NEW-S	92-09-112	434-166-230	NEW-P	92-02-104
434-53-020	NEW-S	92-09-112	434-62-180	NEW	92-12-083	434-166-230	NEW	92-10-023
434-53-020	NEW	92-12-083	434-62-190	NEW-S	92-09-112	434-166-240	NEW-E	92-02-103
434-53-030	NEW-S	92-09-112	434-62-190	NEW	92-12-083	434-166-240	NEW-P	92-02-104
434-53-030	NEW	92-12-083	434-62-200	NEW-S	92-09-112	434-166-240	NEW	92-10-023
434-53-040	NEW-S	92-09-112	434-62-200	NEW	92-12-083	434-166-250	NEW-E	92-02-103
434-53-040	NEW	92-12-083	434-75-240	AMD-P	92-05-023	434-166-250	NEW-P	92-02-104
434-53-050	NEW-S	92-09-112	434-75-240	AMD	92-08-032	434-166-250	NEW	92-10-023
434-53-050	NEW	92-12-083	434-75-250	AMD-P	92-05-023	434-166-260	NEW-E	92-02-103
434-53-060	NEW-S	92-09-112	434-75-250	AMD	92-08-032	434-166-260	NEW-P	92-02-104
434-53-060	NEW	92-12-083	434-166-010	NEW-E	92-02-103	434-166-260	NEW	92-10-023
434-53-070	NEW-S	92-09-112	434-166-010	NEW-P	92-02-104	434-166-270	NEW-E	92-02-103
434-53-070	NEW	92-12-083	434-166-010	NEW	92-10-023	434-166-270	NEW-P	92-02-104
434-53-080	NEW-S	92-09-112	434-166-020	NEW-E	92-02-103	434-166-270	NEW	92-10-023
434-53-080	NEW	92-12-083	434-166-020	NEW-P	92-02-104	434-166-280	NEW-E	92-02-103
434-53-090	NEW-S	92-09-112	434-166-020	NEW	92-10-023	434-166-280	NEW-P	92-02-104
434-53-090	NEW	92-12-083	434-166-030	NEW-E	92-02-103	434-166-280	NEW	92-10-023
434-53-100	NEW-S	92-09-112	434-166-030	NEW-P	92-02-104	434-166-290	NEW-E	92-02-103
434-53-100	NEW	92-12-083	434-166-030	NEW	92-10-023	434-166-290	NEW-P	92-02-104
434-53-110	NEW-S	92-09-112	434-166-040	NEW-E	92-02-103	434-166-290	NEW	92-10-023
434-53-110	NEW	92-12-083	434-166-040	NEW-P	92-02-104	434-166-300	NEW-E	92-02-103
434-53-120	NEW-S	92-09-112	434-166-040	NEW	92-10-023	434-166-300	NEW-P	92-02-104
434-53-120	NEW	92-12-083	434-166-050	NEW-E	92-02-103	434-166-300	NEW	92-10-023
434-53-130	NEW-S	92-09-112	434-166-050	NEW-P	92-02-104	434-166-310	NEW-E	92-02-103
434-53-130	NEW	92-12-083	434-166-050	NEW	92-10-023	434-166-310	NEW-P	92-02-104
434-53-140	NEW-S	92-09-112	434-166-060	NEW-E	92-02-103	434-166-310	NEW	92-10-023
434-53-140	NEW	92-12-083	434-166-060	NEW-P	92-02-104	434-166-320	NEW-E	92-02-103
434-53-150	NEW-S	92-09-112	434-166-060	NEW	92-10-023	434-166-320	NEW-P	92-02-104
434-53-150	NEW	92-12-083	434-166-070	NEW-E	92-02-103	434-166-320	NEW	92-10-023
434-53-160	NEW-S	92-09-112	434-166-070	NEW-P	92-02-104	434-166-330	NEW-E	92-02-103
434-53-160	NEW	92-12-083	434-166-070	NEW	92-10-023	434-166-330	NEW-P	92-02-104
434-53-170	NEW-S	92-09-112	434-166-080	NEW-E	92-02-103	434-166-330	NEW	92-10-023
434-53-170	NEW	92-12-083	434-166-080	NEW-P	92-02-104	434-166-340	NEW-E	92-02-103
434-53-180	NEW-S	92-09-112	434-166-080	NEW	92-10-023	434-166-340	NEW-P	92-02-104
434-53-180	NEW	92-12-083	434-166-090	NEW-E	92-02-103	434-166-340	NEW	92-10-023
434-53-190	NEW-S	92-09-112	434-166-090	NEW-P	92-02-104	434-166-350	NEW-E	92-02-103
434-53-190	NEW	92-12-083	434-166-090	NEW	92-10-023	434-166-350	NEW-P	92-02-104
434-53-200	NEW-S	92-09-112	434-166-100	NEW-E	92-02-103	434-166-350	NEW	92-10-023
434-53-200	NEW	92-12-083	434-166-100	NEW-P	92-02-104	434-166-360	NEW-E	92-02-103
434-53-210	NEW-S	92-09-112	434-166-100	NEW	92-10-023	434-166-360	NEW-P	92-02-104
434-53-210	NEW	92-12-083	434-166-110	NEW-E	92-02-103	434-166-360	NEW-W	92-15-070
434-53-220	NEW-S	92-09-112	434-166-110	NEW-P	92-02-104	434-630-010	NEW-P	92-09-017
434-53-220	NEW	92-12-083	434-166-110	NEW	92-10-023	434-630-020	NEW-P	92-09-017
434-53-230	NEW-S	92-09-112	434-166-120	NEW-E	92-02-103	434-630-030	NEW-P	92-09-017
434-53-230	NEW	92-12-083	434-166-120	NEW-P	92-02-104	434-630-040	NEW-P	92-09-017
434-53-240	NEW-S	92-09-112	434-166-120	NEW	92-10-023	434-630-050	NEW-P	92-09-017
434-53-240	NEW	92-12-083	434-166-130	NEW-E	92-02-103	434-630-060	NEW-P	92-09-017
434-53-250	NEW-S	92-09-112	434-166-130	NEW-P	92-02-104	434-635-010	NEW-P	92-09-018

Table of WAC Sections Affected

WAC #	WSR #	WAC #	WSR #	WAC #	WSR #			
434-635-020	NEW-P	92-09-018	458-20-230	PREP	92-15-045	463-42-165	AMD-P	92-02-099
434-635-030	NEW-P	92-09-018	458-20-260	NEW-E	92-04-015	463-42-165	AMD	92-09-013
434-635-040	NEW-P	92-09-018	458-20-260	PREP	92-05-052	463-42-195	AMD-P	92-02-099
434-635-050	NEW-P	92-09-018	458-20-260	NEW-P	92-07-092	463-42-195	AMD	92-09-013
434-635-060	NEW-P	92-09-018	458-20-260	NEW	92-10-006	463-42-225	AMD-P	92-02-099
434-640-010	NEW	92-05-060	458-30-262	AMD	92-03-068	463-42-225	AMD	92-09-013
434-640-020	NEW	92-05-060	458-40-615	NEW-E	92-08-018	463-42-265	AMD-P	92-02-099
434-640-030	NEW	92-05-060	458-40-615	PREP	92-10-060	463-42-265	AMD	92-09-013
434-677-010	NEW-P	92-04-026	458-40-615	NEW-E	92-14-111	463-42-345	AMD-P	92-02-099
434-677-010	NEW	92-08-020	458-40-615	NEW-P	92-14-112	463-42-345	AMD	92-09-013
434-677-020	NEW-P	92-04-026	458-40-650	AMD-E	92-06-040	463-42-445	AMD-P	92-02-099
434-677-020	NEW	92-08-020	458-40-650	AMD-E	92-06-057	463-42-445	AMD	92-09-013
434-677-030	NEW-P	92-04-026	458-40-650	AMD-P	92-10-061	463-42-455	AMD-P	92-02-099
434-677-030	NEW	92-08-020	458-40-650	AMD	92-14-083	463-42-455	AMD	92-09-013
434-677-040	NEW-P	92-04-026	458-40-660	PREP	92-10-061	463-42-465	AMD-P	92-02-099
434-677-040	NEW	92-08-020	458-40-660	AMD-E	92-06-040	463-42-465	AMD	92-09-013
434-677-050	NEW-P	92-04-026	458-40-660	AMD-E	92-06-057	463-42-595	AMD-P	92-02-099
434-677-050	NEW	92-08-020	458-40-660	AMD-P	92-10-061	463-42-595	AMD	92-09-013
434-677-060	NEW-P	92-04-026	458-40-660	AMD	92-14-083	463-42-625	AMD-P	92-02-099
434-677-060	NEW	92-08-020	458-40-670	PREP	92-06-037	463-42-625	AMD	92-09-013
434-677-070	NEW-P	92-04-026	458-40-670	AMD-E	92-06-040	463-42-685	NEW-P	92-02-099
434-677-070	NEW	92-08-020	458-40-670	AMD-E	92-06-057	463-42-685	NEW-P	92-06-070
434-677-080	NEW-P	92-04-026	458-40-670	AMD-P	92-10-061	463-42-685	NEW-W	92-07-002
434-677-080	NEW	92-08-020	458-40-670	AMD	92-14-083	463-42-685	NEW	92-10-001
446-16	PREP	92-13-012A	458-40-684	AMD-P	92-10-061	463-42-690	NEW-P	92-02-099
446-16-025	AMD-P	92-11-051	458-40-684	AMD	92-14-083	463-42-690	NEW	92-09-013
446-16-025	AMD	92-15-014	460-33A-015	AMD-P	92-14-089	463-47-051	AMD-P	92-02-099
446-16-030	AMD-P	92-11-051	460-33A-017	AMD-P	92-14-089	463-47-051	AMD	92-09-013
446-16-030	AMD	92-15-014	460-33A-020	AMD-P	92-14-089	463-47-090	AMD-P	92-02-099
446-16-080	AMD-P	92-11-051	460-33A-025	AMD-P	92-14-089	463-47-090	AMD	92-09-013
446-16-080	AMD	92-15-014	460-33A-030	AMD-P	92-14-089	468-51-010	NEW-P	92-10-041
446-16-090	AMD-P	92-11-051	460-33A-035	AMD-P	92-14-089	468-51-010	NEW	92-14-044
446-16-090	AMD	92-15-014	460-33A-040	AMD-P	92-14-089	468-51-020	NEW-P	92-10-041
446-20-285	AMD-P	92-11-052	460-33A-050	REP-P	92-14-089	468-51-020	NEW	92-14-044
446-20-285	AMD	92-15-015	460-33A-055	AMD-P	92-14-089	468-51-030	NEW-P	92-10-041
446-20-290	AMD-P	92-11-052	460-33A-105	AMD-P	92-14-089	468-51-030	NEW	92-14-044
446-20-290	AMD	92-15-015	460-33A-115	AMD-P	92-14-089	468-51-040	NEW-P	92-10-041
446-20-300	AMD-P	92-11-052	460-33A-125	AMD-P	92-14-089	468-51-040	NEW	92-14-044
446-20-300	AMD	92-15-015	460-44A-075	AMD-P	92-14-090	468-51-050	NEW-P	92-10-041
446-20-420	AMD-P	92-11-052	463-06-020	AMD-P	92-02-099	468-51-050	NEW	92-14-044
446-20-420	AMD	92-15-015	463-06-020	AMD	92-09-013	468-51-060	NEW-P	92-10-041
446-20-440	AMD-P	92-11-052	463-06-030	AMD-P	92-02-099	468-51-060	NEW	92-14-044
446-20-440	AMD	92-15-015	463-06-030	AMD	92-09-013	468-51-070	NEW-P	92-10-041
446-20-520	AMD-P	92-11-052	463-06-040	AMD-P	92-02-099	468-51-070	NEW	92-14-044
446-20-520	AMD	92-15-015	463-06-040	AMD	92-09-013	468-51-080	NEW-P	92-10-041
446-30	PREP	92-13-012A	463-06-050	AMD-P	92-02-099	468-51-080	NEW	92-14-044
446-50	PREP	92-13-012A	463-06-050	AMD	92-09-013	468-51-090	NEW-P	92-10-041
458-16-013	PREP	92-04-069	463-06-070	AMD-P	92-02-099	468-51-090	NEW	92-14-044
458-16-013	AMD-P	92-04-079	463-06-070	AMD	92-09-013	468-51-100	NEW-P	92-10-041
458-16-013	AMD-E	92-06-039	463-06-150	AMD-P	92-02-099	468-51-100	NEW	92-14-044
458-16-013	AMD	92-15-058	463-06-150	AMD	92-09-013	468-51-110	NEW-P	92-10-041
458-16-020	PREP	92-04-069	463-26-030	REP-P	92-02-099	468-51-110	NEW	92-14-044
458-16-020	AMD-P	92-04-079	463-26-030	REP	92-09-013	468-51-120	NEW-P	92-10-041
458-16-020	AMD-E	92-06-039	463-39-005	NEW-P	92-02-099	468-51-120	NEW	92-14-044
458-16-020	AMD	92-15-058	463-39-005	NEW	92-09-013	468-51-130	NEW-P	92-10-041
458-18-010	PREP	92-04-068	463-39-010	AMD-P	92-02-099	468-51-130	NEW	92-14-044
458-18-010	AMD-P	92-04-078	463-39-010	AMD	92-09-013	468-51-140	NEW-P	92-10-041
458-18-010	AMD-E	92-06-038	463-39-030	AMD-P	92-02-099	468-51-140	NEW	92-14-044
458-18-010	AMD	92-15-057	463-39-030	AMD	92-09-013	468-51-150	NEW-P	92-10-041
458-18-020	PREP	92-04-068	463-39-040	REP-P	92-02-099	468-51-150	NEW	92-14-044
458-18-020	AMD-P	92-04-078	463-39-040	REP	92-09-013	468-66-010	AMD-P	92-06-010
458-18-020	AMD-E	92-06-038	463-39-050	REP-P	92-02-099	468-66-010	AMD	92-09-043
458-18-220	AMD-P	92-14-086	463-39-050	REP	92-09-013	468-66-090	AMD-P	92-06-010
458-18-020	AMD	92-15-057	463-39-060	REP-P	92-02-099	468-66-090	AMD	92-09-043
458-20-105	AMD-P	92-03-066	463-39-060	REP	92-09-013	468-66-140	AMD-P	92-06-010
458-20-105	AMD	92-06-082	463-39-080	REP-P	92-02-099	468-66-140	AMD	92-09-043
458-20-132	AMD	92-05-066	463-39-080	REP	92-09-013	468-300-010	AMD-P	92-14-003
458-20-164	AMD-P	92-03-067	463-39-110	REP-P	92-02-099	468-300-010	AMD-E	92-14-004
458-20-164	AMD-C	92-15-147A	463-39-110	REP	92-09-013	468-300-020	AMD-P	92-14-003
458-20-166	AMD	92-05-064	463-39-115	AMD-P	92-02-099	468-300-020	AMD-E	92-14-004
458-20-17901	PREP	92-15-044	463-39-115	AMD	92-09-013	468-300-040	AMD-P	92-14-003
458-20-18601	NEW-P	92-03-065	463-39-120	AMD-P	92-02-099	468-300-040	AMD-E	92-14-004
458-20-18601	NEW	92-06-081	463-39-120	AMD	92-09-013	468-300-070	REP-P	92-14-003
458-20-18801	AMD	92-05-065	463-39-150	REP-P	92-02-099	468-300-070	REP-E	92-14-004
458-20-199	AMD	92-03-026	463-39-150	REP	92-09-013	468-300-410	REP-P	92-14-003
458-20-228	AMD	92-03-025	463-42-055	AMD-P	92-02-099	468-300-410	REP-E	92-14-004
458-20-229	AMD-P	92-05-017	463-42-055	AMD	92-09-013	468-300-510	REP-P	92-14-003

Table of WAC Sections Affected

WAC #	WSR #	WAC #	WSR #	WAC #	WSR #			
468-300-510	REP-E	92-14-004	478-160-256	AMD-P	92-08-065	480-93-015	NEW-P	92-06-086
478-138-010	AMD-P	92-09-154	478-160-256	AMD	92-12-011	480-93-017	NEW-P	92-06-086
478-138-010	AMD	92-14-060	478-160-260	AMD-P	92-08-065	480-93-018	NEW-P	92-06-086
478-138-020	AMD-P	92-09-154	478-160-260	AMD	92-12-011	480-93-020	AMD-P	92-06-086
478-138-020	AMD	92-14-060	478-160-265	AMD-P	92-08-065	480-93-030	AMD-P	92-06-086
478-138-030	AMD-P	92-09-154	478-160-265	AMD	92-12-011	480-93-082	NEW-P	92-06-086
478-138-030	AMD	92-14-060	478-160-270	AMD-P	92-08-065	480-93-110	AMD-P	92-06-086
478-138-040	AMD-P	92-09-154	478-160-270	AMD	92-12-011	480-93-111	NEW-P	92-06-086
478-138-040	AMD	92-14-060	478-160-271	NEW-P	92-08-065	480-93-112	NEW-P	92-06-086
478-138-050	REP-P	92-09-154	478-160-271	NEW	92-12-011	480-93-115	NEW-P	92-06-086
478-138-050	REP	92-14-060	478-160-275	AMD-P	92-08-065	480-93-120	AMD-P	92-06-086
478-138-060	NEW-P	92-09-154	478-160-275	AMD	92-12-011	480-93-124	NEW-P	92-06-086
478-138-060	NEW	92-14-060	478-160-280	AMD-P	92-08-065	480-93-140	AMD-P	92-06-086
478-160-020	AMD-P	92-08-065	478-160-280	AMD	92-12-011	480-93-155	NEW-P	92-06-086
478-160-020	AMD	92-12-011	478-160-285	AMD-P	92-08-065	480-93-161	NEW-P	92-06-086
478-160-025	AMD-P	92-08-065	478-160-285	AMD	92-12-011	480-93-175	NEW-P	92-06-086
478-160-025	AMD	92-12-011	478-160-290	AMD-P	92-08-065	480-93-180	AMD-P	92-06-086
478-160-030	AMD-P	92-08-065	478-160-290	AMD	92-12-011	480-93-183	NEW-P	92-06-086
478-160-030	AMD	92-12-011	478-160-295	AMD-P	92-08-065	480-93-185	AMD-P	92-06-086
478-160-035	AMD-P	92-08-065	478-160-295	AMD	92-12-011	480-93-18601	AMD-P	92-06-086
478-160-035	AMD	92-12-011	478-160-305	AMD-P	92-08-065	480-93-187	AMD-P	92-06-086
478-160-040	AMD-P	92-08-065	478-160-305	AMD	92-12-011	480-93-188	AMD-P	92-06-086
478-160-040	AMD	92-12-011	478-160-310	AMD-P	92-08-065	480-93-190	AMD-P	92-06-086
478-160-045	AMD-P	92-08-065	478-160-310	AMD	92-12-011	480-93-200	AMD-P	92-06-086
478-160-045	AMD	92-12-011	478-160-320	AMD-P	92-08-065	480-93-210	AMD-P	92-06-086
478-160-050	AMD-P	92-08-065	478-160-320	AMD	92-12-011	480-93-230	AMD-P	92-06-086
478-160-050	AMD	92-12-011	479-01-020	AMD-P	92-08-095	480-110-018	NEW-P	92-05-091
478-160-055	AMD-P	92-08-065	479-01-020	AMD	92-12-014	480-110-018	NEW	92-09-078
478-160-055	AMD	92-12-011	480-04-010	REP	92-07-006	480-110-021	AMD-P	92-05-090
478-160-060	AMD-P	92-08-065	480-04-020	AMD	92-07-006	480-110-021	AMD	92-13-056
478-160-060	AMD	92-12-011	480-04-030	AMD	92-07-006	480-110-066	AMD-P	92-05-090
478-160-065	AMD-P	92-08-065	480-04-040	REP	92-07-006	480-110-066	AMD	92-13-056
478-160-065	AMD	92-12-011	480-04-050	AMD	92-07-006	480-120-087	AMD-P	92-13-101
478-160-085	AMD-P	92-08-065	480-04-060	AMD	92-07-006	480-120-340	NEW	92-03-049
478-160-085	AMD	92-12-011	480-04-065	NEW	92-07-006	480-146-091	NEW-C	92-05-001
478-160-090	REP-P	92-08-065	480-04-070	AMD	92-07-006	480-146-091	NEW	92-07-009
478-160-090	REP	92-12-011	480-04-080	REP	92-07-006	484-10-035	AMD-P	92-13-022
478-160-105	AMD-P	92-08-065	480-04-090	AMD	92-07-006	484-20-010	AMD-P	92-13-023
478-160-105	AMD	92-12-011	480-04-095	NEW	92-07-006	484-20-015	AMD-P	92-13-023
478-160-115	AMD-P	92-08-065	480-04-110	AMD	92-07-006	484-20-020	AMD-P	92-13-023
478-160-115	AMD	92-12-011	480-04-120	AMD	92-07-006	484-20-023	NEW-P	92-13-023
478-160-120	AMD-P	92-08-065	480-04-130	AMD	92-07-006	484-20-025	AMD-P	92-13-023
478-160-120	AMD	92-12-011	480-09-100	AMD	92-07-006	484-20-030	AMD-P	92-13-023
478-160-130	AMD-P	92-08-065	480-09-140	AMD-P	92-13-101	484-20-035	AMD-P	92-13-023
478-160-130	AMD	92-12-011	480-09-210	AMD	92-07-006	484-20-040	AMD-P	92-13-023
478-160-140	AMD-P	92-08-065	480-09-210	AMD-P	92-13-101	484-20-045	AMD-P	92-13-023
478-160-140	AMD	92-12-011	480-09-400	AMD-P	92-13-101	484-20-050	AMD-P	92-13-023
478-160-150	AMD-P	92-08-065	480-09-420	AMD-P	92-13-101	484-20-055	AMD-P	92-13-023
478-160-150	AMD	92-12-011	480-09-425	AMD-P	92-13-101	484-20-060	AMD-P	92-13-023
478-160-155	REP-P	92-08-065	480-09-460	AMD-P	92-13-101	484-20-065	AMD-P	92-13-023
478-160-155	REP	92-12-011	480-09-480	AMD-P	92-13-101	484-20-068	AMD-P	92-13-023
478-160-160	AMD-P	92-08-065	480-09-500	AMD-P	92-13-101	484-20-070	AMD-P	92-13-023
478-160-160	AMD	92-12-011	480-09-700	AMD-P	92-13-101	484-20-075	AMD-P	92-13-023
478-160-200	REP-P	92-08-065	480-09-735	AMD-P	92-13-101	484-20-085	AMD-P	92-13-023
478-160-200	REP	92-12-011	480-09-780	AMD-P	92-13-101	484-20-087	NEW-P	92-13-023
478-160-205	REP-P	92-08-065	480-09-800	AMD-P	92-13-101	484-20-089	NEW-P	92-13-023
478-160-205	REP	92-12-011	480-09-810	AMD-P	92-13-101	484-20-090	AMD-P	92-13-023
478-160-210	AMD-P	92-08-065	480-12-375	AMD-P	92-05-092	484-20-095	AMD-P	92-13-023
478-160-210	AMD	92-12-011	480-12-375	AMD	92-09-014	484-20-100	AMD-P	92-13-023
478-160-215	REP-P	92-08-065	480-70-350	AMD	92-03-082	484-20-105	AMD-P	92-13-023
478-160-215	REP	92-12-011	480-80-047	AMD-W	92-10-067	484-20-110	AMD-P	92-13-023
478-160-216	REP-P	92-08-065	480-80-048	NEW	92-07-010	484-20-115	AMD-P	92-13-023
478-160-216	REP	92-12-011	480-80-049	NEW-P	92-05-089	484-20-120	AMD-P	92-13-023
478-160-220	REP-P	92-08-065	480-80-049	NEW	92-08-075	484-20-135	AMD-P	92-13-023
478-160-220	REP	92-12-011	480-92-011	NEW	92-03-050	484-20-140	AMD-P	92-13-023
478-160-225	REP-P	92-08-065	480-92-021	NEW	92-03-050	484-20-145	AMD-P	92-13-023
478-160-225	REP	92-12-011	480-92-031	NEW	92-03-050	484-20-150	AMD-P	92-13-023
478-160-230	AMD-P	92-08-065	480-92-050	NEW	92-03-050	495A-104-010	NEW-P	92-07-101
478-160-230	AMD	92-12-011	480-92-060	NEW	92-03-050	495A-104-010	NEW-E	92-08-004
478-160-231	AMD-P	92-08-065	480-92-070	NEW	92-03-050	495A-104-010	NEW	92-12-017
478-160-231	AMD	92-12-011	480-92-080	NEW	92-03-050	495A-104-020	NEW-P	92-07-101
478-160-232	REP-P	92-08-065	480-92-090	NEW	92-03-050	495A-104-020	NEW-E	92-08-004
478-160-232	REP	92-12-011	480-92-100	NEW	92-03-050	495A-104-020	NEW	92-12-017
478-160-240	AMD-P	92-08-065	480-92-110	NEW	92-03-050	495A-104-030	NEW-P	92-07-101
478-160-240	AMD	92-12-011	480-93-002	AMD-P	92-06-086	495A-104-030	NEW-E	92-08-004
478-160-246	AMD-P	92-08-065	480-93-005	AMD-P	92-06-086	495A-104-030	NEW	92-12-017
478-160-246	AMD	92-12-011	480-93-010	AMD-P	92-06-086	495A-108-010	NEW-P	92-07-101









Table of WAC Sections Affected

WAC #	WSR #	WAC #	WSR #	WAC #	WSR #			
495D-120-050	NEW-P	92-12-049	495D-168-020	NEW	92-15-081	508-12-290	REP-P	92-06-091
495D-120-050	NEW	92-15-081	495D-168-030	NEW-P	92-12-049	508-12-290	REP	92-12-055
495D-120-060	NEW-P	92-12-049	495D-168-030	NEW	92-15-081	508-12-300	REP-P	92-06-091
495D-120-060	NEW	92-15-081	495D-168-040	NEW-P	92-12-049	508-12-300	REP	92-12-055
495D-120-070	NEW-P	92-12-049	495D-168-040	NEW	92-15-081	508-12-310	REP-P	92-06-091
495D-120-070	NEW	92-15-081	495D-168-050	NEW-P	92-12-049	508-12-310	REP	92-12-055
495D-120-080	NEW-P	92-12-049	495D-168-050	NEW	92-15-081	508-12-320	REP-P	92-06-091
495D-120-080	NEW	92-15-081	495D-168-060	NEW-P	92-12-049	508-12-320	REP	92-12-055
495D-120-090	NEW-P	92-12-049	495D-168-060	NEW	92-15-081	508-12-330	REP-P	92-06-091
495D-120-090	NEW	92-15-081	495D-276-010	NEW-P	92-12-049	508-12-330	REP	92-12-055
495D-120-100	NEW-P	92-12-049	495D-276-010	NEW	92-15-081	508-12-340	REP-P	92-06-091
495D-120-100	NEW	92-15-081	495D-276-020	NEW-P	92-12-049	508-12-340	REP	92-12-055
495D-120-110	NEW-P	92-12-049	495D-276-020	NEW	92-15-081	508-12-350	REP-P	92-06-091
495D-120-110	NEW	92-15-081	495D-276-030	NEW-P	92-12-049	508-12-350	REP	92-12-055
495D-120-120	NEW-P	92-12-049	495D-276-030	NEW	92-15-081	508-12-360	REP-P	92-06-091
495D-120-120	NEW	92-15-081	495D-276-040	NEW-P	92-12-049	508-12-360	REP	92-12-055
495D-120-130	NEW-P	92-12-049	495D-276-040	NEW	92-15-081	508-12-370	REP-P	92-06-091
495D-120-130	NEW	92-15-081	495D-276-050	NEW-P	92-12-049	508-12-370	REP	92-12-055
495D-120-140	NEW-P	92-12-049	495D-276-050	NEW	92-15-081	508-12-380	REP-P	92-06-091
495D-120-140	NEW	92-15-081	495D-276-060	NEW-P	92-12-049	508-12-380	REP	92-12-055
495D-120-150	NEW-P	92-12-049	495D-276-060	NEW	92-15-081	516-12-400	AMD	92-06-068
495D-120-150	NEW	92-15-081	495D-276-070	NEW-P	92-12-049	516-12-430	AMD	92-06-068
495D-120-160	NEW-P	92-12-049	495D-276-070	NEW	92-15-081	516-13-080	AMD	92-06-068
495D-120-160	NEW	92-15-081	495D-276-080	NEW-P	92-12-049	516-13-090	NEW	92-06-068
495D-120-170	NEW-P	92-12-049	495D-276-080	NEW	92-15-081			
495D-120-170	NEW	92-15-081	495D-276-090	NEW-P	92-12-049			
495D-120-180	NEW-P	92-12-049	495D-276-090	NEW	92-15-081			
495D-120-180	NEW	92-15-081	495D-276-100	NEW-P	92-12-049			
495D-120-190	NEW-P	92-12-049	495D-276-100	NEW	92-15-081			
495D-120-190	NEW	92-15-081	495D-276-110	NEW-P	92-12-049			
495D-120-200	NEW-P	92-12-049	495D-276-110	NEW	92-15-081			
495D-120-200	NEW	92-15-081	495D-276-120	NEW-P	92-12-049			
495D-122-010	NEW-P	92-12-049	495D-276-120	NEW	92-15-081			
495D-122-010	NEW	92-15-081	495D-276-130	NEW-P	92-12-049			
495D-122-020	NEW-P	92-12-049	495D-276-130	NEW	92-15-081			
495D-122-020	NEW	92-15-081	495D-276-140	NEW-P	92-12-049			
495D-122-030	NEW-P	92-12-049	495D-276-140	NEW	92-15-081			
495D-122-030	NEW	92-15-081	495D-280-010	NEW-P	92-12-049			
495D-130-010	NEW-P	92-12-049	495D-280-010	NEW	92-15-081			
495D-130-010	NEW	92-15-081	495D-280-015	NEW-P	92-12-049			
495D-130-015	NEW-P	92-12-049	495D-280-015	NEW	92-15-081			
495D-130-015	NEW	92-15-081	495D-280-020	NEW-P	92-12-049			
495D-130-020	NEW-P	92-12-049	495D-280-020	NEW	92-15-081			
495D-130-020	NEW	92-15-081	495D-280-030	NEW-P	92-12-049			
495D-131-010	NEW-P	92-12-049	495D-280-030	NEW	92-15-081			
495D-131-010	NEW	92-15-081	495D-280-040	NEW-P	92-12-049			
495D-132-010	NEW-P	92-12-049	495D-280-040	NEW	92-15-081			
495D-132-010	NEW	92-15-081	495D-280-050	NEW-P	92-12-049			
495D-133-020	NEW-P	92-12-049	495D-280-050	NEW	92-15-081			
495D-133-020	NEW	92-15-081	495D-280-060	NEW-P	92-12-049			
495D-134-010	NEW-P	92-12-049	495D-280-060	NEW	92-15-081			
495D-134-010	NEW	92-15-081	495D-280-070	NEW-P	92-12-049			
495D-140-010	NEW-P	92-12-049	495D-280-070	NEW	92-15-081			
495D-140-010	NEW	92-15-081	495D-280-080	NEW-P	92-12-049			
495D-140-020	NEW-P	92-12-049	495D-280-080	NEW	92-15-081			
495D-140-020	NEW	92-15-081	495D-280-090	NEW-P	92-12-049			
495D-140-030	NEW-P	92-12-049	495D-280-090	NEW	92-15-081			
495D-140-030	NEW	92-15-081	495D-280-100	NEW-P	92-12-049			
495D-140-040	NEW-P	92-12-049	495D-280-100	NEW	92-15-081			
495D-140-040	NEW	92-15-081	495D-280-110	NEW-P	92-12-049			
495D-140-050	NEW-P	92-12-049	495D-280-110	NEW	92-15-081			
495D-140-050	NEW	92-15-081	495D-280-120	NEW-P	92-12-049			
495D-140-060	NEW-P	92-12-049	495D-280-120	NEW	92-15-081			
495D-140-060	NEW	92-15-081	495D-300-010	NEW-P	92-12-049			
495D-140-070	NEW-P	92-12-049	495D-300-010	NEW	92-15-081			
495D-140-070	NEW	92-15-081	495D-300-015	NEW-P	92-12-049			
495D-140-080	NEW-P	92-12-049	495D-300-015	NEW	92-15-081			
495D-140-080	NEW	92-15-081	495D-300-020	NEW-P	92-12-049			
495D-140-090	NEW-P	92-12-049	495D-300-020	NEW	92-15-081			
495D-140-090	NEW	92-15-081	495D-300-030	NEW-P	92-12-049			
495D-140-100	NEW-P	92-12-049	495D-300-030	NEW	92-15-081			
495D-140-100	NEW	92-15-081	495D-300-040	NEW-P	92-12-049			
495D-140-110	NEW-P	92-12-049	495D-300-040	NEW	92-15-081			
495D-140-110	NEW	92-15-081	495D-325-010	NEW-P	92-12-049			
495D-168-010	NEW-P	92-12-049	495D-325-010	NEW	92-15-081			
495D-168-010	NEW	92-15-081	508-12-280	REP-P	92-06-091			
495D-168-020	NEW-P	92-12-049	508-12-280	REP	92-12-055			

**Subject/Agency Index**  
(Citations in **bold type** refer to material in this issue)

<b>ACCOUNTANCY, BOARD OF</b>		<b>AGRICULTURE, DEPARTMENT OF—cont.</b>	
Experience requirement for license	92-03-062	small quantities sold through fruit stands and farmers' markets inspection requirements, exemption	92-13-064 <b>92-15-117</b>
<b>AGRICULTURE, DEPARTMENT OF</b>		Fryer commission	
Alfalfa		meetings	92-06-026
certification	92-09-150 92-13-027	Grain and commodity inspection points	92-11-073 <b>92-15-046</b>
Annual bluegrass quarantine	92-09-150 92-13-027	Grass	
Apparatus display signs	92-11-077 <b>92-15-001</b>	certification	92-09-150 92-13-027
Apple advertising commission		sod quality standards	92-09-150 92-13-027
meetings	92-01-024	sudangrass certification	92-09-150 92-13-027
Apples		Herbicides	
apple ermine moth quarantine	92-02-071 92-06-024	restrictions	92-08-028
apple maggot survey and detection program		Hop commission	
funds	92-02-069 92-04-032 92-06-022	assessments	92-06-071 92-09-068
grade standards	92-11-074 <b>92-15-056</b>	board member activities	92-06-071 92-09-068
Aquatic and wetland weed quarantine	92-03-105 92-07-024	meetings	92-01-063
Azalea flower spot quarantine	92-09-074 92-13-050	Inspection and/or weighing fees	92-11-073
Bean seed		Landscape applications	
bean seedborne viral disease quarantine	92-06-048 92-06-049 92-06-050 92-09-075 92-12-025 92-09-075	apparatus display signs	92-11-077 <b>92-15-001</b>
certification standards	92-09-075	Livestock markets, public	
Beef commission		brand inspection work area	
meetings	92-03-034 <b>92-15-049</b>	standards	92-01-111 92-06-013
Blueberry commission		Milk	
meetings	92-04-031	processing	
Bulb commission		assessments and collections	92-14-076
meetings	92-01-017	Noxious weed seed and plant quarantine	92-03-106 92-07-025
Caneberries		Nurseries	
certification fees	92-12-056 <b>92-15-114</b>	dealer license fees	92-10-040 92-13-034
Corn		research projects, fee surcharge to support	92-10-040 92-13-034
negotiating session between producers and processors, recordkeeping	92-03-069 92-03-070 92-07-030	Organic foods	
Egg commission		meat and dairy products, production standards	92-07-052 92-11-001
meetings	92-03-123 <b>92-15-053</b>	packers	
Eggs		certification standards	92-13-100
grading and packing facilities, standards	92-01-091	fee schedule	92-13-100
Farmed salmon commission		recordkeeping requirements	92-13-100
assessments and collections	92-14-117	packing facilities	
commodity board	92-14-117	certification standards	92-13-100
establishment	92-14-117	vendors	
marketing order	92-14-117	certification standards	92-13-099
Fees and charges for department services	92-03-104 92-07-023 92-11-073 <b>92-15-046</b>	fee schedule	92-13-099
Food distributors		recordkeeping requirements	92-13-099
licenses	92-07-070	Peaches	
Food processors		grade standards	92-08-106 92-11-076
licenses	92-07-070 <b>92-15-060</b> <b>92-15-061</b>	Pears	
Fruits and vegetables		state restricted use pesticides	
movement from production area		ziram	<b>92-15-026</b>
inspection requirements	92-01-121 92-06-085	Pesticides	
		microencapsulated methyl parathion distribution	<b>92-15-051</b> 92-03-064 92-06-083 92-10-008
		penalty matrix schedule	92-03-134 92-07-005 92-07-059 92-07-060 92-08-026 92-08-027 92-13-035
		restrictions	

## Subject/Agency Index

(Citations in **bold type** refer to material in this issue)

### AGRICULTURE, DEPARTMENT OF—cont.

violations, rights of persons aggrieved by	92-06-084 92-10-009
ziram use on pears	92-15-026
Phytosanitary certification	92-09-150 92-13-027
Potatoes	
negotiating session between producers and processors, recordkeeping	92-03-069 92-03-070 92-07-030
Rapeseed	
off type varieties, registration	92-08-055 92-11-013
Red raspberry commission	
commodity board membership	92-05-070 92-12-003 92-05-070 92-12-003 92-03-007
powers and duties	
meetings	
Seed potato commission	
assessment fees	92-15-107
Seeds	
assessment fees	92-09-150 92-13-027
Strawberries	
plant certification fees	92-12-056
Strawberry commission	
commodity board assessments	92-05-071 92-12-004 92-12-006 92-05-071 92-12-004 92-12-006 92-03-058
term limitations	
meetings	
Tree fruit research commission	
assessment rates	92-01-009
Varroa mite quarantine	92-01-013 92-02-070 92-06-023
Weeds	
aquatic and wetland, quarantine	92-03-105 92-07-024
noxious weed seed and plant quarantine	92-03-106 92-07-025
Weights and measures	
condemned and confiscated weights and measures, disposition	92-14-122 92-14-123 92-14-122 92-14-123
inspection fees	
national type evaluation program	
uniform regulations	92-03-018
weigher license	92-14-122 92-14-123 92-14-122 92-14-123
weighmaster license	
Wetland and aquatic weed quarantine	92-03-105 92-07-024
Wine commission	
meetings	92-02-048 92-09-036
Wood destroying organisms	
inspection and reporting criteria	92-03-133 92-07-084
<b>ASIAN AMERICAN AFFAIRS, COMMISSION ON</b>	
Meetings	92-02-028
Rules coordinator	92-15-124
<b>ATTORNEY GENERAL'S OFFICE</b>	
Motor vehicles	
arbitration special master, powers and duties	92-11-037

### ATTORNEY GENERAL'S OFFICE—cont.

consumer rights notice	92-11-036
lemon law arbitration	92-11-036
subsequent transferee, definition	92-11-037
Opinions	
city ordinances, validity (1992, No. 16)	92-15-126
collection agencies, dishonored check notice (1992, No. 2)	92-06-061
corporal punishment in public schools (1992, No. 10)	92-14-124
county board of equalization, authority (1992, No. 14)	92-15-088
district court judges, salaries and qualifications (1992, No. 13)	92-15-016
district courts, municipal department termination (1992, No. 15)	92-15-125
launch service operations (1992, No. 7)	92-12-039
presumptive death certificate, when authorized (1992, No. 6)	92-12-016
rent control, local government authority to impose (1992, No. 5)	92-10-035
school district real estate purchase (1991, No. 34)	92-02-005
special election in newly redistricted district (1992, No. 12)	92-15-004
substitute care citizen review boards, records (1992, No. 9)	92-13-048
trust requirement, land granted to Washington Territory (1992, No. 3)	92-06-062
water district commissioners and employees, applicability of code of ethics (1992, No. 11)	92-15-003
water district commissioners, insurance benefits (1992, No. 8)	92-13-012 92-13-060
weed control, authority of counties (1991, No. 1)	92-06-051
wildlife regulations (1992, No. 4)	92-07-032
<b>BASIC HEALTH PLAN</b>	
Advisory council	
meetings	92-12-024
Benefits schedules	92-09-157 92-14-087 92-14-097 92-09-157 92-14-087 92-14-097 92-09-157 92-14-087 92-14-097 92-09-157 92-14-088 92-14-097
Disenrollment	
Enrollment	
Premiums and copayments	
<b>BATES TECHNICAL COLLEGE</b>	
Board of trustees	92-07-101 92-08-004 92-12-017
Debts, services withheld for outstanding debts	92-07-101 92-08-004 92-12-017
Discrimination	92-07-101 92-08-004 92-12-017
Facilities use	92-07-101 92-08-004 92-12-017
Financial aid	92-07-101 92-08-004 92-12-017
Grievance procedures	92-07-101 92-08-004 92-12-017
Meetings	92-01-043
Organization and operation	92-07-101 92-08-004 92-12-017



## Subject/Agency Index

(Citations in **bold type** refer to material in this issue)

<b>CLOVER PARK TECHNICAL COLLEGE—cont.</b>		<b>CONVENTION AND TRADE CENTER</b>	
Scholarships	92-12-050	Meetings	92-01-025
State Environmental Policy Act compliance	92-12-050		92-02-078
Student conduct code	92-12-050		92-03-009
Tuition and fee schedule	92-12-050		92-05-063
			92-07-056
<b>CODE REVISER'S OFFICE</b>			92-09-049
Rules coordinator	92-01-001		92-11-029
			92-13-007
<b>COLUMBIA RIVER GORGE COMMISSION</b>			92-13-073
Alterations to existing structures	92-07-057		92-14-059
	92-09-020		<b>92-15-030</b>
Management plan amendment process	92-09-095		
	92-11-005	<b>COUNTY ROAD ADMINISTRATION BOARD</b>	
	<b>92-15-013</b>	Organization and operation	92-08-068
Urban area boundary revision			92-13-036
application procedures	92-05-009	Public records, availability	92-08-069
	92-11-006		92-13-037
		Rules coordinator	92-02-047
<b>COMBINED FUND DRIVE COMMITTEE, WASHINGTON STATE EMPLOYEE (See GOVERNOR, OFFICE OF THE)</b>			92-04-017
<b>COMMUNITY AND TECHNICAL COLLEGES, STATE BOARD FOR</b>		Rural arterial programs	
Course and enrollment information,		design standards	92-08-072
dissemination	92-09-140		92-12-005
	92-13-020	funds allocation	92-08-071
Meetings	92-01-054		92-13-039
Organization and operations	92-09-138	project prioritization	92-08-070
	92-13-019		92-13-038
Retirement plan		<b>CRIMINAL JUSTICE TRAINING COMMISSION</b>	
options for members terminating		Firearms certification	
employment	92-09-139	instructors	92-02-042
	92-12-085	private detectives	92-02-041
Tuition and fees	92-10-033	private security guards	92-02-040
	92-10-042	records	92-02-042
	92-14-033		
<b>COMMUNITY DEVELOPMENT, DEPARTMENT OF</b>		<b>DAIRY PRODUCTS COMMISSION</b>	
Affordable housing program	92-06-005	Assessment rate	92-10-031
Development loan fund			<b>92-15-080</b>
meetings	92-03-081	Promotional hosting expenditures	92-10-032
Energy matchmakers program	92-03-019		92-14-035
Fire protection policy board		<b>DEAF, WASHINGTON STATE SCHOOL FOR THE</b>	
meetings	92-06-014	Rules coordinator	92-01-020
	92-10-003	<b>EASTERN WASHINGTON UNIVERSITY</b>	
Fire protection services		Adjudicative proceedings	92-04-084
state facilities in cities and towns	92-09-146		92-05-053
	92-09-147		92-05-056
	<b>92-15-047</b>		92-09-100
Fire protection sprinkler systems			92-09-102
contractors		Alcoholic beverages	92-09-105
licensing and certification	92-14-073	use by students twenty-one and older	
	92-14-074	in student housing	92-05-054
surety bond	92-14-073		92-09-103
	92-14-074	Commercial activities on campus	<b>92-15-128</b>
Low-income home energy assistance		Employees	
program	92-13-085	assessed financial obligations	92-05-053
Low-income weatherization assistance	92-03-019		92-09-102
Public hearings		paycheck deductions	92-05-053
natural resources of state-wide			92-09-102
significance	92-01-134	General conduct code	<b>92-15-127</b>
Public works board		Library policies	92-14-056
loan and financing guarantees	92-03-052	Meetings	92-02-031
meetings	92-01-108		92-04-085
	92-06-032		92-09-101
Radon monitoring devices	92-14-002	Organization and operation	92-04-083
State Environmental Policy Act compliance	92-03-051		92-09-099
<b>CONSERVATION AND RENEWABLE ENERGY SYSTEM</b>		Recreational equipment restrictions	<b>92-15-129</b>
Meetings	<b>92-15-042</b>	Rules coordinator	92-02-030
			92-04-054
		Scholarships	92-11-024
		State Environmental Policy Act compliance	92-02-052
			92-05-055
		Student records, availability	92-09-104
		Students	92-02-053
		assessed financial obligations	92-05-056
			92-09-105

**Subject/Agency Index**  
(Citations in **bold type** refer to material in this issue)

**ECOLOGY, DEPARTMENT OF**

Air quality	
motor vehicle emission inspection	92-09-133
open burning	92-12-026
oxygenated gasoline standards	92-06-088
	92-11-043
Boatyard permit	92-07-086
Carbon monoxide emissions	
oxygenated gasoline standards	92-06-088
	92-11-043
Chlorofluorocarbon refrigerants	
recycling requirements	92-11-045
Conservation and renewable energy system	
approval of application to form	92-10-044
notice of intention to consider	
application to form	92-06-046
Dairy waste general discharge permit	92-13-090
Dam safety regulations	92-06-091
	92-12-055
Dangerous waste	
spill and discharge reporting	
requirements	92-03-127
	92-11-040
	<b>92-15-036</b>
Forest practices	
aquatic habitat protection	92-07-085
	92-11-068
	92-14-098
classification	92-05-084
water quality protection	92-07-085
	92-11-068
	92-14-098
wetlands protection	92-07-085
	92-11-068
	92-14-098
Hazardous waste	
fees	92-05-083
	92-10-043
water supply to areas contaminated by	
remedial action grants	92-14-072
Instream resources protection program	
Columbia River, main stem	92-14-010
	92-14-012
Mixed waste	
facilities, permit fees	92-10-021
Motor vehicle emission inspection	92-09-133
Motor vehicle fuel	
oxygenated gasoline standards	92-06-088
	92-11-043
Oil spills	
compensation schedule	92-01-095
	92-09-034
	92-10-005
	92-11-038
	92-13-083
facility oil spill prevention plan	
standards	92-06-087
	<b>92-15-035</b>
natural resource damage assessment	92-01-095
	92-09-034
	92-10-005
	92-11-038
	92-13-083
Open burning	
permits	92-12-026
prohibited materials	92-12-026
violations	92-12-026
Organization offices	92-13-049
Pesticide use	92-05-084
Public records	
availability	92-13-049
	<b>92-15-112</b>
fees	92-13-049
	<b>92-15-112</b>
Refrigerants	
recycling requirements	92-11-045

**ECOLOGY, DEPARTMENT OF—cont.**

Rules coordinator	92-01-094
	92-06-047
Rules review	
small business impact	92-11-067
Shoreline master programs	
Bellevue, city of	92-07-090
	92-13-080
Bremerton, city of	92-04-081
Bridgeport, city of	92-03-132
Clallam County	92-07-091
	92-13-081
Island County	92-04-080
	92-09-135
Kent, city of	92-07-087
	92-13-082
Mercer Island, city of	92-03-128
	92-09-131
	92-11-044
Normandy Park, city of	92-01-096
Pateros, city of	92-01-097
Port Orchard, city of	92-03-129
	92-09-127
	92-12-054
	92-13-084
San Juan County	92-11-042
	92-14-120
	<b>92-15-110</b>
Seattle, city of	92-07-088
	92-09-128
	92-13-079
Snoqualmie, city of	92-09-132
Tacoma, city of	<b>92-15-109</b>
Tumwater, city of	92-03-130
	92-09-134
Wahkiakum County	92-07-089
	92-13-078
Whatcom County	<b>92-15-108</b>
Small business impacts	
rules review	92-11-067
Solid fuel burning devices	
masonry fireplaces, retail sales	
fee	92-01-098
	92-09-035
	92-10-022
	<b>92-15-111</b>
	92-01-098
	92-09-035
	92-10-022
retail sales fee	
State/environmental protection	
agency agreement	92-09-054
Storm water permit for industries	
and construction	92-13-070
	92-14-071
Waste	
mixed waste facilities	
permit fees	92-10-021
Wastewater	
dairy waste general discharge	
permit	92-13-090
discharge permit	
fee schedule	92-03-131
Water	
boatyard permit	92-07-086
hazardous waste contamination	
potable water supply to areas	
affected by	92-14-072
storm water permit for industries	
and construction	92-13-070
	92-14-071
surface water quality standards	92-11-041
Water resources management program	
Columbia River main stem	92-14-010
	92-14-012
	92-14-009
Snake River, main stem	92-14-011

**Subject/Agency Index**  
(Citations in **bold type** refer to material in this issue)

<b>ECOLOGY, DEPARTMENT OF—cont.</b>		<b>EMPLOYMENT SECURITY DEPARTMENT</b>	
Water rights		Employer notice and separation	
Columbia River water withdrawal	92-07-055	determination	92-03-145
	92-14-010	Timber impact areas	
	92-14-012	dislocated workers	92-02-076
Snake River water withdrawal	92-07-054		92-05-051
	92-14-009	Unemployment insurance	
	92-14-011	benefit charge relief	92-07-104
Watershed analysis implementation	92-05-084	predecessor/successor relationship	92-07-104
Woodstove regulation	92-01-098		92-14-047
	92-09-035		
	<b>92-15-111</b>	<b>ENERGY FACILITY SITE EVALUATION COUNCIL</b>	
<b>ECONOMIC DEVELOPMENT FINANCE</b>		Air pollution sources	92-02-099
<b>    AUTHORITY</b>			92-07-002
Operations and procedures	92-03-055		92-09-013
	92-03-056	Environmental regulations	92-02-099
	92-09-002		92-07-002
			92-09-013
<b>EDMONDS COMMUNITY COLLEGE</b>		Federal, state, and local requirements	92-06-070
Meetings	92-01-002		92-10-001
	92-05-040	Organization and operation	92-02-099
	92-07-081		92-07-002
	92-09-052		92-09-013
	92-12-001	Site certification	92-02-099
	92-13-072		92-06-070
	<b>92-15-054</b>		92-07-002
Parking and traffic	92-04-067		92-09-013
	92-09-055		92-10-001
<b>EDUCATION, STATE BOARD OF</b>		<b>ENERGY OFFICE</b>	
Appeal procedures	92-08-077	Energy efficiency services account	92-01-120
	<b>92-15-037</b>	<b>ENGINEERS AND LAND SURVEYORS</b>	
Certification		Evaluation of license candidates	92-01-101
general requirements	92-01-126	Examinations	92-01-100
	92-04-044		92-01-101
	92-13-021		92-04-008
	<b>92-15-038</b>		92-09-089
	<b>92-15-098</b>		92-12-053
vocational instructors	92-01-125		<b>92-15-139</b>
	92-05-039	Experience records	92-01-101
Internship certificate	92-08-077	Seals	
	<b>92-15-037</b>	usage	92-01-099
Meetings	92-01-022	<b>ENVIRONMENTAL HEARINGS OFFICE</b>	
Physical education requirement	92-05-067	Rules coordinator	92-03-008
	92-08-078	<b>EVERETT COMMUNITY COLLEGE</b>	
School bus drivers		Meetings	92-01-133
certificate issuance	92-13-098	<b>FAMILY INDEPENDENCE PROGRAM</b>	
standards and qualifications	92-13-098	(See <b>SOCIAL AND HEALTH SERVICES,</b>	
School construction		<b>DEPARTMENT OF)</b>	
funding assistance, priority system	92-13-047	<b>FISHERIES, DEPARTMENT OF</b>	
	92-13-059	<u>Commercial</u>	
School districts with restructuring plan		baitfish	
program hour requirements, waiver	92-01-124	seasons	92-08-022
	92-05-047	beam trawl, definition	92-13-040
	92-13-075	bottomfish	
teacher contact hours requirements,		coastal bottomfish	
waiver	92-01-124	catch limits	92-02-058
	92-05-047		92-03-030
	92-13-075		92-03-150
Schools for the twenty-first century			92-07-008
application contents	92-13-058		92-08-007
Special study activities			92-09-084
state reimbursement	92-01-123		92-11-021
	92-04-043		92-12-018
Teachers			92-02-058
certification requirements	92-01-126	gear	92-03-150
	92-01-127		92-07-008
	92-04-044	hold inspections	92-11-004
	92-06-027	nontreaty fish receiving tickets	92-11-004
	92-09-108	seasons	92-10-064
teacher preparation programs	92-01-126		
	92-01-127	Puget Sound bottomfish,	
	92-04-044	catch limits and gear	92-06-092
	92-06-027		92-08-079
	92-09-108		92-09-073
Vocational instructors			92-11-011
certification standards	92-01-125		
	92-05-039		



**Subject/Agency Index**  
(Citations in **bold type** refer to material in this issue)

**FISHERIES, DEPARTMENT OF—cont.**

commercial fisheries permits  
 emerging 92-09-129  
 experimental 92-09-129  
 trial 92-09-129  
 crabs, seasons and areas 92-01-034  
 92-02-039  
 salmon  
 Columbia River and tributaries 92-09-047  
 92-09-106  
 Columbia River  
 above Bonneville, seasons 92-04-051  
 92-07-007  
 below Bonneville, seasons 92-05-004  
 Puget Sound  
 net fisheries 92-09-137  
 92-11-083  
**92-15-105**  
 restrictions and closures 92-01-033  
 troll, seasons and gear 92-09-130  
**92-15-076**  
 Willapa Bay, seasons 92-10-081  
 sea urchins, seasons and areas 92-06-054  
 shad  
 Columbia River, seasons and gear 92-11-066  
 shrimp  
 areas 92-13-040  
 Hood Canal 92-10-020  
 92-11-065  
 Puget Sound fishery 92-10-002  
 92-11-008  
 sturgeon  
 Columbia River  
 above Bonneville, seasons 92-03-022  
 92-07-007  
 92-08-090  
 92-14-099  
 below Bonneville, seasons 92-05-004  
 maximum size 92-10-081  
 personal retention 92-10-081  
 Hydraulic project regulations 92-11-082  
 92-14-045  
**92-15-095**  
Personal use  
 abalone  
 bag limit 92-03-151  
 92-09-083  
 92-11-012  
 size limit 92-03-151  
 92-09-083  
 92-11-012  
 carp  
 gear 92-07-015  
 clams  
 areas and seasons  
 hardshell 92-03-151  
 92-09-083  
 92-11-012  
 razor 92-03-151  
 92-09-083  
 92-11-012  
 crabs, areas and seasons 92-01-035  
 92-03-151  
 92-09-083  
 92-11-012  
 crayfish, gear 92-03-151  
 92-11-012  
 food fish  
 species identification 92-03-151  
 92-11-012  
 halibut  
 areas and seasons 92-10-039  
 92-12-002  
**92-15-010**  
**92-15-040**  
 bag limits 92-10-039  
 92-12-002

**FISHERIES, DEPARTMENT OF—cont.**

lingcod, areas and seasons 92-03-151  
 92-09-083  
 92-11-012  
 oysters  
 areas and seasons 92-03-151  
 92-09-083  
 92-11-012  
 river mouth definitions 92-08-031  
 rockfish, areas and seasons 92-03-151  
 92-09-083  
 92-11-012  
 salmon  
 areas and seasons 92-03-151  
 92-11-012  
 92-12-013  
 92-13-071  
 92-14-046  
**92-15-086**  
**92-15-106**  
 bag limits 92-03-151  
 92-11-012  
 92-12-013  
 92-13-071  
 92-14-046  
**92-15-086**  
**92-15-106**  
 Canadian origin 92-09-083  
 Columbia River 92-04-050  
 92-08-059  
 92-09-047  
 92-09-083  
 Cowlitz River 92-09-083  
 gear 92-03-151  
 92-11-012  
 Hood Canal 92-04-011  
 Icicle River 92-11-020  
 Klickitat River 92-08-031  
 Little White Salmon River 92-08-031  
 Quillayute River 92-07-035  
 Skykomish River **92-15-052**  
 Soleduck River 92-07-035  
 Strait of Juan de Fuca 92-10-017  
 Wind River 92-08-031  
 shellfish  
 gear 92-09-083  
 shrimp  
 Hood Canal 92-11-065  
 sturgeon  
 areas and seasons 92-09-083  
 Columbia River below Bonneville  
 sanctuary 92-03-151  
 92-11-012

**FOREST PRACTICES BOARD**

Archaeological and historical sites 92-11-069  
 92-12-038  
**92-15-011**  
 Chemical handling, storage, and application 92-07-093  
 92-11-069  
**92-15-011**  
**92-15-113**  
 Cumulative effects 92-07-093  
 Environmental review  
 forest practices subject to review 92-06-004  
 92-11-069  
 92-12-038  
**92-15-011**  
 "Forest trees" defined 92-03-028  
 Meetings 92-01-117  
 92-04-005  
 92-07-013  
 92-09-065  
 92-10-080  
**92-15-031**  
 Pesticides application 92-11-069  
 92-12-038  
**92-15-011**

## Subject/Agency Index

(Citations in **bold type** refer to material in this issue)

### FOREST PRACTICES BOARD—cont.

Road construction and maintenance

Rules coordinator

State Environmental Policy Act  
forest practices subject to review

92-07-093  
92-11-069  
92-12-038  
**92-15-011**  
**92-15-113**  
92-01-118

Stream shade cover

92-06-004  
92-07-093  
92-11-069  
92-12-038  
**92-15-011**  
**92-15-113**  
92-07-093  
92-11-069  
**92-15-011**  
**92-15-113**

Timber harvest rate monitoring

92-02-055  
92-08-025  
92-07-093  
92-11-069  
**92-15-011**  
**92-15-113**

Timber harvest size and timing

92-01-119  
92-07-093  
92-09-064  
92-11-069  
**92-15-011**  
**92-15-113**

Watershed analysis system

Wetlands typing system

92-07-093  
92-11-069  
**92-15-011**  
**92-15-113**

Wildlife

critical wildlife habitats

92-11-069  
**92-15-011**  
92-11-069  
**92-15-011**

tree and log retention for habitat

### GAMBLING COMMISSION

Adjudicative proceedings  
discovery limitations

92-14-018  
92-14-019  
92-06-033  
92-14-018

forms

92-14-020  
92-14-018  
92-14-019  
92-14-020

hearings

Amusement games

annual activity reports

**92-15-055**  
**92-15-055**

fees

licenses

fees

suspension

92-15-055  
92-14-018  
92-14-019

operating requirements

recordkeeping requirements

**92-15-055**  
92-14-018  
92-14-057

wager and prize limitations

Meetings

Rules coordinator

92-08-057  
92-03-037  
92-03-036

### GENERAL ADMINISTRATION, DEPARTMENT OF

Banking, division of  
check cashiers and sellers  
regulation

92-02-105  
92-14-062  
92-14-109  
92-01-092  
92-04-027

investment in investment companies

mutual holding companies

establishment and operation

92-01-093  
92-06-041  
92-14-110

### GENERAL ADMINISTRATION, DEPARTMENT OF—cont.

Capitol grounds

parking fee payments

92-01-143  
92-04-037  
92-01-144  
92-09-076  
92-11-039  
92-01-142  
92-04-036

skateboarding prohibited on

traffic and parking regulations

Local government

self-insurance

92-09-155  
92-12-092

Office facilities, state-owned

parking fees

92-10-082

Rules coordinator

Self-insurance

92-05-037

local government entities

92-09-155  
92-12-092

Skateboarding on state capitol grounds

92-01-144  
92-09-076  
92-11-039

State-owned office facilities

parking fees

92-10-082

Surplus property

disposal priorities

92-05-042  
92-09-016

### GOVERNOR, OFFICE OF THE

Combined fund drive committee,  
state employee

92-09-096

public nonprofit charities, inclusion

92-10-036

Drug-free work place policy

92-01-109

Electronic message systems

92-13-006

Intergovernmental review process

92-08-060

Log export regulations

92-11-017

Support enforcement office

criminal justice agency,

limited designation

92-13-005

### GRAYS HARBOR COLLEGE

Adjudicative proceedings

92-01-056  
92-07-063

Board of trustees

92-09-041  
92-01-057

Financial aid

92-07-064  
92-08-043

Meetings

92-01-058  
92-07-065  
92-08-044

Organization and operation

92-01-047  
92-01-057  
92-07-064

Scholarships

92-08-043  
92-01-057  
92-07-064

Tuition and fees

92-08-043  
92-01-058  
92-08-044

### GREEN RIVER COMMUNITY COLLEGE

Meetings

92-02-033

Student code of conduct

92-14-048  
92-14-118

### GROWTH PLANNING HEARINGS BOARDS

Practice and procedure

92-12-023  
92-14-001

Public records, availability

**92-15-134**  
92-14-001

Rules coordinator

**92-15-134**  
92-12-022

State Environmental Protection Act

compliance

**92-15-133**  
92-14-001

92-15-134

**Subject/Agency Index**  
(Citations in **bold type** refer to material in this issue)

<b>HARDWOODS COMMISSION</b> (See <b>TRADE AND ECONOMIC DEVELOPMENT, DEPARTMENT OF</b> )			
<b>HEALTH, BOARD OF</b> (See <b>HEALTH, DEPARTMENT OF</b> )			
<b>HEALTH CARE AUTHORITY</b>			
Eligibility			
employees, retirees, and dependents	92-04-001		
	92-07-046		
	92-08-003		
Eligible entities	92-03-040		
Rules coordinator	92-06-001		
	92-07-061		
<b>HEALTH, DEPARTMENT OF</b>			
Abortion facilities			
criminal history, disclosure, and background inquiries		<b>92-15-085</b>	
Acupuncture advisory committee			
AIDS prevention and information certification	92-14-128		
application	92-14-128		
inactive status	92-14-128		
department investigation	92-14-128		
examinations	92-14-128		
fees	92-14-128		
Adult residential rehabilitation centers			
criminal history, disclosure, and background inquiries		<b>92-15-085</b>	
fees	92-10-014		
	<b>92-15-048</b>		
Alcoholism treatment facilities			
fee schedule	92-07-097		
	92-12-028		
Boarding homes			
criminal history, disclosure, and background inquiries		<b>92-15-085</b>	
fee schedule	92-07-097		
	92-12-086		
Cancer cases			
identifying and reporting, criteria and procedures	92-01-050		
information access standards	92-01-050		
Certificate of need			
open heart surgery services review	92-09-086		
	92-09-087		
	92-12-015		
Childbirth centers			
criminal history, disclosure, and background inquiries		<b>92-15-085</b>	
Chiropractic disciplinary board			
meetings	92-03-097		
peer review	92-01-070		
peer review committee			
fees	92-06-065		
	92-06-066		
	92-11-009		
meetings	92-04-049		
	92-05-058		
rules coordinator	92-01-048		
scope of practice	92-09-080		
	92-12-007		
	92-12-008		
Chiropractic examiners, board of			
chiropractic x-ray technicians			
preceptorship program	92-02-022		
reciprocity	92-02-022		
regulation	92-02-022		
temporary permits	92-02-022		
continuing education	92-12-090		
examinations	92-12-090		
fees	92-03-140		
	92-07-017		
meetings	92-01-008		
preceptor or supervisory doctor	92-12-090		
rules coordinator	92-01-048		
<b>HEALTH, DEPARTMENT OF—cont.</b>			
temporary permits			92-12-090
Community health clinics			
eligibility determination and funds distribution			92-07-077
			92-14-055
Criminal history, disclosure, and background inquiries		<b>92-15-085</b>	
Dental disciplinary board			
amalgam restoration practice standards		92-02-044	
		92-02-098	
		92-06-007	
infection control in dental offices		92-06-063	
		92-06-064	
		92-09-069	
mandatory reporting requirements		92-05-085	
rules coordinator		92-01-048	
rules update		92-05-012	
Dental examiners, board of			
examinations		92-01-122	
licensure		92-01-122	
rules coordinator		92-01-048	
Dental hygienists			
expanded functions education program			
application procedures		92-03-126	
requirements		92-03-006	
practical examination review			
procedures		92-11-014	
		<b>92-15-033</b>	
Dentists			
University of Washington residents			
licensing fees			92-13-009
			92-13-010
Drinking water certification			92-07-078
			<b>92-15-152</b>
fees			<b>92-15-149</b>
Drug manufacturing or storage sites, illegal, contractor certification for decontamination of			92-02-017
			92-03-143
			92-04-071
			92-10-027
Emergency medical services and trauma care systems			
administration		<b>92-15-034</b>	
certification		<b>92-15-034</b>	
continuing education		<b>92-15-034</b>	
definitions		<b>92-15-034</b>	
facilities		<b>92-15-034</b>	
licensure		<b>92-15-034</b>	
training		<b>92-15-034</b>	
trauma registry		<b>92-15-034</b>	
verification of trauma care services		<b>92-15-034</b>	
Health, board of			
drug manufacturing or storage sites, illegal, contractor certification for decontamination of			92-02-017
			92-03-143
			92-04-071
food service rules and regulations			92-03-142
			92-08-112
food worker permits			
fees			92-09-144
			92-14-093
local health officers			
drug manufacturing or storage sites			
contractor certification for decontamination			92-03-143
			92-04-071
			92-10-027
responsibilities			92-03-143
public water systems			
coliform monitoring and follow-up			92-04-070
rules coordinator			92-01-048
rules, housekeeping changes			92-02-019
			92-02-021
temporary worker housing standards			92-04-082
water recreation facilities			92-02-020
water safety teaching stations			92-02-020

**Subject/Agency Index**  
(Citations in **bold type** refer to material in this issue)

**HEALTH, DEPARTMENT OF—cont.**

Health care information	
acquisition, retention, and security	92-01-061 92-01-062 92-07-080
Hearing aid council	
licenses	
activities requiring	92-09-109
rules coordinator	92-01-048
Home care agencies	
criminal history, disclosure, and	
background inquiries	<b>92-15-085</b>
licensing fees	92-10-013 <b>92-15-084</b>
Home health agencies	
criminal history, disclosure, and	
background inquiries	<b>92-15-085</b>
licensing fees	92-10-013 <b>92-15-084</b>
Hospice agencies	
criminal history, disclosure, and	
background inquiries	<b>92-15-085</b>
licensing fees	92-10-013 <b>92-15-084</b>
Hospitals	
criminal history, disclosure, and	
background inquiries	<b>92-15-085</b>
fee schedules	92-07-097 92-12-028
Housing	
temporary worker housing standards	92-04-082
Mammography	
quality assurance standards	92-05-011
Massage board	
educational institutions	
approval	92-03-139 <b>92-15-153</b>
curriculum	92-03-139 <b>92-15-153</b>
national educational institutions	92-03-139 <b>92-15-153</b>
educational requirements	92-03-139 <b>92-15-153</b>
rules coordinator	92-01-048
Medical disciplinary board	
cooperation with investigation	92-07-058 92-07-096 92-10-069 92-01-048
rules coordinator	
Medical examiners, board of	
meetings	92-02-045
physicians assistants	
adjudicative proceedings	92-08-063 92-12-089
AIDS prevention and information education	92-08-063 92-12-089
certified physician assistants	92-08-063 92-12-089
continuing medical education	92-08-063 92-12-089
disciplinary actions	92-08-063 92-12-089
licensure	92-08-063 92-12-089
prescriptions	92-08-063 92-12-089
supervision or sponsorship	92-08-063 92-12-089
utilization	92-08-063 92-12-089
physicians and surgeons	
temporary permits	
fees	92-01-072 92-08-062 92-01-049 92-08-021
issuance and duration	

**HEALTH, DEPARTMENT OF—cont.**

recognized jurisdictions	92-01-049 92-08-021 92-01-048
rules coordinator	
surgical assistants	
duties	92-08-063 92-12-089
supervision	92-08-063 92-12-089
utilization	92-08-063 92-12-089
Naturopathic physicians	
medications, authority to use,	
prescribe, dispense, and order	92-02-097 92-06-020
Nursing, board of	
advanced registered nurse practitioners	
certification	92-14-126
definition	92-14-126
neonatal nurse practitioners	92-14-126
catheterization in the schools	92-01-023
rules coordinator	92-01-048
supervision of care and	
delegation of tasks	92-02-023
Nursing home administrators, board	
of examiners for	
rules coordinator	92-01-048
Nursing homes	
ethnic minority nursing home beds	
certificate of need review	92-01-110 92-05-057
Occupational therapy practice board	
examinations	92-09-153
licenses	
applicants licensed in other states	92-09-153
continuing competency	92-09-153
exemptions	92-09-153
expired license, reinstatement	92-09-153
inactive status	92-09-153
initial applicants	92-09-153
rules coordinator	92-01-048
substance abuse monitoring programs	92-09-153
temporary practice permits	92-09-153
Open heart surgery services, certificate of	
need review	92-09-086 92-09-087 92-12-015
Optometry board	
contact lens	
identification on prescriptions	92-14-092
"prescription" defined	92-03-032 92-14-092
records retention	92-03-032 92-14-092
specifications	92-14-092
continuing education	92-02-095 92-06-030
fees	92-01-071 92-06-029
prescriptions	
identification	92-03-032
rules coordinator	92-01-048
substance abuse monitoring	
programs	92-02-095 92-06-030
temporary practice permit	92-02-095 92-06-030
Osteopathic medicine and surgery,	
board of	
examination and licensure	92-02-095 92-13-065
licenses	
denials	92-13-065
fees	92-06-028 92-14-054
inactive and reactivation	92-13-065

**Subject/Agency Index**  
(Citations in **bold type** refer to material in this issue)

**HEALTH, DEPARTMENT OF—cont.**

permits	
temporary practice	92-13-065
rules coordinator	92-01-048
Pharmacy, board of	
anabolic steroids	92-04-029
continuing education requirements	92-03-029
controlled substances	
anabolic steroids	92-04-029
registration, recordkeeping, and storage requirements	92-04-029
schedule	92-04-029
facsimile prescription order transmission	92-03-095
	92-14-032
legend drugs	
identification	92-03-096
	92-09-001
	92-09-070
restrictions	92-03-096
	92-09-001
	92-09-070
samples	
distribution	92-04-041
	92-09-072
distribution reports	92-04-042
	92-09-071
licenses	
fees	92-03-124
	92-07-099
renewal	92-08-061
	92-03-124
	92-07-099
	92-08-061
	92-04-029
nonnarcotic stimulant drugs	
pharmaceutical wholesalers	
licenses	92-10-070
	<b>92-15-069</b>
record retention requirements	92-10-070
	<b>92-15-069</b>
regulation	92-10-070
	<b>92-15-069</b>
standards	92-10-070
	<b>92-15-069</b>
pharmacist's professional responsibilities	92-04-040
	92-08-058
practice and procedure	92-07-098
	92-10-026
	92-12-035
record retention requirements	92-07-098
	92-10-026
	92-12-035
rules coordinator	92-01-048
rules update	92-07-098
	92-10-026
	92-12-035
State Environmental Policy Act compliance	92-07-098
	92-12-035
Physical therapy, board of	
aide supervision ratio	92-08-039
examination appeal procedures	92-08-039
	92-08-111
examination scores	92-08-110
	92-08-111
meetings	92-01-078
professional conduct	92-08-039
records, requirements	92-08-039
rules coordinator	92-01-048
standards for appropriateness of care	92-08-039
temporary permits	92-08-111
unapproved schools, applicants from	92-08-039
Podiatric medical board	
fees	92-06-058
	92-14-053
rules coordinator	92-01-048

**HEALTH, DEPARTMENT OF—cont.**

Practical nursing board	
approved substance abuse monitoring program	92-02-046
curriculum standards in approved program	92-12-088
	92-02-046
	92-12-088
definitions	92-02-046
	92-12-088
discipline, standards of conduct	92-02-046
	92-12-088
documents indicating authorization to practice	92-02-046
examinations	92-12-088
executive secretary, qualifications	92-12-088
rules coordinator	92-01-048
Psychology, examining board of	
adjudicative proceedings	<b>92-15-151</b>
	<b>92-15-154</b>
	<b>92-15-148</b>
ethical conduct	
health care information	
acquisition and retention	92-03-107
	92-03-141
	92-07-016
	92-03-107
	92-03-141
	92-07-016
	92-03-144
	92-09-088
	92-14-091
	<b>92-15-150</b>
rules coordinator	92-01-048
Radiation protection, general provisions	92-06-008
	92-13-074
Radiologic technologists	
x-ray technicians, registration	92-05-010
Residential treatment facilities for psychiatrically impaired children and youth	
criminal history, disclosure, and background inquiries	<b>92-15-085</b>
fees	92-10-014
	<b>92-15-048</b>
Respiratory care practitioners	
educational programs	92-10-071
	<b>92-15-032</b>
fees	92-10-071
	<b>92-15-032</b>
temporary practice permits	92-10-071
	<b>92-15-032</b>
Rules coordinator	92-01-048
Rules, housekeeping changes	92-02-018
Rural health care facilities	
criminal history, disclosure, and background inquiries	<b>92-15-085</b>
Scoliosis screening	92-02-096
	92-06-067
Sex offender treatment providers	
continuing education requirements	92-07-079
	92-12-027
Veterinary board of governors	
animal technicians	
applications	92-02-057
examination eligibility	92-02-056
post high school courses	92-02-056
registration	
fees	92-03-125
	92-07-036
renewal	92-03-125
	92-07-036
supervision of	92-02-057
board investigations	92-02-056
	92-03-074
	92-14-127
examinations	92-03-074
	92-14-127
facilities	
recordkeeping requirements	92-14-127

**Subject/Agency Index**  
(Citations in **bold type** refer to material in this issue)

**HEALTH, DEPARTMENT OF—cont.**

licenses  
fees 92-03-125  
92-07-036  
renewal 92-03-125  
92-07-036  
retired active 92-03-074  
speciality 92-03-074  
92-14-127  
rules coordinator 92-01-048  
Water, drinking water certification 92-07-078  
Water recreation facilities 92-02-020  
Water safety teaching stations 92-02-020  
Water system evaluation and project review and approval fees 92-10-025  
X-ray technicians registration 92-05-010

**HIGHER EDUCATION COORDINATING BOARD**

American Indian endowed scholarship program 92-04-018  
Award for excellence in education academic grant program 92-13-077  
**92-15-136**  
Health professional loan repayment and scholarship program 92-03-002  
State need grant program cost of attendance 92-08-076  
92-09-141  
92-11-022  
92-11-023  
Washington state scholars program 92-13-076  
**92-15-135**

**HIGHER EDUCATION PERSONNEL BOARD**

Appeals  
certified records' transmission to superior court 92-09-125  
92-13-062  
92-14-114  
receipt procedure 92-09-124  
92-13-063  
rights of applicants 92-02-062  
92-05-028  
92-07-018  
92-09-126  
92-13-008  
Director's responsibilities 92-09-123  
92-13-055  
92-13-061  
92-14-113  
Eligible lists 92-01-028  
92-01-081  
92-02-025  
92-05-034  
Examination process 92-02-060  
92-02-063  
92-05-026  
92-05-029  
92-07-018  
92-09-120  
92-09-122  
92-13-008  
Layoff options 92-02-061  
92-05-027  
92-07-018  
92-09-121  
92-13-008  
Lead employee, definition 92-02-059  
92-02-064  
92-03-079  
92-05-072  
92-07-019  
Leave of absence without pay, excepted work period 92-02-066  
92-05-025  
Meetings 92-01-029

**HIGHER EDUCATION PERSONNEL BOARD—cont.**

Overtime 92-01-028  
92-01-081  
92-02-025  
92-05-034  
Position requirements 92-02-060  
92-07-018  
Reemployment, reasonable accommodation 92-01-031  
Rules coordinator 92-01-030  
92-06-069  
Schedule changes 92-01-028  
92-01-081  
92-02-025  
92-05-034  
Supervisor, definition 92-01-028  
92-01-081  
92-02-024  
92-02-065  
92-03-079  
92-05-073  
92-07-019  
Supervisor, premium pay 92-05-075  
92-07-019

**HIGHLINE COMMUNITY COLLEGE**

Administrative procedures 92-09-152  
**92-15-115**  
Admission and registration 92-09-152  
**92-15-115**  
Athletes, loss of eligibility for unlawful drug use, procedure 92-09-152  
**92-15-115**  
Board of trustees 92-09-152  
**92-15-115**  
Debts, services withheld for outstanding debts 92-09-152  
**92-15-115**  
Disciplinary hearings 92-09-152  
**92-15-115**  
Discrimination 92-09-152  
**92-15-115**  
Facilities use 92-09-152  
**92-15-115**  
Financial aid 92-09-152  
**92-15-115**  
Meetings **92-15-079**  
Organization 92-09-152  
**92-15-115**  
Parking and traffic rules 92-09-152  
**92-15-115**  
Policies and procedures 92-09-152  
**92-15-115**  
Public records, availability 92-09-152  
**92-15-115**  
Rules coordinator 92-09-152  
**92-15-115**  
Scholarships 92-09-152  
**92-15-115**  
Sexual harassment 92-09-152  
**92-15-115**  
State Environmental Policy Act compliance 92-09-152  
**92-15-115**  
Student records 92-09-152  
**92-15-115**  
Student rights and responsibilities 92-09-152  
**92-15-115**  
Tuition and fee schedule 92-09-152  
**92-15-115**

**HISPANIC AFFAIRS, COMMISSION ON**

Meetings 92-03-014  
92-08-046

**HORSE RACING COMMISSION**

Appeals 92-12-068  
92-13-089  
Jockey agents powers and duties **92-15-097**

## Subject/Agency Index

(Citations in **bold type** refer to material in this issue)

### HORSE RACING COMMISSION—cont.

Racing facility	
applicant, defined	92-12-066
license applications	92-13-087
management, disclosure	92-12-067
management, disclosure	92-13-088
management, disclosure	92-12-067
management, disclosure	92-13-088
Stewards	
decisions	92-12-066
decisions	92-13-087
punishment, authority to award	92-12-068
punishment, authority to award	92-13-089

### HUMAN RIGHTS COMMISSION

Meetings	92-01-075
	92-01-076
	92-02-077
	92-05-074
	92-06-031
	92-07-094
	92-09-082
	92-10-073
	92-12-077
	92-13-067
	<b>92-15-092</b>

### INDUSTRIAL INSURANCE APPEALS, BOARD OF

Rules coordinator	92-04-002
-------------------	-----------

### INFORMATION SERVICES, DEPARTMENT OF

Information services board meetings	92-02-004
Rules coordinator	92-01-039

### INSURANCE COMMISSIONER, OFFICE OF

Disability insurance	
minimum reserve standards	<b>92-15-103</b>
Hazardous condition of insurers	
authority of commissioner	<b>92-15-102</b>
standards for determining	<b>92-15-102</b>
Health care service contractors	
participating provider contracts	92-06-056
participating provider contracts	92-09-044
Health insurance	
solicitation of preproposal comment	92-14-129
Health maintenance organizations	
participating provider contracts	92-06-055
participating provider contracts	92-09-044A
Insurers	
financial reports	
annual audits	<b>92-15-104</b>
hazardous condition	
authority of commissioner	<b>92-15-102</b>
standards for determining	<b>92-15-102</b>
Longshore and harbor workers	
assigned risk plan	92-14-085
Mammograms	
coverage requirements and exceptions	92-13-013
coverage requirements and exceptions	92-13-014
coverage requirements and exceptions	92-13-086
Medicare supplement insurance	
benefit plans	92-14-130
standardized policy forms	92-01-045
standardized policy forms	92-06-021
standardized policy forms	92-01-032
Rules coordinator	
Salvage and subrogation recoveries	
annual statement	<b>92-15-101</b>

### INTEREST RATES

(See inside front cover)

### INVESTMENT BOARD

Meetings	92-01-090
	92-12-051

### JUDICIAL CONDUCT, COMMISSION ON

Meetings	92-03-020
	92-09-056
Rules coordinator	92-02-029

### LABOR AND INDUSTRIES, DEPARTMENT OF

Agricultural labor	
emancipated minors	92-10-078
emancipated minors	<b>92-15-099</b>
entry and inspection, department	
authority	92-10-078
authority	<b>92-15-099</b>
authority	92-08-098
authority	92-11-072
Agricultural safety standards	92-08-098
Agricultural safety standards	92-11-072
Boiler rules, board of	
definitions	92-08-087
definitions	92-11-070
definitions	92-01-006
definitions	92-14-029
new construction standards	92-08-087
new construction standards	92-11-070
nonnuclear repairs and alterations	92-08-087
nonnuclear repairs and alterations	92-11-070
rule interpretation and revision	92-08-087
rule interpretation and revision	92-11-070
Chiropractic services	
treatment limitation	92-07-100
treatment limitation	92-08-097
Commercial diving operations	
safety standards	<b>92-15-147</b>
Construction	
safety standards	92-03-137
safety standards	92-08-099
safety standards	92-09-148
safety standards	92-12-087
safety standards	<b>92-15-147</b>
Crime victim compensation	
allowed charges for hospital services	92-09-149
allowed charges for hospital services	92-11-071
Electrical inspections	
fees	92-03-136
fees	92-08-102
fees	92-08-103
fees	92-09-010
fees	92-09-011
Electricians	
contractor licensing fees	92-03-136
contractor licensing fees	92-08-102
contractor licensing fees	92-08-103
contractor licensing fees	92-09-010
contractor licensing fees	92-09-011
fees	92-03-136
fees	92-08-102
fees	92-08-103
fees	92-09-010
fees	92-09-011
Explosives	
safety standards	92-12-087
Hazardous chemicals	
safety standards	92-12-087
Indoor air quality standards	
solicitation of preproposal comment	92-03-135
Longshore, stevedore, and waterfront	
operations	<b>92-15-147</b>
Medical services	
nursing services and attendant care	92-05-041
Minors	
nonagricultural employment	92-12-093
nonagricultural employment	92-14-115
nonagricultural employment	<b>92-15-100</b>
nonagricultural employment	92-12-093
nonagricultural employment	92-14-115
nonagricultural employment	<b>92-15-100</b>
Nonagricultural employment of minors	92-12-093
Nonagricultural employment of minors	92-14-115
Nonagricultural employment of minors	<b>92-15-100</b>
Occupational health standards	
general	92-03-137
general	92-08-100
general	<b>92-15-147</b>
Prevailing wages	
terms and procedures used to determine	
for public works projects	92-01-104
for public works projects	92-08-101

**Subject/Agency Index**  
(Citations in **bold type** refer to material in this issue)

<b>LABOR AND INDUSTRIES, DEPARTMENT OF—cont.</b>		<b>LICENSING, DEPARTMENT OF—cont.</b>	
Rules coordinator	92-05-038	Auctioneers	
Safety and health standards		records requirements	92-09-097 92-13-045
commercial diving operations	<b>92-15-147</b>	suit or complaint notification	92-09-097 92-13-045
construction work	92-12-087 <b>92-15-147</b>	Business license services	
explosives	92-12-087	trade name searches, fees	92-07-095 92-10-010
general	92-12-087 <b>92-15-147</b>	Cosmetology, barbers, manicurists, and estheticians	92-04-006 92-10-079 <b>92-15-087</b>
hazardous chemicals	92-12-087	Disabled persons	
longshore, stevedore, and waterfront operations	<b>92-15-147</b>	parking privileges	92-03-076
Vocational rehabilitation providers		Financial Responsibility Act	
audits	92-14-116	administrative procedures	92-05-061 92-08-045
Workers' compensation		For hire vehicles	
labor/management cooperation program	92-03-053	permits and certificates, fees	92-09-145 92-12-036
reforestation industry	92-13-091	Franchises	
rules, classifications, rates, and rating system revisions	92-06-034	accredited investor, defined	92-02-054
<b>LAKE WASHINGTON TECHNICAL COLLEGE</b>		selling agent record requirements	92-02-054
Board of trustees	92-12-049 <b>92-15-081</b>	uniform franchise offering circular	92-02-054
Debts, services withheld for outstanding	92-12-049 <b>92-15-081</b>	Landscape architects	
Facilities use	92-12-049 <b>92-15-081</b>	examinations	92-05-013 92-10-030
Financial aid	92-12-049 <b>92-15-081</b>	Master license application	
Grievance procedures	92-12-049 <b>92-15-081</b>	trade name searches, fees	92-07-095 92-10-010
Library use	92-12-049 <b>92-15-081</b>	Motor vehicles	
Meetings	92-02-034	certificate of title	92-11-048 <b>92-15-024</b>
Organization and operation	92-12-049 <b>92-15-081</b>	destroyed vehicle rebuilt	92-11-047 <b>92-15-022</b>
Parking and traffic	92-12-049 <b>92-15-081</b>	destroyed vehicle reporting	92-11-047 <b>92-15-022</b>
Practice and procedure	92-12-049 <b>92-15-081</b>	disabled persons, parking privileges	92-03-076
Public records, availability	92-12-049 <b>92-15-081</b>	fleet vehicles	
Rules coordinator	92-12-049 <b>92-15-081</b>	license fee and excise tax abatement	92-11-048 <b>92-15-024</b>
Scholarships	92-12-049 <b>92-15-081</b>	registration	92-11-050 <b>92-15-025</b>
State Environmental Policy Act compliance	92-12-049 <b>92-15-081</b>	for hire vehicles	
Student conduct code	92-12-049 <b>92-15-081</b>	permits and certificates, fees	92-09-145 92-12-036
Tuition and fee schedule	92-12-049 <b>92-15-081</b>	gross weight license	92-02-100
<b>LAW REVISION COMMISSION</b>		license fees	
Meetings	92-11-064 <b>92-15-018</b> <b>92-15-078</b>	monthly abatement	92-02-100
Membership and duties	92-11-064 <b>92-15-018</b>	license renewals	92-11-050 <b>92-15-025</b>
Organization and operation	92-11-064 <b>92-15-018</b>	off-road and nonhighway vehicle use	
Public records, availability	92-11-064 <b>92-15-018</b>	permits	92-11-049 <b>92-15-021</b>
Research projects	92-11-064 <b>92-15-018</b>	registration	92-02-100 92-11-048 <b>92-15-021</b>
<b>LEGAL FOUNDATION OF WASHINGTON</b>		snowmobiles	
Meetings	92-08-008 92-11-031 <b>92-15-072</b>	registration	92-11-049 <b>92-15-021</b>
<b>LICENSING, DEPARTMENT OF</b>		temporary permits, departmental transit permits	92-03-077 92-11-050 <b>92-15-025</b>
Administrative procedures	92-05-061 92-08-045	travel trailers and campers	
Aircraft fuel tax rules		title purpose only documents	
mitigation of penalties and interest	92-01-015	issuance	92-11-048 <b>92-15-024</b>
Architects, board of registration for meetings	92-01-019 92-05-062	veterans	
		free license	92-02-100
		Motorcycle safety advisory board meetings	92-01-011
		Public records	
		disclosure	92-05-088 92-09-107
		Real estate appraisers	
		certification application	92-14-084



**Subject/Agency Index**  
(Citations in **bold type** refer to material in this issue)

<b>LICENSING, DEPARTMENT OF—cont.</b>		<b>LOTTERY COMMISSION—cont.</b>	
definitions	92-14-084	price	92-03-146
examinations	92-14-084		92-05-069
experience requirements	92-14-084		92-08-002
fees	92-14-084	prizes	92-03-146
temporary practice	92-14-084		92-05-069
Real estate commission			92-08-002
meetings	92-03-016	purchases	92-03-146
	92-03-033		92-05-069
Rules coordinator	92-03-001		92-08-002
Securities division		suspension or termination	92-03-146
appraisals	92-14-089		92-05-069
escrow accounts	92-14-089		92-08-002
offering circulars	92-14-089	Daily Game	
real estate mortgages when		drawings	92-08-093
offered or sold as a unit	92-14-090		92-11-033
recordkeeping requirements	92-14-089		92-12-091
registration requirements	92-14-089		<b>92-15-082</b>
Special fuel tax rules		<u>Instant game number 69 – Gold Rush</u>	
mitigation of penalties and interest	92-01-016	criteria	92-03-048
user license	92-01-014	<u>Instant game number 71 – Lucky 7's II</u>	
Title and registration advisory committee		criteria	92-03-048
meetings	92-13-046	definitions	92-03-048
	92-14-049	ticket validation	92-03-048
Vessel registration		<u>Instant game number 73 – Whirlwin</u>	
confidential vessel registration	92-11-046	criteria	92-03-048
	<b>92-15-023</b>	definitions	92-03-048
exemptions	92-03-075	ticket validation	92-03-048
ownership transfer	92-03-075	<u>Instant game number 74 – Grand Slam II</u>	
temporary permit to operate	92-06-009	criteria	92-03-048
title or registration application	92-03-075	definitions	92-03-048
title transfer	92-06-009	ticket validation	92-03-048
<b>LIQUOR CONTROL BOARD</b>		<u>Instant game number 75 – Movie Mania</u>	
Alcohol raffle permit	92-01-079	criteria	92-03-146
Bad order claims, procedures	92-09-143		92-05-069
	92-14-028	definitions	92-03-146
Banquet permit functions			92-05-069
liquor sources, purchase, and delivery	92-01-080	ticket validation	92-03-146
Beer			92-05-069
bad order claims, procedures	92-09-143	<u>Instant game number 75 – Wildcard</u>	
	92-14-028	criteria	92-08-002
label approval	92-03-109	definitions	92-08-002
Conduct on licensed premises, regulation	92-01-105	ticket validation	92-08-002
Licenses		<u>Instant game number 76 – Gold &amp; Glory</u>	
applicant certification	92-08-085	criteria	92-03-146
	92-14-024		92-08-002
class A and/or D criteria	92-08-089	definitions	92-03-146
	92-14-026		92-08-002
class H criteria	92-08-086	ticket validation	92-03-146
	92-08-088		92-08-002
	92-14-022	<u>Instant game number 77 – Wildcard</u>	
	92-14-025	criteria	92-03-146
Licensed premises		definitions	92-03-146
managers	92-08-084	ticket validation	92-03-146
	92-14-023	<u>Instant game number 77 – Three Cards Up</u>	
Meetings	92-09-142	criteria	92-08-093
	92-14-027		92-11-033
Operations and procedure	92-09-142	definitions	92-08-093
	92-14-027		92-11-033
Rules coordinator	92-03-017	ticket validation	92-08-093
Wholesalers			92-11-033
stock movement	92-02-014	<u>Instant game number 78 – Applebucks</u>	
Wine		criteria	92-08-093
label approval	92-03-110		92-11-033
		definitions	92-08-093
			92-11-033
<b>LOTTERY COMMISSION</b>		ticket validations	92-08-093
Beat the State			92-11-033
definitions	92-03-146	<u>Instant game number 79 – Movie Money</u>	
	92-05-069	criteria	92-08-093
	92-08-002		92-11-033
drawings	92-03-146	definitions	92-08-093
	92-05-069		92-11-033
	92-08-002	ticket validation	92-08-093
	92-12-091		92-11-033
	<b>92-15-083</b>		92-08-093
play	92-03-146		92-11-033
	92-05-069		
	92-08-002		

**Subject/Agency Index**  
(Citations in **bold type** refer to material in this issue)

**LOTTERY COMMISSION—cont.**

<u>Instant game number 80 – Bowling for Bucks</u>	
criteria	92-08-093
	92-11-033
definitions	92-08-093
	92-11-033
ticket validation	92-08-093
	92-11-033
<u>Instant game number 81 – Joker Poker</u>	
criteria	92-12-091
	<b>92-15-082</b>
definitions	92-12-091
	<b>92-15-082</b>
ticket validation	92-12-091
	<b>92-15-082</b>
<u>Instant game number 82 – 10th Anniversary Game</u>	
criteria	92-12-091
	<b>92-15-082</b>
definitions	92-12-091
	<b>92-15-082</b>
ticket validation	92-12-091
	<b>92-15-082</b>
<u>Instant game number 83 – Surprise Package</u>	
criteria	92-12-091
	<b>92-15-082</b>
definitions	92-12-091
	<b>92-15-082</b>
ticket validation	92-12-091
	<b>92-15-082</b>
<u>Instant game number 84 – Fat Cat</u>	
criteria	92-12-091
	<b>92-15-082</b>
definitions	92-12-091
	<b>92-15-082</b>
ticket validation	92-12-091
	<b>92-15-082</b>
<u>Instant game number 85 – 7-11-21</u>	
criteria	92-12-091
	<b>92-15-082</b>
definitions	92-12-091
	<b>92-15-082</b>
ticket validation	92-12-091
	<b>92-15-082</b>
Lotto	
definitions	92-08-093
	92-11-033
play prize	92-08-093
	92-11-033
prizes	92-03-146
	92-07-014
	92-08-093
	92-11-033
On-line games	
criteria	92-08-093
	92-11-033
definitions	92-08-093
	92-11-033
drawings	92-08-093
	92-11-010
	92-11-033
<u>Paper scratch game number 501 – Jackpot</u>	
criteria	92-03-048
definitions	92-03-048
ticket validation	92-03-048
<u>Paper scratch game number 502 – Lucky Charm</u>	
criteria	92-03-048
definitions	92-03-048
ticket validation	92-03-048
<u>Paper scratch game number 503 – Jacks-R-Better</u>	
criteria	92-03-048
definitions	92-03-048
ticket validation	92-03-048

**LOTTERY COMMISSION—cont.**

<u>Paper scratch game number 504 – Treasure Hunt</u>	
criteria	92-03-146
	92-08-094
definitions	92-03-146
	92-08-094
ticket validation	92-03-146
	92-08-094
<u>Paper scratch game number 505 – Rooster Tail</u>	
criteria	92-03-146
	92-08-094
definitions	92-03-146
	92-08-094
ticket validation	92-03-146
	92-08-094
<u>Paper scratch game number 506 – Criss Cross</u>	
criteria	92-03-146
	92-08-094
definitions	92-03-146
	92-08-094
ticket validation	92-03-146
	92-08-094
Paper scratch games	
authorization	92-03-048
criteria	92-03-048
definitions	92-03-048
retailer settlement	92-03-048
ticket validation	92-03-048
Quinto	
definitions	92-08-093
	92-11-033
drawings	92-12-091
	<b>92-15-083</b>
	92-08-093
	92-11-033
play price	92-11-033
<b>LOWER COLUMBIA COLLEGE</b>	
Adjudicative proceedings	92-04-058
	92-09-005
Admission, registration and graduation	92-04-062
	92-09-008
Athletes, loss of eligibility for unlawful drug use	92-04-060
	92-09-006
Discrimination, grievance procedure	92-04-064
	92-09-092
Facilities use	92-04-063
	92-09-009
Grievance procedure for discriminatory conduct	92-04-064
	92-09-092
Records index	92-04-057
	92-09-004
Sexual harassment, grievance procedure	92-04-064
	92-09-092
Student records access	92-04-065
	92-09-093
Student rights and responsibilities	92-04-059
	92-09-094
Tenure	92-04-061
	92-09-007
<b>MARINE SAFETY, OFFICE OF</b>	
Marine overnight board	
meetings	92-12-069
Regional marine safety committees	
meetings	92-12-070
	92-12-071
	92-12-072
	92-12-073
	92-13-068
	92-13-069
Rules coordinator	92-05-014
<b>MARITIME COMMISSION</b>	
Assessments	
rates and terms	92-03-061
	<b>92-15-050</b>

**Subject/Agency Index**  
(Citations in **bold type** refer to material in this issue)

<b>MARITIME COMMISSION—cont.</b>		<b>OUTDOOR RECREATION, INTERAGENCY COMMITTEE FOR</b>	
Meetings	92-02-027	Meetings	92-01-005
Rules coordinator	92-08-073		92-04-052
	92-05-003		92-04-053
			92-05-030
			92-12-078
<b>MINORITY AND WOMEN'S BUSINESS ENTERPRISES, OFFICE OF</b>		<b>PARKS AND RECREATION COMMISSION</b>	
Adjudicative proceedings	92-11-018	Environmental learning centers	92-07-083
	92-11-019		92-10-018
	<b>92-15-077</b>	Field operations	
Administrative procedures	92-07-001	staff dress standards	92-01-106
	92-07-102		92-04-072
	92-07-103	Fort Worden	
	92-11-007	reservation system	92-01-038
Bid specifications	92-09-151		92-05-002
Contract substitutions	92-09-151	Land exchange	
Goals and goal setting	92-09-151	fee	92-09-158
	92-14-121		92-11-025
Joint ventures	92-09-151		92-12-082
Reporting requirements	92-09-151		<b>92-15-121</b>
Meetings	92-02-084		92-01-036
<b>NATURAL RESOURCES, DEPARTMENT OF</b>		Meetings	
Adjudicative proceedings	92-01-027	Metal detectors	
	<b>92-15-137</b>	use in state parks	92-12-080
Burning permit program			<b>92-15-118</b>
requirements and exceptions	92-11-075	Public records	
	92-14-096	copying fees	92-07-062
Fees			92-10-019
public records, copying	92-12-074	Rules coordinator	92-01-037
Forest closures		Sno-park permit	
closed season	92-09-061	decal display	92-09-160
	92-14-131		92-11-081
Forest practices board			92-12-012
see FOREST PRACTICES BOARD		fees	<b>92-15-119</b>
Geothermal resources development	92-06-003		92-09-159
Land boundary surveys and geodetic			92-12-052
control surveys, standards	92-03-007		92-12-081
Land descriptions, guidelines	92-03-007		<b>92-15-120</b>
Leasing of state-owned lands		<b>PERSONNEL APPEALS BOARD</b>	
geothermal resources development	92-06-003	Briefing schedules	92-05-049
performance security	92-06-003	Motions	
procedure	92-12-075	filing deadlines	92-05-049
Milwaukee road corridor, recreational		Rules coordinator	92-03-027
use	92-05-036	Service requirements	92-05-049
Natural heritage advisory council			
meetings	92-10-072	<b>PERSONNEL BOARD</b>	
Natural resources, board of		Career executive program	
meetings	92-03-054	employee selection	92-10-065
	92-13-004		92-14-067
	<b>92-15-019</b>	position nomination procedures	92-03-100
Outdoor burning		removal from program	92-10-065
suspension	92-13-057		92-14-067
Public records		Certification	
copying fees	92-12-074	errors and correction	92-02-009
Rules coordinator	92-01-026	Classified and exempt service,	
Surface mining		movement between	92-06-089
reclamation obligations			92-10-011
performance securities	<b>92-15-138</b>	College recruitment program	92-12-030
"segment" defined	92-10-068		92-14-068
		Disciplinary actions	92-10-066
<b>OLYMPIC AIR POLLUTION CONTROL AUTHORITY</b>			92-08-096
Solid fuel burning devices		Dismissal	92-12-032
requirements if failure to		unauthorized leave, procedures	92-04-034
meet attainment	92-03-012		92-08-009
Violations		Elevation, qualification	92-14-065
civil penalties	92-05-048	Exempt and classified service,	
	92-09-079	movement between	92-06-089
notice and hearing	92-05-048		92-10-011
	92-09-079	Family care requirements	92-12-030
Woodstoves			92-14-068
requirements if failure to		Leave	92-03-098
meet attainment	92-03-012	family care needs	92-03-101
			92-03-098
			92-03-101

## Subject/Agency Index

(Citations in **bold type** refer to material in this issue)

<b>PERSONNEL BOARD—cont.</b>		<b>PUBLIC DISCLOSURE COMMISSION—cont.</b>	
without pay, effects	92-08-091	Campaigns	
	92-12-033	contributions and expenditures form	92-12-084
"Manager" defined	92-03-099	filing	92-12-084
Nurses		registration statements	92-12-084
shift premium provisions	92-08-092	reporting, abbreviated	92-05-079
	92-12-031		92-12-084
	92-14-064	Compensation	
Paid sick leave	92-03-098	sales commissions, reporting	92-05-078
Part-time employees, promotional rights	92-02-010		92-05-082
Promotional rights, part-time employees	92-02-010		92-08-105
Reinstatement following appeal	92-04-034	Contributions	
	92-08-009	contribution and expenditure form	92-01-131
Shift premium provisions and compensation	92-06-090		92-05-080
	92-08-092		92-12-084
	92-10-012	limitations	92-05-079
	92-12-029	"receipt" defined	92-05-081
	92-12-031	Disclosure petition form	92-01-131
	92-14-063		92-05-080
	92-14-064	Organization	92-03-005
Sick leave, paid		Redistricting	
family care requirements	92-03-098	"reelect," "retain," or "return"	
Unauthorized leave		used in political advertising	92-08-104
presumption of abandonment, procedures	92-04-034		92-12-037
	92-08-009	Reporting requirements	
		hearing to modify	92-01-131
<b>PERSONNEL, DEPARTMENT OF</b>			92-05-080
Rules coordinator	92-01-087	suspension of	92-01-131
<b>PIERCE COLLEGE</b>			92-05-080
Meetings	92-01-003	Sales commissions	
	<b>92-15-075</b>	reporting requirements	92-05-078
Personnel rules	92-01-085		92-05-082
	92-03-031		92-08-105
Rules coordinator	92-01-004		
<b>PILOTAGE COMMISSIONERS, BOARD OF</b>		<b>PUBLIC INSTRUCTION, SUPERINTENDENT OF</b>	
Licenses		Allocations, 1991-93	
pilots	92-08-049	early intervention services	92-02-026
	92-08-053	special	92-03-023
	92-14-070	Budget extension, filing deadline	92-03-024
reinstatement	92-08-050	Early intervention services	
renewal	92-03-108	allocations	92-02-026
	92-04-073	Elementary and secondary school amendments	
	92-08-050	of 1988 compliance	92-11-028
retired pilots	92-03-108	Excellence in education awards	92-03-063
New pilots		Financial assistance to local	
licensing	92-08-049	school districts	
	92-08-053	compliance with federal regulations	92-10-062
	92-14-070		92-11-028
	92-04-075	Institutional education program	92-03-045
	92-08-051		<b>92-15-094</b>
	92-08-054	Learning assistance programs	
qualifications	92-07-075	waiver of regulations	92-06-053
	92-12-079		<b>92-15-071</b>
	<b>92-15-064</b>	Local school districts	
Pilotage tariff rates		financial assistance, state compliance	
Grays Harbor pilotage district	92-08-048	with federal regulations	92-10-062
	92-11-035	Low-income student eligibility	
	92-14-069	documentation	<b>92-15-122</b>
Puget Sound pilotage district	92-07-076	Maintenance and operation levies	<b>92-15-002</b>
	92-14-007	Public records, availability	92-06-052
	92-14-008		92-10-016
Vessel certification form	92-04-074	Special education	
	92-08-052	waiver of regulations	92-06-053
			<b>92-15-071</b>
<b>POLLUTION LIABILITY INSURANCE AGENCY</b>		Teacher assistance program	92-01-082
Eligibility assessment reimbursement	92-06-060		92-05-068
	92-09-091	Traffic safety education program	
Rules coordinator	92-04-033	allocation procedures	<b>92-15-093</b>
<b>PROFESSIONAL ATHLETIC COMMISSION</b>		low-income student tuition	
Rules coordinator	92-14-021	assistance	92-03-138
<b>PUBLIC DISCLOSURE COMMISSION</b>		minimum hour requirements	92-03-138
Advertising		program requirements	<b>92-15-123</b>
"reelect," "retain," or "return"		Transportation	
used in political advertising	92-08-104	allocations for operations	92-04-009
	92-12-037		92-08-024
Auctions			<b>92-15-146</b>
items donated and sold, report form	<b>92-15-116</b>		

**Subject/Agency Index**  
(Citations in **bold type** refer to material in this issue)

<b>PUBLIC WORKS BOARD</b>		<b>REVENUE, DEPARTMENT OF—cont.</b>	
(See <b>COMMUNITY DEVELOPMENT, DEPARTMENT OF</b> )		Life insurance agents, brokers, and solicitors	
<b>PUGET SOUND AIR POLLUTION CONTROL AGENCY</b>		"employee" defined	92-03-066
Acceptable source impact levels	92-03-092		92-03-067
Aerators and sterilizers		taxability of amounts received by	92-06-082
ethylene oxide emission control	92-03-091		<b>92-02-002</b>
Chromic acid plating and anodizing	92-03-091	Lodging, persons selling	<b>92-15-147A</b>
Compliance dates	92-03-102	services and other business	
Definitions	92-03-092	activities, taxation on	92-01-041
	92-03-102		92-05-064
Fees	92-01-089	Oil spill response and administration	
Gasoline		tax	
loading terminals	92-03-073	offloading crude oil or petroleum	
stations	92-03-073	product from vessel	92-04-015
Outdoor fires			92-07-092
exemptions from prohibitions	92-04-056		92-10-006
	92-09-098	solicitation of preproposal comment	92-05-052
	92-14-119	Penalties and interest	92-03-025
prohibited areas	92-04-056	Persons engaging in business, definition	92-02-001
	92-09-098		92-03-066
	92-14-119		92-06-082
prohibited types	92-04-056	Property tax	
	92-09-098	deferral of assessments and/or tax	92-04-068
Perchloroethylene dry cleaner	92-03-092		92-04-078
Registration program, fee schedule	92-01-089		92-06-038
Sterilizers and aerators		disabled persons, exemption	<b>92-15-057</b>
ethylene oxide emission control	92-03-091		92-04-069
			92-04-079
<b>PUGET SOUND WATER QUALITY AUTHORITY</b>			92-06-039
Meetings	92-07-004	refunds	<b>92-15-058</b>
	92-09-015	rate of interest	92-14-086
	<b>92-15-017</b>	senior citizens, exemption	92-04-069
Water quality management plan programs	92-01-141		92-04-079
			92-06-039
<b>RENTON TECHNICAL COLLEGE</b>			<b>92-15-058</b>
Meetings	92-13-003	Public utility tax	
Rules coordinator	92-13-003	energy conservation and cogeneration	
		deductions	<b>92-15-044</b>
<b>RETIREMENT SYSTEMS, DEPARTMENT OF</b>		Refunds for overpayment of taxes	92-05-017
Early retirement	92-11-027	Rules coordinator	92-01-055
Fees		Sales tax	
untimely or inaccurate reports	92-11-027	legend drugs, exemption	92-01-042
by employees	92-12-048		92-05-065
	92-01-077	prosthetic and orthotic devices,	
Rules coordinator	92-11-026	ostomic items, and medically	
		prescribed oxygen, exemption	92-01-042
			92-05-065
<b>REVENUE, DEPARTMENT OF</b>		Special assessments	
Accounting		deferral	92-04-068
accrual method, tax reporting			92-04-078
duties	92-03-026		92-06-038
cash receipts reporting	92-03-026	Statute of limitations on assessments	<b>92-15-045</b>
Agricultural land valuation	92-03-068	Timber excise tax	
Business and occupation tax		stumpage sales reporting	92-10-060
life insurance agents, brokers,	92-02-002		92-14-111
and solicitors, definition	92-03-067		92-14-112
	92-02-003	stumpage values	92-02-067
Cigarette vendor licenses	92-03-065		92-06-037
	92-06-081		92-06-040
Computer software			92-06-057
definitions	92-01-132		92-08-018
valuation and taxation	92-01-132		92-10-061
Cosmetologists, barbers, and manicurists			92-14-083
"engaging in business" defined	92-03-066	Use tax	
	92-06-082	automobile dealers	
Employees distinguished from persons		demonstrator and executive vehicles	92-01-044
engaging in business	92-02-001		92-05-066
	92-03-066	legend drugs, exemption	92-01-042
	92-06-082		92-05-065
Hotels and motels		prosthetic and orthotic devices,	
telephone service, taxation on	92-01-041	ostomic items, and medically	
	92-05-064	prescribed oxygen, exemption	92-01-042
Interest and penalties	92-03-025		92-05-065

## Subject/Agency Index

(Citations in **bold type** refer to material in this issue)

### RULES COORDINATORS

Asian American affairs, commission on 92-15-124  
Bates Technical College 92-07-101  
Blind, Washington state school for the 92-01-021  
Building code council 92-12-010  
Central Washington University 92-01-107  
Chiropractic disciplinary board 92-01-048  
Chiropractic examining board 92-01-048  
Clover Park Technical College 92-04-038  
Code reviser's office 92-12-050  
County road administration board 92-01-001  
Deaf, Washington state school for the 92-02-047  
Dental disciplinary board 92-04-017  
Dental examining board 92-01-020  
Eastern Washington University 92-01-048  
Ecology, department of 92-01-048  
Environmental hearings office 92-06-001  
Forest practices board 92-07-061  
Gambling commission 92-01-048  
General administration, department of 92-01-048  
Growth planning hearings boards 92-06-069  
Health, board of 92-09-152  
Health care authority 92-04-002  
Health, department of 92-01-039  
Hearing aids council 92-01-032  
Higher education personnel board 92-02-029  
Highline Community College 92-05-038  
Industrial insurance appeals, board of 92-12-049  
Information services, department of 92-03-001  
Insurance commissioner, office of 92-03-017  
Judicial conduct, commission on 92-05-014  
Labor and industries, department of 92-05-003  
Lake Washington Technical College 92-01-048  
Licensing, department of 92-01-048  
Liquor control board 92-01-048  
Marine safety, office of 92-01-048  
Maritime commission 92-01-048  
Massage board 92-01-048  
Medical disciplinary board 92-01-048  
Medical examiners, board of 92-01-048  
Natural resources, department of 92-01-026  
Nursing, board of 92-01-048  
Nursing home administrators, board of examiners for 92-01-048  
Occupational therapy practice, board of 92-01-048  
Optometry board 92-01-048  
Osteopathic medicine and surgery board 92-01-048  
Parks and recreation commission 92-01-037  
Personnel appeals board 92-03-027  
Personnel, department of 92-01-087  
Pharmacy, board of 92-01-048  
Physical therapy, board of 92-01-048  
Pierce college 92-01-004  
Podiatric medical board 92-01-048  
Pollution liability insurance agency 92-04-033  
Practical nursing, board of 92-01-048  
Professional athletic commission 92-14-021  
Psychology, examining board of 92-01-048  
Renton Technical College 92-13-003  
Retirement systems, department of 92-01-077  
Revenue, department of 92-11-026  
Shoreline Community College 92-01-055  
Skagit Valley College 92-02-043  
Social and health services, department of 92-03-060  
South Puget Sound Community College 92-03-072

### RULES COORDINATORS—cont.

Tax appeals, board of 92-01-060  
Trade and economic development, department of 92-03-071  
Traffic safety commission 92-04-066  
Transportation commission 92-03-003  
Transportation improvement board 92-05-059  
Transportation, department of 92-03-004  
University of Washington 92-02-036  
Utilities and transportation commission 92-01-113  
Veterinary board of governors 92-01-048  
Washington state library 92-14-034  
Washington state patrol 92-01-010  
Washington State University 92-06-016  
Whatcom Community College 92-03-011  
Wildlife, department of 92-12-021

### SEATTLE COMMUNITY COLLEGES

Meetings 92-02-032  
92-04-012  
92-06-025  
92-08-019  
92-09-003  
92-14-006  
92-15-005

### SECRETARY OF STATE

Absentee ballot procedures 92-05-023  
telephone requests 92-15-140  
Archives and records management, division of 92-12-076  
archives/public records access 92-09-018  
local records, disposition authorization 92-09-017  
local records committee, membership and duties 92-02-068  
public records, disposal methods 92-05-060  
recycling, disposal of records by 92-02-068  
security microfilm storage 92-05-060  
92-04-026  
92-08-020  
Elections 92-05-023  
absentee ballot procedures 92-15-140  
telephone requests 92-15-141  
electronic facsimile documents 92-05-023  
filing procedures 92-08-032  
presidential preference primary 92-09-112  
procedures 92-10-038  
92-12-083  
International student exchange agencies 92-02-103  
registration 92-02-104  
92-10-023  
92-15-070  
Local records committee 92-09-017  
membership and duties 92-09-018  
records, disposition authorization 92-05-023  
Presidential preference primary 92-08-032  
absentee ballot procedures 92-04-077  
Productivity board 92-09-048  
teamwork incentive program 92-04-026  
Security microfilm storage 92-08-020  
SHORELINE COMMUNITY COLLEGE  
Hepatitis B immunization for health occupations students 92-04-055  
92-08-040  
Immunization for health occupations students 92-04-055  
92-08-040  
Meetings 92-03-057  
Rules coordinator 92-02-043

**Subject/Agency Index**  
(Citations in **bold type** refer to material in this issue)

<b>SKAGIT VALLEY COLLEGE</b>		<b>SOCIAL AND HEALTH SERVICES,</b>	
Meetings	92-01-102	<b>DEPARTMENT OF—cont.</b>	
	92-05-032	enforcement	92-08-001
Rules coordinator	92-03-060		92-13-025
<b>SOCIAL AND HEALTH SERVICES,</b>		obligations	92-13-026
<b>DEPARTMENT OF</b>			92-02-049
Adult family homes			92-02-050
licensing requirements	92-04-035		92-04-021
	92-06-011		92-08-001
	92-08-056		92-08-034
	92-12-009		92-13-025
	<b>92-15-043</b>	responsibilities of office of	92-13-026
	<b>92-15-144</b>	support enforcement	92-08-001
Aid to families with dependent children			92-13-025
child day care services	92-08-029		92-13-026
	92-08-030		
	92-11-062	Civil commitment cost reimbursement	
Consolidated emergency assistance program		sexually violent predator	
eligibility	92-08-005	law enforcement costs	<b>92-15-008</b>
	92-08-006	Community options program entry system (COPES)	
	92-10-034	program restrictions	<b>92-15-130</b>
	92-11-056		<b>92-15-142</b>
	92-14-031	Developmentally disabled	
	<b>92-15-074</b>	eligibility for services	92-04-004
emergent situations		family support services	92-05-076
requirements	92-05-035		92-05-077
	92-09-033		92-09-113
fair hearing process	92-11-002		92-09-114
	92-14-050		92-09-119
	<b>92-15-059</b>	funds distribution to counties	92-13-024
income and resources disregard	92-05-005		92-09-045
	92-05-008		92-09-046
	92-09-029		92-09-051
income assistance child care program	92-01-136		92-13-032
income budgeting practices	<b>92-15-131</b>	plan development and submission	92-06-059
	<b>92-15-132</b>		92-09-115
<b>JOBS</b> program participation	92-10-034	service need levels	92-05-076
	92-14-031		92-05-077
mandatory monthly reporting requirements	<b>92-15-143</b>		92-09-114
	<b>92-15-145</b>	Drug or alcohol addiction	
medical programs eligibility	92-05-006	program eligibility	92-03-047
	92-05-007	referral criteria	92-03-047
	92-09-030	Family independence program	
quarter of work, definition	92-02-072	employability reassessment	92-04-003
	92-02-074	medical programs eligibility	92-05-006
	92-04-024		92-05-007
	92-08-041		92-09-030
registration with public employment		meetings	92-01-138
agency	92-10-034	Food stamp program	
	92-14-031	alien eligibility	92-10-028
Alcohol or drug addiction			92-10-029
program eligibility	92-03-047		92-14-030
referral criteria	92-03-047	benefits, restoration of lost	92-01-139
Child care			92-04-020
day care			92-08-035
general and seasonal services	92-08-029	coupons	
	92-08-030	issuance	92-12-041
	92-11-062		<b>92-15-039</b>
licensing requirements	92-04-035	food coupon authorization	
	92-06-011	use during validity period	92-12-041
	92-08-056		<b>92-15-039</b>
	92-12-009	general assistance clients,	
	<b>92-15-043</b>	categorical eligibility	92-07-047
disqualification from authority to			92-09-116
care for children	92-02-101	homeless shelter deduction	92-05-043
	92-04-022		92-05-044
	92-08-038		92-05-045
providers			92-05-046
criminal history inquiry	92-03-148		92-09-031
Child support			92-09-032
assignment of support rights	92-08-001	income budgeting	
	92-13-025	prospective	92-13-051
	92-13-026	retrospective	92-13-052
	92-08-001	income exclusions	92-03-119
eligibility for services	92-13-025		92-08-108
	92-13-026		92-08-109
			92-11-063

## Subject/Agency Index

(Citations in **bold type** refer to material in this issue)

### SOCIAL AND HEALTH SERVICES, DEPARTMENT OF—cont.

income reporting 92-13-053  
 intentional program violations 92-09-028  
 92-12-044  
 monthly reporting 92-09-066  
 92-12-042  
 overissuances 92-09-037  
 92-12-043  
 prospective income budgeting 92-13-051  
 resources exemptions 92-06-042  
 92-06-045  
 92-09-117  
 retrospective income budgeting 92-13-052  
 "student" defined 92-08-010  
 92-08-014  
 92-11-059  
 student eligibility 92-08-012  
 92-08-015  
 92-08-108  
 92-08-109  
 92-11-058  
 92-11-063

General assistance  
 alcoholism or drug addiction  
 program eligibility 92-03-047  
 assistance units  
 composition 92-07-048  
 92-10-049  
 92-07-050  
 definitions 92-07-051  
 92-10-048  
 92-10-050  
 persons included 92-07-049  
 92-10-047  
 eligibility 92-13-031  
 92-13-033  
 fair hearing process 92-11-002  
 92-14-050  
 food stamps, categorical eligibility 92-07-047  
 92-09-116  
 general assistance unemployable  
 community work experience program 92-14-094  
 92-14-095  
 incapacity, waiver of medical  
 documentation 92-02-102  
 92-04-023  
 92-08-036  
 income budgeting practices **92-15-131**  
**92-15-132**  
 resource eligibility 92-13-031  
 92-13-033

Income assistance  
 child care program 92-01-136  
 92-04-013  
 92-04-014  
 92-08-033  
 consolidated emergency assistance  
 program  
 assistance units 92-03-118  
 92-09-026  
 benefit amounts 92-03-117  
 92-09-025  
 eligibility 92-03-113  
 92-09-021  
 exempt income and resources 92-03-115  
 92-09-023  
 income determination 92-03-116  
 92-09-024  
 persons included in grant 92-03-114  
 92-09-022  
 direct rental payments to  
 landlords, pilot program 92-03-085  
 earned income disregards 92-03-090  
 funeral and interment  
 expenses 92-13-041  
 92-13-044

### SOCIAL AND HEALTH SERVICES, DEPARTMENT OF—cont.

prospective income budgeting 92-03-086  
 standards of assistance **92-15-027**  
**92-15-029**

Index of interpretive and policy  
 statements 92-09-038

Job opportunities and basic skills  
 training program (JOBS)  
 aid to families with dependent children  
 employable parent, JOBS participation 92-10-034  
 92-14-031  
 funding approval priority  
 groups 92-09-081  
 92-12-045  
**92-15-028**  
 priority of services  
 Medicaid 92-05-050  
 advance directives  
 children to eighteen years  
 of age, eligibility 92-03-083  
 cooperation in securing  
 medical support 92-03-087  
 92-03-042  
 92-03-044  
 92-07-028

Medical assistance  
 advance directives 92-05-050  
 advanced registered nurse practitioners  
 services provided 92-08-107  
 92-11-003  
 allocation of excess income, spenddown 92-03-111  
 92-03-122  
 92-07-027  
 allocation of income  
 institutionalized recipient 92-03-147  
 92-03-149  
 92-07-053  
 92-08-082  
 92-08-083  
 92-10-046  
 92-08-013  
 92-08-017  
 92-11-061  
 availability of resources 92-03-088  
 92-08-011  
 92-08-016  
 92-11-060  
 categorically needy, eligibility  
 definitions 92-03-046  
 92-04-019  
 92-13-054  
 financial responsibility of relatives 92-11-053  
 92-12-046  
 92-14-051  
 hospice services  
 eligibility 92-10-075  
 92-10-077  
 92-13-030  
 Kitsap Physicians Service—Sound Care Plan 92-10-074  
 92-10-076  
 92-13-029  
 mandatory prepaid health care plans  
 eligibility 92-10-074  
 92-10-076  
 92-13-029  
 medical care programs  
 definitions 92-04-019  
 92-13-054  
 92-05-006  
 eligibility 92-05-007  
 92-08-080  
 92-08-081  
 92-09-019  
 92-11-053  
 92-11-057  
 92-14-051  
**92-15-007**  
**92-15-009**



**Subject/Agency Index**  
(Citations in bold type refer to material in this issue)

**SOCIAL AND HEALTH SERVICES,  
DEPARTMENT OF—cont.**

excluded resources 92-02-073  
92-02-075  
92-04-025  
92-08-037  
podiatric services 92-14-079  
92-14-081  
services provided 92-01-137  
92-08-107  
92-11-003  
92-13-001  
92-14-079  
92-14-078  
92-14-078  
92-03-084  
services requiring prior approval  
x-ray services  
medical services requests  
medically indigent  
scope of care 92-01-137  
92-03-120  
92-13-001  
92-14-079  
92-14-081  
medically needy  
scope of care 92-13-001  
92-14-079  
92-14-081  
monthly maintenance standard for  
client not in own home 92-11-054  
92-12-047  
92-14-052  
oxygen service 92-03-041  
92-03-043  
92-07-026  
recovery from estates 92-03-112  
92-03-121  
92-07-029  
Mental health  
definitions 92-07-033  
92-07-034  
92-11-055  
employment services 92-07-033  
92-07-034  
92-11-055  
facilities, fees 92-06-043  
92-06-044  
92-09-118  
facilities, schedule of charges 92-14-077  
92-14-080  
regional support networks  
community support services 92-07-033  
92-07-034  
92-11-055  
Nursing facilities  
admission and screening 92-03-015  
92-08-074  
contract noncompliance 92-03-015  
92-08-074  
contractors  
projected budget 92-13-042  
92-13-043  
reimbursement rate 92-13-042  
92-13-043  
reports 92-13-042  
92-13-043  
92-13-043  
termination of contract 92-13-042  
92-13-043  
92-13-043  
placement 92-03-015  
92-08-074  
resident assessment 92-03-015  
92-08-074  
utilization review 92-03-015  
92-08-074  
Nursing homes  
pharmaceutical services 92-03-015  
92-08-074  
physician services 92-03-015  
92-08-074

**SOCIAL AND HEALTH SERVICES,  
DEPARTMENT OF—cont.**

residential care units 92-03-015  
92-08-074  
Public records  
availability 92-09-038  
disclosure exemptions 92-09-038  
fees 92-09-038  
Rules coordinator 92-03-072  
Special commitment center  
sexually violent predator  
reimbursement for law  
enforcement cost **92-15-008**  
Supplemental security income  
medical programs eligibility 92-05-006  
92-05-007  
92-09-030  
Support enforcement, office of  
assignment of support rights 92-08-001  
eligibility for services 92-08-001  
enforcement 92-08-001  
responsibilities of office 92-08-001  
support obligation 92-02-049  
92-02-050  
92-04-021  
92-08-001  
92-08-034  
92-03-089  
Vendor payments  
**SOUTH PUGET SOUND COMMUNITY  
COLLEGE**  
Meetings 92-07-003  
92-07-044  
92-11-016  
92-14-017  
**92-15-006**  
Rules coordinator  
**SOUTHWEST AIR POLLUTION CONTROL  
AUTHORITY**  
Fee schedules 92-03-078  
92-04-030  
92-06-015  
**SPOKANE, COMMUNITY COLLEGES OF**  
Adjudicative procedures 92-10-054  
92-14-039  
Employees, classified  
employment and dismissal 92-10-056  
92-14-041  
Employer-employee relations  
representing organization, election 92-10-058  
92-14-043  
Legislative liaisons 92-10-055  
92-14-040  
Parking and traffic 92-10-051  
92-14-036  
Student records, availability 92-10-057  
92-14-042  
Student rules of conduct 92-10-053  
92-14-038  
Student suspension 92-10-052  
92-14-037  
**SPOKANE COUNTY AIR POLLUTION  
CONTROL AUTHORITY**  
Air pollution sources 92-14-125  
categories, registration required 92-04-046  
Confidential information 92-07-067  
92-04-048  
92-07-069  
Penalties 92-04-045  
92-07-066  
92-04-047  
92-07-068  
Policy  
Violations  
**SUPREME COURT**  
Admission to practice  
APR 6(a) 92-06-002  
Arrest without warrant 92-13-016

**Subject/Agency Index**  
(Citations in **bold type** refer to material in this issue)

<b>SUPREME COURT—cont.</b>		<b>TRANSPORTATION IMPROVEMENT BOARD</b>	
Bar examination qualification	92-13-017	Meetings	92-02-051
Cameras in the courtroom (GR 16)	92-01-040		92-07-031
Civil rules, application of	92-14-082		92-08-095
Continuing education (APR 12)	92-13-018		92-09-027
Courts of limited jurisdiction			92-10-063
infraction rules	92-13-015		92-12-014
Criminal traffic offense cases	92-13-018		92-13-011
Evidence			<b>92-15-012</b>
admissibility	92-13-017	Rules coordinator	92-05-059
Justice court		<b>UNIVERSITY OF WASHINGTON</b>	
traffic infraction rules	92-13-015	Admission and registration	
Law clerk program fee schedule (APR 6(a))	92-07-021	procedures	92-08-065
Lawyer discipline	92-13-017		92-12-011
Limited practice board		Meetings	92-01-074
Rule 19 for APR 12	92-07-022		92-02-038
Probable cause determination	92-13-016		92-02-079
Procedures	92-13-017		92-03-021
Professional conduct	92-13-017		92-03-093
Trial, extensions of time for	92-13-016		92-03-094
			92-03-103
<b>TACOMA COMMUNITY COLLEGE</b>			92-08-042
Meetings	92-01-007		92-14-005
			<b>92-15-089</b>
<b>TAX APPEALS, BOARD OF</b>			<b>92-15-090</b>
Meetings	92-01-059		<b>92-15-091</b>
Rules coordinator	92-01-060	Registration and admission procedures	92-08-065
			92-12-011
<b>TRADE AND ECONOMIC DEVELOPMENT, DEPARTMENT OF</b>		Rules coordinator	92-02-036
Business assistance center		Stadium boat moorage facilities	92-09-154
meetings	92-03-080		92-14-060
	92-08-047		
	92-12-040	<b>USURY RATES</b>	
	92-02-015	(See inside front cover)	
Child care facility fund		<b>UTILITIES AND TRANSPORTATION COMMISSION</b>	
Community economic revitalization board		Address of commission	92-07-006
meetings	92-07-043	Administrative hearing guidelines	92-01-135
Hardwoods commission		Affiliated transactions, reporting of	92-02-080
meetings	92-06-012		92-05-001
	92-09-067		92-07-009
	92-11-015	Auto transportation companies	92-02-082
	92-13-002	Brokers and forwarders	
Rules coordinator	92-03-071	bond requirements	92-05-092
			92-09-014
<b>TRAFFIC SAFETY COMMISSION</b>		Contract carriers	
Rules coordinator	92-04-066	new contracts with shippers	92-01-053
		Electrical companies	
<b>TRANSPORTATION COMMISSION</b>		affiliated transactions, reporting of	92-02-080
Meetings	92-01-018		92-05-001
	92-01-103	Forwarders and brokers	92-07-009
	92-02-011	bond requirements	92-05-092
	92-02-012		92-09-014
	92-04-028	Gas companies	
	92-06-035	affiliated transactions, reporting of	92-02-080
	92-10-015		92-05-001
	92-12-034		92-07-009
	92-14-016	gas safety rules	92-06-086
	92-03-003	Local exchange companies	
Rules coordinator		affiliated transactions, reporting of	92-02-080
			92-05-001
<b>TRANSPORTATION, DEPARTMENT OF</b>		Log shipments, intrastate rates	92-01-051
Billboard relocation	92-06-010	Low-level radioactive waste	
	92-09-043	disposal sites and site operators	92-03-050
Bridge tolls	92-14-003	Meetings	92-01-112
	92-14-004	Motor carriers	
Ferry tolls	92-14-003	regulations	92-01-116
	92-14-004		92-02-016
Highway access management		Passenger charter carriers	92-02-082
access permits	92-10-041	Procedures	92-13-101
	92-14-044	Public records, availability	92-07-006
Highway advertising control	92-06-010	Public service companies	
	92-09-043	construction budget	92-02-083
Rules coordinator	92-03-004	Refusal of service	92-01-115
		Rules coordinator	92-01-113

**Subject/Agency Index**  
(Citations in **bold type** refer to material in this issue)

<b>UTILITIES AND TRANSPORTATION COMMISSION—cont.</b>		<b>WASHINGTON STATE UNIVERSITY</b>	
Solid waste		Meetings	92-01-086
accounts, uniform system of	92-03-082		92-09-111
annual reports	92-03-082	Rules coordinator	92-10-004
collection companies	92-01-052		92-06-016
	92-02-081	<b>WESTERN WASHINGTON UNIVERSITY</b>	
Telecommunications		Bicycles	
access charges	92-07-010	dismount zone, enforcement	92-01-073
.	92-10-067		92-06-068
automatic dialing and announcing devices	92-13-101	Meetings	92-06-006
caller identification service	92-05-089		92-07-045
	92-08-075	<b>WHATCOM COMMUNITY COLLEGE</b>	
enhanced 911 services	92-03-049	Meetings	92-03-010
interexchange telecommunications companies deposit or security	92-01-114		92-04-039
Water companies			92-09-039
"control" defined	92-05-091	Rules coordinator	<b>92-15-041</b>
	92-09-078		92-03-011
service installations and connections	92-05-090	<b>WILDLIFE, COMMISSION AND DEPARTMENT</b>	
	92-13-056	Field identification	
<b>VETERANS' AFFAIRS, DEPARTMENT OF</b>		game species and sex evidence	92-02-086
Advisory committee	92-13-022		92-05-018
Washington soldiers home and colony			92-12-057
administration	92-13-023	taxidermists and furdealers, records	92-12-064
admission eligibility	92-13-023		92-02-086
policies and procedures	92-13-023		92-05-018
resident income and assets	92-13-023		92-12-057
resident rights	92-13-023	Fishing	92-12-064
Washington veterans home administration	92-13-023	bass daily catch limits	92-05-020
admission eligibility	92-13-023		92-06-073
policies and procedures	92-13-023		92-11-079
resident income and assets	92-13-023	game fish seasons and catch limits	
resident rights	92-13-023	adoption of 1992-94	
<b>VOCATIONAL EDUCATION, COUNCIL ON</b>		regulations	92-01-084
Meetings	92-09-077	repeal of 1990-92 regulations	92-01-083
	92-10-007	game fish seasons and catch limits, 1990-92	
<b>WALLA WALLA COMMUNITY COLLEGE</b>		Big White Salmon River	92-05-022
Meetings	92-02-007	Carbon River	92-05-024
<b>WASHINGTON STATE LIBRARY</b>		Cascade River	92-02-035
Continuing education, council on membership	92-04-076	Cedar River	92-02-013
	92-08-023	Deep Creek	92-05-021
Library commission meetings	92-05-033	Green River	92-02-013
	92-09-085		92-05-019
	92-10-045	Hamilton Creek	92-08-067
Rules coordinator	92-14-034	Lake Sammamish	92-05-022
<b>WASHINGTON STATE PATROL</b>		Lake Washington	92-02-013
Approved traction tires	92-05-016	Lake Washington Ship Canal	92-02-013
Conviction records		Lewis River	92-05-022
fees	92-11-052	Nisqually River	92-03-013
	<b>92-15-015</b>	Nooksack River	92-05-019
Deceleration warning lamps	92-13-012A	Puyallup River	92-05-019
Fingerprint background checks		Rock Creek	92-05-022
fees	92-11-052	Salmon Bay	92-02-013
	<b>92-15-015</b>	Salmon Creek	92-05-022
Hazardous materials response teams vehicles		Samish River	92-02-013
flashing amber lights	92-05-015	Sammamish River	92-05-019
	92-11-032	Sauk River	92-02-013
Hazardous materials transportation	92-13-012A		92-05-019
Identification section	92-11-051	Skagit River	92-02-035
	92-13-012A		92-05-019
	<b>92-15-014</b>	Skykomish River	92-08-067
Private carrier buses	92-13-012A	Snohomish River	92-02-013
Rules coordinator	92-01-010	Snoqualmie River	92-05-019
School buses		Stillaguamish River	92-05-019
hazard strobe lamp use	92-09-050	Tokul Creek	92-02-013
Snow removal vehicles			92-05-019
traction tire use exemption	92-05-016	Washougal River	92-05-022
Towing devices and methods	92-13-012A	game fish seasons and catch limits, 1992-94	
Traction tires, approved	92-05-016	Ancient Lake	92-14-104
Trailer tongue lamps	92-13-012A		
Vehicle disposition	92-13-012A		

**Subject/Agency Index**  
(Citations in **bold type** refer to material in this issue)

**WILDLIFE, COMMISSION AND DEPARTMENT—cont.**

bass 92-06-073  
 92-11-079  
 Big White Salmon River 92-14-101  
 Bingen Lake 92-14-104  
 Buck Lake 92-14-104  
 Burke Lake 92-14-102  
 Caliche Lake 92-14-103  
 Carbon River 92-05-024  
 Clear Lake 92-02-090  
 92-07-037  
 Columbia River 92-08-064  
 Cowlitz River 92-14-100  
 Deep Creek 92-09-136  
 92-12-020  
 Echo Lake 92-02-090  
 92-07-037  
 Green River 92-05-019  
 92-08-067  
 H Lake 92-14-104  
 Kettle River 92-06-074  
 92-11-080  
 Koeneman Lake 92-14-104  
 Lake Desire 92-02-088  
 92-07-038  
 Lawrence Lake 92-14-104  
 McIntosh Lake 92-14-104  
 Morton Lake 92-02-090  
 92-07-037  
 Nooksack River 92-05-019  
 Pipers Creek 92-02-089  
 92-07-039  
 Puyallup River 92-05-019  
 Quincy Lake 92-14-102  
 Samish River 92-05-019  
 Sauk River 92-05-019  
 Serene Lake 92-02-090  
 92-07-037  
 Skagit River 92-05-019  
 92-08-067  
 Skykomish River 92-02-092  
 92-07-041  
 Snohomish River 92-05-019  
 Snoqualmie River 92-05-019  
 Stan Coffin Lake 92-14-104  
 Stillaguamish River 92-05-019  
 Tokul Creek 92-02-093  
 92-05-019  
 92-07-042  
 Tucannon River 92-14-013  
 walleye 92-02-091  
 92-07-040  
 lines and hooks, maximum number 92-06-072  
 92-08-066  
 92-11-078  
 snagging and gaffing 92-06-072  
 92-11-078  
 steelhead fishing regulations 92-05-019  
 92-05-022  
 92-05-024  
 92-08-064  
 92-08-067  
 Furdealers  
 records 92-02-086  
 92-05-018  
 92-12-057  
 92-12-064  
 Game  
 deleterious exotic wildlife  
 possession, transfer, or release  
 prohibited 92-14-015

**WILDLIFE, COMMISSION AND DEPARTMENT—cont.**

import and retention of game  
 and nonresident wildlife 92-02-086  
 92-05-018  
 92-12-057  
 92-12-064  
 92-14-014  
 possession, transfer, or release  
 of certain wildlife species 92-14-014  
 92-14-015  
 taxidermists and furdealers, records 92-02-086  
 92-05-018  
 92-12-057  
 92-12-064  
 Game management units  
 boundary descriptions 92-02-085  
 92-06-017  
 92-09-042  
 92-12-065  
 Hunting seasons  
 bear, 1991-92, 1992-93, 1993-94 92-06-075  
 92-12-058  
 Canada goose season, early closure  
 deer, 1991-92, 1992-93, 1993-94 92-01-012  
 92-06-075  
 92-06-079  
 92-12-058  
 92-12-062  
 elk, 1991-92, 1992-93, 1993-94 92-06-076  
 92-06-079  
 92-12-019  
 92-12-059  
 92-12-062  
 92-14-106  
 migratory waterfowl, 1992-93 92-14-107  
 small game, 1991-92, 1992-93, 1993-94 92-06-077  
 92-12-060  
 special closure areas, 1991-92, 1992-93 92-06-078  
 92-12-061  
 special species, 1991-92, 1992-93 92-06-080  
 92-12-063  
 turkey seasons  
 1991 spring season 92-02-094  
 92-06-019  
 1992-94 seasons 92-02-087  
 92-06-018  
 Rules coordinator 92-12-021  
 Taxidermists  
 identification of game species  
 and sex 92-02-086  
 92-05-018  
 92-12-057  
 92-12-064  
 import and retention of game  
 and nonresident wildlife 92-02-086  
 92-05-018  
 92-12-057  
 92-12-064  
 records 92-02-086  
 92-05-018  
 92-12-057  
 92-12-064  
 Trapping  
 regulations 92-14-105  
 seasons, 1992-93, 1993-94 92-14-108  
 Wildlife  
 possession, transfer, or release prohibited  
 certain species 92-14-014  
 deleterious exotic wildlife 92-14-015  
 WINE COMMISSION  
 (See AGRICULTURE, DEPARTMENT OF)

**Subject/Agency Index**  
(Citations in **bold type** refer to material in this issue)

**WORKFORCE TRAINING AND EDUCATION  
COORDINATING BOARD**  
Meetings

92-03-039  
92-09-053  
92-11-030  
92-14-058  
**92-15-096**





# WASHINGTON STATE REGISTER Subscriptions

---

To: Subscription Clerk  
WASHINGTON STATE REGISTER  
Code Reviser's Office  
PO Box 40552  
Olympia, WA 98504-0552

I would like to order \_\_\_\_\_ subscription(s) to the WASHINGTON STATE REGISTER, at an annual rate of \$161.85, sales tax included (\$150 for state agencies). Enclosed is my check or money order for \$\_\_\_\_\_. Please start my subscription with the January issue of 19\_\_\_\_.

NAME \_\_\_\_\_

ADDRESS \_\_\_\_\_

\_\_\_\_\_  
\_\_\_\_\_

THE WASHINGTON STATE REGISTER, published pursuant to RCW 34.08.020, is distributed on the first and third Wednesdays of each month. The Register contains the full text of proposed, emergency, and permanently adopted rules of state agencies, executive orders of the governor, notices of public meetings of state agencies, rules of the state supreme court, summaries of attorney general opinions, and juvenile disposition standards which have been filed in the code reviser's office prior to the pertinent closing date for that issue of the Register. A cumulative table of existing sections of the Washington Administrative Code (WAC) affected by a particular agency action guides the user to the proper volume of the Register.

The code reviser's office has established an annual subscription price of \$150 for the Register, and single copies will cost \$7. Sales tax of 7.9% now applies to all sales other than to state agencies. State law requires payment in advance. To subscribe to the Register, please complete the order form above and forward it to the address indicated, accompanied by your check or money order in the amount of \$161.85 (\$150 for state agencies) payable to the code reviser's office.

---

*Send Address Changes to:*

**WASHINGTON STATE REGISTER**

**(ISSN 0164-6389)**

**Code Reviser's Office**

**PO Box 40552**

**OLYMPIA, WA 98504-0552**



Second-Class Postage Paid At Olympia, WA
--

## S E C O N D C L A S S