

Chapter 296-54 WAC
SAFETY STANDARDS—LOGGING OPERATIONS

Last Update: 8/22/17

WAC

296-54-501	Scope and application.
296-54-503	Variance.
296-54-505	Definitions.
296-54-507	Employer's responsibilities.
296-54-509	Employee's responsibility.
296-54-511	Personal protective equipment (PPE).
296-54-51110	Head protection.
296-54-51120	Eye and face protection.
296-54-51130	Hearing protection.
296-54-51140	Hand protection.
296-54-51150	Respiratory protection.
296-54-51160	Leg protection.
296-54-51170	Foot protection.
296-54-51190	Highly visible clothing.
296-54-513	Arrangement of work areas and emergency contact.
296-54-515	Accident prevention program.
296-54-51510	Safety and health meetings.
296-54-51520	First-aid training.
296-54-51530	First-aid kits.
296-54-517	Lockout/tagout procedures.
296-54-519	Miscellaneous requirements.
296-54-520	Chain shot awareness and prevention.
296-54-52001	Chain shot awareness and prevention training.
296-54-52003	Cutting system inspection.
296-54-52005	Cutting system maintenance.
296-54-52007	Cutting system operation.
296-54-521	Motor vehicles.
296-54-523	Inspection and repair of equipment and vehicles.
296-54-527	Seat belts.
296-54-529	Overhead electrical lines clearance.
296-54-531	Truck roads.
296-54-533	Road pioneering and earthwork.
296-54-535	Hand and portable powered tools.
296-54-537	Chain saws.
296-54-539	Falling and bucking—General.
296-54-53910	Falling and bucking—Falling.
296-54-53920	Falling and bucking—Bucking.
296-54-53930	Falling and bucking—Danger trees.
296-54-53940	Falling and bucking—Springboards and tree jacking.
296-54-541	Tree pulling.
296-54-543	Mechanized falling.
296-54-545	Climbing equipment and passline.
296-54-547	Rigging—General.
296-54-54710	Rigging—Inspection.
296-54-54720	Rigging—Molles.
296-54-54730	Rigging—Shackles.
296-54-54740	Rigging—Straps.
296-54-54750	Rigging—Blocks.
296-54-54760	Rigging—Hanging blocks.
296-54-54770	Chokers and butt rigging.
296-54-549	Selecting spar, tail and intermediate support trees.
296-54-551	Raising and lowering portable spars or towers.
296-54-553	Metal spars.
296-54-555	Metal spar guyline safety straps.
296-54-557	Wire rope.
296-54-55710	Wire rope—Cutting.
296-54-55720	Wire rope—Splicing.
296-54-55730	Wire rope—Attaching end fastenings.
296-54-561	Guylines.
296-54-563	Guying tail/lift trees.
296-54-565	Intermediate support trees.
296-54-567	Rigging skylines.
296-54-569	Anchoring.
296-54-571	Releasing spiked guylines and spiked skylines from anchors.
296-54-573	Logging machines—General.
296-54-57310	Logging machines—Chipping in woods locations.
296-54-57315	Logging machines—Exhaust pipes.
296-54-57320	Logging machines—Glass.
296-54-57325	Logging machines—Brakes.
296-54-57330	Logging machines—Outriggers.
296-54-57335	Logging machines—Hydraulics.
296-54-57340	Logging machines—A-frames.
296-54-57345	Logging machines—Moving.
296-54-57350	Logging machines—Tractors and skidders.
296-54-57355	Logging machines—Protective structures for operators.
296-54-575	Landing area.
296-54-577	Yarding, skidding, landing.

296-54-579 Log decks.
296-54-581 Helicopter logging—General.
296-54-58110 Helicopter logging—Landing.
296-54-58120 Helicopter logging—Yarding.
296-54-58130 Helicopter logging—Fueling area.
296-54-583 Loading logs.
296-54-584 Tongs, hooks, grapples.
296-54-585 Cross-haul systems.
296-54-587 Self-loading log trucks.
296-54-589 Log trucks—General.
296-54-58910 Log trucks—Brakes.
296-54-58920 Log trucks—Trailer hitches and safety chains.
296-54-58930 Log trucks—Reaches and bunks.
296-54-58940 Log trucks—Stakes, stake extensions and chock blocks.
296-54-58950 Log trucks—Wrappers and binders.
296-54-58960 Log trucks—Miscellaneous requirements.
296-54-58970 Log trucks—Steered trailers.
296-54-591 Stationary log truck trailer loading.
296-54-593 Log unloading, booms, and rafting grounds—Storage and sorting areas—General.
296-54-59310 Log unloading, booms, and rafting grounds—Water dumps.
296-54-59320 Log unloading, booms, and rafting ground—Boom and rafting grounds.
296-54-59330 Log unloading, booms, and rafting grounds—Boats and mechanical devices on waters.
296-54-59340 Log unloading, booms, and rafting grounds—Dry land sorting and storage.
296-54-601 Signals and signal systems.
296-54-603 Electric signal systems.
296-54-604 Radio signaling permits.
296-54-605 Radio systems used for voice communication, activation of audible signals, or control of equipment.
296-54-607 Radio signal systems—Specifications and test procedures.
296-54-701 Wood spar trees.
296-54-70110 Wood spar trees—Guylines.
296-54-70120 Wood spar trees—Passlines.
296-54-70130 Wood spar trees—Straps.
296-54-705 Truck and equipment maintenance shops.
296-54-707 Labor camps.
296-54-99002 Appendix 1—Signals.
296-54-99003 Appendix 2—Sample minimum lockout/tagout procedure.
296-54-99004 Appendix 3—Industry consensus standards.
296-54-99013 Appendix 4—Various types of cable logging systems.
296-54-99014 Appendix 5—Wooden tree yarding and loading systems.
296-54-99015 Appendix 6—Sample chain shot training program.

DISPOSITION OF SECTIONS FORMERLY CODIFIED IN THIS CHAPTER

296-54-001 Scope and application. [Order 72-14, § 296-54-001, filed 7/31/72, effective 9/1/72; Rules (part), filed 6/2/67, effective 7/10/67.] Repealed by WSR 79-10-081 (Order 79-14), filed 9/21/79. Statutory Authority: RCW 49.17.040, 49.17.150 and 49.17.240.
296-54-003 Waiver and variance. [Order 72-14, § 296-54-003, filed 7/31/72, effective 9/1/72; Rules (part), filed 6/2/67, effective 7/10/67.] Repealed by WSR 79-10-081 (Order 79-14), filed 9/21/79. Statutory Authority: RCW 49.17.040, 49.17.150 and 49.17.240.
296-54-010 Definitions of terms used in the logging standards for the purpose of this chapter. [Order 76-29, § 296-54-010, filed 9/30/76; Order 72-14, § 296-54-010, filed 7/31/72, effective 9/1/72; Rules (part), filed 6/2/67, effective 7/10/67; Rules (part), filed 7/6/61; Rules (part), filed 3/30/62; Rules (part), filed 3/23/60.] Repealed by WSR 79-10-081 (Order 79-14), filed 9/21/79. Statutory Authority: RCW 49.17.040, 49.17.150 and 49.17.240.
296-54-020 Introduction. [Order 72-14, § 296-54-020, filed 7/31/72, effective 9/1/72; Rules (part), filed 6/2/67, effective 7/10/67; Rules (part), filed 7/6/61; Rules (part), filed 3/23/60.] Repealed by WSR 79-10-081 (Order 79-14), filed 9/21/79. Statutory Authority: RCW 49.17.040, 49.17.150 and 49.17.240.
296-54-030 Management's responsibility. [Order 72-14, § 296-54-030, filed 7/31/72, effective 9/1/72; Rules, § I, filed 6/2/67, effective 7/10/67; Rules (part), filed 7/6/61; Rules (part), filed 3/23/60.] Repealed by WSR 79-10-081 (Order 79-14), filed 9/21/79. Statutory Authority: RCW 49.17.040, 49.17.150 and 49.17.240.
296-54-040 Employee's responsibility. [Order 72-14, § 296-54-040, filed 7/31/72, effective 9/1/72; Rules, § II, filed 6/2/67, effective 7/10/67; Rules (part), filed 7/6/61; Rules (part), filed 3/23/60.] Repealed by WSR 79-10-081 (Order 79-14), filed 9/21/79. Statutory Authority: RCW 49.17.040, 49.17.150 and 49.17.240.
296-54-050 through 296-54-125. Safety and first aid. [Rules (part), filed 7/6/61, 3/23/60.] Decodified. See chapter 296-25 WAC, General safety standards.
296-54-051 Safety educational and first aid requirements. [Order 72-14, § 296-54-051, filed 7/31/72, effective 9/1/72.] Repealed by WSR 79-10-081 (Order 79-14), filed 9/21/79. Statutory Authority: RCW 49.17.040, 49.17.150 and 49.17.240.
296-54-052 General requirements. [Order 72-14, § 296-54-052, filed 7/31/72, effective 9/1/72.] Repealed by WSR 79-10-081 (Order 79-14), filed 9/21/79. Statutory Authority: RCW 49.17.040, 49.17.150 and 49.17.240.
296-54-130 Camps. [Order 72-14, § 296-54-130, filed 7/3/72, effective 9/1/72; Rules, § IV, filed 6/2/67, effective 7/10/67; Rules (part), filed 7/6/61; Rules (part), filed 3/23/60.] Repealed by WSR 79-10-081 (Order 79-14), filed 9/21/79. Statutory Authority: RCW 49.17.040, 49.17.150 and 49.17.240.

296-54-140 Railroad and truck road construction and maintenance—Railroads. [Order 72-14, § 296-54-140, filed 7/31/72, effective 9/1/72; Rules, § V (part), filed 6/2/67, effective 7/10/67; Rules (part), filed 7/6/61; Rules (part), filed 3/23/60.] Repealed by WSR 79-10-081 (Order 79-14), filed 9/21/79. Statutory Authority: RCW 49.17.040, 49.17.150 and 49.17.240.

296-54-150 Truck roads. [Order 72-14, § 296-54-150, filed 7/31/72, effective 9/1/72; Rules, § V (part), filed 6/2/67, 7/10/67; Rules (part), filed 7/6/61; Rules (part), filed 3/23/60.] Repealed by WSR 79-10-081 (Order 79-14), filed 9/21/79. Statutory Authority: RCW 49.17.040, 49.17.150 and 49.17.240.

296-54-160 Transportation of crews—General requirements. [Order 72-14, § 296-54-160, filed 7/31/72, effective 9/1/72; Rules, § VI (part), filed 6/2/67, effective 7/10/67; Rules (part), filed 7/6/61; Rules (part), filed 3/23/60.] Repealed by WSR 79-10-081 (Order 79-14), filed 9/21/79. Statutory Authority: RCW 49.17.040, 49.17.150 and 49.17.240.

296-54-170 Transportation of crews by use of speeders and trailers. [Order 72-14, § 296-54-170, filed 7/31/72, effective 9/1/72; Rules, § VI (part), filed 6/2/67, effective 7/10/67; Rules (part), filed 7/6/61, 3/23/60.] Repealed by WSR 79-10-081 (Order 79-14), filed 9/21/79. Statutory Authority: RCW 49.17.040, 49.17.150 and 49.17.240.

296-54-180 Transportation of crews by motor vehicles. [Order 72-14, § 296-54-180, filed 7/31/72, effective 9/1/72; Rules, § VI (part), filed 6/2/67, effective 7/10/67; Rules (part), filed 7/6/61; Rules (part), filed 3/23/60.] Repealed by WSR 79-10-081 (Order 79-14), filed 9/21/79. Statutory Authority: RCW 49.17.040, 49.17.150 and 49.17.240.

296-54-185 Methods of crew transportation other than those specified. [Order 72-14, § 296-54-185, filed 7/31/72, effective 9/1/72.] Repealed by WSR 79-10-081 (Order 79-14), filed 9/21/79. Statutory Authority: RCW 49.17.040, 49.17.150 and 49.17.240.

296-54-190 Rigging. [Order 72-14, § 296-54-190, filed 7/31/72, effective 9/1/72; Rules, § VIII, filed 6/2/67, effective 7/10/67; Rules (part), filed 7/6/61; Rules (part), filed 3/23/60; Addendum, filed 3/30/62.] Repealed by WSR 79-10-081 (Order 79-14), filed 9/21/79. Statutory Authority: RCW 49.17.040, 49.17.150 and 49.17.240.

296-54-195 Additional requirements for portable spars and boom type yarding and loading machines. [Order 72-14, § 296-54-195, filed 7/31/72, effective 9/1/72.] Repealed by WSR 79-10-081 (Order 79-14), filed 9/21/79. Statutory Authority: RCW 49.17.040, 49.17.150 and 49.17.240.

296-54-200 Yarding. [Order 72-14, § 296-54-200, filed 7/31/72, effective 9/1/72; Rules, § XII, filed 6/2/67, effective 7/10/67; Rules (part), filed 7/6/61; Rules (part), filed 3/23/60.] Repealed by WSR 79-10-081 (Order 79-14), filed 9/21/79. Statutory Authority: RCW 49.17.040, 49.17.150 and 49.17.240.

296-54-202 Yarding—Signal transmission, signaling equipment and related items. [Rules AB-2 through AB-11, effective 1/2/65; Rules L-4, L-5, L-6, L-16, L-22 through L-27, filed 7/6/61; Rules (part), filed 3/23/60.] Superseded by Rules, filed 6/27/67, effective 7/10/67. See WAC 296-54-350 through 296-54-393.

296-54-210 Tractor logging. [Order 72-14, § 296-54-210, filed 7/31/72, effective 9/1/72; Rules, § XIII, filed 6/2/67, effective 7/10/67; Rules (part), filed 7/6/61; Rules (part), filed 3/23/60.] Repealed by WSR 79-10-081 (Order 79-14), filed 9/21/79. Statutory Authority: RCW 49.17.040, 49.17.150 and 49.17.240.

296-54-215 Canopy guards, barricades, seat belts, screens and other items required for industrial equipment. [Order 72-14, § 296-54-215, filed 7/31/72, effective 9/1/72.] Repealed by WSR 79-10-081 (Order 79-14), filed 9/21/79. Statutory Authority: RCW 49.17.040, 49.17.150 and 49.17.240.

296-54-216 Roll-over protective structures and overhead protection. [Order 72-14, § 296-54-216, filed 7/31/72, effective 9/1/72.] Repealed by WSR 79-10-081 (Order 79-14), filed 9/21/79. Statutory Authority: RCW 49.17.040, 49.17.150 and 49.17.240.

296-54-217 Braking systems for tractors and other mobile equipment. [Order 72-14, § 296-54-217, filed 7/31/72, effective 9/1/72.] Repealed by WSR 79-10-081 (Order 79-14), filed 9/21/79. Statutory Authority: RCW 49.17.040, 49.17.150 and 49.17.240.

296-54-218 Emergency steering. [Order 72-14, § 296-54-218, filed 7/31/72, effective 9/1/72.] Repealed by WSR 79-10-081 (Order 79-14), filed 9/21/79. Statutory Authority: RCW 49.17.040, 49.17.150 and 49.17.240.

296-54-220 Log loading. [Order 72-14, § 296-54-220, filed 7/31/72, effective 9/1/72; Rules, § XIV, filed 6/2/67, effective 7/10/67; Rules (part), filed 7/6/61; Rules (part), filed 3/23/60.] Repealed by WSR 79-10-081 (Order 79-14), filed 9/21/79. Statutory Authority: RCW 49.17.040, 49.17.150 and 49.17.240.

296-54-230 Lines, blocks and shackles. [Order 72-14, § 296-54-230, filed 7/31/72, effective 9/1/72; Rules, § IX, filed 6/2/67, effective 7/10/67; Rules (part), filed 7/6/61; Rules (part), filed 3/23/60.] Repealed by WSR 79-10-081 (Order 79-14), filed 9/21/79. Statutory Authority: RCW 49.17.040, 49.17.150 and 49.17.240.

296-54-240 Yarding, loading, and skidding units. [Order 72-14, § 296-54-240, filed 7/31/72, effective 9/1/72; Rules, § X, filed 6/2/67, effective 7/10/67; Rules (part), filed 7/6/61; Rules (part), filed 3/23/60.] Repealed by WSR 79-10-081 (Order 79-14), filed 9/21/79. Statutory Authority: RCW 49.17.040, 49.17.150 and 49.17.240.

296-54-250 New and used boiler or pressure vessels. [Rules (part), filed 7/6/61, 3/23/60.] Superseded by Rules, filed 6/27/67, effective 7/10/67. See WAC 296-54-240(9) and chapter 70.79 RCW.

296-54-260 Falling—Bucking. [Order 72-14, § 296-54-260, filed 7/31/72, effective 9/1/72; Rules, § VII, filed 6/2/67, effective 7/10/67; Rules (part), filed 7/6/61; Rules (part), filed 3/23/60.] Repealed by WSR 79-10-081 (Order 79-14), filed 9/21/79. Statutory Authority: RCW 49.17.040, 49.17.150 and 49.17.240.

296-54-270 Moving machines. [Order 72-14, § 296-54-270, filed 7/31/72, effective 9/1/72; Rules, § XI, filed 6/2/67, effective 7/10/67; Rules (part), filed 7/6/61; Rules (part), filed

3/23/60.] Repealed by WSR 79-10-081 (Order 79-14), filed 9/21/79. Statutory Authority: RCW 49.17.040, 49.17.150 and 49.17.240.

296-54-280 General requirements. [Order 76-29, § 296-54-280, filed 9/30/76; Order 72-14, § 296-54-280, filed 7/31/72, effective 9/1/72; Rules, § XIX, filed 6/2/67, effective 7/10/67; Rules (part), filed 7/6/61; Rules (part), filed 3/23/60.] Repealed by WSR 79-10-081 (Order 79-14), filed 9/21/79. Statutory Authority: RCW 49.17.040, 49.17.150 and 49.17.240.

296-54-281 Water dumps. [Order 72-14, § 296-54-281, filed 7/31/72, effective 9/1/72.] Repealed by WSR 79-10-081 (Order 79-14), filed 9/21/79. Statutory Authority: RCW 49.17.040, 49.17.150 and 49.17.240.

296-54-282 Boom and rafting grounds. [Order 76-7, § 296-54-282, filed 3/1/76; Order 72-14, § 296-54-282, filed 7/31/72, effective 9/1/72.] Repealed by WSR 79-10-081 (Order 79-14), filed 9/21/79. Statutory Authority: RCW 49.17.040, 49.17.150 and 49.17.240.

296-54-284 Dry land sorting and storage. [Order 72-14, § 296-54-284, filed 7/31/72, effective 9/1/72.] Repealed by WSR 79-10-081 (Order 79-14), filed 9/21/79. Statutory Authority: RCW 49.17.040, 49.17.150 and 49.17.240.

296-54-286 Boats and mechanical devices on water. [Order 76-7, § 296-54-286, filed 3/1/76; Order 72-14, § 296-54-286, filed 7/31/72, effective 9/1/72.] Repealed by WSR 79-10-081 (Order 79-14), filed 9/21/79. Statutory Authority: RCW 49.17.040, 49.17.150 and 49.17.240.

296-54-290 Electrical logging equipment. [Rules (part), filed 7/6/61; Rules (part), filed 3/23/60.] Repealed by WSR 79-10-081 (Order 79-14), filed 9/21/79. Statutory Authority: RCW 49.17.040, 49.17.150 and 49.17.240.

296-54-300 Explosives. [Order 72-14, § 296-54-300, filed 7/31/72, effective 9/1/72; Rules, § XX, filed 6/2/67, effective 7/10/67; Rules (part), filed 7/6/61; Rules (part), filed 3/23/60.] Repealed by WSR 79-10-081 (Order 79-14), filed 9/21/79. Statutory Authority: RCW 49.17.040, 49.17.150 and 49.17.240.

296-54-310 Railroad operations. [Order 72-14, § 296-54-310, filed 7/31/72, effective 9/1/72; Rules, § XVI, filed 6/2/67, effective 7/10/67; Rules (part), filed 7/6/61; Rules (part), filed 3/23/60.] Repealed by WSR 79-10-081 (Order 79-14), filed 9/21/79. Statutory Authority: RCW 49.17.040, 49.17.150 and 49.17.240.

296-54-320 Railroad maintenance, loading or unloading. [Order 72-14, § 296-54-320, filed 7/31/72, effective 9/1/72; Rules, § XVII, filed 6/2/67, effective 7/10/67; Rules (part), filed 7/6/61; Rules (part), filed 3/23/60.] Repealed by WSR 79-10-081 (Order 79-14), filed 9/21/79. Statutory Authority: RCW 49.17.040, 49.17.150 and 49.17.240.

296-54-330 Motor truck log transportation. [Order 72-14, § 296-54-330, filed 7/31/72, effective 9/1/72; Rules, § XV, filed 6/2/67, effective 7/10/67; Rules (part), filed 7/6/61; Rules (part), filed 3/23/60.] Repealed by WSR 79-10-081 (Order 79-14), filed 9/21/79. Statutory Authority: RCW 49.17.040, 49.17.150 and 49.17.240.

296-54-335 Stationary log truck trailer loading. [Order 72-14, § 296-54-335, filed 7/31/72, effective 9/1/72.] Repealed by WSR 79-10-081 (Order 79-14), filed 9/21/79. Statutory Authority: RCW 49.17.040, 49.17.150 and 49.17.240.

296-54-340 Maintenance shops. [Order 72-14, § 296-54-340, filed 7/31/72, effective 9/1/72; Rules, § XVIII, filed 6/2/67, effective 7/10/67; Rules (part), filed 7/6/61; Rules (part), filed 3/23/60.] Repealed by WSR 79-10-081 (Order 79-14), filed 9/21/79. Statutory Authority: RCW 49.17.040, 49.17.150 and 49.17.240.

296-54-350 Signals and signal systems. [Order 72-14, § 296-54-350, filed 7/31/72, effective 9/1/72; Rules, § XXI (part), filed 6/2/67, effective 7/10/67; Rules (part), filed 7/6/61; Rules (part), filed 3/23/60.] Repealed by WSR 79-10-081 (Order 79-14), filed 9/21/79. Statutory Authority: RCW 49.17.040, 49.17.150 and 49.17.240.

296-54-360 Skidder whistle signals. [Order 72-14, § 296-54-360, filed 7/31/72, effective 9/1/72; Rules, § XXI (part), filed 6/2/67, effective 7/10/67; Rules (part), filed 7/6/61; Rules (part), filed 3/23/60.] Repealed by WSR 79-10-081 (Order 79-14), filed 9/21/79. Statutory Authority: RCW 49.17.040, 49.17.150 and 49.17.240.

296-54-370 Slackline whistle signals. [Order 72-14, § 296-54-370, filed 7/31/72, effective 9/1/72; Rules, § XXI (part), filed 6/2/67, effective 7/10/67; Rules (part), filed 7/6/61; Rules (part), filed 3/23/60.] Repealed by WSR 79-10-081 (Order 79-14), filed 9/21/79. Statutory Authority: RCW 49.17.040, 49.17.150 and 49.17.240.

296-54-380 High lead logging whistle signals. [Order 72-14, § 296-54-380, filed 7/31/72, effective 9/1/72; Rules, § XXI (part), filed 6/2/67, effective 7/10/67; Rules AB-1, effective 1/2/65; Rule Z-3, filed 7/6/61; Rules (part), filed 3/23/60.] Repealed by WSR 79-10-081 (Order 79-14), filed 9/21/79. Statutory Authority: RCW 49.17.040, 49.17.150 and 49.17.240.

296-54-390 High lead whistle signal—General whistle signals. [Rules (part), filed 7/6/61, 3/23/60.] Superseded by Rules, filed 6/27/67, effective 7/10/67. For later enactment see WAC 296-54-391 through 296-54-393.

296-54-391 General requirements for signaling and signal equipment. [Rules, § XXI (part), filed 6/2/67, effective 7/10/67.] Repealed by omission, Order 72-14, filed 7/31/72.

296-54-392 Electric signal systems. [Order 72-14, § 296-54-392, filed 7/31/72, effective 9/1/72; Rules, § XXI (part), filed 6/2/67, effective 7/10/67.] Repealed by WSR 79-10-081 (Order 79-14), filed 9/21/79. Statutory Authority: RCW 49.17.040, 49.17.150 and 49.17.240.

296-54-393 Radio systems used for voice communications, activation of audible signals or equipment. [Order 72-14, § 296-54-393, filed 7/31/72, effective 9/1/72; Rules, § XXI (part), filed 6/2/67, effective 7/10/67.] Repealed by WSR 79-10-081 (Order 79-14), filed 9/21/79. Statutory Authority: RCW 49.17.040, 49.17.150 and 49.17.240.

296-54-39301 Form No. 157—Application for permit to operate radio signal system in designated area. [Order 72-14, Form No. 157 (codified as WAC 296-54-39301), filed 7/31/72, effective 9/1/72.] Repealed by WSR 79-10-081 (Order 79-14), filed 9/21/79. Statutory Authority: RCW 49.17.040, 49.17.150 and 49.17.240.

296-54-399 Special rigging standards. [Rules (part), filed 7/6/61, 3/23/60. Recodified from WAC 296-54-400 to avoid duplication of numbering.] Superseded by Rules, filed 6/27/67, effective 7/10/67. See WAC 296-54-190.

296-54-400 Radio-signaling systems—Minimum requirements. [Order 72-14, § 296-54-400, filed 7/31/72, effective 9/1/72.] Repealed by WSR 79-10-081 (Order 79-14), filed 9/21/79. Statutory Authority: RCW 49.17.040, 49.17.150 and 49.17.240.

296-54-450 Rules and regulations of the state board of health concerning labor camps. [Rules (part), filed 7/6/61, 3/23/60.] Decodified. See WAC 296-54-130, and chapters 296-26 and 248-60 WAC.

296-54-45001 Pulpwood logging. [Statutory Authority: Chapter 49.17 RCW. WSR 88-23-054 (Order 88-25), § 296-54-45001, filed 11/14/88; Order 76-7, § 296-54-45001, filed 3/1/76; Order 74-20, § 296-54-450 (codified as WAC 296-54-45001), filed 5/6/74.] Repealed by WSR 96-22-013, filed 10/28/96, effective 1/1/97. Statutory Authority: RCW 49.17.040, [49.17].050 and [49.17].060.

296-54-51180 Personal flotation devices. [Statutory Authority: RCW 49.17.010, [49.17].040 and [49.17].050. WSR 99-17-117, § 296-54-51180, filed 8/18/99, effective 12/1/99.] Repealed by WSR 06-07-142, filed 3/21/06, effective 5/1/06. Statutory Authority: RCW 49.17.010, 49.17.040, 49.17.050, 49.17.060.

296-54-525 Railroad construction and maintenance. [Statutory Authority: RCW 49.17.040, 49.17.150 and 49.17.240. WSR 79-10-081 (Order 79-14), § 296-54-525, filed 9/21/79.] Repealed by WSR 99-17-117, filed 8/18/99, effective 12/1/99. Statutory Authority: RCW 49.17.010, [49.17].040, and [49.17].050.

296-54-559 Yarding—Helicopters and helicopter cranes. [Statutory Authority: RCW 49.17.040, [49.17].050 and [49.17].060. WSR 96-22-013, § 296-54-559, filed 10/28/96, effective 1/1/97. Statutory Authority: Chapter 49.17 RCW. WSR 88-23-054 (Order 88-25), § 296-54-559, filed 11/14/88. Statutory Authority: RCW 49.17.040 and 49.17.050. WSR 81-05-013 (Order 81-3), § 296-54-559, filed 2/10/81. Statutory Authority: RCW 49.17.040, 49.17.150 and 49.17.240. WSR 79-10-081 (Order 79-14), § 296-54-559, filed 9/21/79.] Amended and decodified by WSR 99-17-117, filed 8/18/99, effective 12/1/99. Statutory Authority: RCW 49.17.010, [49.17].040 and [49.17].050.

296-54-595 Transporting crews. [Statutory Authority: RCW 49.17.010, [49.17].040 and [49.17].050. WSR 99-17-117, § 296-54-595, filed 8/18/99, effective 12/1/99. Statutory Authority: RCW 49.17.040, [49.17].050 and [49.17].060. WSR 96-22-013, § 296-54-595, filed 10/28/96, effective 1/1/97. Statutory Authority: RCW 49.17.040, 49.17.050, 49.17.240, chapters 43.22 and 42.30 RCW. WSR 80-11-057 (Order 80-15), § 296-54-595, filed 8/20/80. Statutory Authority: RCW 49.17.040, 49.17.150 and 49.17.240. WSR 79-10-081 (Order 79-14), § 296-54-595, filed 9/21/79.] Repealed by WSR 17-17-131, filed 8/22/17, effective 10/22/17. Statutory Authority: RCW 49.17.010, 49.17.040, 49.17.050, 49.17.060, and chapter 49.17 RCW.

296-54-59510 Speeders used to transport crews. [Statutory Authority: RCW 49.17.010, [49.17].040 and [49.17].050. WSR 99-17-117, § 296-54-59510, filed 8/18/99, effective 12/1/99.] Repealed by WSR 17-17-131, filed 8/22/17, effective 10/22/17. Statutory Authority: RCW 49.17.010, 49.17.040, 49.17.050, 49.17.060, and chapter 49.17 RCW.

296-54-59520 Trailers used to transport crews. [Statutory Authority: RCW 49.17.010, [49.17].040 and [49.17].050. WSR 99-17-117, § 296-54-59520, filed 8/18/99, effective 12/1/99.] Repealed by WSR 17-17-131, filed 8/22/17, effective 10/22/17. Statutory Authority: RCW 49.17.010, 49.17.040, 49.17.050, 49.17.060, and chapter 49.17 RCW.

296-54-597 Railroads. [Statutory Authority: RCW 49.17.010, [49.17].040 and [49.17].050. WSR 99-17-117, § 296-54-597, filed 8/18/99, effective 12/1/99. Statutory Authority: RCW 49.17.040, [49.17].050 and [49.17].060. WSR 96-22-013, § 296-54-597, filed 10/28/96, effective 1/1/97. Statutory Authority: RCW 49.17.040, 49.17.150 and 49.17.240. WSR 79-10-081 (Order 79-14), § 296-54-597, filed 9/21/79.] Repealed by WSR 17-17-131, filed 8/22/17, effective 10/22/17. Statutory Authority: RCW 49.17.010, 49.17.040, 49.17.050, 49.17.060, and chapter 49.17 RCW.

296-54-59710 Railroad construction and maintenance. [Statutory Authority: RCW 49.17.010, [49.17].040 and [49.17].050. WSR 99-17-117, § 296-54-59710, filed 8/18/99, effective 12/1/99.] Repealed by WSR 17-17-131, filed 8/22/17, effective 10/22/17. Statutory Authority: RCW 49.17.010, 49.17.040, 49.17.050, 49.17.060, and chapter 49.17 RCW.

296-54-59720 Railroad operations. [Statutory Authority: RCW 49.17.010, [49.17].040 and [49.17].050. WSR 99-17-117, § 296-54-59720, filed 8/18/99, effective 12/1/99.] Repealed by WSR 17-17-131, filed 8/22/17, effective 10/22/17. Statutory Authority: RCW 49.17.010, 49.17.040, 49.17.050, 49.17.060, and chapter 49.17 RCW.

296-54-59730 Railroad maintenance—Loading or unloading. [Statutory Authority: RCW 49.17.010, [49.17].040 and [49.17].050. WSR 99-17-117, § 296-54-59730, filed 8/18/99, effective 12/1/99.] Repealed by WSR 17-17-131, filed 8/22/17, effective 10/22/17. Statutory Authority: RCW 49.17.010, 49.17.040, 49.17.050, 49.17.060, and chapter 49.17 RCW.

296-54-599 Truck and equipment maintenance shops. [Statutory Authority: RCW 49.17.040, 49.17.150 and 49.17.240. WSR 79-10-081 (Order 79-14), § 296-54-599, filed 9/21/79.] Repealed by WSR 99-17-117, filed 8/18/99, effective 12/1/99. Statutory Authority: RCW 49.17.010, [49.17].040 and [49.17].050.

296-54-990 Map. [Order 72-14, Map (codified as WAC 296-54-990), filed 7/31/72, effective 9/1/72.] Repealed by WSR 88-23-054 (Order 88-25), filed 11/14/88. Statutory Authority: Chapter 49.17 RCW.

296-54-99001 Appendix I—Figure 1—Rigging up, wrapping a guyline. [Order 72-14, Figure 1 (codified as WAC 296-54-99001), filed 7/31/72, effective 9/1/72.] Repealed by WSR 88-23-054 (Order 88-25), filed 11/14/88. Statutory Authority: Chapter 49.17 RCW.

296-54-99005 Appendix I—Figure 5—Standard signals for tractor logging. [Order 72-14, Figure 5 (codified as WAC 296-54-99005), filed 7/31/72, effective 9/1/72.] Repealed by WSR 88-23-054 (Order 88-25), filed 11/14/88. Statutory Authority: Chapter 49.17 RCW.

- 296-54-99006 Appendix I—Figure 6—Standard signals for loading logs. [Order 72-14, Figure 6 (codified as WAC 296-54-99006), filed 7/31/72, effective 9/1/72.] Repealed by WSR 88-23-054 (Order 88-25), filed 11/14/88. Statutory Authority: Chapter 49.17 RCW.
- 296-54-99007 Appendix I—Figure 7—Heel boom loading. [Order 72-14, Figure 7 (codified as WAC 296-54-99007), filed 7/31/72, effective 9/1/72.] Repealed by WSR 99-22-045, filed 10/29/99, effective 12/1/99. Statutory Authority: RCW 49.17.010, [49.17].040 and [49.17].050.
- 296-54-99008 Appendix I—Figure 8—Guyline loading. [Order 72-14, Figure 8 (codified as WAC 296-54-99008), filed 7/31/72, effective 9/1/72.] Repealed by WSR 99-22-045, filed 10/29/99, effective 12/1/99. Statutory Authority: RCW 49.17.010, [49.17].040 and [49.17].050.
- 296-54-99009 Appendix I—Figure 9—Hayrack boom loading. [Order 72-14, Figure 9 (codified as WAC 296-54-99009), filed 7/31/72, effective 9/1/72.] Repealed by WSR 99-22-045, filed 10/29/99, effective 12/1/99. Statutory Authority: RCW 49.17.010, [49.17].040 and [49.17].050.
- 296-54-99010 Appendix I—Figure 10—Spreader bar loading. [Order 72-14, Figure 10 (codified as WAC 296-54-99010), filed 7/31/72, effective 9/1/72.] Repealed by WSR 99-22-045, filed 10/29/99, effective 12/1/99. Statutory Authority: RCW 49.17.010, [49.17].040 and [49.17].050.
- 296-54-99011 Appendix I—Figure 11—Placement and number of binders. [Order 72-14, Figure 11 (codified as WAC 296-54-99011), filed 7/31/72, effective 9/1/72.] Repealed by WSR 88-23-054 (Order 88-25), filed 11/14/88. Statutory Authority: Chapter 49.17 RCW.
- 296-54-99012 Appendix I—Figure 12—Standard signals for high lead logging. [Order 72-14, Figure 12 (codified as WAC 296-54-99012), filed 7/31/72, effective 9/1/72.] Repealed by WSR 88-23-054 (Order 88-25), filed 11/14/88. Statutory Authority: Chapter 49.17 RCW.

WAC 296-54-501 Scope and application. This chapter establishes safety practices for all types of logging operations, log road construction and other similar activities. This chapter does not apply to log handling at sawmills, plywood mills, pulp mills, or other manufacturing operations governed by specific safety standards. This chapter provides minimum safety requirements for the logging industry. The logging industry is also covered by the general safety standards, chapter 296-24 WAC; occupational health standards, chapter 296-62 WAC; the safety and health core rules, chapter 296-800 WAC; or others that may apply. Chapter 296-52 WAC, which covers the possession, handling and use of explosives, applies when explosives are used in logging operations.

[Statutory Authority: RCW 49.17.010, 49.17.040, 49.17.050, 49.17.060, and chapter 49.17 RCW. WSR 17-17-131, § 296-54-501, filed 8/22/17, effective 10/22/17. Statutory Authority: RCW 49.17.010, [49.17].040, and [49.17].050. WSR 01-11-038, § 296-54-501, filed 5/9/01, effective 9/1/01; WSR 99-17-117, § 296-54-501, filed 8/18/99, effective 12/1/99. Statutory Authority: RCW 49.17.040, [49.17].050 and [49.17].060. WSR 96-22-013, § 296-54-501, filed 10/28/96, effective 1/1/97. Statutory Authority: Chapter 49.17 RCW. WSR 88-23-054 (Order 88-25), § 296-54-501, filed 11/14/88. Statutory Authority: RCW 49.17.040, 49.17.150 and 49.17.240. WSR 79-10-081 (Order 79-14), § 296-54-501, filed 9/21/79.]

WAC 296-54-503 Variance. If you find it impractical to comply with specific requirements of this chapter, the department may permit a variation from the requirements. However, you must still provide equal protection by substitute means. To request a variance, write to:

WISHA Services Division—Variance Request
 Department of Labor & Industries
 P.O. Box 44650
 Olympia, WA 98504-4650

[Statutory Authority: RCW 49.17.010, 49.17.040, 49.17.050, 49.17.060, and chapter 49.17 RCW. WSR 17-17-131, § 296-54-503, filed 8/22/17, effective 10/22/17. Statutory Authority: RCW 49.17.010, [49.17].040 and [49.17].050. WSR 99-17-117, § 296-54-503, filed 8/18/99, effective 12/1/99. Statutory Authority: RCW 49.17.040, 49.17.150 and 49.17.240. WSR 79-10-081 (Order 79-14), § 296-54-503, filed 9/21/79.]

WAC 296-54-505 Definitions. A-frame. A structure made of two independent columns fastened together at the top and separated by a reasonable width at the bottom to stabilize the unit from tipping sideways.

An operation. Any place where logging or log related activities are taking place.

Approved. Approved by the department of labor and industries.

Arch. Any device attached to the back of a vehicle and used for raising one end of logs to facilitate movement.

Authorized person. A person approved or assigned by the employer to perform a specific type of duty(s) or to be at a specific location at a certain time(s).

Backcut (felling cut). The cut in a felling operation made on the opposite side from the undercut.

Backline. The portion of the haulback that runs between the spar/spar tree and the corner block.

Ballistic nylon. A nylon fabric of high tensile properties designed to provide protection from lacerations.

Barrier. A fence, wall or railing to prevent passage or approach.

Base of tree. That portion of a natural tree not more than three feet above ground level.

Bight of the line. A hazardous zone created by running lines under tension. Any section of a line between the ends.

Binder. A hinged lever assembly for connecting the ends of a wrapper to tighten the wrapper around the load of logs or materials.

Boomboat. Any boat used to push or pull logs, booms, bundles, or bags, in booming ground operations.

Boomscooter. A small boat, usually less than fourteen feet in length, equipped with an outboard motor, having directional pushing capabilities of 360 degrees.

Brailing. When tiers of logs, poles, or piles are fastened together with a type of dogline and the ends of the side members are then fastened together for towing.

Brow log. A log or a suitable substitute placed parallel to any roadway at a landing or dump to protect the carrier and facilitate the safe loading or unloading of logs, timber products, or materials.

Buck. Means the process of severing a tree into sections (logs or bolts).

Butt. The bottom of the felled part of a tree.

Butt welding. The practice of welding something end to end.

Cable tree thinning. The selective thinning of a timber stand using mobile yarding equipment specifically designed or adapted for the purpose. Cable tree thinning includes skyline, slackline, or modified slackline, overhead cable systems.

Cable yarding. The movement of felled trees or logs from the area where they are felled to the landing on a system composed of a cable suspended from spars and/or towers. The trees or logs may be either

dragged across the ground on the cable or carried while suspended from the cable.

Chain shot. When the saw chain breaks, when using a mechanical timber harvester or processor, fragments or pieces are projected with tremendous force, and can travel a distance greater than 250 feet.

Chain shot danger zone or shot cone zone. The area included within 15 degrees on either side of the guide bar and up to a distance of at least 250 feet.

Chock. A block, often wedge shaped, which is used to prevent movement; e.g., a log from rolling, a wheel from turning.

Choker. A length of wire rope with attachments for encircling the end of a log to be yarded.

Chunking. To clear nonusable material from a specified area.

Cold deck. A pile of yarded logs left for future removal.

Competent person. One who is capable of identifying hazards in the surroundings or working conditions which are unsanitary, hazardous or dangerous.

Corner block. The first block the haulback passes through on its way to the tail block.

Crotch line. Two short lines attached to the same ring or shackle, used for loading or unloading.

Cutter. An employee whose primary job is to fall, buck, or limb trees before they are moved to the landing area.

Danger trees. Any tree of any height, dead or alive, that presents a hazard to workers because of rot, root, stem or limb damage, lean, or any other observable condition created by natural process or man-made activity.

DBH. Diameter at breast height.

Deadman. Buried log or other object used as an anchor.

Debark. To remove bark from trees or logs. Debark generally denotes mechanical means as opposed to manual peeling.

Deck. A stack of trees or logs.

Designated person. An employee who has the requisite knowledge, training, and experience to perform specific duties.

Directional falling. A mechanical means to control the direction of falling timber.

Domino felling. The partial cutting of multiple trees which are left standing and then pushed over with a pusher tree.

Donkey. Any machine with a series of drums used to yard logs.

Double ended logs. Two logs end to end on the same lay.

Drop zone. The area where the helicopter delivers logs from the logging site.

Droplines. A short line attached to the carriage or carriage block which is used as an extension to the main line.

Drum. A mechanical device on which line is spooled or unspooled.

Dry land storage. Decks of logs stored for future removal or use.

Dutchman.

(a) A block used to change direction of line lead (sideblocking).

(b) A method used to pull a tree against its lean by leaving a section of the undercut on one corner of the face. The portion left consists of a single saw kerf in one side of the face, with the face completely removed on the opposite side of the face cut. A single saw kerf must never extend completely across the stump.

Experienced person. A person who has been trained and has participated in the subject process for a period of time long enough to thoroughly acquaint the person with all facets of the process.

F.O.P.S. Falling object protective structure.

Fair lead. Sheaves, rolls, or a combination thereof arranged to receive a line coming from any direction for proper line spooling on to a drum.

Fell (fall). To cut down trees.

Feller (faller). An employee who fells trees.

Front end loader. A mobile machine mounted on a wheeled or tracked chassis, equipped with a grapple, tusk, bucket, or fork-lift device, and employed in the loading, unloading, stacking, or sorting of logs or materials.

Grounded. The placement of a component of a machine on the ground or on a device where it is firmly supported. Grounded may also relate to the placement of a tree on the ground or a method to dissipate static or electrical charges.

Guarded. Covered, shielded, fenced, enclosed, or otherwise protected by means of suitable enclosures, covers, casings, shields, troughs, railings, screens, mats, or platforms, or by location, to prevent injury.

Guard rail. A railing to restrain a person.

Guyline. A line used to support or stabilize a spar, tail/lift tree, intermediate support tree or equipment. A guyline is considered a standing line.

Gypsy drum. A mechanical device wherein the line is not attached to the drum and is manually spooled to control the line movement on and off the drum.

Haulback. A line used to pull the buttrigging and mainline to the logs to be yarded.

Haulback block. Any block the haulback line passes through including the corner block and tailblock.

Hay rack.

(a) A type of loading boom where two tongs are used and logs are suspended.

(b) A transporting vehicle with multiple sets of bunks attached to a rigid frame usually used for hauling logs.

Haywire. See strawline.

Hazardous falling area. The area within a circle centered on the tree being felled and having a radius not less than twice the height of that tree.

Head tree. The tree where yarding and/or loading takes place. (See spar)

Heel boom. A type of loading boom where one tong is used and one end of the log is pulled up against the boom.

High lead. A system of logging wherein the main line is threaded through the main line block, which is attached near the top of the spar, to obtain a lift of the logs being yarded.

High visibility colors. White, bright, or fluorescent colors that stand out from the surrounding background color so they are easily seen.

Hobo log and/or hitchhiker. A free or unattached log that is picked up by a turn and is transported with the turn.

Hooktender. The worker that supervises the method of moving the logs from the woods to the landing.

Hot deck. A landing where logs are being moved.

Hydraulic jack. A mechanical device, powered by internal pressure, used to control the direction in which a tree is to be felled.

In the clear. A position within the work area where the probability of hazardous contact with falling trees, moving logs, rootwads, chunks, material, rigging and equipment is minimized by distance from

the hazards and/or use of physical barriers, such as stumps, trees, terrain or other objects providing protection.

Examples:

(a) Back behind on the uphill side of the turn and out of reach of any upending logs.

(b) Out of the bight.

(c) In the logged off area.

(d) In a position where movement will not be obstructed.

Intermediate support system. A system for supporting a loaded skyline in a support jack by one of the two following methods:

(a) Double tree support - The skyline is suspended on a single piece of wire rope supported by two trees so that the load is shared between the two trees.

(b) Single tree support - The skyline is suspended on a single piece of wire rope, single-eyed choker or double-eyed strap supported by a single tree. The support tree may be vertical or leaning.

Jackstrawed. Trees or logs piled in an unorderly manner.

Jaggers. Any projecting broken wire in a strand of cable.

Kerf. The part of timber products taken out by the saw teeth.

Knob. A metal ferrule attached to the end of a line.

Landing. Any place where logs are laid after being yarded, awaiting subsequent handling, loading, and hauling.

Landing chute. The head of the skid trail or road where the logs are temporarily placed before handling, loading and hauling.

Lay.

(a) The straight-line distance it takes a strand of wire rope to make one complete spiral around the core of a rope.

(b) The position of a log in a pile, on a load, or in the fell and bucked.

Limbing. To cut branches off felled or standing trees.

Loading boom. Any structure projecting from a pivot point to guide a log when lifted.

Lodged tree (hung tree). A tree leaning against another tree or object which prevents it from falling to the ground.

Log. A tree segment suitable for subsequent processing into lumber, pulpwood, or other wood products, including, but not limited to, poles, piling, peeler blocks, sections and/or bolts.

Log bronco. A sturdily built boat usually from twelve to twenty feet in length, used to push logs or bundles of logs in a generally forward direction in booming and rafting operations.

Log dump. A place where logs are removed from transporting equipment. It may be either dry land or water, parbuckled over a brow log or removed by machine.

Log stacker. A mobile machine mounted on a wheeled or tracked chassis, equipped with a frontally mounted grapple, tusk, or forklift device, and employed in the loading, unloading, stacking, or sorting of logs.

Logging machine. A machine used or intended for use to yard, move, or handle logs, trees, chunks, trailers, and related materials or equipment.

Note: A self-loading log truck is only considered a logging machine when in use for loading and unloading.

Note: A helicopter is not considered a logging machine.

Logging operations. Operations associated with felling and/or moving trees, logs, veneer bolts, poles, pilings, and other forest products from the stump to the point of delivery. Such operations are such, but not limited to, marking, felling, bucking, limbing, debark-

ing, chipping, yarding, loading, unloading, storing, and the transporting of machines, equipment and personnel from one site to another.

Long sticks. An overlength log or tree length that creates a hazard by exceeding the safe perimeters of the landing.

Machine. A piece of stationary or mobile equipment having a self-contained power plant, that is operated off-road and used for the movement of material. Machines include but are not limited to tractors, skidders, front-end loaders, scrapers, graders, bulldozers, rough terrain logging shovels, log stackers and mechanical felling devices, such as tree shears and feller-bunchers.

Mainline. The line attached to the buttrigging used to pull logs to the landing.

Mainline block. The block hung in the portable spar or tower through which the mainline passes.

Matchcutting. The felling of trees without using an undercut.

Mechanized falling. Falling of standing timber by a self-propelled mobile wheeled or tracked machine equipped with a shear or other powered cutting device.

Mechanized feller. Any such machine as described in WAC 296-54-541 and 296-54-543, and includes feller/bunchers and similar machines performing multiple functions.

Mechanized logging machine. A feller-buncher, single-grip harvester, processor, forwarder, clambunk, or log loader.

Mobile log loader. A self-propelled log loading machine mounted on wheels or tracks, incorporating a boom and employed in the loading or unloading of logs by means of grapples or tongs.

Mobile yarder. A logging machine mounted on wheels, tracks, or skids, incorporating a vertical or inclined spar, tower, or boom, employed in skyline, slackline, high lead or grapple overhead cable logging systems.

Molle. A single strand of wire rope rolled into a circle with six wraps. A molle can be used as a temporary method of connecting the eye splices of two lines. A molle is used in most pin shackles in place of a cotter key.

Must. The same as "shall" and is mandatory.

New job site. A location of operations when the loading station and/or the yarder or cutting operations are moved to a new area outside of the current sale or contracted unit.

Pass line. A small line threaded through a block at the top of the spar to assist the high climber.

Permissible (as applied to any device, equipment or appliance). Such device, equipment, or appliance has the formal approval of the United States Bureau of Mines, American Standards Association, or National Board of Fire Underwriters.

Portable spar or tower. A movable engineered structure designed to be used in a manner similar to which a wood spar tree would be used.

Qualified person. A person, who by possession of a recognized degree, certificate, professional standing, or by extensive knowledge, training, and experience, has successfully demonstrated ability to solve or resolve problems relating to the subject matter, the work, or the project.

Rated capacity. The maximum load a system, vehicle, machine or piece of equipment was designed by the manufacturer to handle.

Reach. A steel tube or wood timber or pole connected to the truck and inserted through a tunnel on the trailer. It steers the trailer when loaded and pulls the trailer when empty.

Reload. An area where logs are dumped and reloaded or transferred as a unit to another mode of transportation.

Rollway. Any place where logs are dumped and they roll or slide to their resting place.

Root wad. The ball of a tree root and dirt that is pulled from the ground when a tree is uprooted.

R.O.P.S. Roll over protection structure.

Rub tree. A tree used to guide a turn around an area.

Running line/running rope. Any moving line directly involved with the yarding of logs.

Safety factor. The ratio of breaking strength to a safe working strength or loading.

Safety glass. A type of glass that will not shatter when broken.

Sail block. A block hung inverted on the sail guy to hold the tong block in proper position.

Scaler. The person who measures the diameter and length of the logs, determines specie and grade, and makes deductions for footage calculations.

Serviceable condition. A state or ability of a tool, machine, vehicle or other device to operate as it was intended by the manufacturer to operate.

Shall. A requirement that is mandatory.

Shear log. A log placed in a strategic location to divert passage of objects.

Shore skids. Any group of timbers spaced a short distance apart on which logs are rolled.

Should. Means recommended.

Signal person. The person designated to give signals to the machine operator.

Skidder. A machine or animal used to move logs or trees to a landing.

Skidding. Movement of logs or trees on the surface of the ground to the place where they are to be loaded.

Skidding line. The main haulage line from a carriage to which chokers are attached. Sometimes referred to a mainline.

Skyline. The line suspended between two points on which a block or carriage travels.

Slackline. A form of skyline where the skyline cable is spooled on a donkey drum and can be raised or lowered.

Slack puller. Any weight or mechanical device used to increase the movement of a line when its own weight is inadequate.

Slope (grade). The increase or decrease in altitude over a horizontal distance expressed as a percentage. For example, change of altitude of 20 feet (6 m) over a horizontal distance of 100 feet (30 m) is expressed as a 20 percent slope.

Snag. A dead standing tree or a portion thereof. (See Danger tree)

Snorkel. A loading boom modified to extend its limitations for yarding.

Spar/spar tree. A tree or device (rigged for highlead, skyline or slackline yarding) used to yard logs by any method of logging.

Spike. A long heavy nail similar to a railroad spike.

Springboard. A board with an iron tip used by fallers to stand on while working above ground level.

Spring pole. A tree, segment of a tree, limb, or sapling which is under stress or tension due to the pressure or weight of another object.

Spurious response attenuation. A measure of the receiver's ability to discriminate between a desired signal to which it is resonant and an undesired signal at any other frequency to which it is also responsive.

Square lead. The angle of 90 degrees.

Standing line.

(a) Guyline.

(b) A nonoperating rope with end terminations to support a boom or mast.

Stiff boom. Two or more boom sticks wrapped together on which boom persons walk or work.

Strap. Any short piece of line with an eye or "D" in each end.

Strap socket or D. A socket with a closed loop arranged to be attached to the end of a line by the molten zinc, or an equivalent method. It is used in place of a spliced eye.

Strawline. A light cable used in rigging up, or in moving other cables or blocks. The smallest line on the yarder. (Mainline - Haulback line - Strawline.)

Strip. A definite location of timber on which one or more cutting crews work.

Swamping. The falling or cutting of brush around or along a specified place.

Swede connection. A line configuration made by wrapping two choker lines in the same direction around a tree or log connecting the line knobs to opposite line bells.

Swifter. A piece of equipment used to tie the side sticks of a log raft together to keep the raft from spreading.

Swing cut. An intentional dutchman left on one corner of an undercut or a backcut in which the holding wood on one side is cut through in conjunction with an intentional dutchman to achieve a desired lay for the tree being fell.

Tail block. A block used to guide the haulback line at the back corner of the yarding area.

Tail hold. An anchor used for making fast any line or block.

Tail/lift tree. The tree at the opposite end from the head tree on which the skyline or other type rigging is hung.

Tie back. To use a twister(s) (or similar system/device) that has a breaking strength equal to fifty percent of the breaking strength of the mainline or skyline whichever is greater. To secure or support one anchor by securing it to a second anchor(s) such as wrapping one stump and choking another.

Tie down. A chain, cable, steel strips or fiber webbing and binders attached to a truck, trailer or other conveyance as a means to secure loads and to prevent them from shifting or moving when they are being transported.

Tight line. When either the mainline or haulback are held and power is exerted on the other or when power is exerted on both at the same time.

Tong line block. The block hung in a boom through which the tong line operates.

Tongue. A device used to pull and/or steer a trailer.

Topping. Cutting off the top section of a standing tree.

Tower. (See portable spar or tower).

Tractor. A machine of wheel or track design used in logging.

Tractor logging. The use of any wheeled or tracked vehicle in the skidding or yarding of logs.

Transfer (as used in loading). Changing of logs in a unit from one mode of transportation to another.

Tree jack. A grooved saddle of wood or metal rollers contained within two steel plates, attached to a tree with a strap, used as a guide for skyline, sail guy, or similar static line. It is also formed to prevent a sharp bend in the line.

Tree plates. Steel bars sometimes shaped as elongated J's, which are fastened near the top of a tree to hold guylines and prevent them from cutting into the tree when tightened. The hooks of the J are also used to prevent the mainline block strap from sliding down the tree.

Tree pulling. A method of falling trees in which the tree is pulled down with a line.

Tug. A boat, usually over twenty feet in length, used primarily to pull barges, booms of logs, bags of debris, or log rafts.

Turn. Any log or group of logs attached by some means to power and moved from a point of rest to a landing.

Twister. A line (usually small diameter wire rope "haywire") that supports a tailhold stump, guyline stump, or tree that does not appear to be strong enough. This is done by connecting the tailhold to another stump or tree opposite by wrapping the two with a line. This line is then tightened by placing a piece of large-diameter limb between the wrappings and twisting them together.

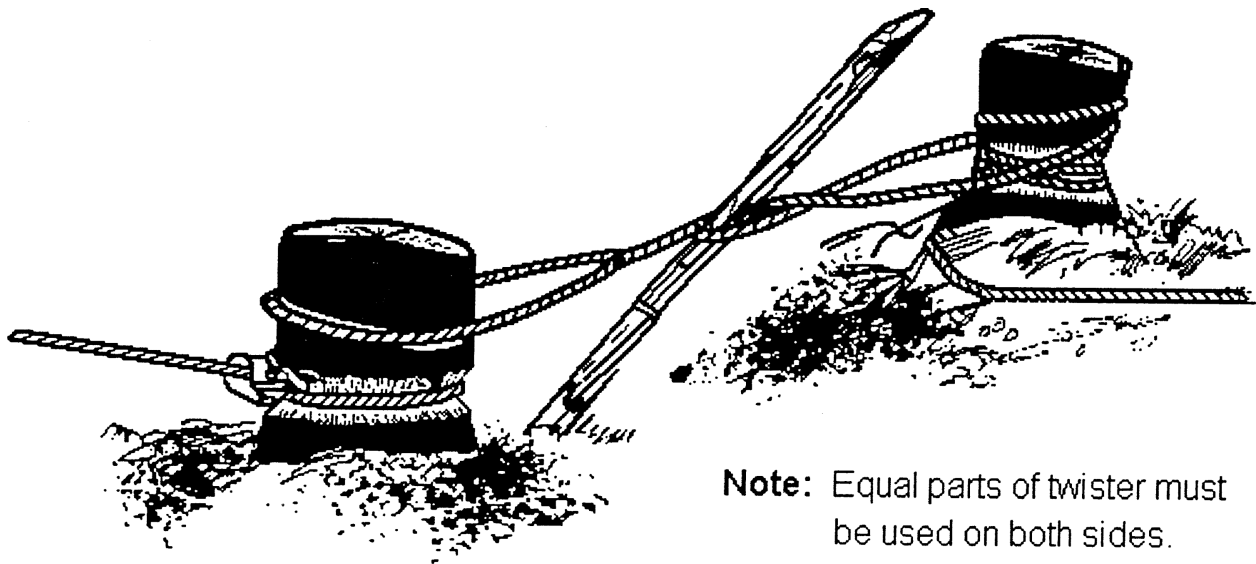

Note: Equal parts of twister must be used on both sides.

TWISTER ROPE

Undercut. A notch cut in a tree to guide the direction of the tree fall and to prevent splitting or kickback.

V-lead. A horizontal angle of less than ninety degrees formed by the projected lines of the mainline from the drum of the logging machine through the block or fairlead and the yarding log or turn.

Vehicle/crew bus. A car, bus, truck, trailer or semi-trailer owned, leased, or rented by the employer that is used for transportation of employees or movement of material.

WAC. Washington Administrative Code.

Waistline. That portion of the haulback running between the corner block and the tail block.

Winching. The winding of cable or rope onto a spool or drum.

Within the stakes. When one-half the log diameter is below the stake top.

Work areas. Any area frequented by employees in the performance of assigned or related duties.

Wrapper. A cable assembly or chain used to contain a load of logs.

Wrapper rack. Barrier used to protect a person while removing binders and wrappers from a loaded logging truck.

Yarder (donkey). A machine with a series of drums used to yard logs.

Yarding. The movement of logs from the place they are felled to a landing.

[Statutory Authority: RCW 49.17.010, 49.17.040, 49.17.050, 49.17.060, and chapter 49.17 RCW. WSR 17-17-131, § 296-54-505, filed 8/22/17, effective 10/22/17. Statutory Authority: RCW 49.17.010, [49.17].040 and [49.17].050. WSR 99-17-117, § 296-54-505, filed 8/18/99, effective 12/1/99. Statutory Authority: RCW 49.17.040, [49.17].050 and [49.17].060. WSR 96-22-013, § 296-54-505, filed 10/28/96, effective 1/1/97. Statutory Authority: Chapter 49.17 RCW. WSR 87-24-051 (Order 87-24), § 296-54-505, filed 11/30/87. Statutory Authority: RCW 49.17.040, 49.17.050, 49.17.240, chapters 43.22 and 42.30 RCW. WSR 80-11-057 (Order 80-15), § 296-54-505, filed 8/20/80. Statutory Authority: RCW 49.17.040, 49.17.150 and 49.17.240. WSR 79-10-081 (Order 79-14), § 296-54-505, filed 9/21/79.]

WAC 296-54-507 Employer's responsibilities. You must comply with the requirements of all safety and health regulations and must:

- (1) Provide safety training for each employee.
- (2) Take additional precautions to ensure safe operations when extreme weather or other extreme conditions create hazards. If the operation cannot be made safe, the work must be discontinued until safe to resume.
- (3) Ensure that danger trees within reach of landings, rigging, buildings, or work areas are either fell before regular operations begin, or arrange work so that employees are not exposed to the related hazards.
- (4) Develop and maintain a hazard communication program as required by WAC 296-901-140. The program must provide information to all employees about hazardous chemicals or substances to which they are exposed, or may become exposed, in the course of their employment.
- (5) Ensure that intoxicating beverages and narcotics are prohibited on or near the worksite. You must remove from the worksite any employee under the influence of alcohol or narcotics.

Note: Narcotics do not include prescription drugs taken under a doctor's direction if the use does not endanger any employee.

[Statutory Authority: RCW 49.17.010, 49.17.040, 49.17.050, 49.17.060, and chapter 49.17 RCW. WSR 17-17-131, § 296-54-507, filed 8/22/17, effective 10/22/17. Statutory Authority: RCW 49.17.010, 49.17.040, 49.17.050, 49.17.060 and 29 C.F.R. 1910 Subpart Z. WSR 14-07-086, § 296-54-507, filed 3/18/14, effective 5/1/14. Statutory Authority: RCW 49.17.010, 49.17.040, 49.17.050, 49.17.060. WSR 06-07-142, § 296-54-507, filed 3/21/06, effective 5/1/06. Statutory Authority: RCW 49.17.010, [49.17].040, and [49.17].050. WSR 01-11-038, § 296-54-507, filed 5/9/01, effective 9/1/01; WSR 99-17-117, § 296-54-507, filed 8/18/99, effective 12/1/99. Statutory Authority: Chapter 49.17 RCW. WSR 94-16-145, § 296-54-507, filed 8/3/94, effective 9/12/94; WSR

89-11-035 (Order 89-03), § 296-54-507, filed 5/15/89, effective 6/30/89. Statutory Authority: RCW 49.17.040, 49.17.050, 49.17.240, chapters 43.22 and 42.30 RCW. WSR 80-11-057 (Order 80-15), § 296-54-507, filed 8/20/80. Statutory Authority: RCW 49.17.040, 49.17.150 and 49.17.240. WSR 79-10-081 (Order 79-14), § 296-54-507, filed 9/21/79.]

WAC 296-54-509 Employee's responsibility. (1) Employees must coordinate and cooperate with you and other employees in an attempt to eliminate accidents.

(2) Employees must be aware of and follow all safe practices that apply to their work.

(3) Employees should offer safety suggestions that may contribute to a safer work environment.

(4) Intoxicating beverages and narcotics must not be permitted or used by employees in or around the worksites. Employees under the influence of alcohol or narcotics must not be permitted on the worksite.

EXCEPTION: This rule does not apply to employees taking prescription drugs and/or narcotics as directed by a physician if the use does not endanger the employee or others.

(5) Employees must conduct themselves in a workmanlike manner while on the worksite.

(6) Employees must make prompt report to their immediate supervisor of each industrial injury or occupational illness, regardless of the degree of severity.

[Statutory Authority: RCW 49.17.010, 49.17.040, 49.17.050, 49.17.060, and chapter 49.17 RCW. WSR 17-17-131, § 296-54-509, filed 8/22/17, effective 10/22/17. Statutory Authority: RCW 49.17.010, [49.17].040 and [49.17].050. WSR 99-17-117, § 296-54-509, filed 8/18/99, effective 12/1/99. Statutory Authority: RCW 49.17.040, 49.17.150 and 49.17.240. WSR 79-10-081 (Order 79-14), § 296-54-509, filed 9/21/79.]

WAC 296-54-511 Personal protective equipment (PPE). (1) Protective equipment, including personal protective equipment for eyes, face, head, hearing and extremities, protective clothing, respiratory devices and protective shields and barriers, must be used, and maintained in a sanitary and reliable condition wherever it is necessary by reason of hazards of processes or environment, chemical hazards, radiological hazards, or mechanical irritants encountered in a manner capable of causing injury or impairment in the function of any part of the body through absorption, inhalation or physical contact.

(2) Personal protective equipment, including any personal protective equipment provided by an employee, must be maintained in a serviceable condition.

(3) All personal protective equipment must be of safe design and construction for the work to be performed.

(4) Personal protective equipment, including any personal protective equipment provided by an employee, must be inspected before initial use during each workshift. Defects or damage must be repaired or the unserviceable personal protective equipment must be replaced before work is commenced.

(5) Personal protective equipment required by this standard must be provided at no cost to the employee.

Note: The employer is not required to provide logging boots for employees. The cost of logging boots may be borne by employees. The employer must ensure, however, that logging boots as well as all PPE provided by the employer, are worn by employees and are in serviceable condition and meet the requirements in subsection (5) of this section.

[Statutory Authority: RCW 49.17.010, 49.17.040, 49.17.050, 49.17.060, and chapter 49.17 RCW. WSR 17-17-131, § 296-54-511, filed 8/22/17, effective 10/22/17. Statutory Authority: RCW 49.17.010, 49.17.040, 49.17.050, 49.17.060. WSR 09-05-071, § 296-54-511, filed 2/17/09, effective 4/1/09. Statutory Authority: RCW 49.17.010, [49.17].040 and [49.17].050. WSR 99-17-117, § 296-54-511, filed 8/18/99, effective 12/1/99. Statutory Authority: RCW 49.17.040, [49.17].050 and [49.17].060. WSR 96-22-013, § 296-54-511, filed 10/28/96, effective 1/1/97. Statutory Authority: Chapter 49.17 RCW. WSR 94-20-057 (Order 94-16), § 296-54-511, filed 9/30/94, effective 11/20/94. Statutory Authority: RCW 49.17.040 and 49.17.050. WSR 83-24-013 (Order 83-34), § 296-54-511, filed 11/30/83. Statutory Authority: RCW 49.17.040, 49.17.050, 49.17.240, chapters 43.22 and 42.30 RCW. WSR 80-11-057 (Order 80-15), § 296-54-511, filed 8/20/80. Statutory Authority: RCW 49.17.040, 49.17.150 and 49.17.240. WSR 79-10-081 (Order 79-14), § 296-54-511, filed 9/21/79.]

WAC 296-54-51110 Head protection. You must provide, at no cost to the employee, and ensure that all employees wear a hard hat whenever there is a potential exposure to danger of flying or falling objects, unless the employees are protected by FOPS, cabs, or canopies meeting the requirements of this chapter.

(1) Head protection (hard hats) must comply with any of the following consensus standards:

(a) ANSI Z89.1-2009, "American National Standard for Industrial Head Protection";

(b) ANSI Z89.1-2003, "American National Standard for Industrial Head Protection"; or

(c) ANSI Z89.1-1997, "American National Standard for Personnel Protection - Protective Headwear for Industrial Workers - Requirements."

Note: You may use protective helmets that do not meet these ANSI standards if you can demonstrate that they are equally effective as those constructed in accordance with the above ANSI standards.

(2) Hard hats must be maintained in serviceable condition.

[Statutory Authority: RCW 49.17.010, 49.17.040, 49.17.050, 49.17.060, and chapter 49.17 RCW. WSR 17-17-131, § 296-54-51110, filed 8/22/17, effective 10/22/17. Statutory Authority: RCW 49.17.010, [49.17].040 and [49.17].050. WSR 99-17-117, § 296-54-51110, filed 8/18/99, effective 12/1/99.]

WAC 296-54-51120 Eye and face protection. You must provide, at no cost to the employee, and ensure that each employee wears:

(1) Eye protection meeting the requirements of WAC 296-800-160, where there is potential for eye injury from falling or flying objects; and

(2) Face protection meeting the requirements of WAC 296-800-160, where there is potential for facial injury such as, but not limited to, operating a chipper. An employee using a chain saw may use either eye or face protection.

Note: The employee does not have to wear separate eye protection when the face protection also covers the eyes.

Note: Mesh type screen goggles or face shields, which conform to ANSI Z87.1, may be used while operating a chain saw or during chipping operations.

[Statutory Authority: RCW 49.17.010, 49.17.040, 49.17.050, 49.17.060, and chapter 49.17 RCW. WSR 17-17-131, § 296-54-51120, filed 8/22/17, effective 10/22/17. Statutory Authority: RCW 49.17.010, [49.17].040, and [49.17].050. WSR 01-11-038, § 296-54-51120, filed 5/9/01, effective 9/1/01; WSR 99-17-117, § 296-54-51120, filed 8/18/99, effective 12/1/99.]

WAC 296-54-51130 Hearing protection. You must provide hearing protection when required by chapter 296-817 WAC, Hearing loss prevention (noise).

[Statutory Authority: RCW 49.17.010, 49.17.040, 49.17.050, 49.17.060, and chapter 49.17 RCW. WSR 17-17-131, § 296-54-51130, filed 8/22/17, effective 10/22/17. Statutory Authority: RCW 49.17.010, 49.17.040, 49.17.050, and 49.17.060. WSR 03-11-060, § 296-54-51130, filed 5/19/03, effective 8/1/03. Statutory Authority: RCW 49.17.010, [49.17].040 and [49.17].050. WSR 99-17-117, § 296-54-51130, filed 8/18/99, effective 12/1/99.]

WAC 296-54-51140 Hand protection. (1) You must provide, and make sure that each employee handling wire rope or other rough materials uses hand protection that provides adequate protection from puncture wounds, cuts, and lacerations.

(2) Hand protection must be maintained in serviceable condition.

[Statutory Authority: RCW 49.17.010, 49.17.040, 49.17.050, 49.17.060, and chapter 49.17 RCW. WSR 17-17-131, § 296-54-51140, filed 8/22/17, effective 10/22/17. Statutory Authority: RCW 49.17.010, 49.17.040, 49.17.050, 49.17.060. WSR 06-07-142, § 296-54-51140, filed 3/21/06, effective 5/1/06. Statutory Authority: RCW 49.17.010, [49.17].040 and [49.17].050. WSR 99-17-117, § 296-54-51140, filed 8/18/99, effective 12/1/99.]

WAC 296-54-51150 Respiratory protection. You must provide respiratory protection when required by chapter 296-842 WAC, Respirators.

[Statutory Authority: RCW 49.17.010, 49.17.040, 49.17.050, 49.17.060, and chapter 49.17 RCW. WSR 17-17-131, § 296-54-51150, filed 8/22/17, effective 10/22/17. Statutory Authority: RCW 49.17.010, 49.17.040, 49.17.050, 49.17.060. WSR 05-20-055, § 296-54-51150, filed 10/3/05, effective 12/1/05; WSR 05-03-093, § 296-54-51150, filed 1/18/05, effective 3/1/05. Statutory Authority: RCW 49.17.010, [49.17].040 and [49.17].050. WSR 99-17-117, § 296-54-51150, filed 8/18/99, effective 12/1/99.]

WAC 296-54-51160 Leg protection. (1) You must provide, at no cost to the employee, and ensure that each employee who operates a chain saw wears leg protection meeting the requirements of ASTM F1897-1998 "American Society for Testing and Materials Standard Specification for Leg Protection for Chain Saw Users." The leg protection

must cover the full length of the thigh to the top of the boot on each leg to protect against contact with a moving chain saw.

Note: You may use leg protection that meets newer versions of the ASTM standard.

EXCEPTION: This requirement does not apply to an employee working aloft in trees when supported by climbing spurs and climbing belt, or when an employee is working from a vehicle-mounted elevating and rotating work platform meeting the requirements of chapter 296-869 WAC, Elevating work platforms.

(2) Leg protection must be maintained in serviceable condition.

[Statutory Authority: RCW 49.17.010, 49.17.040, 49.17.050, 49.17.060, and chapter 49.17 RCW. WSR 17-17-131, § 296-54-51160, filed 8/22/17, effective 10/22/17. Statutory Authority: RCW 49.17.010, 49.17.040, 49.17.050, 49.17.440, 49.17.060, and 29 C.F.R. 1926, Subpart CC. WSR 12-01-086, § 296-54-51160, filed 12/20/11, effective 2/1/12. Statutory Authority: RCW 49.17.010, [49.17].040, and [49.17].050. WSR 01-11-038, § 296-54-51160, filed 5/9/01, effective 9/1/01; WSR 99-17-117, § 296-54-51160, filed 8/18/99, effective 12/1/99.]

WAC 296-54-51170 Foot protection. (1) Each employee must wear foot protection that covers and supports the ankle, such as heavy-duty boots.

(2) Each employee who operates a chain saw must wear cut resistant foot protection that will protect the employee against contact with a running chain saw.

For example: Leather logging boots, insulated rubber pacs, and rubber boots with cut protection will meet the cut-resistant requirement of this section.

(3) All employees whose duties require them to walk on logs or boomsticks must wear sharp-calked boots, or the equivalent.

EXCEPTION 1: When calks are ineffective because of ice, snow, or other conditions and other footwear does not provide suitable protection, employees must be prohibited from working on logs or boomsticks.

EXCEPTION 2: The employer may allow employees to wear nonslip boots instead of calks when the nonslip boots provide greater employee protection than calks (such as at scaling stations, log sorting yards, etc.). The nonslip boots must still provide firm ankle support and secure footing.

(4) Foot protection must be maintained in serviceable condition.

[Statutory Authority: RCW 49.17.010, 49.17.040, 49.17.050, 49.17.060, and chapter 49.17 RCW. WSR 17-17-131, § 296-54-51170, filed 8/22/17, effective 10/22/17. Statutory Authority: RCW 49.17.010, [49.17].040 and [49.17].050. WSR 99-17-117, § 296-54-51170, filed 8/18/99, effective 12/1/99.]

WAC 296-54-51190 Highly visible clothing. (1) Employees working on landings or in log sorting yards on or from the ground, must wear at least one piece of highly visible equipment, whether it be their hard hat, yellow or orange vests, or other similarly colored garments, to make employees more visible to equipment operators.

Note: The department recommends that hard hats and vests or outer garments be luminous or reflective.

(2) An employee working as a flagger must wear a hard hat and vest or other garment of high visibility colors. Warning vests and hard hats worn at night must be reflective.

[Statutory Authority: RCW 49.17.010, 49.17.040, 49.17.050, 49.17.060, and chapter 49.17 RCW. WSR 17-17-131, § 296-54-51190, filed 8/22/17, effective 10/22/17. Statutory Authority: RCW 49.17.010, [49.17].040 and [49.17].050. WSR 99-17-117, § 296-54-51190, filed 8/18/99, effective 12/1/99.]

WAC 296-54-513 Arrangement of work areas and emergency contact.

(1) Employee work areas must be spaced and employee duties organized so the actions of one employee do not create a hazard for any other employee.

(2) Work areas must be assigned so that:

(a) Trees cannot fall into an adjacent occupied work area;

(b) The distance between work areas is at least two tree lengths of the trees being fell;

(c) The distance between work areas reflects the degree of slope, the density of the growth, the height of the trees, the soil structure and other hazards reasonably anticipated at the worksite; and

(d) A distance of more than two tree lengths is maintained between work areas on any slope where rolling or sliding of trees or logs is reasonably foreseeable.

(3) Each employee must be within visual, audible, or radio/telephone contact with another person who can assist in case of emergency.

(4) In any logging operation where cutting, yarding, or loading are performed, there must be at least two employees working as a team.

(5) Each employee must have visual or audible signal contact with another employee as often as this schedule requires:

(a) Cutters - 30 minutes.

(b) All other employees - 2 hours, which allows for making layouts, notching guyline stumps, etc., during normal work hours.

Exception: The requirements for a two-person team and check-in schedule do not apply to operators of motor vehicles, mechanized logging machines, watchpersons or certain other jobs which, by their nature, are singular employee assignments. However, a procedure for checking the welfare of these employees during their working hours must be instituted and all employees so advised.

(6) Mechanics or other employees must not be assigned to work on equipment by themselves when there is a probability of a fall from elevated work locations or equipment. Also, if the work is of such nature that heavy parts require moving, or there is a probability that anything heavy could fall on the person, there must be another person in the immediate area to render assistance.

(7) You must establish a method of checking the employees in from the woods at the end of each shift, including operators of all movable equipment. Each immediate supervisor must account for their crew.

(8) Each logging worksite must have at least one serviceable and operable two-way radio, phone, or radio/phone combination available to reach emergency service. Citizen band radios are permitted only as a secondary means of communication.

(9) Each logging worksite must have an emergency medical plan to ensure rapid emergency medical care for employees with major illnesses and injuries. The plan must be in writing and include the following:

(a) Township, range, and section numbers or latitude and longitude;

(b) Directions by road, or escort provisions to the site;

(c) Telephone number of emergency medical services; and

(d) Provisions for emergency vehicle(s) access, when working behind locked gate(s).

[Statutory Authority: RCW 49.17.010, 49.17.040, 49.17.050, 49.17.060, and chapter 49.17 RCW. WSR 17-17-131, § 296-54-513, filed 8/22/17, effective 10/22/17. Statutory Authority: RCW 49.17.010, [49.17].040 and [49.17].050. WSR 99-17-117, § 296-54-513, filed 8/18/99, effective 12/1/99. Statutory Authority: RCW 49.17.040, [49.17].050 and [49.17].060. WSR 96-22-013, § 296-54-513, filed 10/28/96, effective 1/1/97. Statutory Authority: RCW 49.17.040, 49.17.150 and 49.17.240. WSR 79-10-081 (Order 79-14), § 296-54-513, filed 9/21/79.]

WAC 296-54-515 Accident prevention program. (1) You must develop a formal accident prevention program, tailored to the needs of the particular workplace or operation and to the type of hazards involved. The program must be implemented in a manner that is effective in practice.

(2) The accident prevention program must be in writing.

(3) The accident prevention program must cover at least the following elements:

(a) A safety training program that describes the employer's total safety program.

(b) How and when to report injuries;

(c) The location of first-aid supplies;

(d) Safe use, operation and maintenance of tools, machines and vehicles the employee uses or operates;

(e) How to report unsafe conditions and practices;

(f) The use and care of required personal protective equipment;

(g) An on-the-job review of the practices necessary to perform job assignments safely; and

(h) Recognition of safety and health hazards associated with the employee's specific work tasks, including using measures and work practices to prevent or control those hazards.

(4) You must document and maintain current records of required training, including:

(a) Who was trained;

(b) The date(s) of the training; and

(c) The signature of the trainer or yours.

[Statutory Authority: RCW 49.17.010, 49.17.040, 49.17.050, 49.17.060, and chapter 49.17 RCW. WSR 17-17-131, § 296-54-515, filed 8/22/17, effective 10/22/17. Statutory Authority: RCW 49.17.010, 49.17.040, 49.17.050, 49.17.060. WSR 06-07-142, § 296-54-515, filed 3/21/06, effective 5/1/06. Statutory Authority: RCW 49.17.010, [49.17].040 and [49.17].050. WSR 99-17-117, § 296-54-515, filed 8/18/99, effective 12/1/99. Statutory Authority: RCW 49.17.040, [49.17].050 and [49.17].060. WSR 96-22-013, § 296-54-515, filed 10/28/96, effective 1/1/97. Statutory Authority: RCW 49.17.040, 49.17.050, 49.17.240, chapters 43.22 and 42.30 RCW. WSR 80-11-057 (Order 80-15), § 296-54-515, filed 8/20/80. Statutory Authority: RCW 49.17.040, 49.17.150 and 49.17.240. WSR 79-10-081 (Order 79-14), § 296-54-515, filed 9/21/79.]

WAC 296-54-51510 Safety and health meetings. (1) You must hold safety and health meetings at least monthly.

(2) A safety and health meeting must be held each time you move logging or timber felling operations to a new job site.

Note: When moving to a new job site, site specific hazards should be identified and discussed during the prejob safety meeting.

(3) Safety and health meetings may be conducted individually, in crew meetings, in larger groups, or as part of other staff meetings.

(4) Attendance and subject(s) must be documented.

[Statutory Authority: RCW 49.17.010, 49.17.040, 49.17.050, 49.17.060, and chapter 49.17 RCW. WSR 17-17-131, § 296-54-51510, filed 8/22/17, effective 10/22/17. Statutory Authority: RCW 49.17.010, [49.17].040 and [49.17].050. WSR 99-17-117, § 296-54-51510, filed 8/18/99, effective 12/1/99.]

WAC 296-54-51520 First-aid training. (1) At logging worksites, each employee, including supervisors, must hold a valid certificate of first-aid and CPR training. New employees not holding a valid certificate of training must be trained within six months of being hired and they must be working on a crew where at least one person holding a valid certificate of first-aid and CPR training is present at all times.

EXCEPTION: Log truck drivers are not required to receive first-aid and CPR training if they are not involved with falling, yarding, loading, or processing logs.

(2) At road construction and maintenance worksites, whenever two or more employees are present, a person or persons holding a valid certificate of first-aid and CPR training must be present at all times.

(3) At least two persons holding a valid certificate of first-aid training must be present or available at all times in sorting yard operations.

(4) First-aid and CPR training must cover at least the following:

(a) The definition of first aid.

(b) Legal issues of applying first aid (Good Samaritan Laws).

(c) Basic anatomy.

(d) Patient assessment and first aid for the following:

(i) Respiratory arrest.

(ii) Cardiac arrest.

(iii) Hemorrhage.

(iv) Lacerations/abrasions.

(v) Amputations.

(vi) Musculoskeletal injuries.

(vii) Shock.

(viii) Eye injuries.

(ix) Burns.

(x) Loss of consciousness.

(xi) Extreme temperature exposure (hypothermia/hyperthermia).

(xii) Paralysis.

(xiii) Poisoning.

(xiv) Artificial ventilation.

(e) CPR.

(f) Applying dressings and slings.

(g) Treating strains, sprains, and fractures.

(h) Immobilizing injured persons.

(i) Handling and transporting injured persons.

(j) Treating bites, stings, or contact with poisonous plants or animals.

[Statutory Authority: RCW 49.17.010, 49.17.040, 49.17.050, 49.17.060, and chapter 49.17 RCW. WSR 17-17-131, § 296-54-51520, filed 8/22/17, effective 10/22/17. Statutory Authority: RCW 49.17.010, [49.17].040 and [49.17].050. WSR 99-17-117, § 296-54-51520, filed 8/18/99, effective 12/1/99.]

WAC 296-54-51530 First-aid kits. (1) You must provide first-aid kits at all worksites.

(2) Worksite first-aid kits must contain the following minimum supplies at all times:

Note: The contents of the first-aid kit listed should be adequate for small worksites of two or three employees. For larger or multiple logging operations conducted at the same location, the employer should provide additional first-aid kits or additional quantities of supplies in the first-aid kits.

- (a) Gauze pads (at least 4 x 4 inches).
 - (b) Two large gauze pads (at least 8 x 10 inches).
 - (c) Box adhesive bandages (band-aids).
 - (d) One package gauze roller bandage at least 2 inches wide.
 - (e) Two triangular bandages.
 - (f) Wound cleaning agent such as sealed moistened towelettes.
 - (g) Scissors.
 - (h) At least one blanket.
 - (i) Tweezers.
 - (j) Adhesive tape.
 - (k) Latex gloves.
 - (l) Resuscitation equipment such as resuscitation bag, airway, or pocket mask.
 - (m) Two elastic wraps.
 - (n) Splint.
 - (o) One stretcher or equivalent weather proof litter at any three or more person worksite, and at all logging sites.
- (3) Transport vehicles, log trucks, and road graders must have at least the following number and type of first-aid supplies:
- (a) Ten package kit.
 - (b) One pkg. adhesive bandages, 1" (16 per pkg.).
 - (c) One pkg. bandage compress, 4" (1 per pkg.).
 - (d) One pkg. scissors and tweezers (1 each per pkg.).
 - (e) One pkg. triangular bandage, 40" (1 per pkg.).
 - (f) One pkg. antiseptic soap or pads (3 per pkg.).
 - (g) Five pkgs. employer's choice.
- (4) When six or more employees are generally being transported on any one trip, the first-aid kit must be increased in size following the requirements of subsection (2) of this section. Subsection (2)(h), (n) and (o) are optional.
- (5) You must maintain the contents of each first-aid kit in a serviceable condition.

[Statutory Authority: RCW 49.17.010, 49.17.040, 49.17.050, and 49.17.060, and chapter 49.17 RCW. WSR 17-17-131, § 296-54-51530, filed 8/22/17, effective 10/22/17. Statutory Authority: RCW 49.17.010, [49.17].040 and [49.17].050. WSR 99-17-117, § 296-54-51530, filed 8/18/99, effective 12/1/99.]

- WAC 296-54-517 Lockout/tagout procedures.** (1) You must establish and implement written procedures for lockout/tagout to prevent the accidental start up or release of stored energy of machinery that is shut down for repairs, maintenance, or adjustments.
- (2) Lockout/tagout procedures must contain specific steps for:
- (a) Shutting down, blocking, and securing machines to control hazardous energy;
 - (b) Locking and/or tagging out machinery; and
 - (c) Release from lockout/tagout.
- (3) Lockout/tagout procedure details must include at least the following:
- (a) Employees performing maintenance, repairs, or adjustments have knowledge of the hazardous energy to be controlled and the means to control the energy.
 - (b) Machine shutdown.
 - (c) Apply brakes, swing locks, etc.

(d) Place the transmission in the manufacturer's specified park position.

(e) Lower to the ground or secure each moving element such as, but not limited to, blades, booms, grapples, buckets, saws, and shears to prevent a release of stored energy.

(f) Shut down machinery and ensure that a responsible person removes and maintains possession of the ignition/master key.

(g) Engage hydraulic safety locks when applicable.

(h) Before working on hydraulic or air systems, relieve pressure by bleeding tanks or lines and operate controls to dissipate residual stored energy (pressure).

(i) Place lockout and/or tagout device.

(4) Before lockout or tagout devices are removed and machinery is started, the work area must be inspected to ensure that all tools have been removed, guards are replaced, and employees are in the clear.

(5) You must provide padlocks and/or tags for locking and/or tagging out machinery that are durable enough to withstand the environment.

(6) Tags must have a legend such as "do not start" or "do not operate." Tags must be placed so they are obvious to anyone attempting to operate the machinery.

Note: In lockout, padlocks are commonly used to prevent access to ignition/master switches or battery disconnects.

(7) Stored or residual energy such as that in elevated machine members, rotating saws, hydraulic systems, air pressure and springs, must be dissipated or restrained by methods such as grounding, repositioning, blocking, chaining, bleeding down, etc.

(8) You must provide training to ensure that the purpose and function of the lockout/tagout program are understood by employees performing maintenance, repairs, or adjustments covered by this section. This program must be reviewed at least annually and training provided as needed. This training may be accomplished through safety meetings.

Note: See appendix 2 for a sample lockout/tagout program (energy control program).

[Statutory Authority: RCW 49.17.010, 49.17.040, 49.17.050, 49.17.060, and chapter 49.17 RCW. WSR 17-17-131, § 296-54-517, filed 8/22/17, effective 10/22/17. Statutory Authority: RCW 49.17.010, [49.17].040 and [49.17].050. WSR 99-17-117, § 296-54-517, filed 8/18/99, effective 12/1/99. Statutory Authority: RCW 49.17.040, 49.17.050, 49.17.240, chapters 43.22 and 42.30 RCW. WSR 80-11-057 (Order 80-15), § 296-54-517, filed 8/20/80. Statutory Authority: RCW 49.17.040, 49.17.150 and 49.17.240. WSR 79-10-081 (Order 79-14), § 296-54-517, filed 9/21/79.]

WAC 296-54-519 Miscellaneous requirements. (1) Spikes, drift bolts, nails, or other metal must not be left in any recoverable log.

(2) You must provide and maintain portable fire extinguishers on each machine and vehicle.

(3) Machines, vehicles, and portable powered tools (unless diesel powered) must not be fueled while the motors are running.

Note: See WAC 296-54-58130(3) for exceptions related to helicopters.

(4) Flammable liquids must be stored, handled, transported, and used according to the requirements of chapter 296-24 WAC, Part E, and the following:

(a) Flammable liquids must not be transported in the driver compartment or in any passenger-occupied area of a machine or vehicle.

(b) Flammable liquids, including chain-saw and diesel fuel, may be used to start a fire, if the employer ensures that in the particular situation its use does not create a hazard for an employee.

(5) Smoking is prohibited in battery charging areas and within fifty feet of all refueling operations. Precautions must be taken to prevent open flames, sparks, or electric arcs in battery charging or refueling areas.

(6) When charging batteries:

(a) The vent caps must be kept in place to avoid electrolyte spray;

(b) Caps must be functioning; and

(c) The battery (or compartment) cover(s) must be open to dissipate heat.

(7) Tools and other metallic objects must be kept away from the tops of uncovered batteries.

(8) Explosives and blasting agents must be stored, handled, transported, and used according to the requirements of chapter 296-52 WAC, Possession and handling of explosives.

[Statutory Authority: RCW 49.17.010, 49.17.040, 49.17.050, 49.17.060, and chapter 49.17 RCW. WSR 17-17-131, § 296-54-519, filed 8/22/17, effective 10/22/17. Statutory Authority: RCW 49.17.010, 49.17.040, 49.17.050, 49.17.060 and 29 C.F.R. 1910 Subpart Z. WSR 14-07-086, § 296-54-519, filed 3/18/14, effective 5/1/14. Statutory Authority: RCW 49.17.010, [49.17].040 and [49.17].050. WSR 99-17-117, § 296-54-519, filed 8/18/99, effective 12/1/99. Statutory Authority: RCW 49.17.040, [49.17].050 and [49.17].060. WSR 96-22-013, § 296-54-519, filed 10/28/96, effective 1/1/97. Statutory Authority: RCW 49.17.040, 49.17.050, 49.17.240, chapters 43.22 and 42.30 RCW. WSR 80-11-057 (Order 80-15), § 296-54-519, filed 8/20/80. Statutory Authority: RCW 49.17.040, 49.17.150 and 49.17.240. WSR 79-10-081 (Order 79-14), § 296-54-519, filed 9/21/79.]

WAC 296-54-520 Chain shot awareness and prevention. "Chain shot" is the high velocity separation and ejection of a piece or pieces of cutting chain from the end of a broken chain in mechanized timber harvesting. Chain shot exposes both machine operators and bystanders to a risk of serious injury or death. Chain shot typically occurs near the drive end of the cutting system but can also come from the bar tip area.

A chain shot consists of two breaks in a chain. First, the loop of the chain breaks and forms two ends. One end moves past the drive sprocket or bar tip and is rapidly accelerated due to a whip-like motion of the chain end. The whip action causes the second break, releasing small parts at extremely high speed.

[Statutory Authority: RCW 49.17.010, 49.17.040, 49.17.050, 49.17.060, and chapter 49.17 RCW. WSR 17-17-131, § 296-54-520, filed 8/22/17, effective 10/22/17.]

WAC 296-54-52001 Chain shot awareness and prevention training.

(1) Employees who will be working on or around any kind of machinery equipped with a hydraulic driven bar and chain are to receive chain

shot awareness training appropriate to their job. This training must include:

(a) Clearance distances for workers around the machine. All bystanders and nonessential personnel should stay clear of the shot cone. Chain shot can travel in excess of 250 feet from the saw. See Illustration 1 for an explanation of the impact area for chain shot awareness.

(b) Personnel expected to maintain chains are to be trained in the proper repair, assembly, inspection, and sharpening as specified by the chain manufacturer.

(2) Operators are to be trained specifically on:

(a) When possible, position the saw bar so the chain shot cone is directed away from the operator and other personnel.

(b) How to properly inspect the cutting system and report any problems.

Note: See WAC 296-54-99015 Appendix 6 – Sample chain shot training program.

Illustration 1: Shot Cone Zone

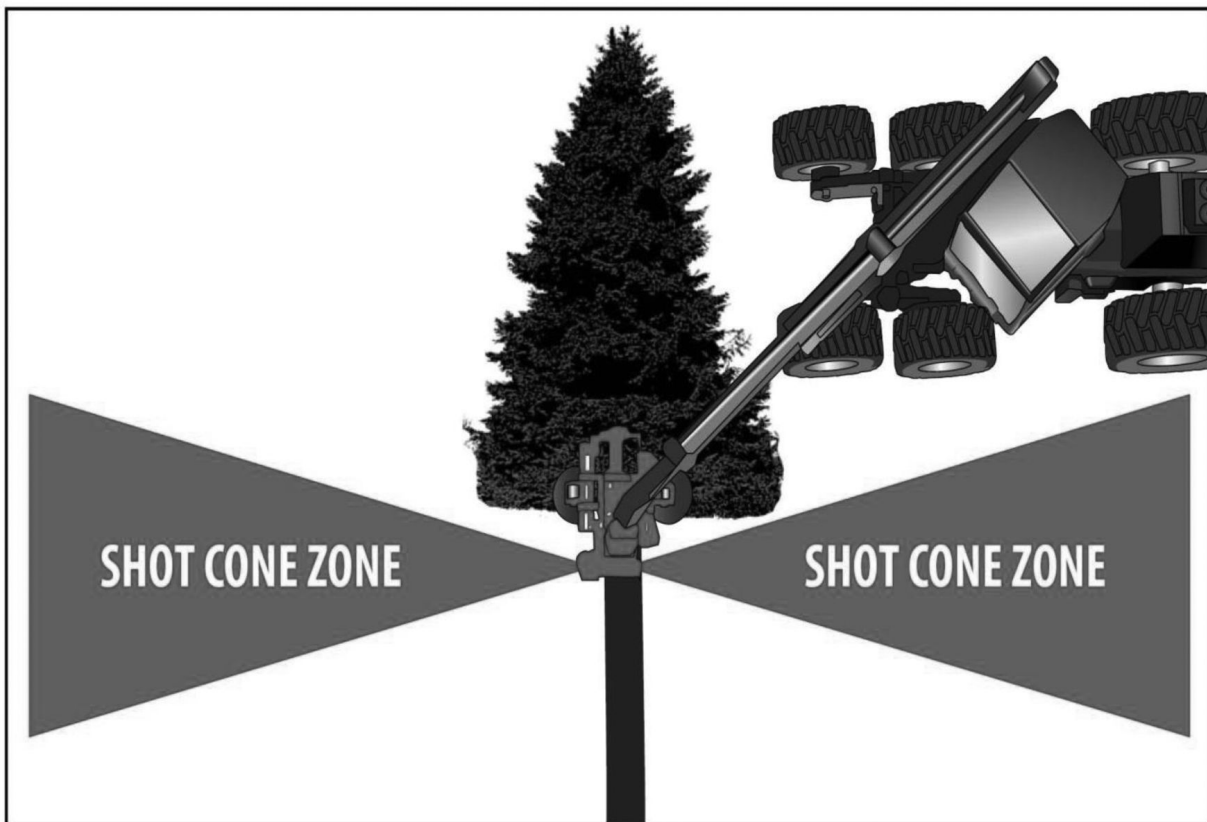

[Statutory Authority: RCW 49.17.010, 49.17.040, 49.17.050, 49.17.060, and chapter 49.17 RCW. WSR 17-17-131, § 296-54-52001, filed 8/22/17, effective 10/22/17.]

WAC 296-54-52003 Cutting system inspection. (1) The cutting system must be inspected before initial use during each workshift. Inspections must include:

(a) The lubrication system for leaks or damage.

(b) The chain for cracks or worn/damaged parts.

- (c) The bar for wear and straightness and ensure the tip is properly secured.
- (d) Sprocket.
- (e) Chain catcher if equipped; and
- (f) Chain shot guard if equipped.
- (2) You must repair defects or damage or the unserviceable machine must be replaced before beginning work.

[Statutory Authority: RCW 49.17.010, 49.17.040, 49.17.050, 49.17.060, and chapter 49.17 RCW. WSR 17-17-131, § 296-54-52003, filed 8/22/17, effective 10/22/17.]

WAC 296-54-52005 Cutting system maintenance. (1) Sharpen chains to the manufacturer's specifications.

- (2) Maintain proper bar and chain lubrication, making sure to use the right type and amount of lubricant.
- (3) Replace the drive sprocket when it has excessive wear.
- (4) Clean guide bar grooves and oil port holes regularly.
- (5) To keep wear even the bar should be flipped regularly.

[Statutory Authority: RCW 49.17.010, 49.17.040, 49.17.050, 49.17.060, and chapter 49.17 RCW. WSR 17-17-131, § 296-54-52005, filed 8/22/17, effective 10/22/17.]

WAC 296-54-52007 Cutting system operation. (1) When possible, keep the chain shot cone clear of the operator and other persons.

- (2) Follow the chain manufacturer's recommendation for chain speed. "Boosting" or exceeding the manufacturer's recommendation is prohibited.
- (3) Maintain proper chain tension.

[Statutory Authority: RCW 49.17.010, 49.17.040, 49.17.050, 49.17.060, and chapter 49.17 RCW. WSR 17-17-131, § 296-54-52007, filed 8/22/17, effective 10/22/17.]

WAC 296-54-521 Motor vehicles. (1) The seats of each vehicle must be securely fastened.

(2) Each school bus type vehicle that will transport nine or more passengers must have a substantial barricade behind the driver. The barricade must extend from the floor to at least a level even with the top of the driver's head.

(3) Adequate provisions must be made for safe entrances and exits. Each vehicle must have mounting steps and handholds wherever it is necessary to prevent an employee injury when entering or leaving the vehicle.

(4) When equipment or tools are carried inside the vehicle, you must provide and use racks, boxes, holsters or other means to transport tools so that a hazard is not created for any vehicle operator or passenger.

(5) No one may enter or exit any vehicle until the vehicle is completely stopped.

(6) Employees must keep all parts of the body within the vehicle.

(7) Heat and light must be available in the passenger area of the vehicle. Use of stoves in vehicles is prohibited.

(8) Vehicles designed to transport nine or more passengers must have an emergency exit that:

(a) Is at least six and one-half square feet in area, with the smallest dimension being at least eighteen inches;

(b) Is placed at the back of the vehicle or near the back on the side opposite the regular entrance; and

(c) Has an unobstructed route to and from the exit.

(9) When no fuel is transported in the crew vehicle, a minimum rated 5/BC dry chemical fire extinguisher must be kept in the passenger compartment. When fuel is transported on the crew vehicle according to subsection (12) of this section, a minimum rated 10/BC dry chemical fire extinguisher must be kept in the passenger compartment. The extinguishing agent must be nontoxic and preferably noncorrosive.

Note: For additional requirements relating to portable fire extinguishers see WAC 296-800-300.

(10) Exhaust systems must be designed and maintained to eliminate the exposure of passengers to toxic agents.

(11) Operating and maintenance instructions must be available in each vehicle. Each vehicle operator and maintenance employee must comply with the operating and maintenance instructions.

(12) Fuel must be transported or stored only in approved safety containers. Enclosed areas where fuels are carried or stored must be vented so that a hazardous concentration of fumes cannot accumulate. All containers or drums must be properly secured to the vehicle while being transported. Commercially built pick-up or flatbed trucks with a maximum seating capacity of six persons may be used to carry fuel in or on the bed of such vehicles, if the fuel is not carried in the crew compartment. Van-type vehicles may be used to carry fuel only when a vapor-proof bulkhead is installed between the passenger compartment and storage compartment. A maximum of forty-two gallons of gasoline may be carried or stored in the compartment and each container must have a maximum capacity seven gallons.

(13) Motor vehicles used regularly to transport employees must be covered against the weather and equipped and operated according to applicable state of Washington motor vehicle laws.

(14) All operators of crew vehicles must be experienced drivers and have a valid operator's license for the class of vehicle being operated.

(15) Dump trucks must only be used in an emergency to transport workers and have adequate safety chains or locking devices that eliminate the possibility of the body of the truck being raised while employees are riding in the truck. "**Emergency**" means any unforeseen circumstances that call for immediate action when danger to life or danger from fire exists.

(16) An effective means of signaling must be provided for communication between the driver and the passengers being transported when they are in separate compartments.

(17) The passenger load limit of a crew vehicle must not exceed the seating capacity of the vehicle.

[Statutory Authority: RCW 49.17.010, 49.17.040, 49.17.050, 49.17.060, and chapter 49.17 RCW. WSR 17-17-131, § 296-54-521, filed 8/22/17, effective 10/22/17. Statutory Authority: RCW 49.17.010, [49.17].040, and [49.17].050. WSR 01-17-033, § 296-54-521, filed 8/8/01, effective 9/1/01; WSR 99-17-117, amended and recodified as § 296-54-521, filed 8/18/99, effective 12/1/99. Statutory Authority: RCW 49.17.040, [49.17].050 and [49.17].060. WSR 96-22-013, § 296-54-531, filed

10/28/96, effective 1/1/97. Statutory Authority: RCW 49.17.040, 49.17.050, 49.17.240, chapters 43.22 and 42.30 RCW. WSR 80-11-057 (Order 80-15), § 296-54-531, filed 8/20/80. Statutory Authority: RCW 49.17.040, 49.17.150 and 49.17.240. WSR 79-10-081 (Order 79-14), § 296-54-531, filed 9/21/79.]

WAC 296-54-523 Inspection and repair of equipment and vehicles.

(1) Defective equipment in need of repair must be reported to management as soon as possible and such equipment must not be used until repairs are completed if there is a possible hazard to safety of the operator or other employees.

(2) Each vehicle used to perform any logging operation must be inspected before initial use during each workshift. Defects or damage must be repaired or the unserviceable vehicle must be replaced before work is commenced.

(3) Each vehicle, machine and piece of equipment used to perform any logging operation must be maintained in serviceable condition.

[Statutory Authority: RCW 49.17.010, 49.17.040, 49.17.050, 49.17.060, and chapter 49.17 RCW. WSR 17-17-131, § 296-54-523, filed 8/22/17, effective 10/22/17. Statutory Authority: RCW 49.17.010, [49.17].040 and [49.17].050. WSR 99-17-117, amended and recodified as § 296-54-523, filed 8/18/99, effective 12/1/99. Statutory Authority: RCW 49.17.040, [49.17].050 and [49.17].060. WSR 96-22-013, § 296-54-521, filed 10/28/96, effective 1/1/97. Statutory Authority: RCW 49.17.040, 49.17.150 and 49.17.240. WSR 79-10-081 (Order 79-14), § 296-54-521, filed 9/21/79.]

WAC 296-54-527 Seat belts. Each machine equipped with ROPS or FOPS and each vehicle (whether provided by the employee or you) must meet the following requirements:

(1) A seat belt must be provided for each vehicle, vehicle occupant, and all machines equipped with ROPS.

Note: An employer is not required to retrofit a vehicle that was not equipped with seat belts at the time of manufacture.

(2) Each employee must use the available seat belt while the vehicle or machine is being operated.

(3) Each employee must securely and tightly fasten the seat belt to restrain the employee within the vehicle or machine cab.

(4) Each machine seat belt must meet the requirements of the Society of Automotive Engineers Standard SAE J386, June 1985, "Operator Restraint Systems for Off-Road Work Machines." Seat belts need not be provided for equipment that is designed **only** for stand-up operations.

(5) Seat belts must not be removed from any vehicle or machine. You must replace each seat belt that was removed from any vehicle or machine that was equipped with seat belts at the time of manufacture.

(6) Each seat belt must be maintained in a serviceable condition.

[Statutory Authority: RCW 49.17.010, 49.17.040, 49.17.050, 49.17.060, and chapter 49.17 RCW. WSR 17-17-131, § 296-54-527, filed 8/22/17, effective 10/22/17. Statutory Authority: RCW 49.17.010, 49.17.040, 49.17.050, 49.17.060. WSR 06-07-142, § 296-54-527, filed 3/21/06, effective 5/1/06. Statutory Authority: RCW 49.17.010, [49.17].040 and [49.17].050. WSR 99-17-117, amended and recodified as § 296-54-527, filed 8/18/99, effective 12/1/99. Statutory Authority: RCW 49.17.040,

[49.17].050 and [49.17].060. WSR 96-22-013, § 296-54-529, filed 10/28/96, effective 1/1/97. Statutory Authority: RCW 49.17.040, 49.17.050, 49.17.240, chapters 43.22 and 42.30 RCW. WSR 80-11-057 (Order 80-15), § 296-54-529, filed 8/20/80. Statutory Authority: RCW 49.17.040, 49.17.150 and 49.17.240. WSR 79-10-081 (Order 79-14), § 296-54-529, filed 9/21/79.]

WAC 296-54-529 Overhead electrical lines clearance. One of the following conditions must exist in work areas where equipment or machines are operated near electrical distribution and transmission lines:

- (1) The lines have been deenergized and visibly grounded at the point of work;
- (2) Insulating barriers that are not a part of or an attachment to the equipment or machinery are erected to prevent physical contact with the lines; or
- (3) All of the following requirements are met:

	Line Voltage	Required minimum clearance between lines and any part of equipment or machine
(a)	50 kV or below	ten feet
(b)	over 50 kV	ten feet plus 0.4 inch for each 1 kV over 50 kV, or twice the length of the line insulator, but never less than ten feet
For equipment or machinery in transit with no load and any boom or extended equipment lowered:		
(c)	50 kV or below	four feet
(d)	50-345 kV	ten feet
(e)	345-750 kV	sixteen feet

(4) Someone must be designated to observe proper clearance and to give timely warning for all operations where it is difficult for the operator to see well enough to maintain the clearance.

(5) All overhead wires must be considered energized unless the line owner or the electrical utility authorities ensure that it is not an energized line and has been visibly grounded.

(6) Special precautions must be taken to prevent trees from falling into power lines. You must notify the power company immediately if a felled tree makes contact with any power line. Before falling any tree that appears will hit a power line, the employer must notify the power company. If a tree does contact a power line, all employees must remain clear of the area until the power company ensures that there is no electrical hazard.

[Statutory Authority: RCW 49.17.010, 49.17.040, 49.17.050, 49.17.060, and chapter 49.17 RCW. WSR 17-17-131, § 296-54-529, filed 8/22/17, effective 10/22/17. Statutory Authority: RCW 49.17.010, [49.17].040 and [49.17].050. WSR 99-17-117, amended and recodified as § 296-54-529, filed 8/18/99, effective 12/1/99. Statutory Authority: RCW 49.17.040, 49.17.050, 49.17.240, chapters 43.22 and 42.30 RCW. WSR 80-11-057 (Order 80-15), § 296-54-527, filed 8/20/80. Statutory Authority: RCW 49.17.040, 49.17.150 and 49.17.240. WSR 79-10-081 (Order 79-14), § 296-54-527, filed 9/21/79.]

WAC 296-54-531 Truck roads. (1) Haul road grades must not exceed 20 percent unless:

(a) Special equipment and safety measures are used to accommodate the steep grade; or

(b) The logging equipment or truck is specifically designed and approved by the manufacturer for operation on grades over twenty percent.

(2) Truck road surfaces must meet the following requirements:

(a) Truck roads are wide enough and even to ensure the safe operation of equipment.

(b) Hazards such as broken planking, deep holes, large rocks, logs, etc., that make equipment operation unsafe, must be immediately corrected.

(c) On blind curves, one of the following must be implemented:

(i) Truck roads are wide enough for two trucks to pass;

(ii) A signal system is maintained; or

(iii) Speed is limited so that the vehicle can be stopped in one-half the visible distance.

(3) For all portions of roads under your direct control, you must ensure that:

(a) All danger trees are felled a safe distance back from the roadway;

(b) Rocks that present a hazard are cleared from banks; and

(c) Brush and other materials that obstruct the view at intersections or on sharp curves are cleared.

(4) All bridge structures used in the logging operation must meet the following requirements:

(a) Structures are adequate to support the maximum imposed loads without exceeding the maximum safe working unit stresses;

(b) Bridges have an adequate number of reflectors to clearly define the entrance to the bridge;

(c) Structures are maintained in good condition and repair;

(d) Structures are inspected at least annually by a qualified authorized person; and

(e) A record maintained of each inspection must be available to a representative of the department on request.

(5) Shear rails must be installed on both outside edges of bridges. The shear rails must be securely fastened and made of material able to withstand the impact generated by contact with the wheels of a loaded vehicle. The top of shear rails must be at least fifteen inches above the bridge surface. Bridges in use before 1980 with outside shear rails a minimum of ten inches high or center shear rails at least five inches high are permissible until repairs are needed.

(6) You must implement measures that minimize dust to the degree that visibility is sufficient to allow an operator to safely operate a vehicle. Vehicle operators must travel at a speed consistent with road conditions.

(7) Pneumatic-tired equipment must have fenders as described in the Society of Automotive Engineers Technical Report J321a.

(8) Employee(s) must be assigned to flag on roads or provide other equivalent protection where hazardous conditions are created from logging such as, but not limited to:

(a) Running wire rope lines or rigging across road grades, excluding guylines and standing skylines if lines remain a safe distance above the road to allow a vehicle to pass under; or

(b) The movement of logs, chunks, or debris across or suspended over road grades.

EXCEPTION: Where there is no through traffic, such as on a dead end road or where the property owner's permission or proper authority is granted to close a section of road, warning signs and barricades may be used instead of flagger(s).

[Statutory Authority: RCW 49.17.010, 49.17.040, 49.17.050, 49.17.060, and chapter 49.17 RCW. WSR 17-17-131, § 296-54-531, filed 8/22/17, effective 10/22/17. Statutory Authority: RCW 49.17.010, [49.17].040 and [49.17].050. WSR 99-17-117, amended and recodified as § 296-54-531, filed 8/18/99, effective 12/1/99. Statutory Authority: RCW 49.17.040, 49.17.150 and 49.17.240. WSR 79-10-081 (Order 79-14), § 296-54-533, filed 9/21/79.]

WAC 296-54-533 Road pioneering and earthwork. (1) Banks at the borrow area must be sloped to prevent slides.

(2) Backfill must be firmly compacted.

(3) Roadside banks must be sloped or stabilized to prevent slides.

(4) Overhanging banks, large rocks and debris must be removed or secured.

(5) Where riprap is used, the material and design must ensure containment of material.

(6) Trees or snags that may fall into the road must be fell.

(7) Root wads, logs, and other unstable debris must not be placed against standing timber or otherwise placed so as to create a hazard for timber falling or other logging operations.

[Statutory Authority: RCW 49.17.010, [49.17].040 and [49.17].050. WSR 99-17-117, amended and recodified as § 296-54-533, filed 8/18/99, effective 12/1/99. Statutory Authority: RCW 49.17.040, [49.17].050 and [49.17].060. WSR 96-22-013, § 296-54-535, filed 10/28/96, effective 1/1/97. Statutory Authority: RCW 49.17.040, 49.17.050, 49.17.240, chapters 43.22 and 42.30 RCW. WSR 80-11-057 (Order 80-15), § 296-54-535, filed 8/20/80. Statutory Authority: RCW 49.17.040, 49.17.150 and 49.17.240. WSR 79-10-081 (Order 79-14), § 296-54-535, filed 9/21/79.]

WAC 296-54-535 Hand and portable powered tools. (1) Each hand and portable powered tool, including any tool provided by an employee, must be maintained in serviceable condition.

(2) Each tool, including any tool provided by an employee, must be inspected before initial use during each workshift. The inspection must include at least the following:

(a) Handles and guards, to ensure that they are sound and tight-fitting, (properly shaped, free of splinters and sharp edges, and in place);

(b) Controls, to ensure proper function;

(c) Chain saw chains, to ensure proper adjustment;

(d) Chain saw mufflers, to ensure that they are operational and in place;

(e) Chain brakes and/or nose shielding devices, to ensure that they are in place and function properly;

(f) Heads of shock, impact-driven and driving tools, to ensure that there is no mushrooming.

(3) Each tool must be used and maintained according to the following requirements:

- (a) Each tool is used only for purposes for which it was designed.
- (b) Any shock, impact-driven or driving tool is repaired or removed from service when the head begins to chip.
- (c) The cutting edge of each tool is sharpened according to manufacturer's specifications whenever it becomes dull during the work-shift.
- (d) Each tool is stored in the provided location when not being used at a worksite.

Note: See chapter 296-807 WAC, Portable power tools, for rules on the use and maintenance of tools and other equipment not covered by this chapter.

[Statutory Authority: RCW 49.17.010, 49.17.040, 49.17.050, 49.17.060. WSR 07-03-163, § 296-54-535, filed 1/24/07, effective 4/1/07. Statutory Authority: RCW 49.17.010, [49.17].040 and [49.17].050. WSR 99-17-117, amended and recodified as § 296-54-535, filed 8/18/99, effective 12/1/99. Statutory Authority: RCW 49.17.040, [49.17].050 and [49.17].060. WSR 96-22-013, § 296-54-523, filed 10/28/96, effective 1/1/97. Statutory Authority: RCW 49.17.040, 49.17.150 and 49.17.240. WSR 79-10-081 (Order 79-14), § 296-54-523, filed 9/21/79.]

WAC 296-54-537 Chain saws. (1) Operators must inspect chain saws daily to ensure that handles and guards are in place, and controls and other moving parts are functional.

(a) Each chain saw placed into initial service after February 9, 1995, must be equipped with a chain brake and, shall otherwise meet the requirements of ANSI B175.1-1991 "Safety Requirements for Gasoline-Powered Chain Saws" and the requirements of this chapter;

(b) Each chain saw placed into service before February 9, 1995, must be equipped with a protective device that minimizes chain saw kickback, i.e., reduced kickback bar, chains, bar tip guard, or chain brake;

(c) No chain saw kickback device shall be removed or otherwise disabled; and

(d) Chain saws must be operated and adjusted in accordance with the manufacturer's instructions.

(2) Saw pinching and subsequent chain saw kickback must be prevented by using wedges, levers, guidelines, and saw placement, or by undercutting.

(3) Chain saws must be:

(a) Shutoff while fueling;

(b) Fueled outdoors at least ten feet from anyone smoking or from other potential sources of ignition; and

(c) Started at least 10 feet (3 m) from the fueling area.

(4) Chain saws must have a positive means of stopping the engine.

(5) Unless the carburetor is being adjusted, the chain saw must be shut off before any adjustments or repairs are made to the saw, chain, or bar.

(6) Using a chain saw with a faulty clutch is prohibited.

(7) The bar must be handled only when the chain saw motor is shut off.

(8) The drive end of the chain saw bar must be guarded.

(9) The chain saw must have an automatic throttle control that will return the engine to idle speed when the throttle is released.

Note: Idle speed is when the engine is running and the chain does not rotate on the bar.

(10) The chain saw must be started:

(a) With the chain brake engaged, unless the manufacturer prohibits; or

(b) On the ground, log or where otherwise firmly supported. Drop starting a chain saw is prohibited.

(11) A chain saw must be held with the thumbs and fingers of both hands encircling the handles during operation unless you demonstrate that a greater hazard is posed by keeping both hands on the chain saw in a specific situation.

(12) The chain saw must be carried in a manner that will prevent operator contact with the cutting chain and muffler.

(13) The chain saw must be shut off or at idle before the faller starts to retreat.

(14) The chain saw must be shut down or the chain brake engaged whenever a saw is carried:

(a) Further than 50 feet (15.2 m); or

(b) Less than 50 feet if conditions such as, but not limited to, the terrain, underbrush, and slippery surfaces, may create a hazard for an employee.

(15) A chain saw must not be used to cut directly overhead in a manner where the operator could lose control of the saw, or that would cause limbs, chunks of bark or pieces of wood to fall on the operator.

(16) The chain saw operator must be certain of footing before starting to cut. The chain saw must not be used in a position or at a distance that could cause the operator to become off-balance, to have unsteady footing, or to relinquish a firm grip on the saw.

[Statutory Authority: RCW 49.17.010, 49.17.040, 49.17.050, 49.17.060, and chapter 49.17 RCW. WSR 17-17-131, § 296-54-537, filed 8/22/17, effective 10/22/17. Statutory Authority: RCW 49.17.010, 49.17.040, 49.17.050, 49.17.060. WSR 06-07-142, § 296-54-537, filed 3/21/06, effective 5/1/06. Statutory Authority: RCW 49.17.010, [49.17].040 and [49.17].050. WSR 99-17-117, § 296-54-537, filed 8/18/99, effective 12/1/99. Statutory Authority: RCW 49.17.040, [49.17].050 and [49.17].060. WSR 96-22-013, § 296-54-537, filed 10/28/96, effective 1/1/97. Statutory Authority: RCW 49.17.040, 49.17.150 and 49.17.240. WSR 79-10-081 (Order 79-14), § 296-54-537, filed 9/21/79.]

WAC 296-54-539 Falling and bucking—General. (1) You must assign work areas so that:

(a) Trees cannot fall into an adjacent occupied work area;

(b) The distance between work areas is at least two tree lengths of the trees being fell (see Figure 1: Distance Between Work Areas);

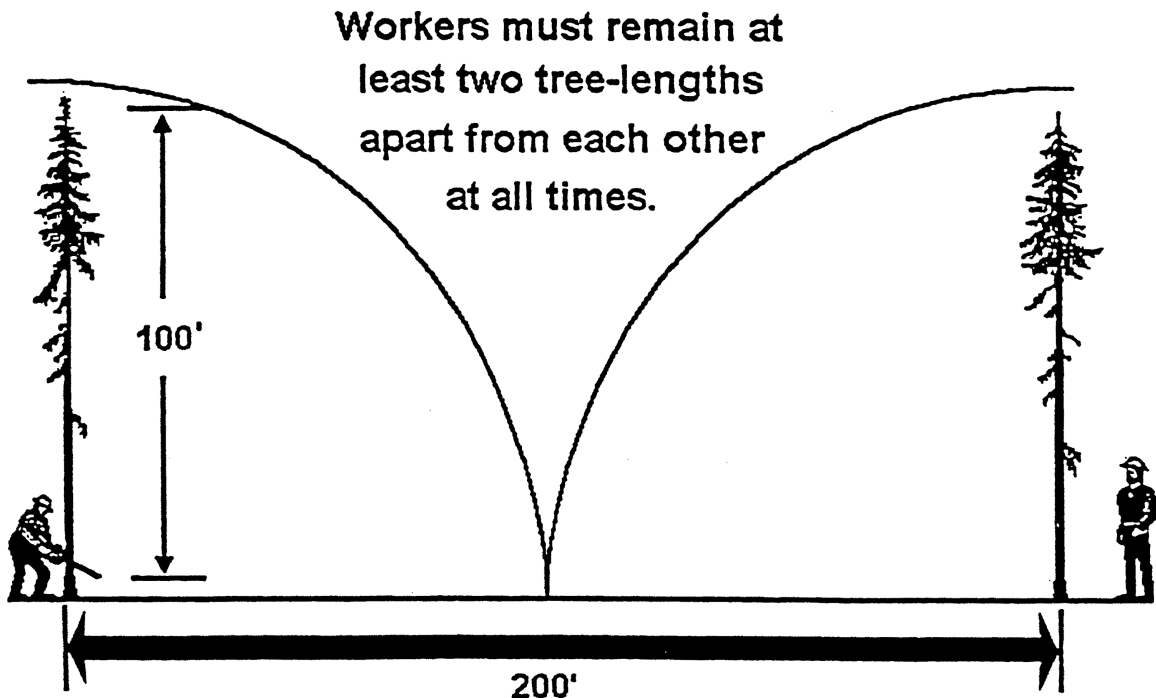

Figure 1: Distance Between Work Area

(c) The distance between work areas reflects the degree of slope, the density of the growth, the height of the trees, the soil structure and other hazards reasonably anticipated at the worksite; and

(d) A distance of more than two tree lengths is maintained between work areas on any slope where rolling or sliding of trees or logs is reasonably foreseeable.

EXCEPTION: This rule does not apply to a team of cutters working on the same tree.

(2) Before falling or bucking, conditions such as, but not limited to, snow and ice accumulation, the wind, the lean of tree, dead limbs, and the location of other trees, must be evaluated by the cutter and precautions taken so a hazard is not created for an employee. Accumulations of snow and ice that may create a hazard for an employee must be removed before beginning falling in the area, or the area must be avoided.

(3) Employees must not approach a cutter closer than two tree lengths of trees being felled until the cutter has acknowledged that it is safe to do so.

(4) A competent person, properly experienced in this type of work, must be placed in charge of falling and bucking operations. Inexperienced workers must not be allowed to fall timber, buck logs or windfalls unless working under the direct supervision of an experienced cutter.

(5) Trees must not be felled if the falling tree can strike any line in the logging operation and endanger workers.

(6) Before an employee falls or bucks any tree:

(a) A sufficient work area must be swamped;

(b) The cutter must plan and clear an escape path; and

(i) The escape path must extend diagonally away from the expected felling line unless such an escape path poses a greater hazard than an alternate escape path; and

(ii) An escape path must be used as soon as the tree or snag is committed to fall, roll, or slide.

(7) If a cutter has determined a tree cannot be safely fell, the work must stop until the cutter has conferred with a supervisor or an experienced cutter and determined the safest possible work method or procedure.

(8) The person in charge of cutting crews must regularly inspect the work of the cutting crews and is responsible to ensure the work is performed in a proper and safe manner.

(9) All cutters must carry or have in near proximity at all times:

- (a) An axe or suitable tool for driving wedges;
- (b) A minimum of two wedges;
- (c) A whistle carried on the person; and
- (d) A first-aid kit.

(i) The first-aid kit must contain at least two trauma bandages or equivalent absorbent gauze material and a means to secure the material in place.

(ii) First-aid supplies must be kept clean and dry.

(10) A flagperson(s) must be assigned on roads where hazardous conditions are created from falling trees. Where there is no through traffic, such as on a dead end road, warning signs or barricades may be used instead of a flagperson(s).

(11) One worker must not fall a tree or danger tree when the assistance of another worker is necessary to minimize the risk of injury caused by overhead hazards, loose bark, or interlocked limbs, conditions of the tree, terrain or cutting conditions.

(12) When manual falling or tree jacking, trees must not be felled directly uphill when the probability of the tree sliding back past the stump is likely.

[Statutory Authority: RCW 49.17.010, 49.17.040, 49.17.050, 49.17.060, and chapter 49.17 RCW. WSR 17-17-131, § 296-54-539, filed 8/22/17, effective 10/22/17. Statutory Authority: RCW 49.17.010, [49.17].040 and [49.17].050. WSR 99-17-117, § 296-54-539, filed 8/18/99, effective 12/1/99. Statutory Authority: RCW 49.17.040, [49.17].050 and [49.17].060. WSR 96-22-013, § 296-54-539, filed 10/28/96, effective 1/1/97. Statutory Authority: RCW 49.17.040, 49.17.050, 49.17.240, chapters 43.22 and 42.30 RCW. WSR 80-11-057 (Order 80-15), § 296-54-539, filed 8/20/80. Statutory Authority: RCW 49.17.040, 49.17.150 and 49.17.240. WSR 79-10-081 (Order 79-14), § 296-54-539, filed 9/21/79.]

WAC 296-54-53910 Falling and bucking—Falling. (1) Where felled trees are likely to roll and endanger workers, cutting must proceed from the bottom toward the top of the slope, and uphill from previously fell timber.

(2) A cutter must not be placed on a hillside immediately below another cutter or below other logging operations where there is probable danger.

(3) Cutters must be informed of the movement and location of other employees placed, passing, or approaching the vicinity of trees being fell.

(4) Before falling trees, cutters must:

- (a) Ensure that all personnel are out of reach of the tree; and
- (b) Ensure that all personnel are in the clear of logs, fallen trees, snags, or other trees that may be struck by the falling tree.

(5) While manual falling is in progress, all logging machines must be operated at least two lengths away from trees being manually fell.

EXCEPTION: This provision does not apply to logging machines performing tree pulling operations or logging machines called upon by the cutter to ground hazard trees. All cutters must be notified of the logging machine's entrance into the area and all falling within two tree lengths of the logging machine must stop.

(6) Trees must be fell into the open whenever conditions permit.

(7) Cutters must not fall into another strip; trade leaners on the line.

(8) Knocking over trees larger than six inches in diameter in lieu of cutting is prohibited, except as provided in WAC 296-54-53910(9).

(9) Domino falling of trees, including danger trees, is prohibited. Domino falling does not include the falling of a single danger tree by falling another single tree into it.

(10) Undercuts large enough to safely guide trees and eliminate the possibility of splitting must be used on all trees over six inches DBH.

For example: A tree with no perceptible lean, having an undercut depth of one-fourth of the diameter of the tree and a face opening equal to one-fifth of the diameter of the tree would meet the requirement.

(11) A cutter must place an adequate undercut and leave enough holding wood to ensure the tree will fall in the intended direction.

(12) The two cuts that form the undercut must not cross where they meet, except where a dutchman is required on either side of the cut.

(13) The undercut must not be made while other workers are in an area into which the tree could fall.

(14) A backcut must be made in each tree being fell.

(a) The backcut must be as level as possible;

(b) The backcut must leave enough hinge wood to hold the tree to the stump during most of its fall so that the hinge is able to guide the tree's fall in the intended direction; and

(c) The backcut must be above the level of the horizontal facecut to provide an adequate platform to prevent kickback.

EXCEPTION: This requirement does not apply to open-faced falling where two angled facecuts are used instead of a horizontal facecut.

(d) In tree-pulling operations the backcut may be at or below the undercut hinge point.

(15) Cutting holding wood instead of using wedges is prohibited. Swing cuts are prohibited except by an experienced person.

(16) Trees with face cuts and/or backcuts must not be left standing unless all the following conditions are met:

(a) The cutter clearly marks the tree;

(b) Discontinues work in the hazardous area;

(c) Notifies all workers who might be endangered; and

(d) Takes appropriate measures to ensure that the tree is safely fell before other work is undertaken in the hazardous area.

(17) Undercuts and backcuts must be made at a height above the highest ground level to enable the cutter to safely begin the cut, control the tree, and have freedom of movement for a quick escape from a falling tree.

(18) Lodged trees must be clearly marked and identified by a pre-determined method and all persons in the area must be instructed not to pass or work within two tree lengths of the trees except to ground them.

Note: See Figure No. 2, for illustrations of undercuts.

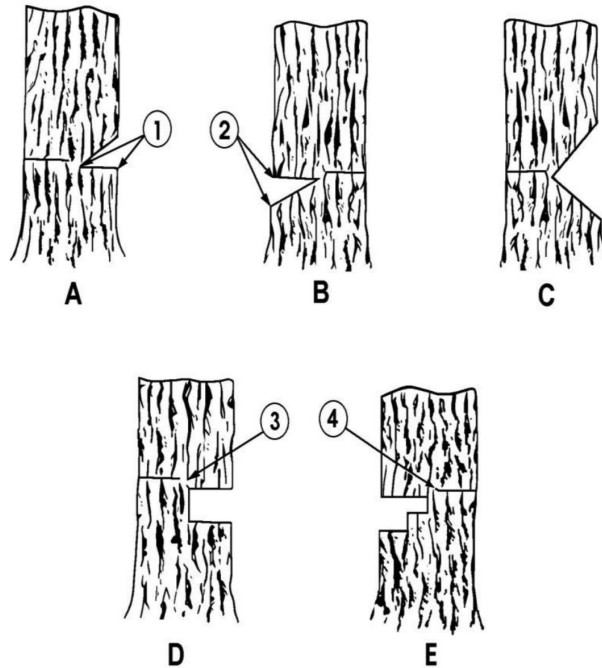

FIGURE 2: UNDERCUTS

- (A) **Conventional undercut.** Can be made with parallel saw cut and axe diagonal cut or both cuts with the saw. Generally used on trees of small diameter.
- (B) **Humboldt undercut.** Leaves square-end log. Same as (A), except that waste is put on the stump.
- (C) **Open face undercut.** Both cuts are made with the saw. The top and bottom face cuts generally form a 90 degree angle when completed. Works best on small diameter trees.
- (D) **Two parallel cuts with the saw.** The material between the cuts is chopped out with an axe-adz (pulaski) combination. Used on trees over 30 inches in diameter.
- (E) **Three parallel cuts with the saw, leaving a step.** Same in principle as (C). Used on trees of very large diameters.

Item	
1	Undercut depth
2	Undercut height
3	Holding wood
4	Backcut

[Statutory Authority: RCW 49.17.010, 49.17.040, 49.17.050, 49.17.060, and chapter 49.17 RCW. WSR 17-17-131, § 296-54-53910, filed 8/22/17, effective 10/22/17. Statutory Authority: RCW 49.17.010, [49.17].040 and [49.17].050. WSR 99-17-117, § 296-54-53910, filed 8/18/99, effective 12/1/99.]

WAC 296-54-53920 Falling and bucking—Bucking. (1) The tree (and root wad if applicable) must be carefully examined to determine which way the logs (and root wad) will roll, drop, or swing when the

cut is completed. No worker shall be allowed in this danger zone during cutting. The cut must be made from a position that will not expose the cutter to potential injury.

(2) Logs must be completely bucked through whenever possible. If it becomes hazardous to complete a cut, then the log must be marked and identified by a predetermined method. Rigging crews must be instructed to recognize such marks and when possible, cutters must warn the rigging crew of locations where unfinished cuts remain.

(3) Cutters must give a timely warning to all persons within range of any log that may have a tendency to roll after being cut off.

[Statutory Authority: RCW 49.17.010, 49.17.040, 49.17.050, 49.17.060, and chapter 49.17 RCW. WSR 17-17-131, § 296-54-53920, filed 8/22/17, effective 10/22/17. Statutory Authority: RCW 49.17.010, [49.17].040 and [49.17].050. WSR 99-17-117, § 296-54-53920, filed 8/18/99, effective 12/1/99.]

WAC 296-54-53930 Falling and bucking—Danger trees. (1) Each danger tree must be carefully checked for signs of loose bark, broken branches and limbs, or other damage before they are fell or removed. Accessible loose bark and other damage that may create a hazard for an employee must be removed or held in place before falling or removing the tree. When a danger tree has elevated loose bark that cannot be removed, the buddy system must be used to watch for and give warning of falling bark or other hazards.

(2) Danger trees that are unsafe to cut must be blown down with explosives or fell by other safe methods.

(3) To avoid use of wedges, which might dislodge loose bark or other material, danger trees should be fell in the direction of lean unless other means (mechanical or dynamite) are used.

[Statutory Authority: RCW 49.17.010, 49.17.040, 49.17.050, 49.17.060, and chapter 49.17 RCW. WSR 17-17-131, § 296-54-53930, filed 8/22/17, effective 10/22/17. Statutory Authority: RCW 49.17.010, [49.17].040 and [49.17].050. WSR 99-17-117, § 296-54-53930, filed 8/18/99, effective 12/1/99.]

WAC 296-54-53940 Falling and bucking—Springboards and tree jacking. (1) Springboards must be:

(a) Made of clear, straight grained sound stock;
(b) Long enough, wide enough, and strong enough; and
(c) Replaced when they will no longer safely support the expected load at the extreme end.

(2) Springboard irons must be well lipped and firmly attached with bolts or other equally strong attachment.

(3) Saw chains must be stopped while shifting springboards.

(4) Jack plates must be used with hydraulic tree jacks and the base plate must be seated on solid wood inside the bark ring as close to level as possible.

(5) When necessary, two workers must be present at the tree during hydraulic tree jacking to lend assistance.

(6) Wedges must be used as a follow-up method while using tree jacks, and continuously moved in as the tree is jacked.

(7) All hydraulic tree jacks must be equipped with a check valve and the pump must be equipped with an operable pressure gauge.

(8) Jacking a tree straight uphill is prohibited when the tree may slide back past the stump.

(9) On slopes over 50% grade, tree(s) must at least be quartered to a degree that prevents employees from being exposed to the possibility of sliding or rolling trees or logs.

(10) Trees must not be felled directly uphill when the probability of the tree sliding past the stump is likely.

[Statutory Authority: RCW 49.17.010, 49.17.040, 49.17.050, 49.17.060, and chapter 49.17 RCW. WSR 17-17-131, § 296-54-53940, filed 8/22/17, effective 10/22/17. Statutory Authority: RCW 49.17.010, [49.17].040 and [49.17].050. WSR 99-17-117, § 296-54-53940, filed 8/18/99, effective 12/1/99.]

WAC 296-54-541 Tree pulling. (1) The cutter must be responsible for determining if a tree can be safely pulled. If, for any reason, the cutter believes the tree pulling cannot be completed safely, the tree must be conventionally fell.

(2) When using a radio, positive radio communications must be maintained at all times between the tree pulling machine and cutter when tree pulling. An audible signal must be blown when the initial pull is made on the tree and the line is tightened. Hand signals, instead of radio communications and an audible signal, may be used only if the cutter is clearly visible to the tree puller operator.

(3) A choker with bell, or a line and sleeve shackle must be used as the means of attachment around the tree when tree pulling. (See also WAC 296-54-54710(4).) The bight on the line must be the minimum necessary to hold the choker or line around the tree.

(4) The tree pulling machine must be equipped with a torque converter, fluid coupler, or an equivalent device to ensure a steady even pull on the line attached around the tree.

(5) The tree pulling line must have as straight and direct path from the machine to the tree as possible. Physical obstructions that prevent a steady even pull on the tree pulling line must be removed or the line must be rerouted.

(6) Using a physical object such as a stump or tree in lieu of a block, in order to change tree pulling lead, is prohibited.

[Statutory Authority: RCW 49.17.010, 49.17.040, 49.17.050, 49.17.060, and chapter 49.17 RCW. WSR 17-17-131, § 296-54-541, filed 8/22/17, effective 10/22/17. Statutory Authority: RCW 49.17.010, [49.17].040 and [49.17].050. WSR 99-17-117, § 296-54-541, filed 8/18/99, effective 12/1/99. Statutory Authority: RCW 49.17.040, 49.17.150 and 49.17.240. WSR 79-10-081 (Order 79-14), § 296-54-541, filed 9/21/79.]

WAC 296-54-543 Mechanized falling. (1) A flagger(s) must be assigned on roads where hazardous conditions are created from falling trees. Where there is no through traffic, such as on a dead end road, warning signs or barricades may be used instead of a flagger(s).

(2) Self-propelled mobile falling equipment used for falling trees must be designed, or have auxiliary equipment installed, that will cause the tree to fall in the intended direction.

(3) Until the machine operator has acknowledged that it is safe to do so, no employee will approach a mechanical falling operation closer than a minimum of two tree lengths of the trees being fell.

(4) Mechanized falling must be conducted in a way that does not endanger people or equipment.

[Statutory Authority: RCW 49.17.010, 49.17.040, 49.17.050, 49.17.060, and chapter 49.17 RCW. WSR 17-17-131, § 296-54-543, filed 8/22/17, effective 10/22/17. Statutory Authority: RCW 49.17.010, [49.17].040 and [49.17].050. WSR 99-17-117, § 296-54-543, filed 8/18/99, effective 12/1/99. Statutory Authority: RCW 49.17.040, 49.17.050, 49.17.240, chapters 43.22 and 42.30 RCW. WSR 80-11-057 (Order 80-15), § 296-54-543, filed 8/20/80. Statutory Authority: RCW 49.17.040, 49.17.150 and 49.17.240. WSR 79-10-081 (Order 79-14), § 296-54-543, filed 9/21/79.]

WAC 296-54-545 Climbing equipment and passline. (1) Standard climbing equipment must be furnished by you. However, the climber may use personal equipment, if it meets the requirements of this section and is permitted by you.

(a) The climber may fasten climbing rope by passing it through "D" rings fastened to the belt and around his body before tying it to itself.

(b) An extra set of climbing equipment must be kept at the job site and another person with climbing experience must be present.

(2) The climber must be equipped with a climbing equipment assembly that includes:

(a) A safety belt with double "D" rings;

(b) Steel spurs long and sharp enough to hold in any tree in which they are used; and

(c) A climbing rope (lanyard) made of a high-quality steel safety chain of 3/16-inch size or larger or a wire core rope.

(3) All climbing equipment must be maintained in good condition.

(4) Defective climbing equipment must be immediately removed from service.

(5) Going up a raised portable spar or tower without suitable equipment is prohibited.

(6) Only an employee directed by the climber may work directly under a tree. The climber must give warning before intentionally dropping any objects or when objects are accidentally dropped.

(7) Running lines must not be moved while the climber is working in the tree, except such "pulls" as climber directs and are necessary for the work.

(8) One experienced person must be assigned to transmit the climber's signals to the machine operator.

(a) This signal person must not otherwise be occupied while the climber is in the tree.

(b) The machine operator must not be distracted while the climber is using the passline.

(c) The designated signal person must be positioned clear of hazards from falling, flying, or thrown objects.

(9) The climber must be an experienced logger with proper knowledge of logging methods and the safety of rigging spar and tail trees.

(10) Noisy equipment such as power saws, tractors, and shovels must not be operated near where a climber is working when such noise will interfere with the climber's signals.

- (11) Climbing and passline equipment must not be used for other purposes.
- (12) Lineman hooks must not be used as spurs.
- (13) Tools used by the climber, except the chain saw, must be safely secured to climber's belt when not in use.
- (14) Using snaps on a climber's rope is prohibited unless a secondary safety device between the belt and snap is used.
- (15) A climber's rope must encircle the tree before the climber leaves the ground, except when the climber is riding the passline.
- (16) While the climber is working in the tree, persons must keep a sufficient distance from the tree to be clear of falling objects.
- (17) When used, passline blocks must be kept in alignment and free from fouling.
- (18) Loose equipment, rigging, or material must either be removed from the tree or securely fastened.
- (19) Drums used for passlines must have enough flange depth to prevent the passline from running off the drum at any time.
- (20) Passlines must:
- (a) Be at least 5/16-inch and not over 1/2-inch in diameter;
 - (b) Not be subjected to sawing on other lines or rigging, and kept clear of all moving lines and rigging;
 - (c) Be one continuous length and in good condition with no splices, knots, molles, or eye-to-eye splices between the ends;
 - (d) Long enough to provide three wraps on the drum before the climber leaves the ground.
- (21) Passline chains must be:
- (a) At least 5/16-inch alloy or 3/8-inch high test chain and must not contain cold shuts or wire strands;
 - (b) Attached to the end of the passline with a screw-pin shackle, a slip-pin shackle with a nut and molle, or a ring large enough to prevent going through the pass block; and
 - (c) Fitted with links or rings to prevent workers from being pulled into the passline block.
- (22) Pass blocks must:
- (a) Be inspected before placing in each spar and the necessary replacements or repairs made before they are hung;
 - (b) Have the shells bolted under the sheaves;
 - (c) Have the bearing pin securely locked and nuts keyed, or the block positively secures the nut and pin;
 - (d) Be equipped with sheaves at least six inches in diameter; and
 - (e) Comply with WAC 296-54-54750.

[Statutory Authority: RCW 49.17.010, 49.17.040, 49.17.050, 49.17.060, and chapter 49.17 RCW. WSR 17-17-131, § 296-54-545, filed 8/22/17, effective 10/22/17. Statutory Authority: RCW 49.17.010, [49.17].040 and [49.17].050. WSR 99-17-117, § 296-54-545, filed 8/18/99, effective 12/1/99. Statutory Authority: RCW 49.17.040, 49.17.150 and 49.17.240. WSR 79-10-081 (Order 79-14), § 296-54-545, filed 9/21/79.]

WAC 296-54-547 Rigging—General. (1) Rigging must be arranged and operated so that rigging and loads will not foul or saw against lines, straps, blocks, or other equipment or material.

(2) When not in use, rigging must be stored so that it does not present a hazard to employees.

(3) Tongs, grapples, logs and materials must not be swung or suspended over employees.

(4) All employees must be in the clear of running lines, standing skylines, moving rigging, or suspended loads until the rigging or loads have completely stopped.

(5) Riding on a turn of logs or rigging is prohibited, except on the passline. Holding on to moving rigging or chokers to be pulled uphill is prohibited.

[Statutory Authority: RCW 49.17.010, [49.17].040 and [49.17].050. WSR 99-17-117, § 296-54-547, filed 8/18/99, effective 12/1/99. Statutory Authority: RCW 49.17.040, 49.17.150 and 49.17.240. WSR 79-10-081 (Order 79-14), § 296-54-547, filed 9/21/79.]

WAC 296-54-54710 Rigging—Inspection. (1) An authorized, qualified person must thoroughly inspect all blocks, straps, guylines, butt rigging, and other rigging before they are used.

(2) The inspections must include examining for:

(a) Damaged, cracked, or worn parts;

(b) Loose nuts and bolts;

(c) Need for lubrication; and

(d) The condition of straps and guylines.

(3) All necessary repairs or replacements for safe operation must be made before the rigging is used.

(4) All rigging elements must be large and strong enough to safely withstand the stress that can be imposed by the maximum pull of the power unit against the equipment or devices as rigged or used in that particular logging operation.

[Statutory Authority: RCW 49.17.010, [49.17].040 and [49.17].050. WSR 99-17-117, § 296-54-54710, filed 8/18/99, effective 12/1/99.]

WAC 296-54-54720 Rigging—Molles. (1) Molles must not be used as a temporary connection between two spliced eyes of a load-supporting running line. Double molles may be used on droplines only and single molles may be used on strawline.

(2) Molles must be as large as the pinhole will accommodate and have the loose ends rolled in.

[Statutory Authority: RCW 49.17.010, [49.17].040 and [49.17].050. WSR 99-17-117, § 296-54-54720, filed 8/18/99, effective 12/1/99.]

WAC 296-54-54730 Rigging—Shackles. (1) Shackles used to hang blocks, jacks, or rigging on spars, must have the pins secured with a nut and cotter key or a nut and molle.

(2) Flush pin, straight-sided shackles must be used for mainline, slackline and skyline extensions.

(3) Shackles with screw pins, knockout or slip pins may be used to anchor skylines, slackline, guyline, and/or guyline extensions.

(4) All other shackles must be screw pin type or have the pin secured with a nut and cotter key or a nut and molle, except as specified elsewhere for specific purposes.

(5) The opening between the jaws of shackles used to hang blocks, jacks, and rigging and to join or attach lines, must not be more than one inch greater than the size of the rope, swivel, or shackle to which it is attached.

(6) All shackles must be one size larger than the lines they connect and made of forged steel or material of equivalent strength.

For example: 1-inch Extra Improved Plow Steel (EIPS) line requires a 1 1/8-inch shackle, 1-inch swaged line require 1 1/4-inch shackle.

(7) Shackles used to join lines must be hung with the pin and "U" part of the shackle through the eyes of the lines.

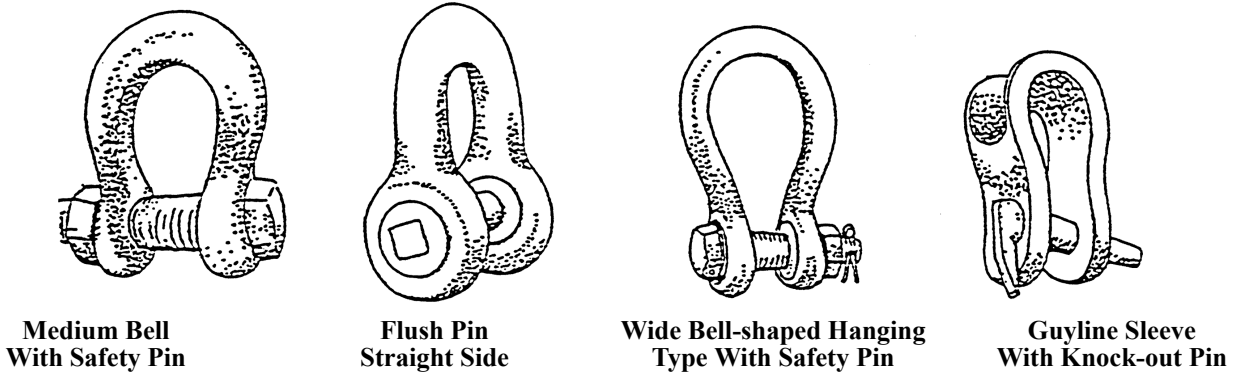

Figure 2-2: Shackles

[Statutory Authority: RCW 49.17.010, 49.17.040, 49.17.050, 49.17.060, and chapter 49.17 RCW. WSR 17-17-131, § 296-54-54730, filed 8/22/17, effective 10/22/17. Statutory Authority: RCW 49.17.010, [49.17].040 and [49.17].050. WSR 99-17-117, § 296-54-54730, filed 8/18/99, effective 12/1/99.]

WAC 296-54-54740 Rigging—Straps. Straps must be used according to the following requirements:

(1) Straps or chokers used to hang corner or tail blocks and straps used to anchor skylines/slacklines must be the size required by Table 1: Strap/Choker Size in Inches.

Table 1: Strap/Choker Size in Inches		
Running Line Size in Inches	Block or Skyline / Slackline Hung in Both Eyes	Block Hung in Single Eye
5/16	1/4	1/2
3/8	3/8	9/16
7/16	7/16	5/8
1/2	1/2	3/4
9/16	9/16	7/8
5/8	5/8	1
3/4	3/4	1 1/8
7/8	7/8	1 1/4
1	1	1 3/8
1 1/8	1	
1 1/4	1	
1 3/8	1	

1 1/2	1 1/8	
1 5/8	1 1/4	
1 3/4	1 1/4	
1 7/8	1 3/8	
2	1 3/8	

Note: Both strap ends must be under equal tension.

(2) Straps/chokers must be equivalently sized for the line they support, e.g., extra improved plow steel (EIPS) line requires EIPS straps or equivalent strength material, and swaged lines require swaged straps or equivalent strength material.

(3) When a single choker or single part strap is used to support lift blocks, jacks and tree shoes they must be adequately sized to support the applied loads.

(4) When a two part strap or two chokers are used to hang a block, jack, tree shoe, or rigging, both eyes or ends must be under equal tension.

(5) Where two equal length chokers are used instead of one choker to gain extra breaking strength, they must be arranged in a swede connection.

(6) Straps or chokers used to hang or support blocks, jacks, tree shoes, or rigging must be replaced when there is evidence of damaged or broken wires. They must:

(a) Be made of new wire rope; or

(b) Meet the pull test strength of new wire rope.

(7) Threading wire rope straps eye through eye is prohibited.

(8) Synthetic straps must be used as recommended by the manufacturer and only at a flat or downward angle unless wrapped one full turn around the tree support to prevent the strap from riding up on the support.

(9) Synthetic straps must be removed from service when wear reaches the limits prescribed by the manufacturer or when deterioration is evident.

[Statutory Authority: RCW 49.17.010, 49.17.040, 49.17.050, 49.17.060, and chapter 49.17 RCW. WSR 17-17-131, § 296-54-54740, filed 8/22/17, effective 10/22/17. Statutory Authority: RCW 49.17.010, [49.17].040 and [49.17].050. WSR 99-17-117, § 296-54-54740, filed 8/18/99, effective 12/1/99.]

WAC 296-54-54750 Rigging—Blocks. (1) Load-bearing blocks must:

(a) Not be used for heavier strains or lines than those for which they are constructed;

(b) Be fitted with line guards;

(c) Be designed and used to prevent fouling;

(d) Be kept in proper alignment when in use;

(e) Be equipped with bearing and yoke pins that will safely withstand the strains imposed, and are securely fastened; and

(f) Be equipped with sheaves designed for the size of the wire rope used.

EXCEPTION: Subsections (b), and (f) do not apply to rig-up ("Tommy Moore") blocks.

(2) Blocks with cracked or excessively worn sheaves or shells must not be used.

(3) Block bearings must be kept well lubricated.

(4) All pins in blocks must be properly secured by "Molle Hogans" or keys of the largest size the pin hole will accommodate. When blocks are hung in spars, pins must be secured with a nut and cotter pin or nut and molle.

(5) Lead blocks used for yarding, swinging, loading and unloading used in wood spars must:

(a) Be of the type and construction designed for this purpose; and

(b) Be bolted with not less than two bolts through the shells below the sheaves in a manner that will retain the sheave and line in case of bearing pin failure (this does not apply to haulback lead blocks).

(6) Mainline blocks must have a sheave diameter of not less than twenty times the diameter of the mainline.

[Statutory Authority: RCW 49.17.010, 49.17.040, 49.17.050, 49.17.060, and chapter 49.17 RCW. WSR 17-17-131, § 296-54-54750, filed 8/22/17, effective 10/22/17. Statutory Authority: RCW 49.17.010, [49.17].040 and [49.17].050. WSR 99-17-117, § 296-54-54750, filed 8/18/99, effective 12/1/99.]

WAC 296-54-54760 Rigging—Hanging blocks. (1) All logging systems must use enough corner or tail blocks to distribute the stress on anchors and attachments.

(2) Blocks (other than passline or haywire) must be hung by one of the following methods:

(a) Hanging the block in both eyes or Ds of the straps (threading eye through eye of wire rope straps is prohibited);

(b) If chokers are used, the ferrule must be properly seated in the socket of the bell or hook to prevent the ferrule from coming unbuttoned. The chokers must be the size required in WAC 296-54-54740(1); or

(c) If single part straps are used, the straps must be secured with a shackle and be the size required in WAC 296-54-54740(1).

(3) The yoke pin of haulback blocks must be inserted with the head facing the direction from which the rigging approaches.

(4) When there is danger of tail block straps slipping up or off the stump or tree, the stump or tree must be adequately notched or the line properly wrapped and secured. When the tail tree or stump is not secure, it must be tied back.

[Statutory Authority: RCW 49.17.010, 49.17.040, 49.17.050, 49.17.060, and chapter 49.17 RCW. WSR 17-17-131, § 296-54-54760, filed 8/22/17, effective 10/22/17. Statutory Authority: RCW 49.17.010, [49.17].040 and [49.17].050. WSR 99-17-117, § 296-54-54760, filed 8/18/99, effective 12/1/99.]

WAC 296-54-54770 Chokers and butt rigging. (1) Chokers must be at least one size smaller than the mainline. If a dropline is used it must have a breaking strength equal to a line one size smaller than the mainline.

(2) All butt hook rigging must be used in a manner to prevent loss of the choker.

(3) Molles or cold shuts are prohibited in butt rigging as a load bearing connection.

[Statutory Authority: RCW 49.17.010, [49.17].040 and [49.17].050. WSR 99-17-117, amended and recodified as § 296-54-54770, filed 8/18/99, effective 12/1/99. Statutory Authority: RCW 49.17.040, [49.17].050 and [49.17].060. WSR 96-22-013, § 296-54-559, filed 10/28/96, effective 1/1/97. Statutory Authority: Chapter 49.17 RCW. WSR 88-23-054 (Order 88-25), § 296-54-559, filed 11/14/88. Statutory Authority: RCW 49.17.040 and 49.17.050. WSR 81-05-013 (Order 81-3), § 296-54-559, filed 2/10/81. Statutory Authority: RCW 49.17.040, 49.17.150 and 49.17.240. WSR 79-10-081 (Order 79-14), § 296-54-559, filed 9/21/79.]

WAC 296-54-549 Selecting spar, tail and intermediate support trees. (1) Spar, tail and intermediate support trees must be examined carefully for defects before being selected. They must be sound, straight, green and of sufficient diameter to withstand the strains to be imposed.

(2) Trees having defects that impair their strength must not be used for spar, tail or intermediate support trees. Raised trees must be identified and marked as such.

(3) Douglas fir or spruce must be used as spar trees when available. If other species must be used, additional guylines, tree plates or other precautions must be taken to ensure that the tree will withstand the strains to be imposed.

[Statutory Authority: RCW 49.17.010, [49.17].040 and [49.17].050. WSR 99-17-117, § 296-54-549, filed 8/18/99, effective 12/1/99. Statutory Authority: RCW 49.17.040, 49.17.050, 49.17.240, chapters 43.22 and 42.30 RCW. WSR 80-11-057 (Order 80-15), § 296-54-549, filed 8/20/80. Statutory Authority: RCW 49.17.040, 49.17.150 and 49.17.240. WSR 79-10-081 (Order 79-14), § 296-54-549, filed 9/21/79.]

WAC 296-54-551 Raising and lowering portable spars or towers. (1) A qualified, authorized person must direct each raising and lowering of a portable spar or tower.

(2) All employees not engaged in the raising or lowering of portable spars must stay in the clear during these operations.

(3) Portable spars must be leveled to provide proper line spooling and avoid excessive stress on component parts.

[Statutory Authority: RCW 49.17.010, [49.17].040 and [49.17].050. WSR 99-17-117, § 296-54-551, filed 8/18/99, effective 12/1/99. Statutory Authority: RCW 49.17.040, [49.17].050 and [49.17].060. WSR 96-22-013, § 296-54-551, filed 10/28/96, effective 1/1/97. Statutory Authority: RCW 49.17.040, 49.17.050, 49.17.240, chapters 43.22 and 42.30 RCW. WSR 80-11-057 (Order 80-15), § 296-54-551, filed 8/20/80. Statutory Authority: RCW 49.17.040, 49.17.150 and 49.17.240. WSR 79-10-081 (Order 79-14), § 296-54-551, filed 9/21/79.]

WAC 296-54-553 Metal spars. (1) Each portable metal spar must have an identification plate permanently attached to its base or on the yarder in a position that can be easily read by a person standing on the ground or on the base platform.

EXCEPTION: A hydraulic loader with yarding drums is not required to have an identification plate if the drums are installed and used according to the manufacturer's recommendations.

(2) The identification plate must have the following information:

(a) Name and address of manufacturer;

(b) Model number; and

(c) The maximum and minimum angle at which the metal spar is designed to operate.

(3) The identification plate on metal spars manufactured after July 1, 1980, must also have the following information:

(a) The maximum breaking strength and/or size of the mainline for which the spar is designed;

(b) The maximum breaking strength and/or size of the haulback line for which the spar is designed;

(c) The number, breaking strength, and size of guylines or any other lines required; and

(d) For a spar designed for a skyline, slackline, or modified slackline system, the maximum breaking strength and size of the skyline, mainline, and haulback line that can be used.

(4) All portable metal spars must be operated within the manufacturer's capacity:

(a) As specified on the identification plate; or

(b) As modified by the manufacturer; or

(c) As designed and specified by a registered engineer; or

(d) A tension limiting device must be installed on the yarder.

The device must be:

(i) Designed to automatically slack the skyline or mainline to within the manufacturer's line strength specifications;

(ii) Tamper proof;

(iii) Inspected; and

(iv) Maintained in good operating condition; or

(e) A line fuse installed in the skyline or mainline. Line fused systems must have a design breaking strength equal to or less than the maximum line rating of the spar as listed on its identification plate.

Note: Item (d) and (e) list options to follow when using wire rope which exceeds the manufacturer's line strength specifications.

(5) Equipment used for yarding, which is specifically designed to be self-stabilizing during operation, may be used without guyline(s) provided the equipment is used with guylines when required by the manufacturer.

(6) Portable spars or towers and their parts must be inspected by a qualified person whenever:

(a) The portable spar or tower is lowered;

(b) Its safe condition is in doubt; or

(c) When damage from over-stress or any other source is noted or suspected. Before being used again, the part in question must be inspected by a suitable method and:

(i) Found safe;

(ii) Repaired by a qualified person; or

(iii) Replaced.

(7) Any structural modifications or additions that affect the capacity or safe operation of metal spars must be made under the direction of the manufacturer or a registered professional engineer. If such modifications or additions are made, the identification plate required in this section must reflect such changes.

(8) When moving metal spar logging machines, the spar must be lowered.

EXCEPTION: The spar may be raised when necessary for mobility if it is adequately supported to ensure the stability of the machine during movement.

[Statutory Authority: RCW 49.17.010, [49.17].040 and [49.17].050. WSR 99-17-117, § 296-54-553, filed 8/18/99, effective 12/1/99. Statutory Authority: RCW 49.17.040, [49.17].050 and [49.17].060. WSR 96-22-013, § 296-54-553, filed 10/28/96, effective 1/1/97. Statutory Authority: RCW 49.17.040, 49.17.150 and 49.17.240. WSR 79-10-081 (Order 79-14), § 296-54-553, filed 9/21/79.]

WAC 296-54-555 Metal spar guyline safety straps. (1) A metal spar guyline safety strap or equivalent device must be installed at the bight of the guylines to prevent guylines from falling vertically more than five feet in case of structural or mechanical failure of the guyline attachment.

(2) The safety strap or equivalent devices must be equal to the strength of one guyline being used.

(3) Using cable clips or clamps to join the ends of portable spar or tower guyline safety straps is prohibited, unless used to secure the end of a farmer's eye.

[Statutory Authority: RCW 49.17.010, [49.17].040 and [49.17].050. WSR 99-17-117, § 296-54-555, filed 8/18/99, effective 12/1/99. Statutory Authority: RCW 49.17.040, [49.17].050 and [49.17].060. WSR 96-22-013, § 296-54-555, filed 10/28/96, effective 1/1/97. Statutory Authority: RCW 49.17.040 49.17.050, 49.17.240, chapters 43.22 and 42.30 RCW. WSR 80-11-057 (Order 80-15), § 296-54-555, filed 8/20/80. Statutory Authority: RCW 49.17.040 49.17.150 and 49.17.240. WSR 79-10-081 (Order 79-14), § 296-54-555, filed 9/21/79.]

WAC 296-54-557 Wire rope. (1) Wire rope must be of the same or better grade as originally recommended by the equipment manufacturer.

(2) Wire rope must be removed from service when any of the following conditions exist:

(a) In running ropes, six randomly distributed broken wires in one lay or three broken wires in one strand in one lay;

(b) Wear of one-third the original diameter of outside individual wires. Kinking, crushing, birdcaging, or any other damage resulting in distortion of the rope structure;

(c) Evidence of any heat damage from any cause;

(d) Reductions from nominal diameter of more than 3/64-inch for diameters to and including 3/4-inch, 1/16-inch for diameters 7/8-inch to 1-1/8-inch, inclusive, 3/32-inch for diameters 1-1/4-inches to 1-1/2-inches inclusive;

(e) In standing ropes, more than two broken wires in one lay in sections beyond end connections or more than one broken wire at an end connection; and

(f) Corroded, damaged, or improperly applied end connections.

EXCEPTION: Out-of-service requirements do not apply to chokers, grapple opening lines, tag lines, cat and skidder winch lines, and drop lines that are not used to move the carriage. However, an authorized, qualified person must thoroughly inspect these cables adhering to the requirements of WAC 296-54-54710 (1) and (3).

(3) Wire rope must be kept lubricated as conditions of use require.

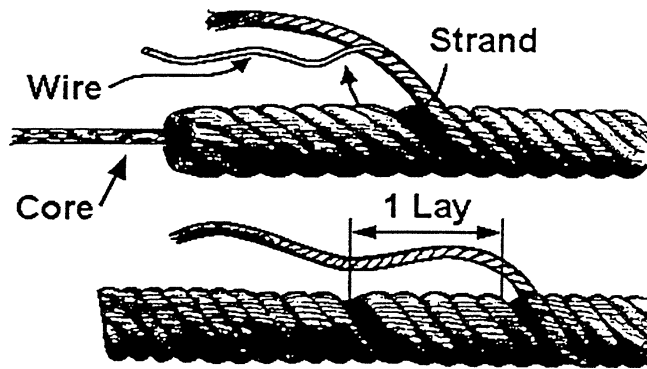

Wire rope selection is an important element in cable logging.

WIRE ROPE

[Statutory Authority: RCW 49.17.010, 49.17.040, 49.17.050, 49.17.060, and chapter 49.17 RCW. WSR 17-17-131, § 296-54-557, filed 8/22/17, effective 10/22/17. Statutory Authority: RCW 49.17.010, 49.17.040, 49.17.050, 49.17.060. WSR 06-07-142, § 296-54-557, filed 3/21/06, effective 5/1/06. Statutory Authority: RCW 49.17.010, [49.17].040 and [49.17].050. WSR 99-17-117, § 296-54-557, filed 8/18/99, effective 12/1/99. Statutory Authority: RCW 49.17.040, [49.17].050 and [49.17].060. WSR 96-22-013, § 296-54-557, filed 10/28/96, effective 1/1/97. Statutory Authority: RCW 49.17.040, 49.17.050, 49.17.240, chapters 43.22 and 42.30 RCW. WSR 80-11-057 (Order 80-15), § 296-54-557, filed 8/20/80. Statutory Authority: RCW 49.17.040, 49.17.150 and 49.17.240. WSR 79-10-081 (Order 79-14), § 296-54-557, filed 9/21/79.]

WAC 296-54-55710 Wire rope—Cutting. (1) Hard hammers must not be used for cutting cable with a wire ax or when splicing.
 (2) Employees must wear eye protection when cutting lines.

[Statutory Authority: RCW 49.17.010, [49.17].040 and [49.17].050. WSR 99-17-117, § 296-54-55710, filed 8/18/99, effective 12/1/99.]

WAC 296-54-55720 Wire rope—Splicing. (1) Marlin spikes must be used for splicing. The marlin spikes must be:
 (a) Large enough for the size of the line being spliced; and
 (b) Maintained in good condition.
 (2) Short splices, eye-to-eye splices, cat's paws, and knots are prohibited except for moving nonload-bearing lines. Knots may be used on single drum tractors, grapple pickup lines, and dropline carriage systems using slider bells if the knot is tied on the end of the dropline.
 (3) Wire rope one-half inch in diameter or less must be tucked at least two times provided the rope is used only as a strawline.
 (4) Eye splices in all regular lay lines and straps must be tucked at least three times.
 (5) Eye splices in lang lay lines must be tucked at least four times.
 (6) Splices, other than eye splices, in lang lay loading lines are prohibited.

(7) Long splices must be used to permanently join regular lay running line.

(8) The length of line strand to be unraveled to make a long splice in wire rope must be as shown in Table 2: Length of Line Strand. The full length of the splice is twice the length of the rope to be unraveled.

Table 2: Length of Line Strand

Rope Diameter	To Be Unraveled	Total Length
1/4"	8'	16'
3/8"	8'	16'
1/2"	10'	20'
5/8"	13'	26'
3/4"	15'	30'
7/8"	18'	36'
1"	20'	40'
1-1/8"	23'	46'
1-1/4"	25'	50'
1-3/8"	28'	56'
1-1/2"	30'	60'
1-5/8"	33'	66'
1-3/4"	35'	70'
1-7/8"	38'	76'
2"	40'	80'

Note: Unraveling 40 lays of cable on each side will give the required length of splice regardless of the diameter.

[Statutory Authority: RCW 49.17.010, 49.17.040, 49.17.050, 49.17.060, and chapter 49.17 RCW. WSR 17-17-131, § 296-54-55720, filed 8/22/17, effective 10/22/17. Statutory Authority: RCW 49.17.010, [49.17].040 and [49.17].050. WSR 99-17-117, § 296-54-55720, filed 8/18/99, effective 12/1/99.]

WAC 296-54-55730 Wire rope—Attaching end fastenings. (1) The manufacturer's recommendations must be followed when attaching sockets and other end fastenings.

(2) Using cable clips or clamps for joining lines is prohibited, except to transfer slack lines from one place to another.

(3) When U-bolt cable clips are used to form eyes, Table 3: U-bolt Cable Clips to Form Eyes must be used to determine the number and spacing of clips.

Table 3: U-bolt Cable Clips to Form Eyes

Improved Plow Steel Diameter of Rope	Number of Clips Forged	Required Other Material	Minimum Space Between Clips
3/8 to 5/8 inch	3	4	-3/4 inch
3/4 inch	4	5	4-1/2 inch
7/8 inch	4	5	5-1/4 inch
1 inch	5	6	6 inches
1-1/8 inch	6	6	6-3/4 inch

Improved Plow Steel Diameter of Rope	Number of Clips Forged	Required Other Material	Minimum Space Between Clips
1-1/4 inch	6	7	7-1/2 inch
1-3/8 inch	7	7	8-1/4 inch
1-1/2 inch	7	8	9 inches

(4) When U-bolt cable clips are used:

(a) For eye splices, the U-bolt wire rope clip must be attached so that the U section is in contact with the dead or short end of the rope (see Figure 3: Eyes Formed with U-bolt Cable Clips);

(b) U-bolt cable clips must be spaced at least six rope diameters apart to obtain the maximum holding power. Nuts must be tightened evenly and tightened again after application of the first sustained load. After the rope has been used and is under tension, the clips must be tightened again to take up any looseness caused by the tension reducing the rope diameter;

(c) With high strength wire rope, one more U-bolt cable clip must be added for each grade above improved plow steel; and

(d) Eyes formed with U-bolt cable clips are prohibited with running lines or straps.

(5) Wedge-type quick ferrules, such as "quick nub" must not be used as end fittings for guylines and skylines.

APPLICATION OF WIRE ROPE

U-BOLT CLIPS

Crosby Type



1. CORRECT METHOD—U-Bolts of clips on short end of rope. (No distortion on live end of rope)



2. WRONG METHOD—U-Bolts on live end of rope. (This will cause mashed spots on the live end of rope)



3. WRONG METHOD—Staggered clips; two correct and one wrong. (This will cause a mashed spot in live end of rope due to wrong position of center clip)

4. After rope is in service, and is under tension, tighten clips to take up decrease in rope diameter.

Figure 3: Eyes Formed with U-bolt Cable Clips

[Statutory Authority: RCW 49.17.010, 49.17.040, 49.17.050, 49.17.060, and chapter 49.17 RCW. WSR 17-17-131, § 296-54-55730, filed 8/22/17,

effective 10/22/17. Statutory Authority: RCW 49.17.010, [49.17].040 and [49.17].050. WSR 99-17-117, § 296-54-55730, filed 8/18/99, effective 12/1/99.]

WAC 296-54-561 Guylines. (1) Guylines must be used with any logging equipment when required by the equipment manufacturer.

(2) At least the minimum number and angle of guylines recommended by the equipment manufacturer must be used.

(3) Unless otherwise specified by the equipment manufacturer, guylines must be of the following sizes:

(a) In highlead logging, the head spar guylines must be equal in breaking strength to the mainline.

(b) In skyline logging, if the skyline is one and three-eighths inch or greater, the head spar guylines must be at least one and three-eighths inch. If the skyline is less than one and three-eighths inch, the head spar guylines must be equal in breaking strength to the skyline.

(c) On all other cable logging machines, the guylines must have a breaking strength at least equal to the mainline/skyline, whichever is largest.

(d) Tail/lift and intermediate support trees must be adequately guyed to withstand any stress to which the tree may be subjected.

(4) When guylines are required for spars they must be positioned according to Table 4: Guyline Positioning, or according to the manufacturer's specifications.

Table 4: Guyline Positioning

Number of Guys on Spar	Number of Guys Sharing Load	Positioning Figure Number
1	1	4 - 1 Guyline Case
2	2	5 - 2 Guyline Case
3	3*	6 - 3 Guyline Case
	2	7 - 3 Guyline Case (2)
4	2	8 - 4 Guyline Case
5	2	9 - 5 Guyline Case
	3	10 - 5 Guyline Case (2)
6	2	11 - 6 Guyline Case
	3	12 - 6 Guyline Case (2)
7	3	13 - 7 Guyline Case
8	2	14 - 8 Guyline Case
	4	15 - 8 Guyline Case (2)

* For metal spars designed to operate without snap guy

(5) Guylines supporting metal spars must be made of plow steel or better material and must be maintained in good condition. Guylines for tail/lift and intermediate support trees may be made of synthetic material and must be used according to the manufacturer's recommendations.

(6) Load bearing guyline angles must be no greater than fifty degrees measured horizontally (See Figure 18: Maximum Angle for Load Bearing Guylines and Skyline). If suitable anchors are unavailable or the terrain is so steep that the guyline angle exceeds fifty degrees, an additional guyline must be rigged to oppose the load.

(7) Guylines must be kept securely tightened while the spar, tree, equipment or rigging they support is in use.

(8) Power driven devices must be securely anchored when used to tighten guylines. Holding such devices is prohibited.

(9) All trees that interfere with proper alignment, placement, or tightening of guylines must be felled.

EXCEPTION: It is acceptable to use the base of a tree/stump or ground conditions to change the lead of a guyline for the purpose of keeping the guyline properly positioned.

(10) Guylines must be hung in a manner to prevent an excessive bight or fouling when they are tightened.

(11) The use of loops or molles for attaching guylines is prohibited.

(12) The U part of shackles or sleeves must be around the guyline and the pin passed through the eye of the guyline.

(13) Splicing of guylines is prohibited except to make an eye splice.

(14) All spliced guyline eyes must be tucked at least three times.

(15) Extensions to guylines must be:

(a) Equal in breaking strength to the guyline to which they are attached; and

(b) Connected only by a shackle connecting two spliced eyes, pressed eyes or by double-end hooks. Connections must have at least one and one-half times the strength of the guyline.

(16) When hanging a block or jack on a guyline, only sleeve-type safety pin shackles must be used. The shackle sleeve will have not less than two and one-half times the line diameter bearing on the guyline.

1 GUYLINE CASE

QUADRANT 1

Load

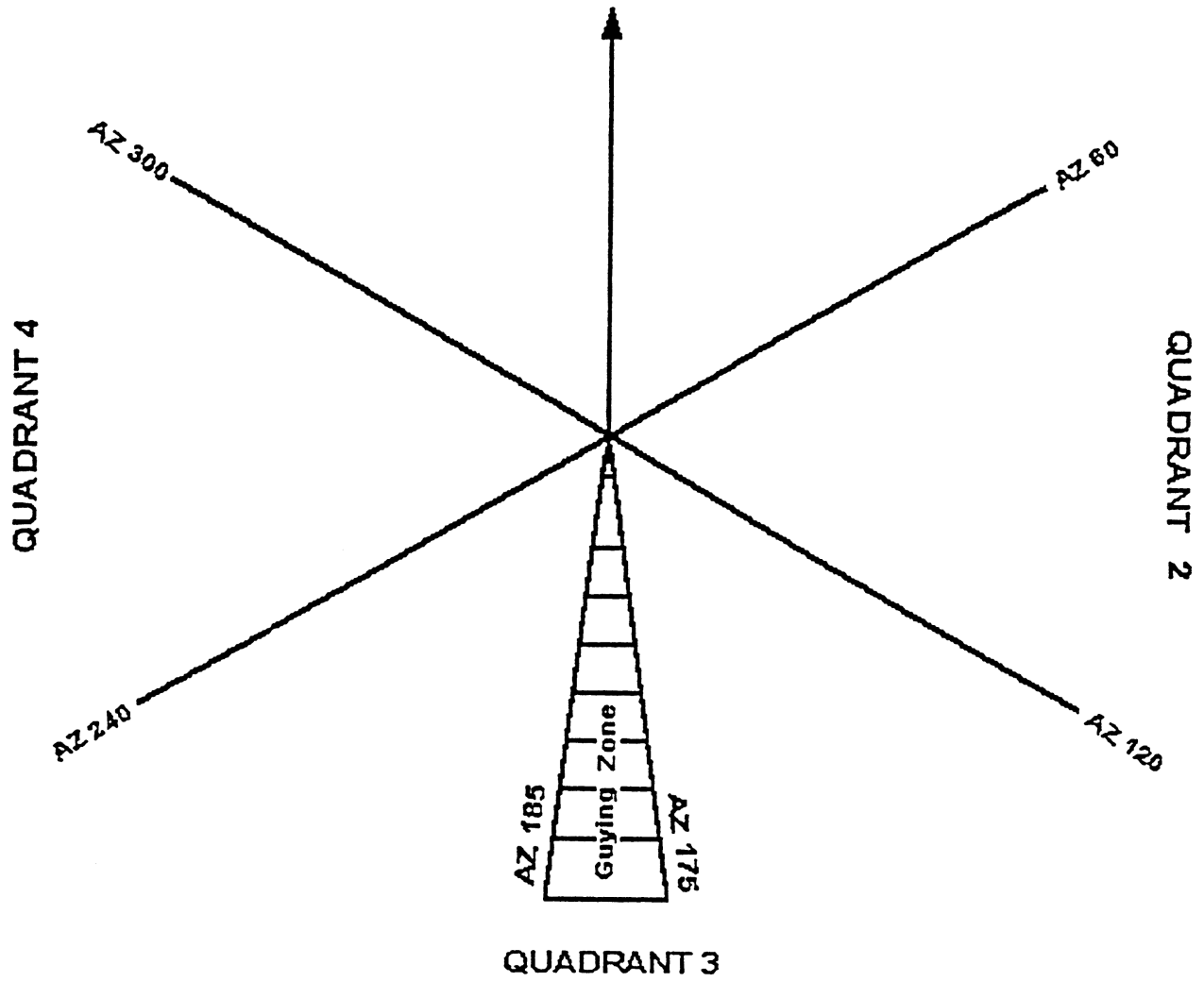

QUADRANT 3

Figure 4: 1 Guyline Case

2 GUYLINE CASE

QUADRANT 1

LOAD

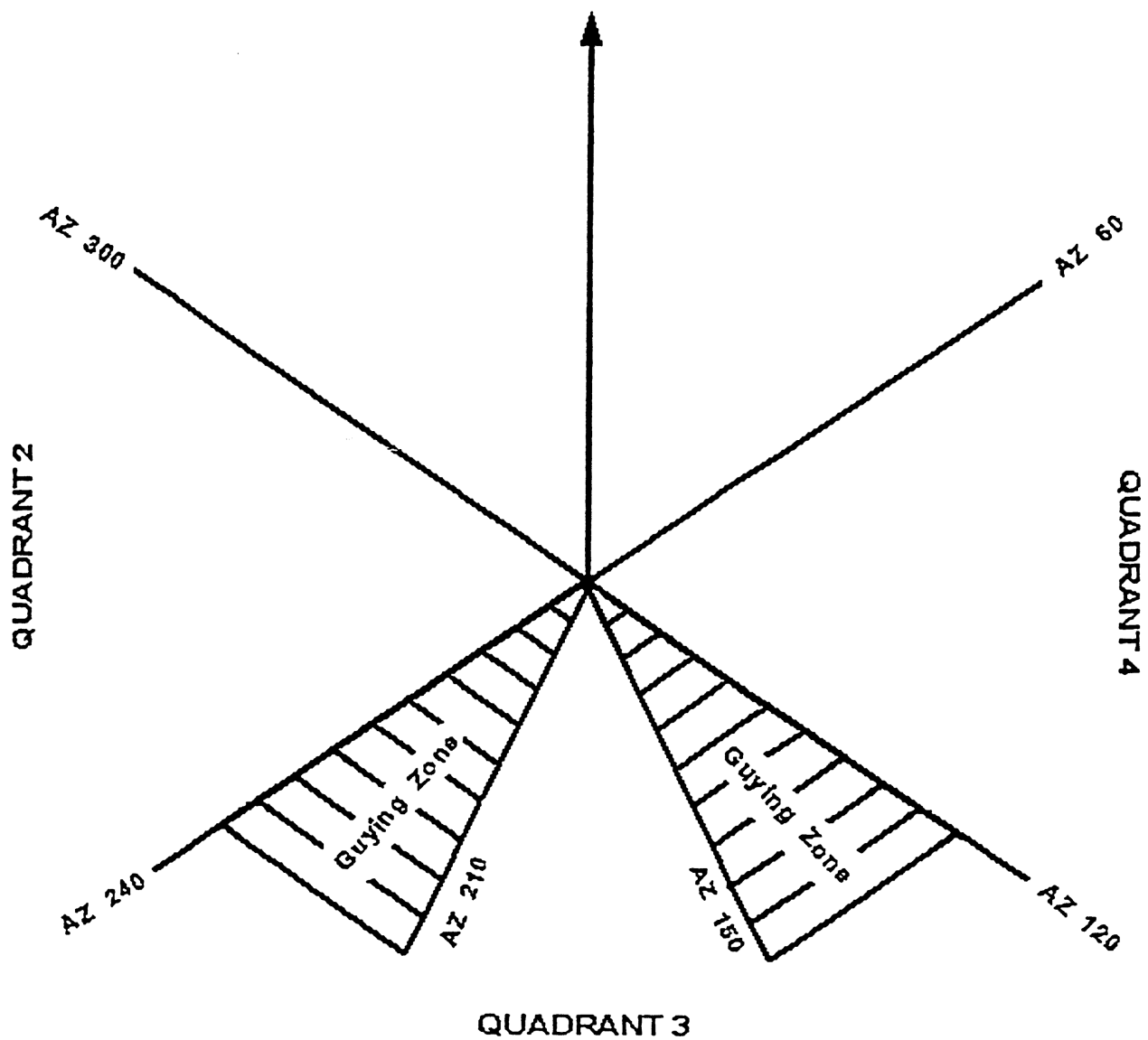

Figure 5: 2 Guyline Case

3 GUYLINE CASE

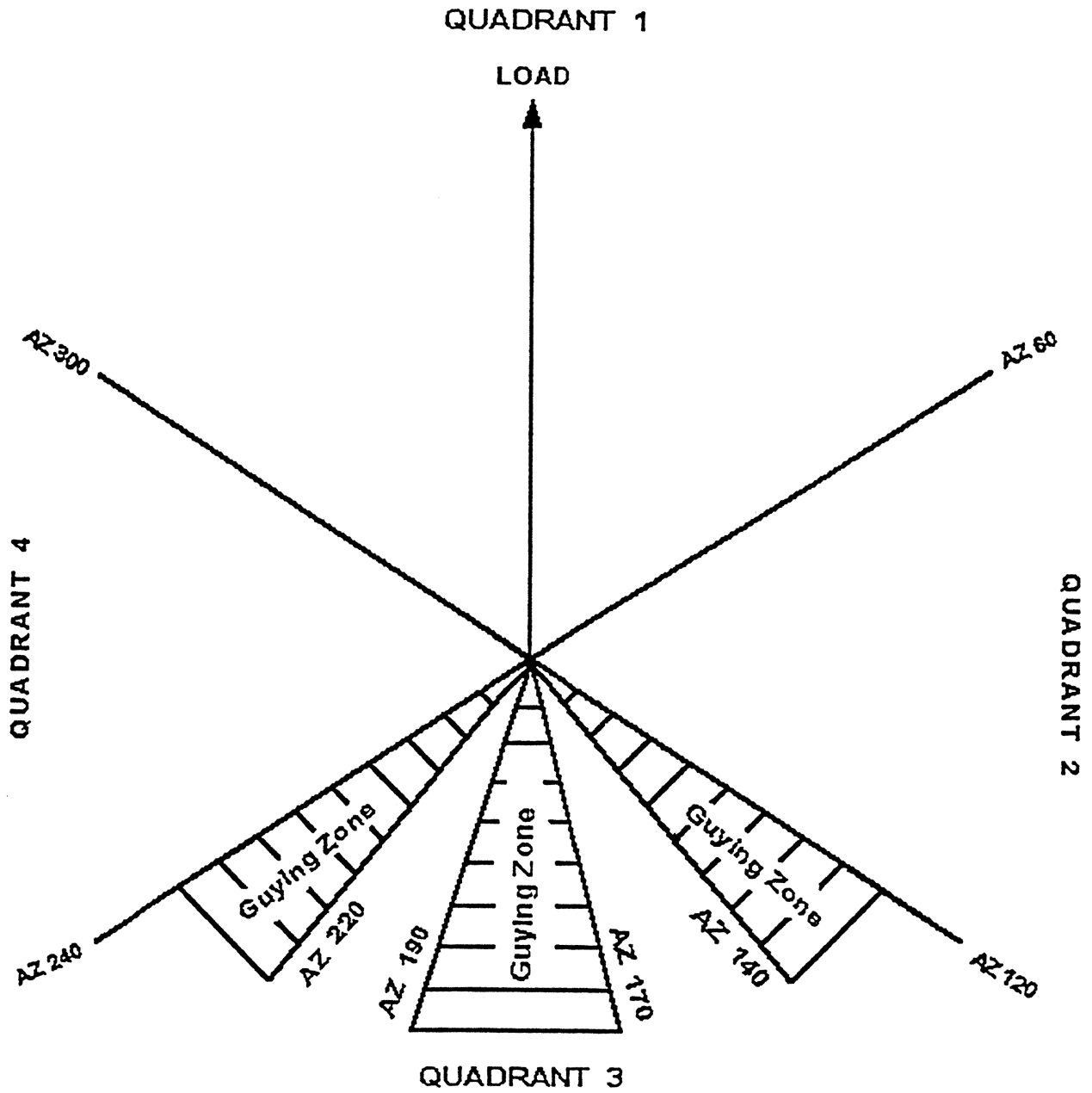

Figure 6: 3 Guyline Case

3 GUYLINE CASE

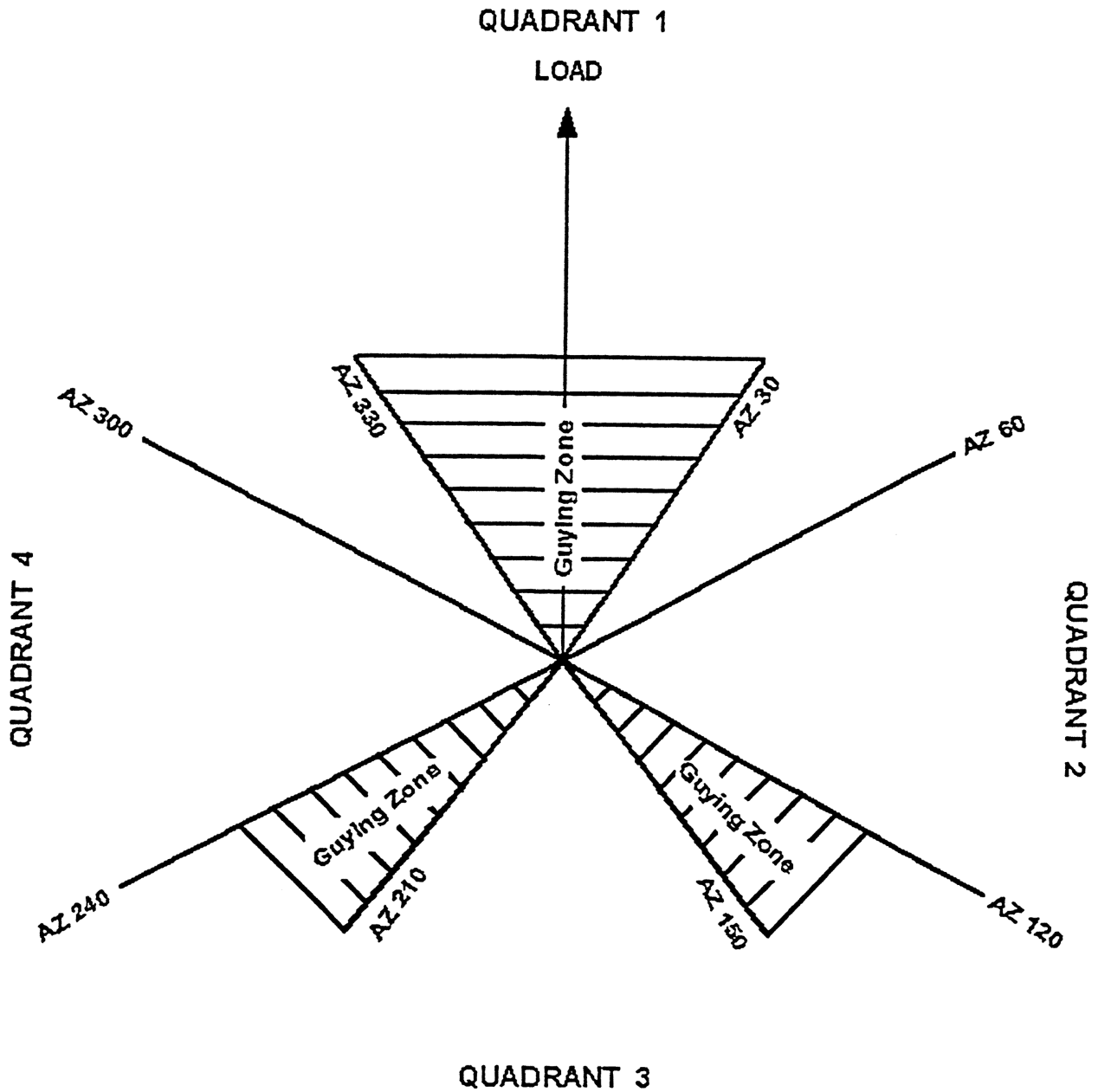
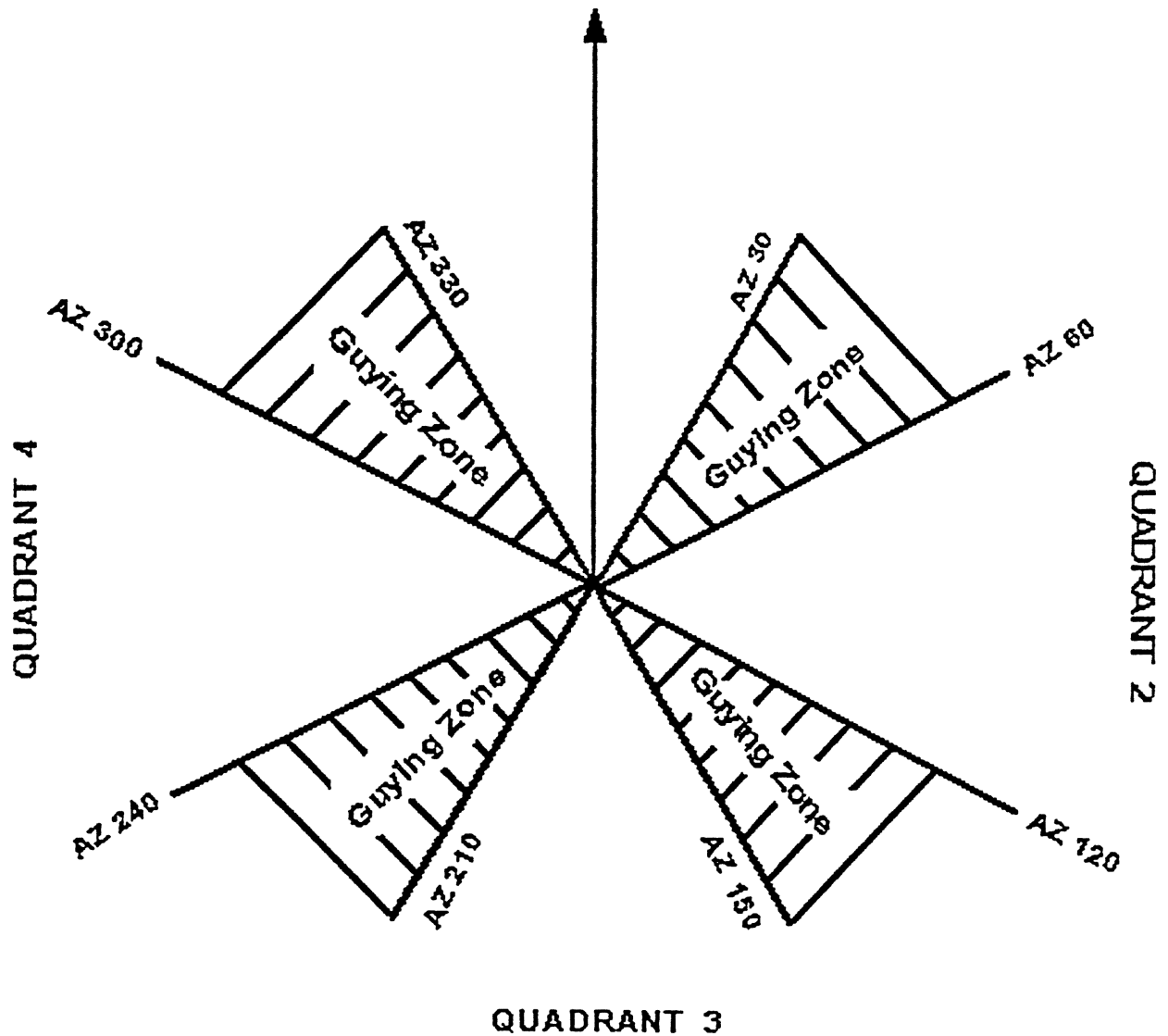

Figure 7: 3 Guyline Case (2)

4 GUYLINE CASE

QUADRANT 1

Load



QUADRANT 3

Figure 8: 4 Guyline Case

5 GUYLINE CASE

QUADRANT 1

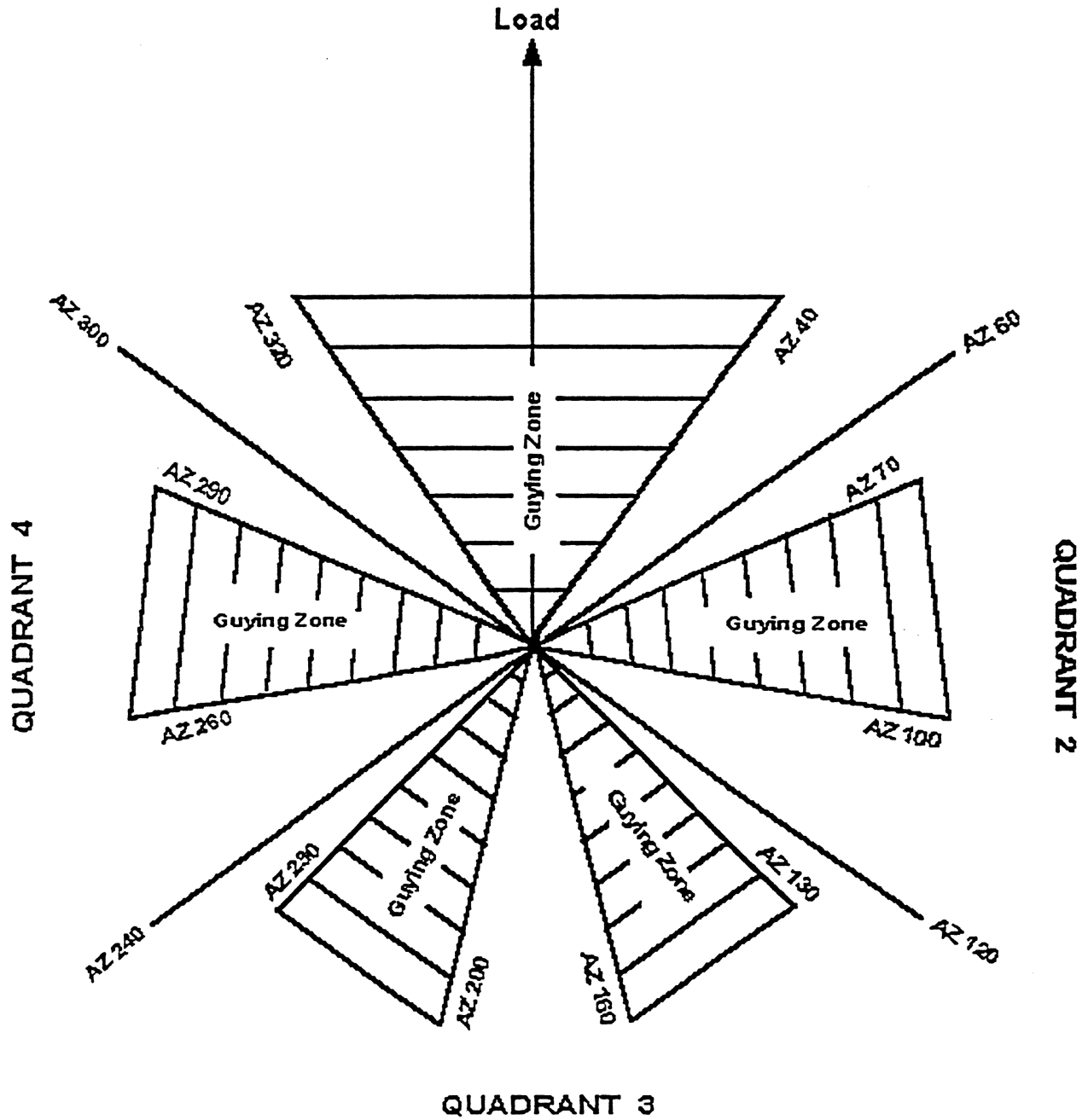

Figure 9: 5 Guyline Case

5 GUYLINE CASE

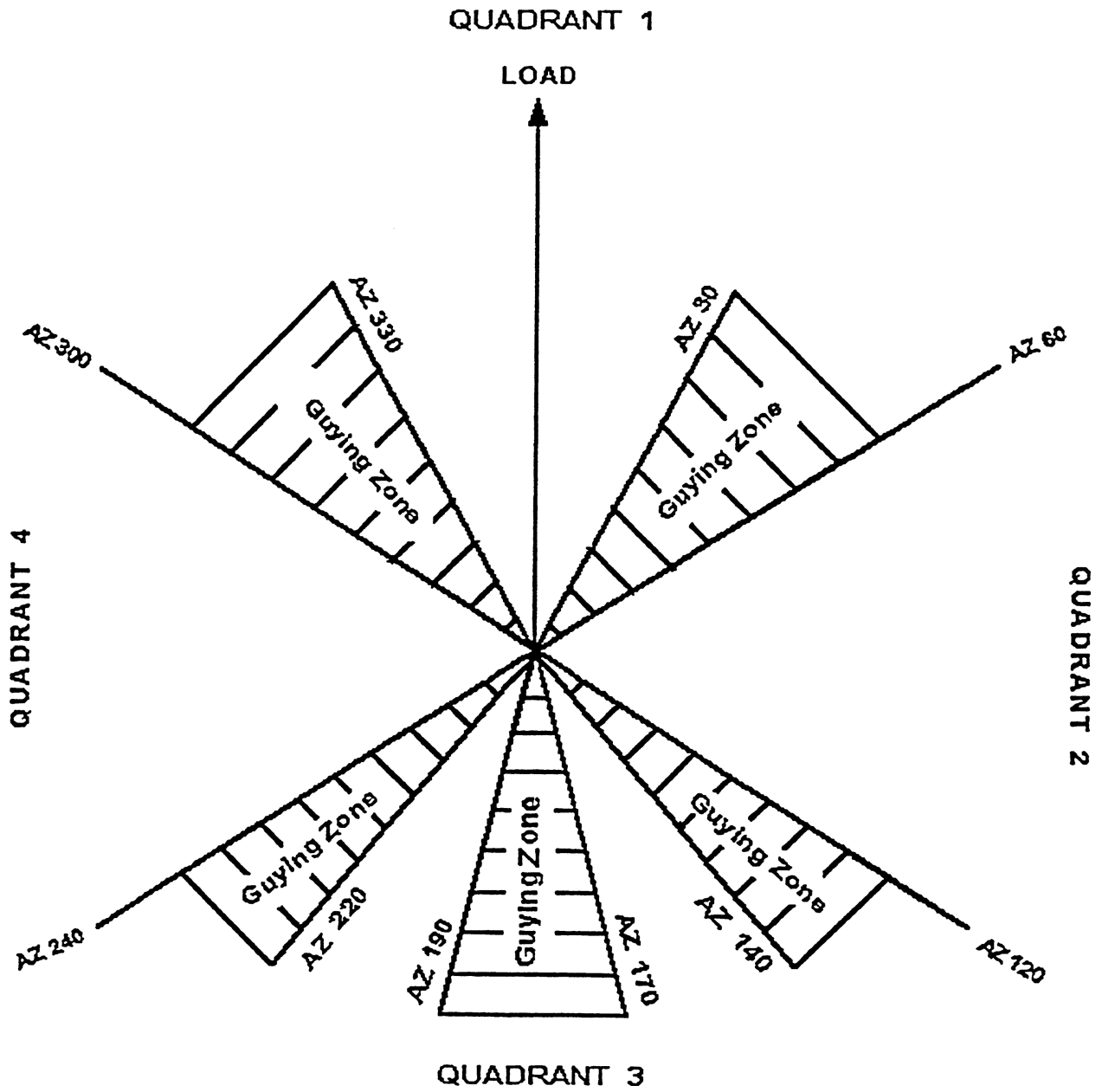

Figure 10: 5 Guyline Case (2)

6 GUYLINE CASE

QUADRANT 1

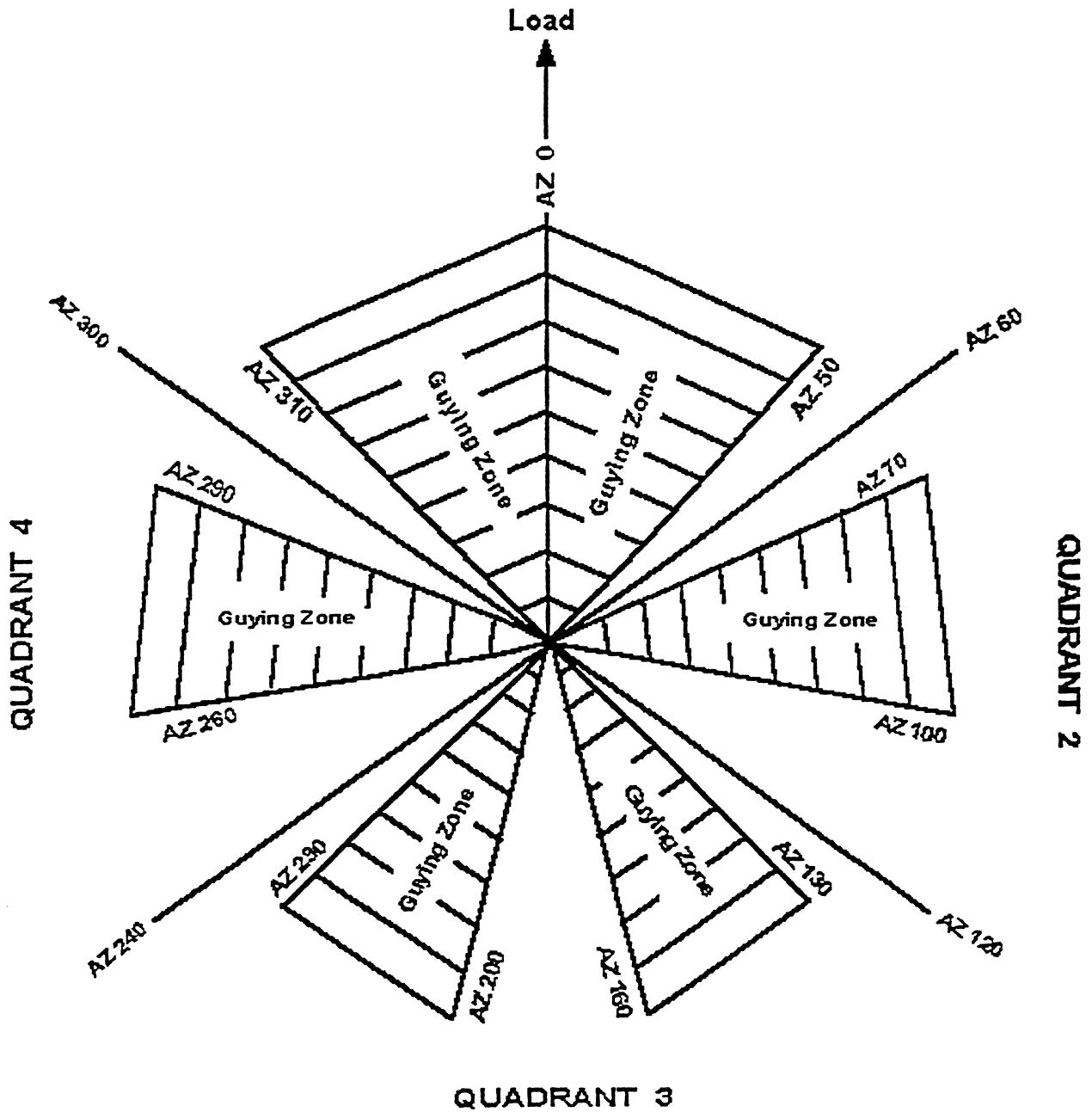

Figure 11: 6 Guyline Case

6 GUYLINE CASE

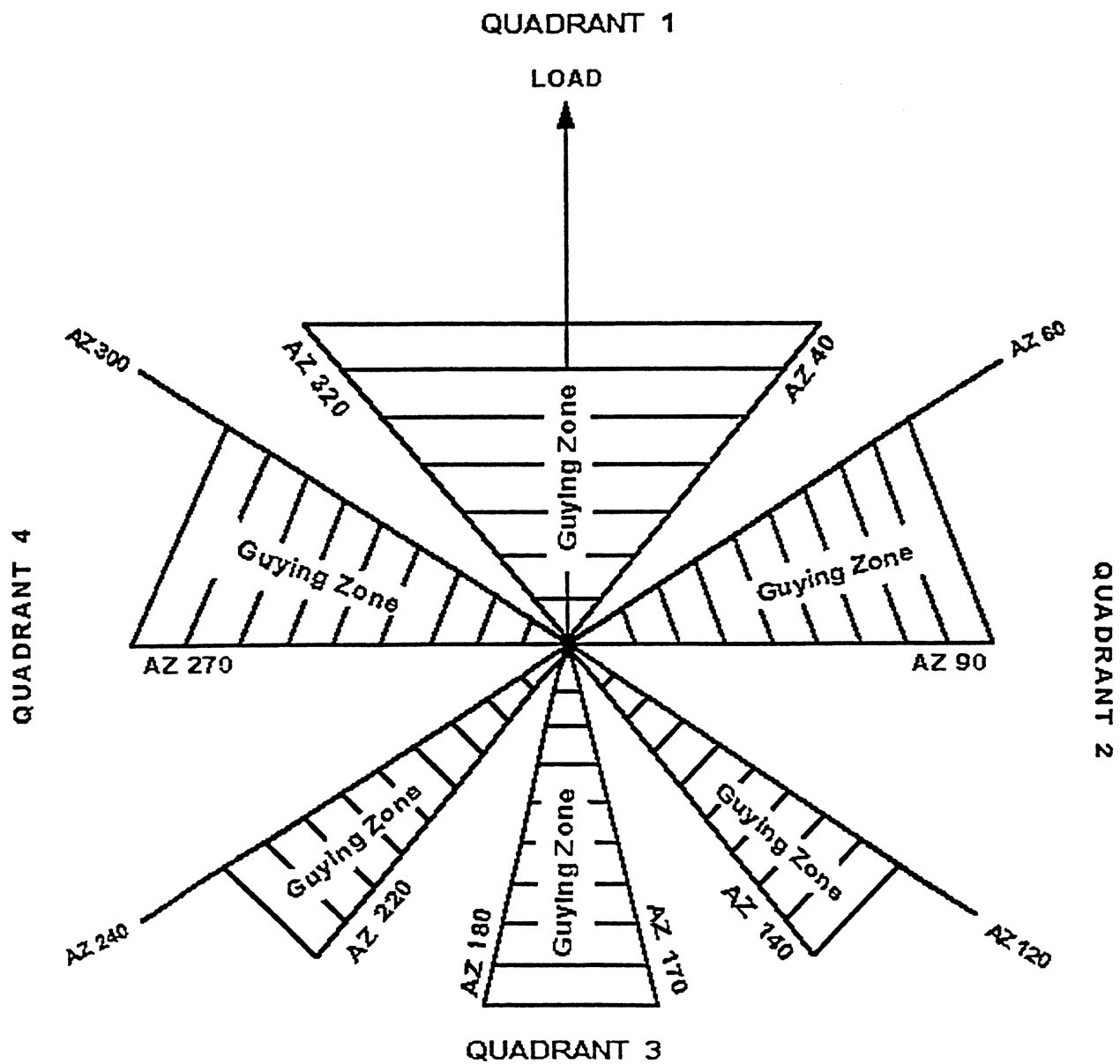

Figure 12: 6 Guyline Case (2)

7 GUYLINE CASE

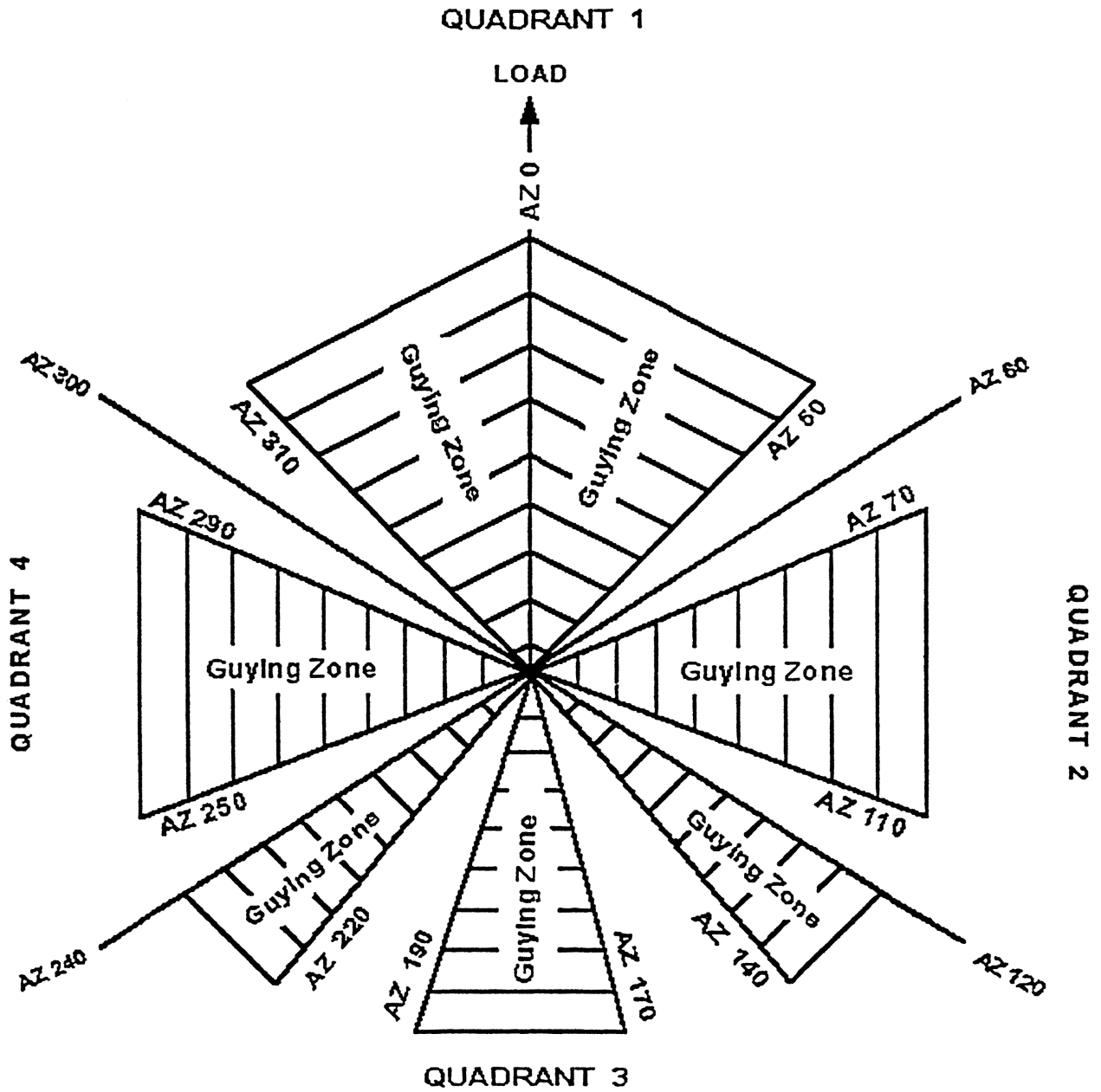

Figure 13: 7 Guyline Case

8 GUYLINE CASE

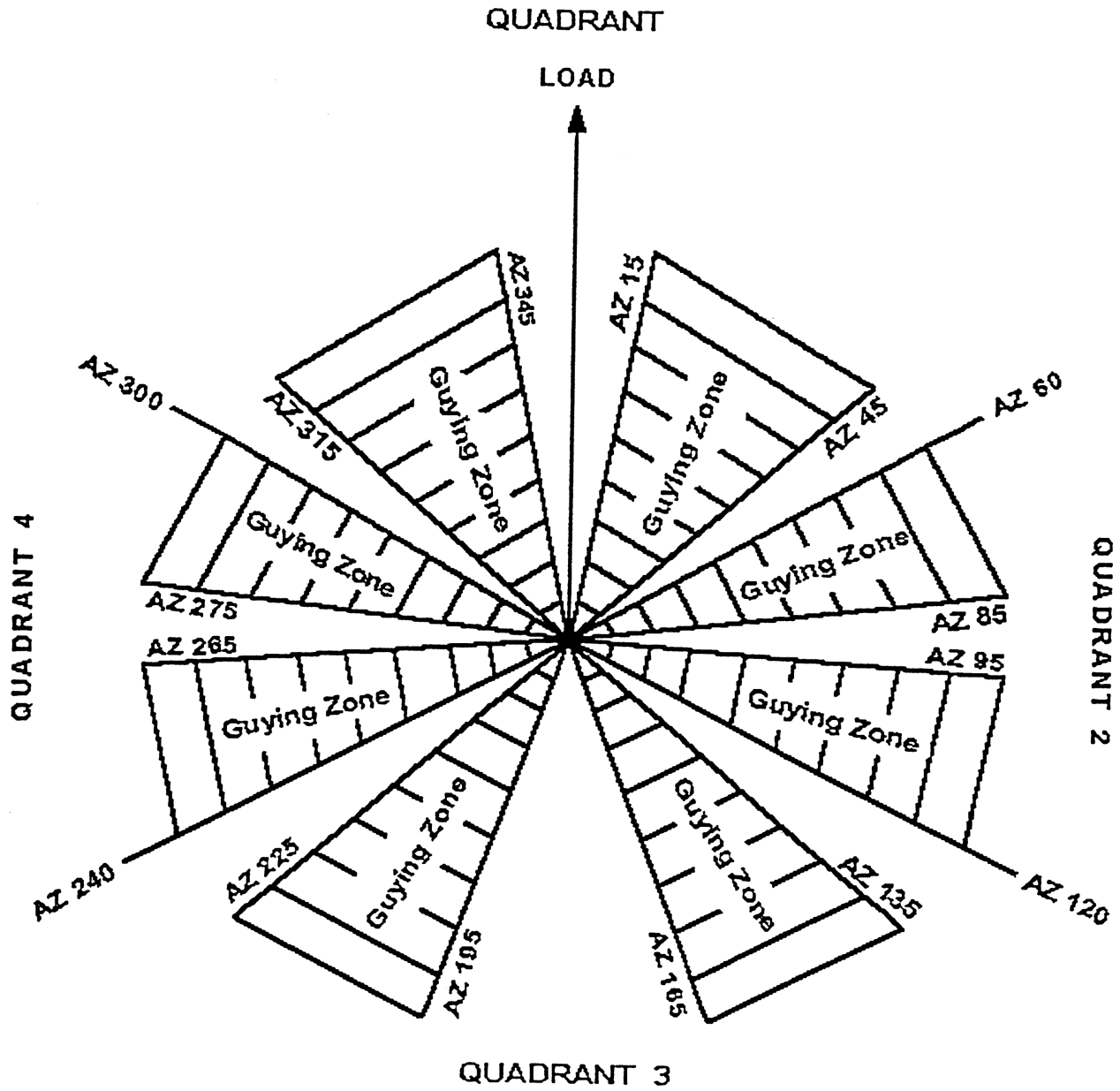

Figure 14: 8 Guyline Case

8 GUYLINE CASE

QUADRANT 1

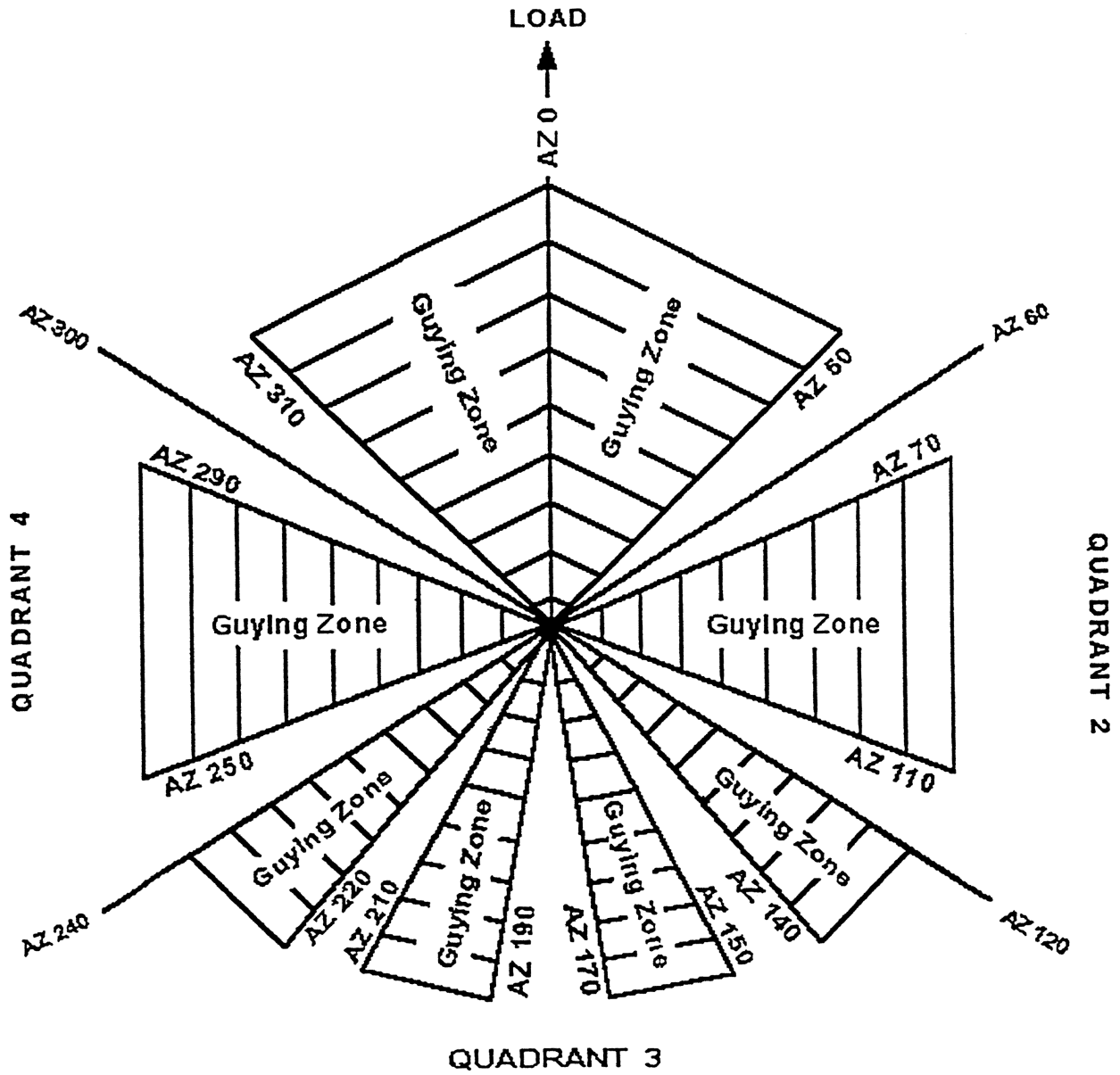

Figure 15: 8 Guyline Case (2)

POSITIONING GUYLINES IN BACK OF TREE

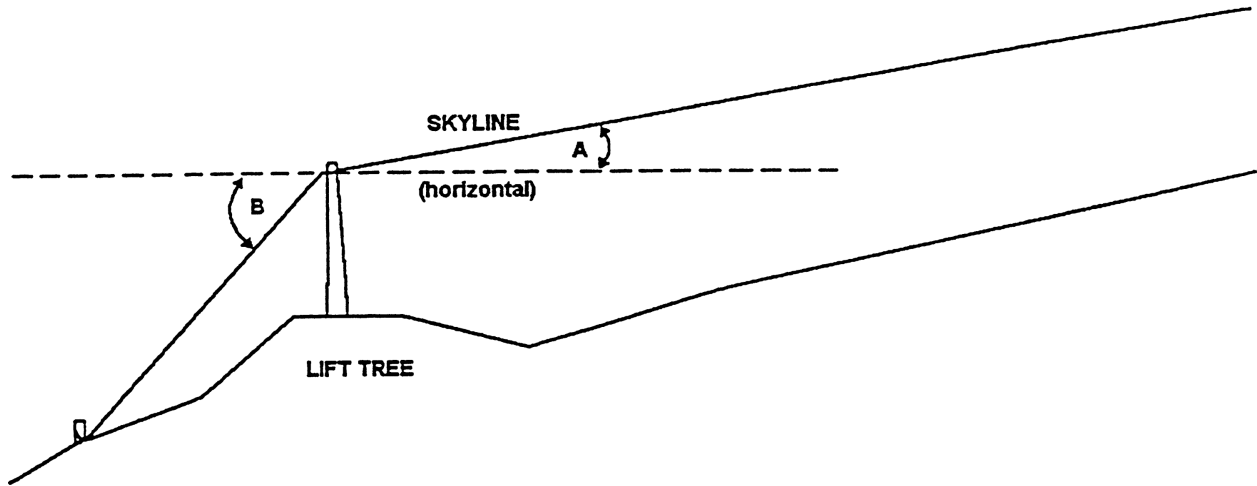

Figure 16: Positioning Guylines in Back of Tree

POSITIONING GUYLINES IN FRONT OF TREE

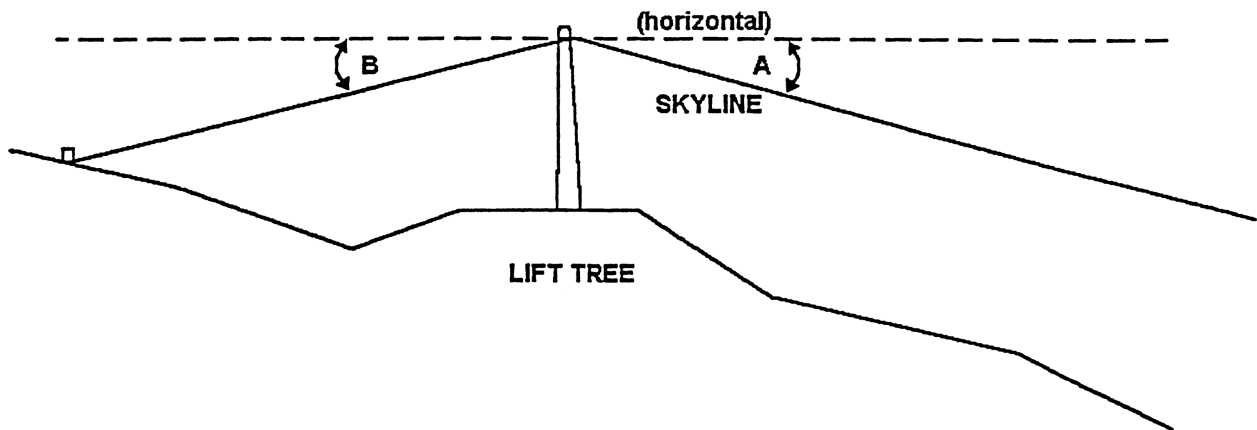

Figure 17: Positioning Guylines in Front of Tree

MAXIMUM ANGLE FOR LOAD BEARING GUYLINES AND SKYLINE

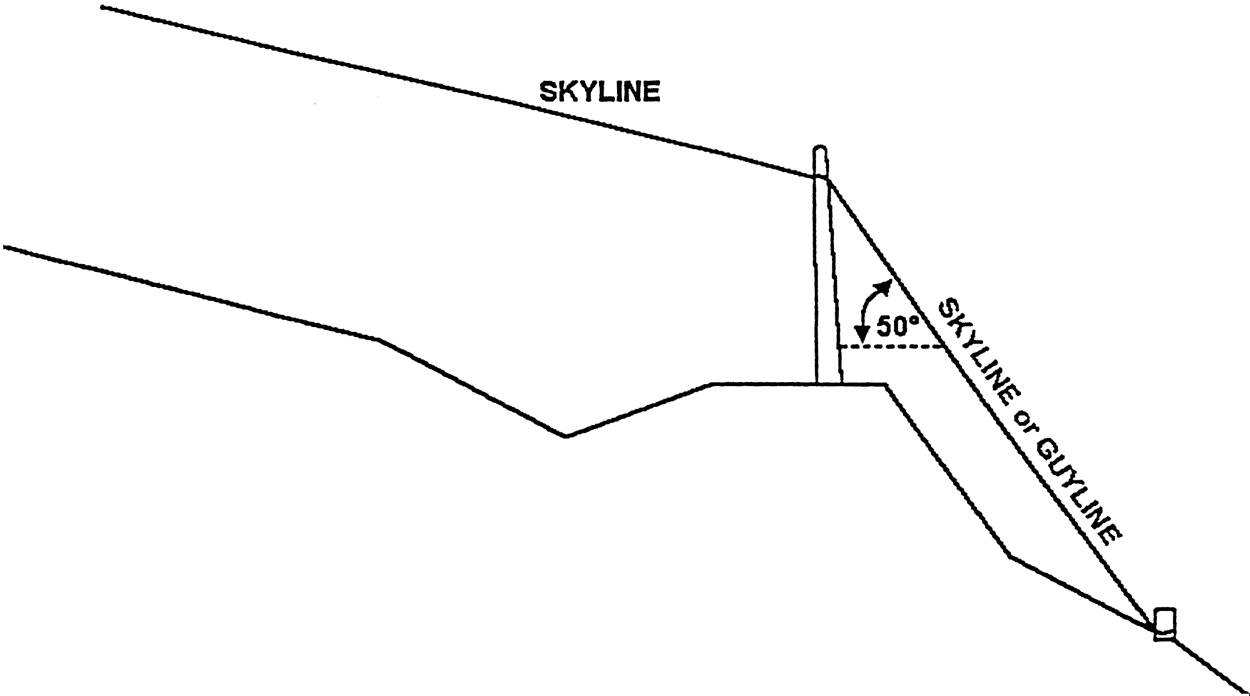

Figure 18: Maximum Angle for Load Bearing Guylines and Skyline

4 GUYLINE CASE – TAIL/LIFT TREE GUYING

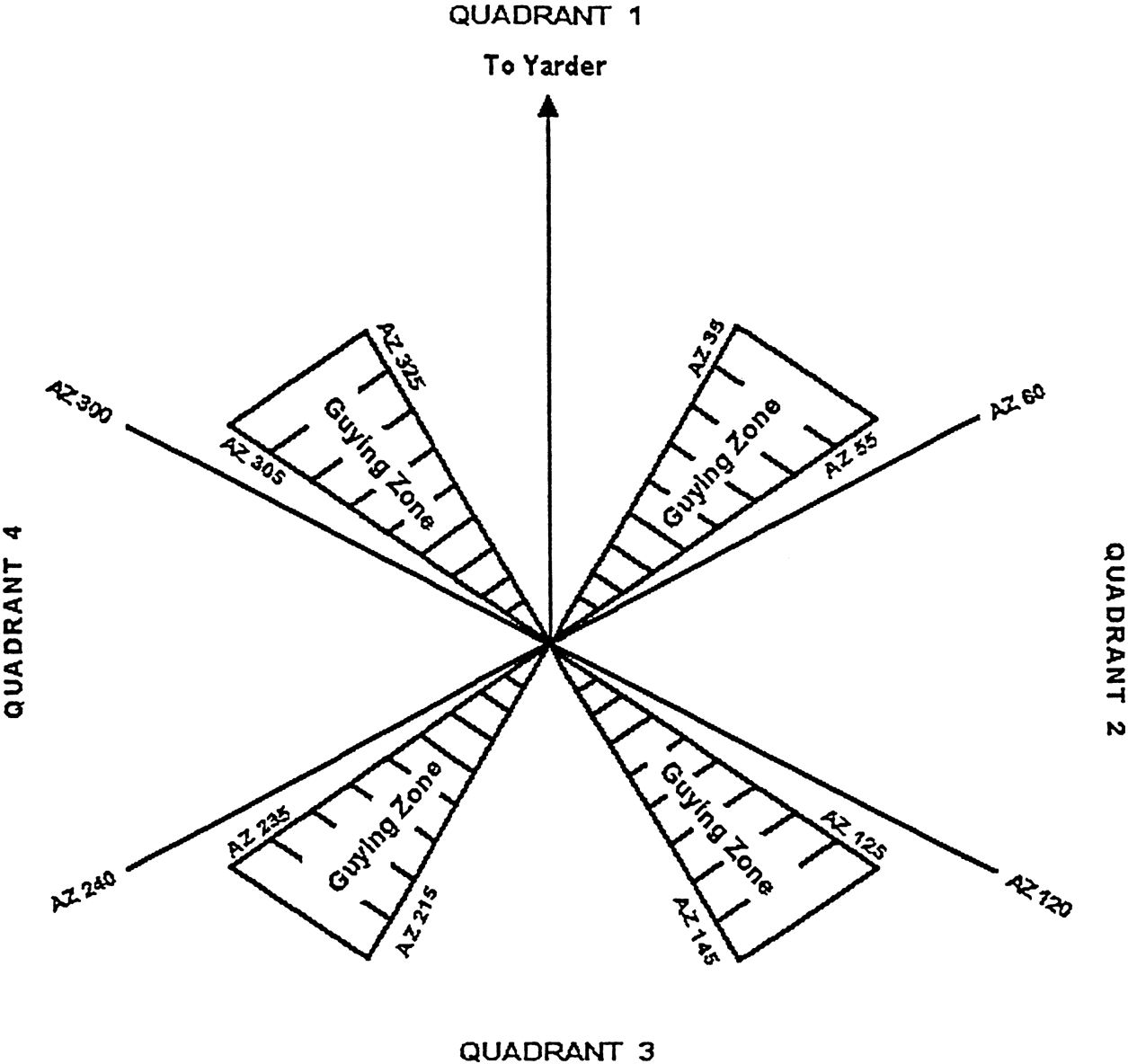

Figure 19: 4 Guyline Case - Tail/Lift Tree Guying

**2 GUYLINE CASE
TAIL/LIFT TREE GUYING**

(gravity outhaul, non-slackpulling carriage)

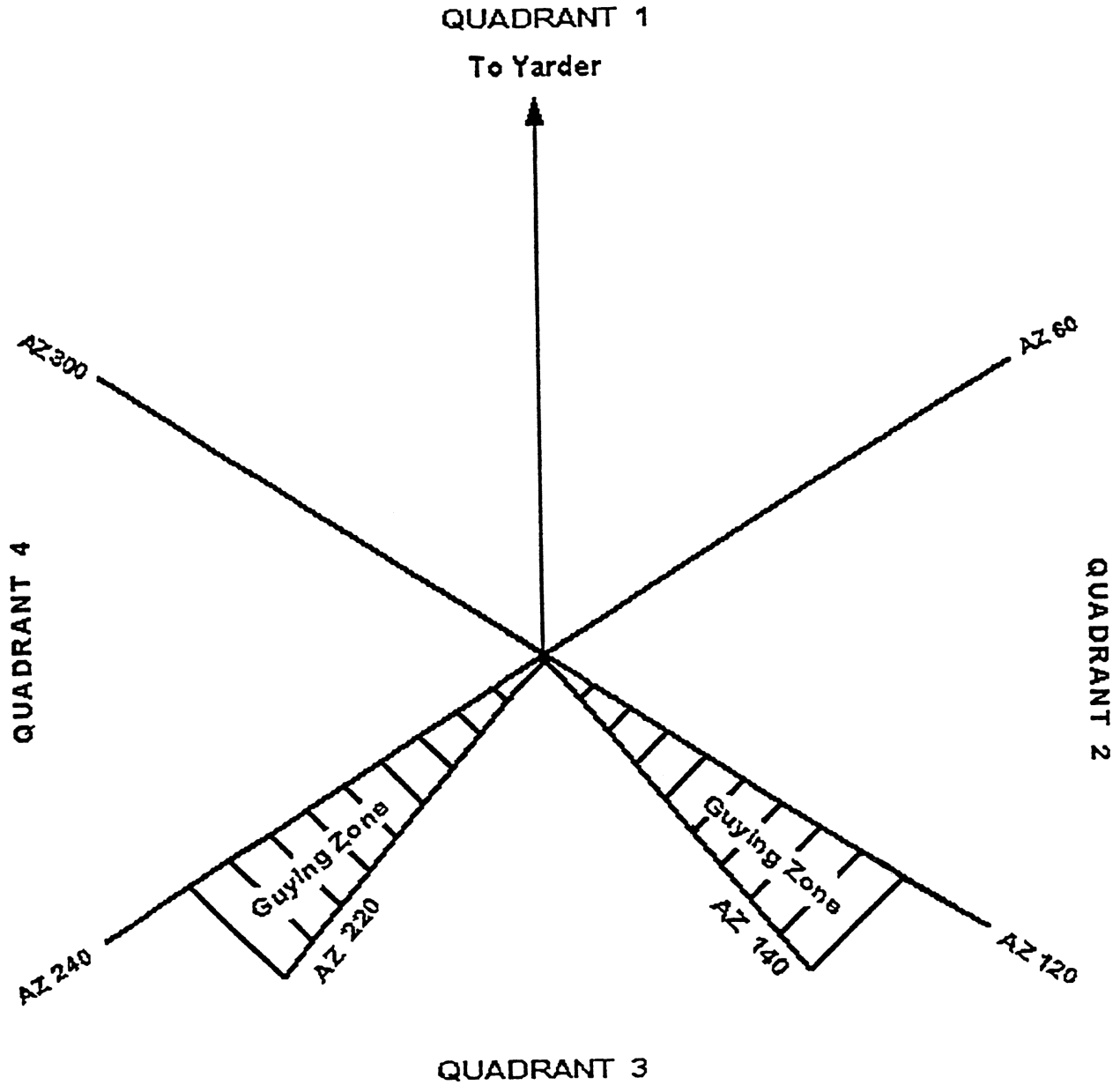

Figure 20: 2 Guyline Case - Tail/Lift Tree Gying
(gravity outhaul, nonslackpulling carriage)

[Statutory Authority: RCW 49.17.010, 49.17.040, 49.17.050, 49.17.060, and chapter 49.17 RCW. WSR 17-17-131, § 296-54-561, filed 8/22/17, effective 10/22/17. Statutory Authority: RCW 49.17.010, [49.17].040 and [49.17].050. WSR 99-17-117, § 296-54-561, filed 8/18/99, effective 12/1/99. Statutory Authority: RCW 49.17.040, [49.17].050 and [49.17].060. WSR 96-22-013, § 296-54-561, filed 10/28/96, effective

1/1/97. Statutory Authority: RCW 49.17.040, 49.17.150 and 49.17.240. WSR 79-10-081 (Order 79-14), § 296-54-561, filed 9/21/79.]

WAC 296-54-563 Guying tail/lift trees. (1) Whenever a tail/lift tree is within reach of the work area and the rigging is placed on the tail/lift tree at a height greater than five times the tree diameter (dbh), at least two guylines must be used unless tree size and strength and rigging position eliminate the need for guylines or employees must be in the clear before the go-ahead signal is given.

(2) Guylines on tail/lift trees must not be anchored to standing trees unless:

(a) There is no danger that the guyline anchor tree will enter the work area;

(b) The guyline anchor tree is properly tied back; or

(c) Employees are in the clear of the guyline anchor tree(s) before the go-ahead signal is given.

(3) When guylines are required, they must be positioned according to Figure 16: Positioning Guylines in Back of Tree and Figure 19: 4 Guyline Case - Tail/Lift Tree Guying as follows:

(a) When the angle between the horizontal and skyline coming into the tree (angle A in Figure 16) is less than the angle between the horizontal and the skyline leaving the tree towards the anchor point (angle B in Figure 16), the guylines must be in back of the tail/lift tree as specified in Figure 19.

(b) If angle A is greater than angle B, then the guys must be placed in front of the tail/lift tree. This situation usually occurs when a tail/lift tree is used during downhill yarding as shown above. Placing the guys on the uphill side only helps to pull the tail/lift tree over uphill.

(c) If a suitable anchor is not available within a specified shaded zone, two guylines may be used instead of one guyline, provided a guyline is placed on either side of and as near as possible to the affected shaded zone.

(4) Tail/lift trees must be supported by additional guylines if necessary, to ensure the stability of the tree.

(5) Guylines for tail/lift trees may be made of synthetic material and must be used according to the manufacturer's recommendation.

[Statutory Authority: RCW 49.17.010, 49.17.040, 49.17.050, 49.17.060, and chapter 49.17 RCW. WSR 17-17-131, § 296-54-563, filed 8/22/17, effective 10/22/17. Statutory Authority: RCW 49.17.010, [49.17].040 and [49.17].050. WSR 99-17-117, § 296-54-563, filed 8/18/99, effective 12/1/99. Statutory Authority: RCW 49.17.040, 49.17.050, 49.17.240, chapters 43.22 and 42.30 RCW. WSR 80-11-057 (Order 80-15), § 296-54-563, filed 8/20/80. Statutory Authority: RCW 49.17.040, 49.17.150 and 49.17.240. WSR 79-10-081 (Order 79-14), § 296-54-563, filed 9/21/79.]

WAC 296-54-565 Intermediate support trees. (1) Trees used as intermediate supports must be sound and straight from the ground to the point of strap attachment; and must be rigged so that:

(a) Carriage clearance, as measured at the base of the support tree(s) is approximately five feet.

(b) The jackline/support line (see Figure 21: Critical Measurements of the Double Tree Intermediate Support System) is a single

piece of line that is one-eighth inch larger than the tong or skidding line or rigged to provide a strength equal to a line one-eighth inch larger than the tong or skidding line.

(2) Vertical support trees must be firmly rooted.

(3) The base of all leaning tree supports must be prevented from moving by:

(a) Retaining twenty percent of the stump diameter in holding wood; or

(b) Other suitable rigging arrangements.

(4) Double tree supports must be rigged so that (see Figure 22: Double Tree Intermediate Support System):

(a) The minimum and maximum heights of the jack relative to the height of the block are as shown below:

(b) The angle the block line makes with the center line of the support tree is as follows:

(i) For skylines one and one-eighth inch and smaller, ten degrees in any direction; and

(ii) For skylines larger than one and one-eighth inch, deflection of the block is in the direction of the jack and a maximum of ten degrees.

(c) The loaded support tree does not displace more than two feet at the point of rigging attachment.

(5) Intermediate support trees must be adequately guyed to withstand any stress to which the tree may be subjected.

(6) Single tree supports must be guyed as follows:

(a) For skylines one and one-eighth inch and less, as shown in Figure 4; and

(b) For skylines larger than one and one-eighth inch, as shown in Figure 6.

(7) Double tree supports must be guyed as follows:

(a) For skylines one and one-eighth inch and less, no guys are required;

(b) For skylines larger than one and one-eighth inch, as shown in Figure 4.

(8) Guylines for intermediate support trees may be made of synthetic material and must be used according to the manufacturer's recommendations.

CRITICAL MEASUREMENTS OF THE DOUBLE TREE INTERMEDIATE SUPPORT SYSTEM

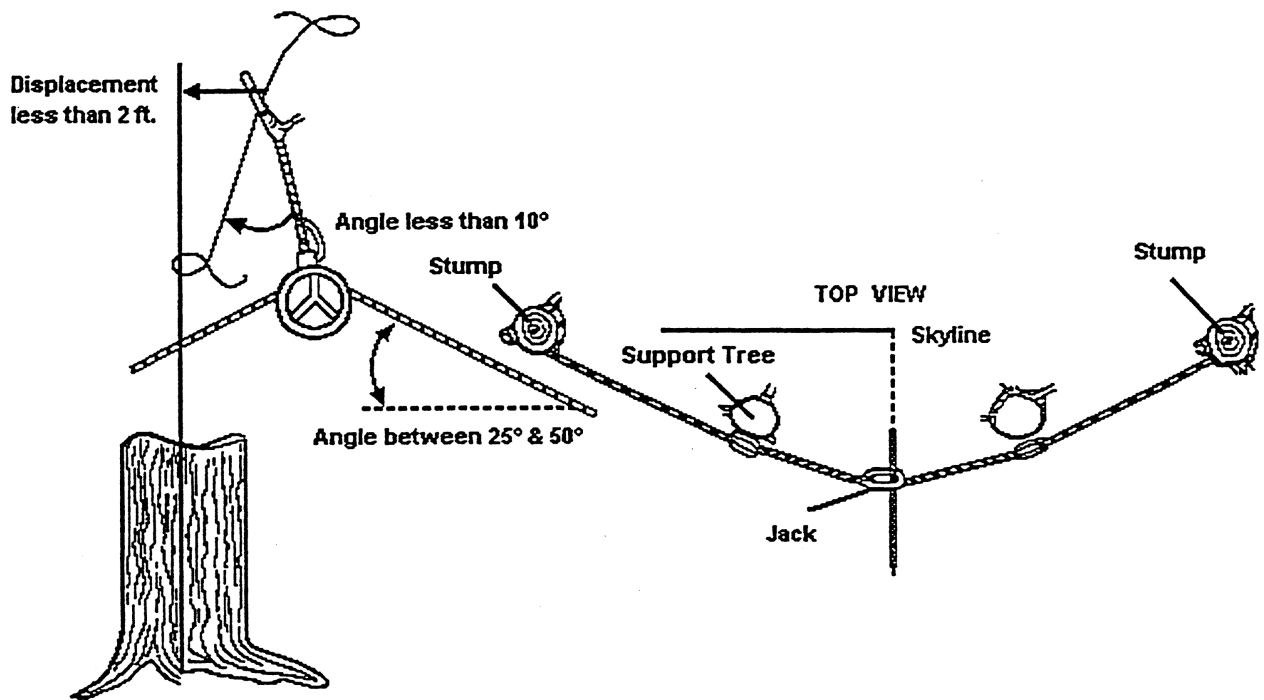
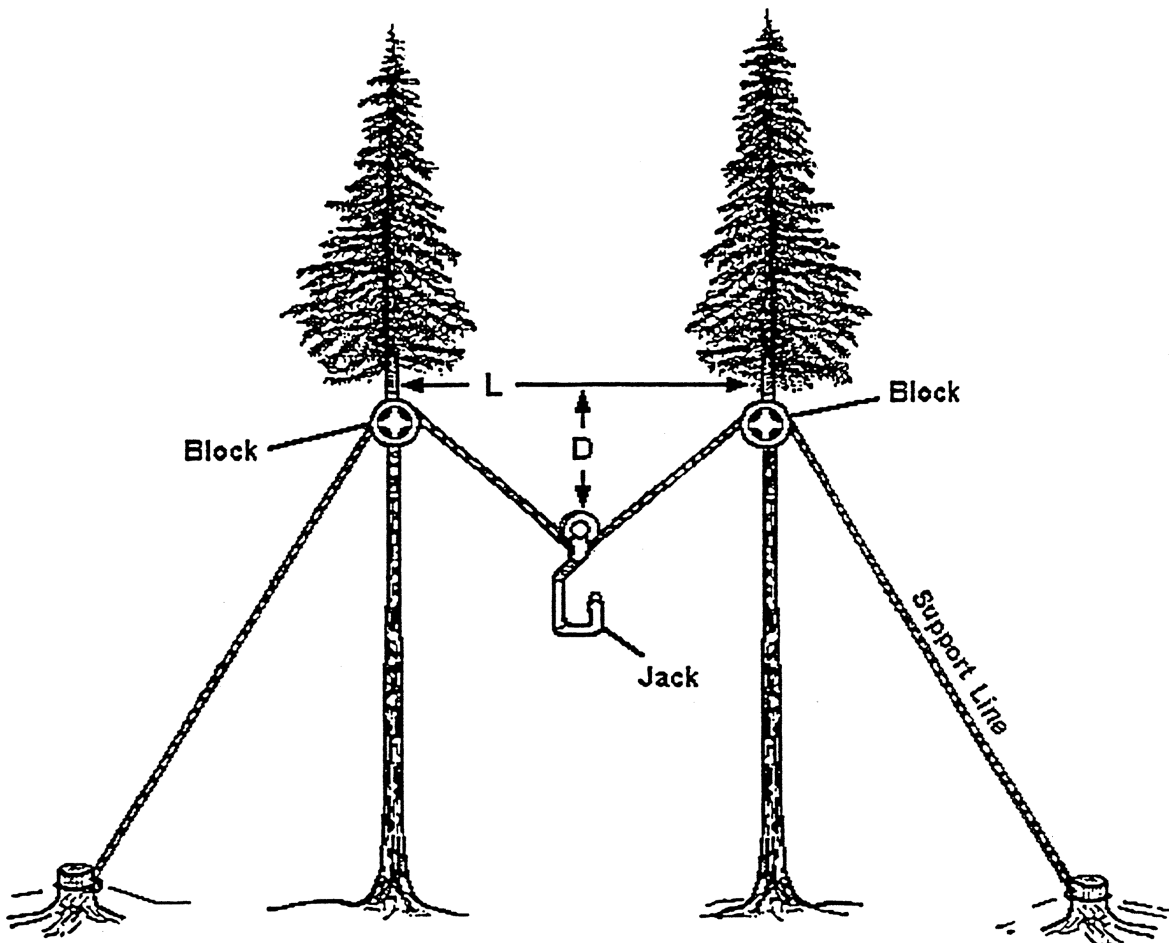

Figure 21: Critical Measurements of the Double Tree Intermediate Support System

DOUBLE TREE INTERMEDIATE SUPPORT SYSTEM



Front View

D = .25 X L = minimum distance

D = .5 X L = maximum distance

Figure 22: Double Tree Intermediate Support System

[Statutory Authority: RCW 49.17.010, [49.17].040 and [49.17].050. WSR 99-17-117, § 296-54-565, filed 8/18/99, effective 12/1/99. Statutory Authority: RCW 49.17.040, [49.17].050 and [49.17].060. WSR 96-22-013, § 296-54-565, filed 10/28/96, effective 1/1/97. Statutory Authority: RCW 49.17.040, 49.17.150 and 49.17.240. WSR 79-10-081 (Order 79-14), § 296-54-565, filed 9/21/79.]

WAC 296-54-567 Rigging skylines. (1) A skyline must not make an angle greater than fifty degrees measured from the horizontal as it leaves the tail/lift tree. (See Figure 18: Maximum Angle for Load Bearing Guylines and Skyline.)

(2) When rigged in a tail/lift tree, the skyline must be anchored no more than eight degrees offline from the rearward projection of the skyline. If a suitable anchor is not available within the specified zone and the tail/lift tree is stable, a more suitable anchor outside the zone may be used. (See Figure 23: Skyline Positioning Limits Tail/Lift Tree.)

(3) A skyline must not be considered a guyline.

(4) Extensions to skylines must be equal in breaking strength to the skyline to which they are attached and must not alter the safe capacity of the tower. In addition, the extension must be attached only by a regular long splice or by a flush pin straight side shackle connecting the two eyes.

Note: See exception in WAC 296-54-553 (4)(e).

(5) Live, running or standing skylines must be anchored by one of the following methods:

(a) Directly to a stump or suitable manufactured anchor;

(b) Directly to the base of a standing tree provided the point of attachment is no more than three feet above the ground and no part of the tree will enter the work area if pulled over;

(i) If the tree will enter a work area, it must be properly tied back; or

(ii) Employee(s) must be in the clear before the go-ahead signal is given.

(c) By passing the skyline through a jack or block hung on a tail/lift tree before being anchored.

(6) Skylines or mainlines must be secured by one of the following methods:

(a) With at least two and one-half wraps, well spiked, or properly clamped (see WAC 296-54-569 (5)(b)); or

(b) Choked by using an approved shackle over the skyline or mainline with the pin through the eye and hung in a manner to prevent excessive bight or fouling when tightened; or

(c) With an approved strap having both eyes hung in a shackle and the knockout pin or safety pin through the eye of the skyline or mainline.

(7) Attaching the end of the skyline or slackline to the base of the rigged tail/lift tree is prohibited.

SKYLINE POSITIONING LIMITS TAIL/LIFT TREE

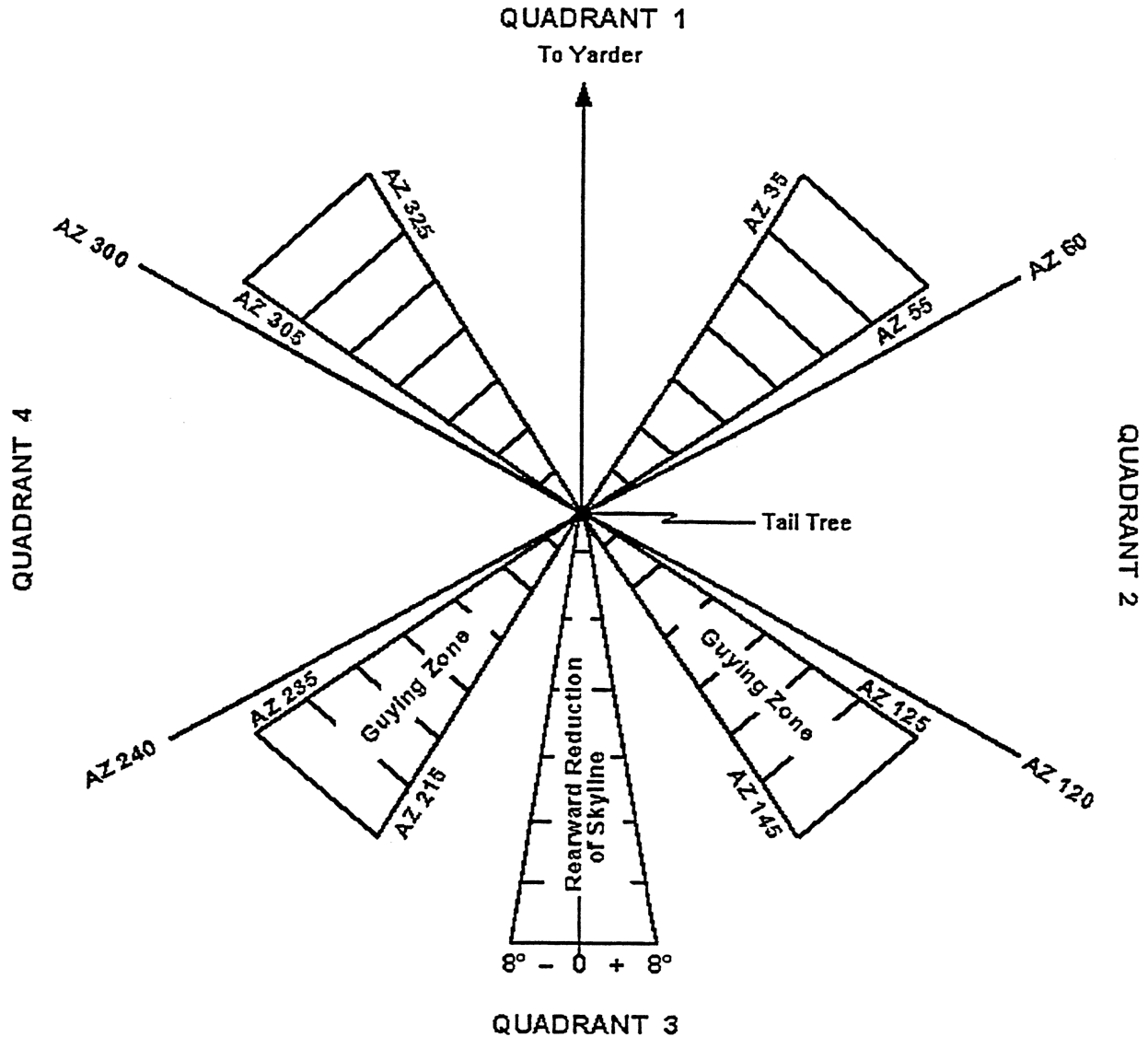

Figure 23: Skyline Positioning Limits Tail/Lift Tree

[Statutory Authority: RCW 49.17.010, 49.17.040, 49.17.050, 49.17.060, and chapter 49.17 RCW. WSR 17-17-131, § 296-54-567, filed 8/22/17, effective 10/22/17. Statutory Authority: RCW 49.17.010, [49.17].040 and [49.17].050. WSR 99-17-117, § 296-54-567, filed 8/18/99, effective 12/1/99. Statutory Authority: RCW 49.17.040, [49.17].050 and [49.17].060. WSR 96-22-013, § 296-54-567, filed 10/28/96, effective 1/1/97. Statutory Authority: RCW 49.17.040 and 49.17.050. WSR 81-05-013 (Order 81-3), § 296-54-567, filed 2/10/81. Statutory Authority: RCW 49.17.040, 49.17.150 and 49.17.240. WSR 79-10-081 (Order 79-14), § 296-54-567, filed 9/21/79.]

WAC 296-54-569 Anchoring. (1) Stumps used to anchor guylines and skylines must be carefully chosen for position, height, and strength. When necessary, stump anchors must be tied back to distribute the load.

(2) Stump anchors, when spiked, must be barked where attachments are to be made.

(3) Stump anchors must be adequately notched to keep the line in place and not adversely affect the stump strength.

(4) Employees must not stand close to the stump or tree or in the bight of lines as the guyline or wraps are being tightened.

(5) When spikes or cable clamps are used, guylines or skylines must be anchored with at least two and one-half wraps around the stumps. Wraps must:

(a) Be well secured with at least eight spikes or six staples in sound wood on the first and last wrap; or

(b) Have the end of the line secured with two wire rope clips on lines up to one inch diameter and three wire rope clips on lines one inch diameter and over.

(6) Properly installed deadman anchors are permitted. Guylines must not be directly attached to deadman anchors. Suitable straps or equally effective means must be used.

(7) When a standing tree is used as an anchor for guylines of portable spars, wood spars or towers:

(a) The tree must be properly tied back if it is within reach of a work area, landing area or haul road;

(b) The tree must be carefully chosen for strength;

(c) The line or strap must be attached to the base of the tree; and

(d) The tree must be adequately notched.

Note: The depth of the notch should not be any deeper than what is necessary to keep the line/strap from sliding up the tree.

(8) Rock bolt anchors must be grouted, installed, tested, and maintained according to the rock bolt manufacturer's recommendations.

(9) Anchors must be regularly inspected while the logging operation is in progress. Insecure or hazardous anchors must be corrected immediately.

(10) Artificial earth anchors must be installed and used according to their design specifications and manufacturer's recommendations.

(11) Mobile equipment may be used to anchor skylines, running lines and guylines, provided the weight of the machine or other methods are used to ensure machine stability for all applied loads.

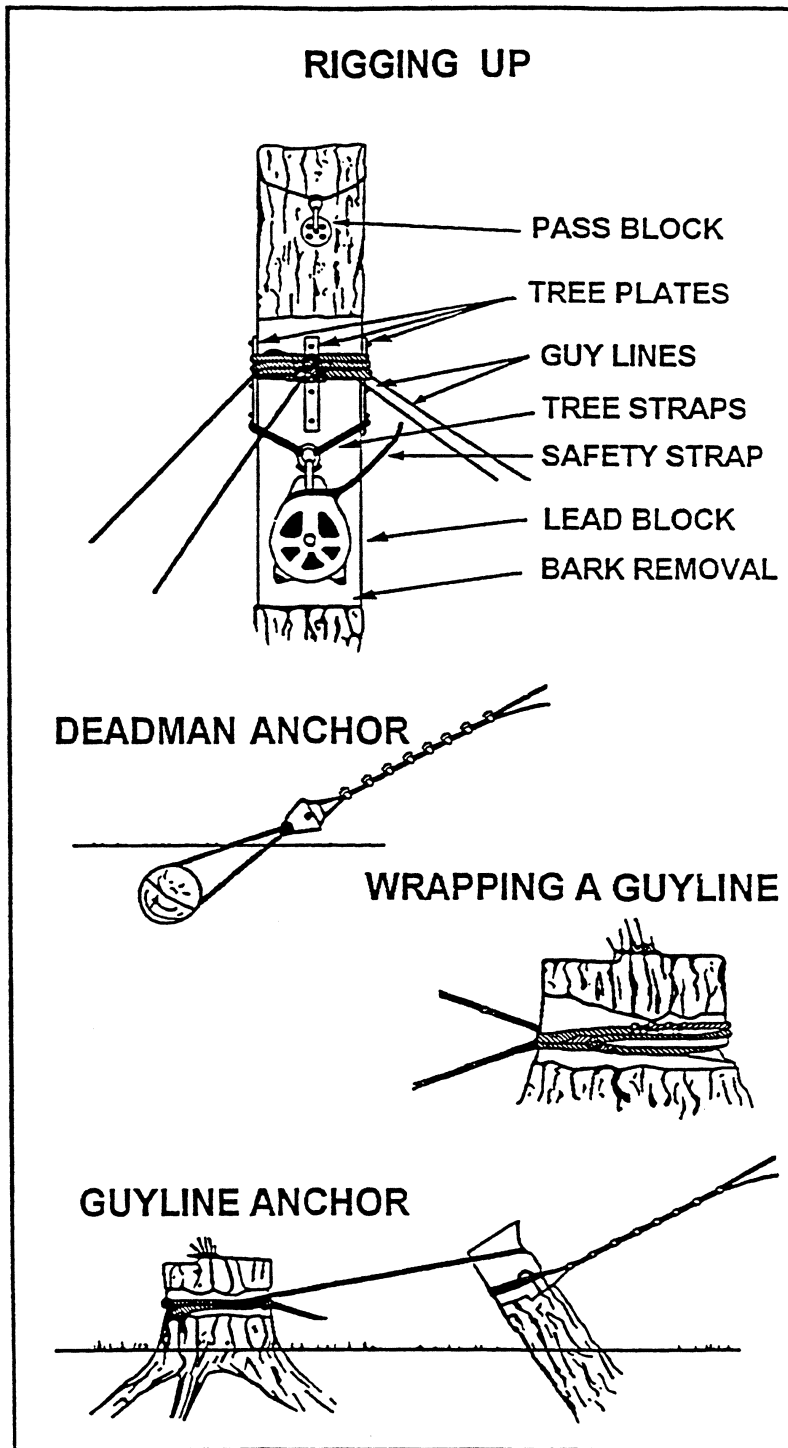

Figure 24: Rigging Illustrations

[Statutory Authority: RCW 49.17.010, 49.17.040, 49.17.050, 49.17.060, and chapter 49.17 RCW. WSR 17-17-131, § 296-54-569, filed 8/22/17, effective 10/22/17. Statutory Authority: RCW 49.17.010, [49.17].040 and [49.17].050. WSR 99-17-117, § 296-54-569, filed 8/18/99, effective 12/1/99. Statutory Authority: Chapter 49.17 RCW. WSR 90-09-026 (Order 90-01), § 296-54-569, filed 4/10/90, effective 5/25/90. Statutory Authority: RCW 49.17.040, 49.17.150 and 49.17.240. WSR 79-10-081 (Order 79-14), § 296-54-569, filed 9/21/79.]

WAC 296-54-571 Releasing spiked guylines and spiked skylines from anchors. The following procedures must be followed when removing spiked guylines or spiked skylines from stumps:

- (1) Reversed safety wrap is put on and secured before loosening the last wrap;
- (2) An authorized employee is in charge of loosening guylines or skylines;
- (3) The authorized employee uses all precautions and gives warning before releasing lines; and
- (4) Safety holdbacks are used when necessary for employee safety.

[Statutory Authority: RCW 49.17.010, [49.17].040 and [49.17].050. WSR 99-17-117, § 296-54-571, filed 8/18/99, effective 12/1/99. Statutory Authority: RCW 49.17.040, 49.17.150 and 49.17.240. WSR 79-10-081 (Order 79-14), § 296-54-571, filed 9/21/79.]

WAC 296-54-573 Logging machines—General. (1) All logging machinery must have speed limiting devices, safety stops, or emergency shut down devices or shut off valves, with the controls located so that in the event of an emergency, the prime mover may be shut down from a safe place.

(2) The floor and lower portion of cabs must be completely enclosed with solid material, except at entrances, to prevent the operator from being injured by obstacles which otherwise could enter the cab compartment.

(3) Machine operators must be experienced in operating the equipment they use.

EXCEPTION: Inexperienced employees may operate equipment to gain experience while in training but may do so only while working under the immediate supervision of an experienced authorized person.

(4) All machine controls must be marked as to their purpose in the operation of the machine.

(5) The rated capacity of any vehicle transporting a machine must not be exceeded.

(6) Machines must be loaded, secured, and unloaded in a manner that will not create a hazard for any employee.

Note: This requirement includes the loading, securing and unloading of a machine on and off a transport vehicle.

(7) You must not make any modifications or additions that affect the capacity or safe operation of the equipment without written approval of the manufacturer or a qualified engineer. If modifications or changes are made, the capacity, operation and maintenance instruction plates, tags, or decals, must be changed accordingly. The original safety factor of the equipment must never be reduced.

(8) Equipment must be classed and used according to the manufacturer's rating. Where low gear ratios or other devices are installed to increase the line pull in accordance with subsection (7) of this section, the size of the rigging must be increased accordingly so that it will safely withstand the increased strains.

(9) Each machine, including any machine provided by an employee, must be maintained in serviceable condition and the following:

(a) Each machine must be inspected before initial use during each workshift. Defects or damage must be repaired or the unserviceable machine is replaced before beginning work.

(b) Operating and maintenance instructions must be available on the machine or in the area where the machine is being operated. Each

machine operator and maintenance employee must comply with the operating and maintenance instructions.

(c) Each machine must be operated only from the operator's station or as otherwise recommended by the manufacturer.

(d) Employees must not be allowed to ride on any load.

(10) Horns and travel alarms, which are part of the machine's original equipment, must be maintained in serviceable condition.

(11) The yarding machine or vehicle, including its load, must be operated with safe clearance from all obstructions.

(12) While manual/mechanized falling is in progress, all logging machines must be operated at least two tree lengths away from trees being fell.

EXCEPTION: This provision does not apply to logging machines performing tree pulling operations or logging machines called upon by the cutter to ground hazard trees. All cutters must be notified of the logging machine entrance into the area and all falling within two tree lengths of the logging machine must stop.

(13) If a hydraulic or pneumatic storage device can move the moving elements such as, but not limited to, blades, buckets, saws and shears, after the machine is shut down, the pressure or stored energy from the element must be discharged as specified by the manufacturer.

(14) Loads must not exceed the rated capacity of the pallet, trailer, or other carrier.

(15) Boom-type logging machines must have a boom stop to prevent over-topping of the boom.

(16) Boom points of timber booms must be equipped with metal straps, plates, or other devices as needed to properly secure eyebolts and fittings used to support lines, blocks, or other rigging.

(17) Logging machine sleds or bases must be strong enough to withstand any stresses imposed upon them.

(18) Stationary logging machines must be securely anchored or otherwise stabilized to prevent unintended movement while yarding or skidding.

(19) Logging machines and their components must be securely anchored to their bases.

(20) Logging machines must be kept free of flammable waste materials and any materials that might contribute to slipping, tripping or falling.

(21) A safe and adequate means of access and egress to all parts of logging machinery where persons must go must be provided and maintained in a safe and uncluttered condition. Machine access systems, meeting the specifications of the Society of Automotive Engineers, SAE J185, June 1988, "Recommended Practice for Access Systems for Off-Road Machines," must be provided for each machine where the operator or any other employee must climb onto the machine to enter the cab or to perform maintenance. Walking and working surfaces of each machine and machine work station must have a slip-resistant surface to assure safe footing.

(22) Enclosed-type cabs installed on mobile logging machines must have two means of exit. One may be an emergency exit and be available for use at all times regardless of the position of the side arms or other movable parts of the machine. An easily removable window is acceptable as the emergency exit if it is large enough for an employee to readily exit.

EXCEPTION: Cable yarders manufactured before July 1, 1980 are not required to have two means of exit.

(23) Before leaving the operator's station of a machine, the operator must ensure the machine is secured as follows:

(a) The parking brake or brake locks must be applied;

(b) The transmission must be placed in the manufacturer's specified park position; and

(c) Each moving element such as, but not limited to, blades, buckets, saws and shears, must be lowered to the ground or otherwise secured.

(24) Storing employee property, tools, or other miscellaneous materials on or within three feet of any logging machine is prohibited if retrieving the items would expose an employee to the hazardous pinch point area between the rotating superstructure and the nonrotating undercarriage.

(25) Employees must approach the hazardous pinch point area only after informing the operator of that intent and receiving acknowledgment from the operator that the operator understands the employee's intention. All logging machines must be stopped while any employee is in the hazardous pinch point area.

(26) After adjustments or repairs are made, logging machines must not be operated until all guards are reinstalled, safety devices reactivated, and maintenance equipment removed.

(27) Fairleads must be properly aligned at all times and designed to prevent line damage.

(28) Employee(s) must not ride on any mobile logging machine unless provided with seating, seat belts, and other protection equivalent to that provided for the operator.

EXEMPTION: Mechanics in the course of their job and trainees, operating under circumstances that minimize their exposure to dangerous situations, are exempt from this requirement.

(29) Riding on arches, reaches or turn of logs is prohibited.

(30) Tractors, skidders, arches, or logs being yarded by them must not run over or rub against anchored lines, tailhold stumps, or other rigging.

(31) Ends of lines attached to drums on logging machines must be secured by end attachments that develop the ultimate strength of the line unless three wraps of line are maintained on the drum at all times.

EXCEPTION: This does not apply to tractors or skidders.

(32) Wire rope must be wound on drum spools in a manner to prevent excessive wear, kinking, chafing or fouling.

(33) Guylines required in rigging spars or towers must be evenly spooled to prevent fouling.

(34) A guide pulley, tool, stick, iron bar or other mechanical or manual means must be used when guiding lines onto drums. Guiding lines onto drums with any part of the body in direct contact with the line is prohibited.

(35) A limit switch must be installed on electric-powered log loaders to prevent the lift arms from traveling too far in the event the control switch is not released in time.

(36) All forklift type log handling machines must be equipped with a grapple system and the arms must be closed whenever logs are being carried.

(37) When forklift machines are used to load, unload, or handle trailers, a positive means of holding the lifting attachment on the fork must be installed and used.

(38) Loads on forklift type log handling machines must be transported as low as safely operable without obstructing visibility.

(39) Guyline drum controls and outrigger controls must be separated and clearly identified in a manner that will prevent the engaging of the wrong control.

(40) Each machine must be equipped with guarding to protect employees from exposed moving elements, such as, but not limited to, shafts, belts, pulleys on chains, sprockets and gears in accordance with the requirements of this standard and chapter 296-806 WAC, Machine safety. Guards must be in place at all times when machines are in use.

Note: This does not apply to lifting or yarding components such as, but not limited to, cable nip points, sheaves and blocks.

(41) Each machine used for debarking, limbing, and chipping must be guarded to protect employees from flying wood chunks, logs, chips, bark, limbs, and other material in accordance with the requirements of this standard and chapter 296-806 WAC, Machine safety.

(42) Grab rails must be provided and maintained in good repair on all walkways of stationary units elevated more than four feet.

(43) Towed equipment such as, but not limited to, skid pans, pallets, arches, and trailers, must be attached to each machine or vehicle to allow a full ninety degree turn; to prevent overrunning of the towing machine or vehicles; and to ensure that the operator is always in control of the towed equipment.

(44) Timbers used for masts or booms must be straight-grained, solid, and capable of withstanding the working load.

[Statutory Authority: RCW 49.17.010, 49.17.040, 49.17.050, 49.17.060, and chapter 49.17 RCW. WSR 17-17-131, § 296-54-573, filed 8/22/17, effective 10/22/17. Statutory Authority: RCW 49.17.010, 49.17.040, 49.17.050, 49.17.060. WSR 06-07-142, § 296-54-573, filed 3/21/06, effective 5/1/06; WSR 04-14-028, § 296-54-573, filed 6/29/04, effective 1/1/05. Statutory Authority: RCW 49.17.010, [49.17].040 and [49.17].050. WSR 99-17-117, § 296-54-573, filed 8/18/99, effective 12/1/99. Statutory Authority: RCW 49.17.040, 49.17.150 and 49.17.240. WSR 79-10-081 (Order 79-14), § 296-54-573, filed 9/21/79.]

WAC 296-54-57310 Logging machines—Chipping in woods locations.

In-woods chipping must be performed according to the following:

(1) Chipper access covers or doors remain closed until the drum or disc stops completely.

(2) Infeed and discharge ports are guarded to prevent contact with the disc, knives, or blower blades.

(3) The chipper is shut down and locked out according to the lockout/tagout requirements of chapter 296-803 WAC when an employee performs any servicing or maintenance.

(4) Detached trailer chippers are chocked when used on any slope where rolling or sliding of the chipper is reasonably foreseeable.

[Statutory Authority: RCW 49.17.010, 49.17.040, 49.17.050, and 49.17.060. WSR 04-15-105, § 296-54-57310, filed 7/20/04, effective 11/1/04. Statutory Authority: RCW 49.17.010, [49.17].040 and [49.17].050. WSR 99-17-117, § 296-54-57310, filed 8/18/99, effective 12/1/99.]

WAC 296-54-57315 Logging machines—Exhaust pipes.

(1) Engines not equipped with turbochargers must be equipped with spark arrestors in compliance with the department of natural resources, chapter 332-24 WAC, requirements for spark-emitting equipment.

(2) Each machine muffler provided by the manufacturer, or their equivalent, must be in place at all times the machine is in operation.

(3) Exhaust pipes must be located or insulated to protect workers from accidental contact with the pipes or muffler and must direct exhaust gases away from the operator and other persons.

[Statutory Authority: RCW 49.17.010, [49.17].040 and [49.17].050. WSR 99-17-117, § 296-54-57315, filed 8/18/99, effective 12/1/99.]

WAC 296-54-57320 Logging machines—Glass. Glass installed on logging machines must:

(1) Be free of deposits of oil and mud or defects that could endanger the operator or other employees;

(2) Be safety glass or a type that provides equal protection;

(3) Be removed or replaced if defective or broken glass impairs the vision of the operator; and

(4) Have an additional metal screen or guard installed where glass does not provide adequate operator protection from flying chokers, chunks, saplings, limbs, etc. The operator's vision must not be impaired.

[Statutory Authority: RCW 49.17.010, [49.17].040 and [49.17].050. WSR 99-17-117, § 296-54-57320, filed 8/18/99, effective 12/1/99.]

WAC 296-54-57325 Logging machines—Brakes. (1) Brakes or dogs must be installed on all machine drums and maintained in effective working condition.

(2) Drum brakes must have an independent locking device that will hold the drum when the operator leaves the machine and the machine is not operating.

(3) Brakes must be protected from direct exposure to the elements or be designed or constructed to make them impervious to such exposure.

(4) At the start of each shift, logging machine operators must test all brakes before taking a load.

(5) Service brakes must be able to stop and hold each machine and its rated load capacity on the slopes over which it is being operated. Brakes must be effective whether or not the engine is running and regardless of the direction of travel.

(6) Self-propelled logging machines manufactured on or after July 1, 1985, must be equipped with braking systems as follows:

(a) A service braking system, which must be the primary means of stopping and holding the equipment;

(b) An emergency stopping system, which must be a secondary means of stopping the equipment in the event of any single failure of the service system; and

(c) A parking brake system, which must be used to continuously hold a stopped machine stationary within the limits of traction on any grade on which it is operated so as to allow the operator to leave the vehicle without the vehicle moving, and to prevent subsequent movement of the vehicle while unattended. The parking brake system must maintain this parking performance despite any contraction of brake parts, failure of the source of application, energy or leakage of any kind.

(7) The braking systems required in subsection (5) of this section must be installed, tested, and maintained according to the following Society of Automotive Engineers' (SAE) Recommended Practices:

(a) J1026-1982—Braking Performance—In Service Crawler Tractors and Crawler Loaders;

(b) J1473-1984—Braking Performance—Rubber-Tired Construction Machines;

(c) J1178-1980—Minimum Performance Criteria for Braking Systems for Rubber-Tired Skidders.

(8) Self-propelled logging machines manufactured before July 1, 1985, must have braking systems installed, tested and maintained in as effective a condition as originally intended by the manufacturer.

[Statutory Authority: RCW 49.17.010, [49.17].040 and [49.17].050. WSR 99-17-117, § 296-54-57325, filed 8/18/99, effective 12/1/99.]

WAC 296-54-57330 Logging machines—Outriggers. (1) All outriggers must have a stable base under the outrigger or equivalent leveling pads as recommended by the equipment manufacturer.

(2) Outriggers must have a means to hold them in both the retracted and extended position.

(3) Hydraulic outriggers must have a positive holding device (velocity fuse, load check valve, manually operated valve or equivalent) to prevent movement of the piston in the event of a hose, fitting or other failure in the hydraulic system except when proper blocking is provided.

[Statutory Authority: RCW 49.17.010, [49.17].040 and [49.17].050. WSR 99-17-117, § 296-54-57330, filed 8/18/99, effective 12/1/99.]

WAC 296-54-57335 Logging machines—Hydraulics. (1) If failure of hydraulic lines could create a hazard to an equipment operator while at the operator's station, safeguards must be installed that will eliminate the hazard.

(2) Machines or equipment must not be operated when hydraulic fluid leakage creates contamination of the operator's workstation, means of access or egress, or creates other unsafe conditions such as fire hazard or control malfunction.

(3) Abrasive contact with hydraulic hoses, tubing or fittings must be eliminated before further use.

(4) Defective hydraulic hoses, lines and fittings must be replaced.

[Statutory Authority: RCW 49.17.010, [49.17].040 and [49.17].050. WSR 99-17-117, § 296-54-57335, filed 8/18/99, effective 12/1/99.]

WAC 296-54-57340 Logging machines—A-frames. (1) A-frames must be guyed or braced to provide stability and prevent tipping.

(2) A-frame bases must be secured against displacement and the tops must be securely bolted or lashed to prevent displacement.

(3) Where guylines are used, A-frames must have at least one snap guy and two guylines securely attached, anchored and spread to form an

angle 70 degrees to 90 degrees opposite the direction of stress or strain.

[Statutory Authority: RCW 49.17.010, [49.17].040 and [49.17].050. WSR 99-17-117, § 296-54-57340, filed 8/18/99, effective 12/1/99.]

WAC 296-54-57345 Logging machines—Moving. (1) Operators must ensure that all employees are in the clear before initiating or continuing the movement of any mobile equipment. The machine must be operated far enough from employees and other machines so that operation does not create a hazard for an employee.

(2) At any time when moving logging machines, the driver must have a clear and unobstructed view of the direction of travel. When this is not possible, a signal person with a clear and unobstructed view of the direction of travel must be designated and used to direct the movement of the machine, or the machine must have an audible horn that is sounded.

EXCEPTION: This does not apply to tractors, skidders or tree harvesters during normal yarding operations.

(3) Where a signalperson is used, the equipment operator must move the equipment only on signal from the designated signalperson and only when the signal is distinct and clearly understood.

(4) When moving power units, persons other than the operator and the person in charge must not be permitted to ride on the unit.

(5) All obstructions that may reach the operator while moving a machine must be removed.

(6) When moving to areas within the immediate landing area, all employees must stay in the clear of the logging machine(s) or must inform the operator of the intent to approach or be near the machine(s).

(7) Mobile yarders and wheel or crawler loaders must not travel on road grades greater than 15 percent unless they are securely snubbed or towed, or have a braking system designed for such travel by the manufacturer.

(8) Crawler-type, track-mounted logging machines with manual transmissions must be equipped with a ratchet or other device that will prevent unintended disengagement or reversing of the machine and the operator must be informed of the proper technique.

[Statutory Authority: RCW 49.17.010, [49.17].040 and [49.17].050. WSR 99-17-117, § 296-54-57345, filed 8/18/99, effective 12/1/99.]

WAC 296-54-57350 Logging machines—Tractors and skidders. (1) Operators must operate and control their machines in a safe manner and avoid operations in areas where machine stability may not be maintained.

(2) Winch lines on logging tractors or skidders must be attached to the drums with a breakaway device.

(3) Arches must be equipped with line guards.

(4) A turnaround, if needed for skidders, must be provided on all skidding roads every 500 feet.

(5) The following safe work procedures must be followed:

(a) Lines must not be allowed to trail behind the tractor or skidder where it may hang up and snap forward.

(b) Each machine must be positioned during winching so the machine and winch are operated within their design limits.

(c) Logs/trees must be choked near the ends of the logs/trees whenever possible and safely positioned before traveling.

(d) Before climbing or descending grades, the proper gear must be selected to allow the engine to govern the tractor speed.

(e) On side hills, abrupt turns uphill must be avoided. The tractor or skidder must be backed downhill first then turned uphill. The turn may be slacked off as necessary to permit this maneuver.

(f) Tractor or skidder speed must be adjusted to the circumstances prevailing. Excessive or uncontrolled speed must be avoided.

(6) Where tractor and skidder operators or helpers, because of the nature of their work duties, are required to wear calk soled footwear, the decks and operating foot controls must be covered with a suitable nonslip material.

[Statutory Authority: RCW 49.17.010, 49.17.040, 49.17.050, 49.17.060, and chapter 49.17 RCW. WSR 17-17-131, § 296-54-57350, filed 8/22/17, effective 10/22/17. Statutory Authority: RCW 49.17.010, [49.17].040 and [49.17].050. WSR 99-17-117, § 296-54-57350, filed 8/18/99, effective 12/1/99.]

WAC 296-54-57355 Logging machines—Protective structures for operators. (1) Each tractor, skidder, log stacker and mechanical felling device, such as tree shears or feller-buncher, placed into initial service after February 9, 1995, must be equipped with falling object protective structure (FOPS) and/or rollover protective structure (ROPS). The employer must replace FOPS or ROPS which have been removed from any machine.

EXCEPTION: This requirement does not apply to machines which are capable of 360 degree rotation.

(2) ROPS must be installed, tested, and maintained in accordance with the Society of Automotive Engineers SAE J1040, April 1988, "Performance Criteria for Rollover Protective Structures (ROPS) for Construction, Earthmoving, Forestry, and Mining Machines."

(3) The ROPS must be high enough and wide enough so that it will not impair the movements of the operator or prevent his immediate escape from the vehicle in emergencies and must allow as much visibility as possible. Clearance above the deck and the ROPS of the vehicle at exits must be at least fifty-two inches (1.3 meters).

(4) Certified roll-over protective systems must be identified by a metal tag permanently attached to the ROPS in a position where it may be easily read from the ground. The tag must be permanently and clearly stamped, etched or embossed indicating the name and address of the certifying manufacturer or registered professional engineer, the ROPS model number (if any) and the vehicle make, model or serial number the ROPS is designed to fit.

(5) Roll-over protective structure systems must be maintained in a manner that will preserve their original strength. Welding must be performed by qualified welders only. (A qualified welder is defined under "welder qualification" in American Welding Society A.W.S. A3.0-69.)

(6) FOPS structures must be installed, tested and maintained according to:

(a) The society of automotive engineers SAE J231-1971, "minimum performance criteria for falling object protective structures (FOPS) prior to February 9, 1995."

(b) Society of automotive engineers SAE J231, January 1981, "minimum performance criteria for falling object protective structures (FOPS) for each tractor, skidder, log stacker, log loader and mechanical falling device, such as tree shears or faller-buncher, placed into initial service after February 9, 1995."

(7) You must replace FOPS that have been removed from any machine.

(8) Vehicles with ROPS or FOPS as required in subsection (1) of this section, must comply with the society of automotive engineers SAE J397a-1972, "deflection limiting volume for laboratory evaluation of roll-over protective structures (ROPS) and falling object protective structures (FOPS) of construction and industrial vehicles." Vehicles placed into initial service after February 9, 1995, must meet the requirements of SAE J397-1988.

(9) The opening in the rear of the ROPS on the crawler or rubber-tired tractors (skidders) must be covered with 1/4-inch diameter woven wire having not less than 1-1/2 inches or more than 2-inch mesh, or material which will afford equivalent protection for the operator.

(a) The covering must be attached to the structural members so that enough clearance is provided between the screen and the back of the operator.

(b) Structural members must be free from projections that would tend to puncture or tear flesh or clothing.

(c) Suitable safeguards or barricades must be installed, in addition to the screen, to protect the operator when there is a possibility of being struck by any material that could enter from the rear.

(10) Crawler and rubber-tired tractors (skidders) working in areas where limbs or brush may endanger the operator must be guarded.

(a) Shear or deflector guards must be installed on each side of the vehicle at an angle leading forward and down from the top front edge of the canopy of the vehicle, which will tend to slide the brush or limbs up and over the top of the canopy.

(b) Open mesh material with openings of a size that will reject the entrance of an object larger than 1-3/4 inches in diameter, must be extended forward as far as possible from the rear corners of the cab sides to give the maximum protection against obstacles, branches, etc., entering the cab area.

(c) Deflectors must also be installed ahead of the operator to deflect whipping saplings and branches.

(d) Deflectors must be located so as not to impede entrance to or exit from the compartment area.

(e) The floor and lower portion of the cab must be completely enclosed with solid material, except at entrances, to prevent the operator from being injured by obstacles which otherwise could enter the cab compartment.

(11) Each machine manufactured after August 1, 1996, must have a cab that is fully enclosed with mesh material with openings no greater than 2 inches (5.08 cm) at its least dimension. The cab may be enclosed with other material(s) where the employer demonstrates such material(s) provides equivalent protection and visibility.

EXCEPTION: Equivalent visibility is not required for the lower portion of the cab where there are control panels or similar obstructions in the cab, or where visibility is not necessary for safe operation of the machine.

Enclosures for agricultural and industrial tractors manufactured after September 1, 1972, must be constructed, designed and installed as detailed in the society of automotive engineers technical report J168.

(12) Overhead protection and other barriers must be installed to protect the operator from lines, limbs, and other moving materials on or over all loading or skidding machines and on all yarding machines where the operator's station is mounted on board. The overhead covering of each cab must be of solid material and extend over the entire canopy. A skylight in a logging machine must be made of safety glass or provide equivalent protection.

Note: This does not apply to self-loaders.

Reference: For requirements relating to overhead protection on forklifts, see chapter 296-863 WAC, Forklifts and other powered industrial trucks.

[Statutory Authority: RCW 49.17.010, 49.17.040, 49.17.050, 49.17.060, and chapter 49.17 RCW. WSR 17-17-131, § 296-54-57355, filed 8/22/17, effective 10/22/17. Statutory Authority: RCW 49.17.010, 49.17.040, 49.17.050, 49.17.060. WSR 06-07-142, § 296-54-57355, filed 3/21/06, effective 5/1/06. Statutory Authority: RCW 49.17.010, [49.17].040 and [49.17].050. WSR 99-17-117, § 296-54-57355, filed 8/18/99, effective 12/1/99.]

WAC 296-54-575 Landing area. (1) Unless otherwise specified, landing areas must:

(a) Be large enough that if logs are to be heeled and swung, they will not strike standing timber, rigging, or other equipment or objects;

(b) Be large and level enough to land and deck the logs in the turns so that they will not slide or roll in the direction of employees or equipment. This is not intended to restrict the yarding and/or loading of logs for pole piling or an infrequent long break or tree length, provided the log is secured before unhooking the choker;

(c) Be large enough for safe movement of all logs and machinery;

(d) Be free of root wads, limbs, tops, etc., that constitute a safety hazard; and

(e) Not have materials pushed, thrown, or dumped over the edge in a manner or at a time that will endanger employees.

(2) During roadside thinning, logs stacked on the roadside without a landing must be placed in a stable condition.

(3) During uphill yarding, the landing chute must be cleared of logs before the next turn of logs is landed unless:

(a) The logs are fully contained in the landing chute; or

(b) There is no possibility that employees working below the landing may be struck by rolling objects coming off the landing.

(4) Roadside or continuous landings must be large and wide enough to safely operate and maintain the yarding or loading equipment. Out-rigger pads, tracks or wheels must be on firm, stable ground.

(5) In logging operations where the yarder is set up in the haul road and logs are landed on the slope below the road, the following must apply:

(a) If the landing chute slope is twenty percent or less, logs may be landed and decked in the chute provided the logs can be left in a stable position;

(b) If the landing chute slope exceeds twenty percent, decking is not permitted in the chute if a chaser is required to unhook the rigging from the logs or if employees are working below the landing chute and are exposed to rolling or sliding logs;

(c) If logs are to be decked below the road, the logs must be effectively secured from rolling or sliding down the hill; or

(d) If the landing process or weather conditions (rain, snow, ice, mud) prevent the required log stability and exposes employees to the hazard of rolling or sliding logs, the logs must be decked at a different location.

[Statutory Authority: RCW 49.17.010, 49.17.040, 49.17.050, 49.17.060, and chapter 49.17 RCW. WSR 17-17-131, § 296-54-575, filed 8/22/17, effective 10/22/17. Statutory Authority: RCW 49.17.010, [49.17].040 and [49.17].050. WSR 99-17-117, § 296-54-575, filed 8/18/99, effective 12/1/99. Statutory Authority: RCW 49.17.040, [49.17].050 and [49.17].060. WSR 96-22-013, § 296-54-575, filed 10/28/96, effective 1/1/97. Statutory Authority: RCW 49.17.040, 49.17.050, 49.17.240, chapters 43.22 and 42.30 RCW. WSR 80-11-057 (Order 80-15), § 296-54-575, filed 8/20/80. Statutory Authority: RCW 49.17.040, 49.17.150 and 49.17.240. WSR 79-10-081 (Order 79-14), § 296-54-575, filed 9/21/79.]

WAC 296-54-577 Yarding, skidding, landing. (1) Running lines must be arranged so that employees are not required to work in the bight of the line. When employees must work in the bight, employees must move out of the bight of the lines before the signal to move the turn is given, or be in a position where they are protected by standing timber, terrain, or other objects large enough to ensure their safety.

(2) Choker holes must be dug from the uphill side of the log when there is danger of the log rolling or moving.

(3) Chokers must be placed near the end of the log/tree whenever possible.

EXCEPTION: When long logs or tree-length logs are being yarded and a long end is necessary to safely land the logs/trees on the available landing space.

(4) Employees must be in the clear of logs, root wads, chunks, hazardous trees, rolling material and rigging before the go-ahead signal is given and must stay in the clear until all rigging movement has stopped.

(5) Employees must move away from the turn so as to be above or behind the turn and in the clear. They must remain on their feet and face the turn before the go-ahead signal is given.

(6) All employees must remain away from rigging that is stopped at a hangup, until the rigging has been slacked to reduce the hazard.

(7) Chokers must not be hooked or unhooked until all rigging is stopped completely.

(8) Logs must not be landed until all employees, trucks or equipment are in the clear.

(9) Logs must not accumulate in the landing chute to the point where they become a hazard to the landing personnel.

(10) Logs must be stable and secure before being approached by employees and before chokers are unhooked.

(11) An employee must not buck, limb or trim logs from a position that will expose the employee to contact with moving lines.

(12) Logs must not be placed in, moved about, or removed from the bucking area of the landing unless all employees are in the clear.

(13) An unimpaired horizontal clearance of at least three feet must be maintained between the rotating superstructure of any logging machine working on a landing and any adjacent object or surface. If this clearance cannot be maintained, a safety zone barrier must be

used to isolate the hazardous area. The safety zone barrier may be a warning line constructed of rope or ribbon, supported on stanchions.

(14) Employees must not approach a machine's working circle until the operator has acknowledged that it is safe to do so.

(15) Whenever possible, chokers must be set from the uphill side of a log. Persons must not be on the lower side of a log which appears to be unstable or likely to roll.

(16) When yarding during the hours of darkness, the area must be lighted enough to allow employees to safely perform their duties. The source of light must be located and directed to create minimum shadows and glare. If using a portable tailhold, lights must be directed on equipment to allow the person to visually determine that the tailhold equipment remains stabilized.

(17) Each yarded tree/log must be placed in a location that does not create a hazard for an employee and in an orderly manner so that the trees/logs are stable before bucking or limbing is commenced.

(18) When using a yarder, loader or skidding machine, the location of the machine or position of the yarder must be such that the operator will not be endangered by incoming logs or debris.

(19) Employee(s) must be assigned to flag on roads or provide other equivalent protection where hazardous conditions are created from logging such as, but not limited to:

(a) Running wire rope lines or rigging across road grades, excluding guylines and standing skylines if lines remain a safe distance above the road to allow a vehicle to pass under; or

(b) The movement of logs, chunks, or debris across or suspended over road grades.

EXCEPTION: Where there is no through traffic, such as on a dead end road or where the property owner's permission or proper authority is granted to close a section of road, warning signs and barricades may be used instead of flagger(s).

[Statutory Authority: RCW 49.17.010, 49.17.040, 49.17.050, 49.17.060, and chapter 49.17 RCW. WSR 17-17-131, § 296-54-577, filed 8/22/17, effective 10/22/17. Statutory Authority: RCW 49.17.010, [49.17].040 and [49.17].050. WSR 99-17-117, § 296-54-577, filed 8/18/99, effective 12/1/99. Statutory Authority: RCW 49.17.040, 49.17.150 and 49.17.240. WSR 79-10-081 (Order 79-14), § 296-54-577, filed 9/21/79.]

WAC 296-54-579 Log decks. (1) Logs must be placed in and removed from decks in a straight and orderly manner so as to minimize the hazards from rolling or shifting logs.

(2) If employees are working on the ground near the deck, the deck must be constructed and located so it is stable and provides each employee with enough room to safely move and work in the area.

[Statutory Authority: RCW 49.17.010, [49.17].040 and [49.17].050. WSR 99-17-117, § 296-54-579, filed 8/18/99, effective 12/1/99. Statutory Authority: RCW 49.17.040, 49.17.150 and 49.17.240. WSR 79-10-081 (Order 79-14), § 296-54-579, filed 9/21/79.]

WAC 296-54-581 Helicopter logging—General. (1) Prior to daily logging operations, a briefing must be conducted. The briefing must set forth the plan of operation for the pilot(s) and ground personnel. Anytime a change in operating procedure is necessary, affected personnel must be notified.

(2) Employees and equipment must remain in the clear and employees must never be under a suspended load.

(3) Employees must not work under hovering craft except for that limited period of time necessary to guide, secure, hook/unhook loads, and perform maintenance/inspections or other related job duties.

(4) The location of the drop zone, decking areas, loading areas, and designated safety zones must be established by a pilot and a responsible supervisor taking into consideration current operating conditions.

(5) Personal protective equipment.

(a) Employees must wear high visibility hard hats secured by a chinstrap.

(b) Employees hooking and receiving the load must wear high visibility vests or outer garments.

(6) Whenever approaching or leaving a support helicopter with blades rotating, employees must:

(a) Remain in full view of the pilot and keep in a crouched position;

(b) Obtain a visual or audible acknowledgment from the pilot before entering or exiting the helicopter;

(c) Avoid the area from the cockpit or cabin rearward unless authorized by the helicopter company to work there; and

(d) Exercise special caution to keep clear of rotors when visibility is reduced.

(7) Before approaching or departing the service area for maintenance, visual and/or audible communication must be established.

(8) There must be reliable communication available between the helicopter, woods crew, landing, and service areas. In the absence of radio communication there must be a designated signal person.

(9) Developed hand signals must be clearly communicated and understood by all persons working in the area who may be affected by their use.

(10) Riding the load or hook of a helicopter is prohibited except in an emergency rescue situation.

(11) Unauthorized employees must not be allowed to approach within fifty feet of the helicopter when the rotor blades are turning.

(12) Every practical precaution must be taken to provide for the protection of employees from flying objects in the rotor downwash.

(13) Loads must be properly slung. Tag lines used by ground personnel to position loads must be of a length that will not permit their being drawn up into rotors. Pressed sleeve, swaged eyes, or equivalent means must be used for all freely suspended loads to prevent hand splices from spinning open or cable clamps from loosening.

[Statutory Authority: RCW 49.17.010, 49.17.040, 49.17.050, 49.17.060. WSR 06-07-142, § 296-54-581, filed 3/21/06, effective 5/1/06. Statutory Authority: RCW 49.17.010, [49.17].040 and [49.17].050. WSR 99-17-117, § 296-54-581, filed 8/18/99, effective 12/1/99. Statutory Authority: RCW 49.17.040, 49.17.150 and 49.17.240. WSR 79-10-081 (Order 79-14), § 296-54-581, filed 9/21/79.]

WAC 296-54-58110 Helicopter logging—Landing. (1) The landing drop zone must be large enough for the longest logs to be landed without endangering the landing crew.

(2) Landing crew must remain in the clear until the load is placed flat on the ground and chokers are released from the hook.

(3) Landings must be constructed with minimal slope for drainage in the drop zone and a decking area to prevent logs from rolling.

(4) The approach to the landing must be kept clear and long enough to prevent tree tops from being pulled into the landing.

(5) Landing personnel must be notified when chokers are being picked up.

(6) If the load will not release from the hook, the hook must be on the ground or at eye level, whichever is safer, before employees approach to release the hook manually.

[Statutory Authority: RCW 49.17.010, [49.17].040 and [49.17].050. WSR 99-17-117, § 296-54-58110, filed 8/18/99, effective 12/1/99.]

WAC 296-54-58120 Helicopter logging—Yarding. (1) Helicopters must not work in areas near enough to cutters to cause the rotor wash to affect a cutter's ability to safely control a tree or to cause dislodging of limbs.

(2) The yarding helicopter must be equipped with a siren to warn employees of any hazardous situation.

(3) Log pickup must be arranged so that the hookup crew will not work on slopes below fell and bucked timber that appears unstable and likely to roll.

(4) If the load must be lightened by the hooker, the hooker must remain on the uphill side of the load and slack given to the entire load before releasing the hook.

(5) If the load must be aborted or lightened by the pilot, the hooker must be in the clear before releasing the hook.

(6) Employees must remain in the clear as chokers are being delivered. Under no circumstances can employees move under the chokers being delivered or take hold of the chokers before they are placed on the ground.

[Statutory Authority: RCW 49.17.010, [49.17].040 and [49.17].050. WSR 99-17-117, § 296-54-58120, filed 8/18/99, effective 12/1/99.]

WAC 296-54-58130 Helicopter logging—Fueling area. (1) Separate areas must be designated for landing logs and for fueling helicopter(s).

(2) Refueling any helicopter with either aviation gasoline or Jet B (turbine) type fuel while the engine is running is prohibited.

(3) Helicopters using Jet A (turbine-kerosene) type fuel may be refueled with engines running provided the following criteria are met:

(a) Unauthorized employees must not be allowed within fifty feet of the refueling operation or fueling equipment; and

(b) Fire extinguishers must be strategically located in the fueling area and must have a combined rating of at least 20A:120BC.

(4) All fueling employees must be thoroughly trained in the refueling operation and in the use of the available fire extinguishing equipment they may be expected to use.

(5) The following are prohibited within fifty feet of the fueling area or fueling equipment:

(a) Smoking;

- (b) Open flames;
- (c) Exposed flame heaters;
- (d) Flare pots; and
- (e) Open flame lights.

EXCEPTION: Aircraft preheaters are not prohibited. However, no fueling may be performed while the heaters are in operation.

(6) The fueling area must be posted with "no smoking" signs.

(7) Because there are many causes of static electricity, fueling employees must assume that it is present at all times. Before starting refueling operations, the fueling equipment and the helicopter must be bonded and the fueling nozzle must be electrically bonded to the helicopter. Using conductive hose is not an acceptable method of bonding. All grounding and bonding connections must be electrically and mechanically firm to clean unpainted metal parts.

(8) To control spills, fuel must be pumped either by hand or power; pouring or gravity flow is prohibited. Self-closing nozzles or deadman controls must be used and must not be blocked open. Nozzles must not be dragged along the ground.

(9) In case of a spill, the fueling operation must be immediately stopped until the person in charge determines that it is safe to resume.

(10) Helicopters with their engines stopped while being refueled with aviation gasoline or Jet B (turbine) type fuel, must comply with subsection (4) through (9) of this section.

[Statutory Authority: RCW 49.17.010, 49.17.040, 49.17.050, 49.17.060, and chapter 49.17 RCW. WSR 17-17-131, § 296-54-58130, filed 8/22/17, effective 10/22/17. Statutory Authority: RCW 49.17.010, [49.17].040 and [49.17].050. WSR 99-17-117, § 296-54-58130, filed 8/18/99, effective 12/1/99.]

WAC 296-54-583 Loading logs. (1) A positive means of communication must be established and used between the truck driver and the employee loading logs to control the movement of the log truck being loaded.

(2) No one is permitted alongside or underneath trucks being loaded or on the load until communication has been established with the loading machine operator and the truck driver, and the employee is assured that it is safe to be there.

(3) Logs being moved or loaded must not pass over any employee or an occupied vehicle, equipment or truck cab.

(4) Standing between a truck cab and a log being loaded or unloaded is prohibited.

(5) Logs must not be lowered to the bunk while bunk or block adjustments are being made or until the employee making these adjustments is in the clear.

(6) Standing underneath a suspended trailer or its reach is prohibited.

(7) Loads must be built up or loaded in a manner to be stable without the use of wrappers. Wrappers are considered only as precautionary measures to ensure stability of the load.

(8) Where there is a danger of the grapple slipping off of logs, straps must be used in loading logs that are too large for the grapple or tongs and must be hung in both eyes.

(9) Logs must be loaded in a manner to prevent excessive strain on wrappers, binders, bunk stakes, bunk chains or straps.

(10) Logs in any tier or layer unsecured by stakes or cheese blocks must be well saddled and have their diameter centers inside the diameter centers of the outer logs of the next lower tier or layer.

(11) Bunk and wing logs must extend at least twelve inches beyond the front and rear bunks or stakes. When fixed bunks are used, logs must extend at least six inches beyond the front and rear bunk or stake.

(12) Double-ended logs above the stakes must not be loaded on the side of the load from which the binders or wrappers are intended to be released.

(13) Logs must be loaded so that no more than one-third of the weight of any log extends beyond the end of the logs or bunk supporting it.

(14) Logs must be loaded in a manner that will not impair full and free movement of the truck.

(15) Each log not contained within the stakes must be secured with at least two wrappers before the truck leaves the vicinity of the landing/loading area.

(16) All of the required wrappers must be placed on the load within sight of the landing/loading area so immediate emergency assistance can be given if necessary.

(17) Loads or logs must not be moved or shifted while binders are being applied or adjusted.

(18) The transport vehicle must be positioned to provide working clearance between the vehicle and the deck.

(19) All limbs or knots that would project beyond the stakes or legal height must be removed before the log is loaded on the car or truck.

Note: This does not apply to incidental limbs/knots placed on loads during the normal loading process.

(20) Power saws must not be operated on top of loaded logging trucks.

[Statutory Authority: RCW 49.17.010, 49.17.040, 49.17.050, 49.17.060, and chapter 49.17 RCW. WSR 17-17-131, § 296-54-583, filed 8/22/17, effective 10/22/17. Statutory Authority: RCW 49.17.010, [49.17].040 and [49.17].050. WSR 99-17-117, § 296-54-583, filed 8/18/99, effective 12/1/99. Statutory Authority: RCW 49.17.040, 49.17.150 and 49.17.240. WSR 79-10-081 (Order 79-14), § 296-54-583, filed 9/21/79.]

WAC 296-54-584 Tongs, hooks, grapples. (1) Tongs must be maintained in good condition, properly aligned and with sharp points.

(2) Tongs must not be carried by being rested on both shoulders with the tong points around the neck.

(3) When loading logs, straps of sufficient size and length must be used where there is a danger of tongs or hooks pulling out of the log.

(4) When loading logs, tongs may be used on large logs if the logs are barked and notched to ensure a secure hold.

(5) The closing line must be securely attached to the grapple according to the manufacturer's recommendations.

(6) Loading hooks and tongs must be securely attached on the loading line with screw shackles or equivalent devices.

[Statutory Authority: RCW 49.17.010, [49.17].040 and [49.17].050. WSR 99-17-117, § 296-54-584, filed 8/18/99, effective 12/1/99.]

WAC 296-54-585 Cross-haul systems. (1) In cross-haul (parbuckle) or roll-on loading systems, the skid timbers must be strong enough to support the logs being loaded and long enough to remain in place while the log is being loaded.

(2) Loaders on cross-haul systems must work beyond the ends of the logs being loaded.

[Statutory Authority: RCW 49.17.010, [49.17].040 and [49.17].050. WSR 99-17-117, § 296-54-585, filed 8/18/99, effective 12/1/99. Statutory Authority: RCW 49.17.040, 49.17.150 and 49.17.240. WSR 79-10-081 (Order 79-14), § 296-54-585, filed 9/21/79.]

WAC 296-54-587 Self-loading log trucks. (1) A safe means of access and egress must be provided to the operator's loading work station.

(2) Self-loading log truck operators must not unload their own load unless a positive means of securing the logs is provided when binders and wrappers are removed.

(3) New self-loading log trucks purchased and put in operation after January 1, 1980, must be equipped with:

(a) A check valve installed on the jib boom; and

(b) A seat that is offset from the point of attachment of the boom. The seat and boom structure must rotate concurrently.

(4) The operator of a self-loading log truck must not heel the log over the operator's work station.

[Statutory Authority: RCW 49.17.010, [49.17].040 and [49.17].050. WSR 99-17-117, § 296-54-587, filed 8/18/99, effective 12/1/99. Statutory Authority: RCW 49.17.040, 49.17.150 and 49.17.240. WSR 79-10-081 (Order 79-14), § 296-54-587, filed 9/21/79.]

WAC 296-54-589 Log trucks—General. (1) Prior to use, the operator must make a complete daily inspection of the truck and trailer with particular attention to:

- (a) Steering apparatus;
- (b) Lights and reflectors;
- (c) Brake boosters;
- (d) Brake hoses and connections;
- (e) Reaches;
- (f) Hitches (couplings);
- (g) Bunks;
- (h) Stakes;
- (i) Bunk blocks.

The brakes must be tested before and after movement of the vehicle. The operator must submit a written list of necessary repairs to a person designated by the employer.

(2) Any defective parts that would make the vehicle unsafe to operate, must be replaced or repaired before the vehicle is placed in service.

(3) Motor vehicles used on roads not under the control of the state department of transportation, counties, or cities must be equipped with accessories necessary for a safe operation including:

- (a) Operable head lamps;

- (b) At least two tail lamps and brake lamps that emit a red light plainly visible from a distance of one thousand feet to the rear; and
- (c) Two reflectors visible at night from three hundred fifty feet when directly in front of properly adjusted motor vehicle head lamps.
- (4) The driver must do everything reasonably possible to keep the truck under control at all times and must not operate in excess of a speed at which the driver can stop the truck in one-half the visible distance.
- (5) The area between the truck frame members, extending from the cab rearward as far as necessary to provide a safe work area, must be covered with suitable nonslip type material.
- (6) Log trucks that have logs scaled at stations must have a platform on each side extending outward from the frame members at least eighteen inches, and must be eighteen inches long or as near to eighteen inches as the design of the truck permits. The treading surface of the platforms must be of nonslip material and the platform must be able to safely support a five hundred pound load.
- (7) To protect the operator of vehicles from loads, there must be a substantial bulkhead behind the cab that extends up to the height of the cab.
- (8) When at the dump or reload or where logs are scaled or branded on the truck, the logs must be scaled or branded before the binders are released.
- (9) All vehicles, where vision of the operator in the direction of travel is impaired by the load or vehicle, must be moved only on a signal from a worker who has a clear view in the direction in which the vehicle is to be moved.
- (10) Where a bridge or other roadway structure is posted with a load limit sign, log truck drivers or operators of other heavy equipment are prohibited from driving a load in excess of the posted limit over such a structure.
- (11) All passengers must ride in the cab of the log truck.
- (12) All trucks must keep to the right side of the road except where the road is plainly and adequately posted for left side travel.
- (13) A method must be provided to ensure that the trailer will remain mounted on the truck while driving on highways or logging roads.
- (14) When trucks are towed on any road, the person guiding the vehicle being towed must, by prearranged signals, govern the speed of travel. Vehicles must be towed at a reasonable speed and in a prudent manner. A tow cable or chain over fifteen feet in length must have a white flag attached at the approximate center, however, it is recommended that a rigid tow bar be used for this purpose.
- (15) All rubber-tired motor vehicles must be equipped with fenders. Mud flaps may be used instead of fenders whenever the motor vehicle is not designed for fenders.
- (16) All trucks must be equipped with doors with operable latches, or a safety bar or strap.
- (17) Log trucks must not approach a landing while there is danger from incoming logs.
- (18) While en route, the operator must check and tighten the wrappers/binders whenever there is reason to believe that the wrappers/binders have loosened or the load has shifted.
- (19) Persons must not enter the area below a suspended load of logs.
- (20) All trucks must be equipped with a means to protect the operator from inclement weather.

[Statutory Authority: RCW 49.17.010, 49.17.040, 49.17.050, 49.17.060, and chapter 49.17 RCW. WSR 17-17-131, § 296-54-589, filed 8/22/17, effective 10/22/17. Statutory Authority: RCW 49.17.010, [49.17].040 and [49.17].050. WSR 99-17-117, § 296-54-589, filed 8/18/99, effective 12/1/99. Statutory Authority: RCW 49.17.040, 49.17.150 and 49.17.240. WSR 79-10-081 (Order 79-14), § 296-54-589, filed 9/21/79.]

WAC 296-54-58910 Log trucks—Brakes. (1) Motor logging trucks and trailers must be equipped with brakes or other control methods that will safely stop and hold the maximum load on the maximum grade.

(2) All trucks with air brakes must be equipped with a readily visual or audible low air pressure warning device in good working order.

(3) An air loss rate out-of-service condition exists if an air leak is discovered and the reservoir pressure is not maintained when:

- (a) The governor is cut in;
- (b) Reservoir pressure is between 80 and 90 psi;
- (c) Engine is at idle; and
- (d) Service brakes are fully applied.

[Statutory Authority: RCW 49.17.010, [49.17].040 and [49.17].050. WSR 99-17-117, § 296-54-58910, filed 8/18/99, effective 12/1/99.]

WAC 296-54-58920 Log trucks—Trailer hitches and safety chains.

(1) All log truck and trailer combinations must be equipped with approved hitches (couplings) which must:

- (a) Be capable of withstanding, in any direction, the potential stresses imposed;
- (b) Be of a design which would not be rendered inoperative by dirt and debris and must be locked securely and positively; and
- (c) Be attached to the truck frame or extension of the truck frame by means of not less than four machine bolts and nuts (120,000 psi material or better) inch diameter or larger, secured by lock nuts. Other means of attachment furnishing strength equal to or greater than the above may be accepted if of approved design and application.

(2) Hitches (couplings) or parts that are broken, cracked, excessively worn, or otherwise defective hitches must be repaired before use.

(3) Each log truck and trailer combination or log truck and independent trailer combination must be provided with two or more safety chains or cables with a rated breaking strength of at least the gross weight of the towed vehicle, and:

- (a) Able to hold the trailer in line in case of failure of the hitch assembly;
- (b) Permanently attached to the frame of the truck or an extension of the truck frame;
- (c) Form a separate continuous connection between the truck frame or extension of the truck frame and the reach or trailer;
- (d) Attached not more than twelve inches from the eye of the reach or trailer;
- (e) Short enough to prevent the trailer reach or tongue from contacting the ground in the event of disengagement from the truck;

(f) Designed to provide a positive connection that cannot be made inoperative by any condition of use or exposure.

(4) Safety chains and cables must be replaced immediately if they contain cut, cracked, or excessively worn links, or frayed, stranded, or otherwise defective wire rope.

(5) Butt welding of safety chain links to reach truck frame, or extension of truck frame is prohibited.

(6) Repairs to safety chains, such as cold shuts, are prohibited.

(7) Frames must not be welded or drilled into if the manufacturer recommends against it.

[Statutory Authority: RCW 49.17.010, [49.17].040 and [49.17].050. WSR 99-17-117, § 296-54-58920, filed 8/18/99, effective 12/1/99.]

WAC 296-54-58930 Log trucks—Reaches and bunks. (1) Log trailers must be connected to tractors by reaches of a size and strength to withstand all normal imposed stresses.

(2) Hand-holds or other facilities must be installed on trailer tongues or trailer reaches if workers are required to manually assist in coupling them to their tractors or trucks.

(3) The reaches of unloaded trailers being towed must have and use a minimum one-inch pin near the end or an equally effective means to prevent pulling or stripping through the tunnel.

(4) Reach locks, clamps, or tighteners must be of the type that will securely lock the reach in the tunnel.

(5) All reaches must be the maximum size usable in the tunnel of a trailer.

(6) Altering a trailer tunnel to permit reduction of reach size is prohibited.

(7) Every truck or truck and trailer engaged in transporting logs loaded lengthwise must be equipped with bunks and chock blocks or stakes.

(8) Log bunks or any part of a bunk assembly bent enough to cause bunks to bind, must be straightened. Bunks must be sharp enough to prevent logs from slipping.

(9) All trucks with swivel bunks must have bunk locks or an equivalent system of holding the bunks in place while loading logs.

(10) The bunks or bolsters of any truck or trailer must be either curved upward or straight. Bunks with ends lower than their centers are prohibited.

(11) Enough clearance must be maintained between the bunk and the bunk rider to prevent bunk binding.

(12) Trailer bunks must have a false or tilt bunk. The channel of the bunk must be kept reasonably free of debris.

(13) Stakes and stake extensions must be installed and maintained so that the angle between bunks and stakes (and extensions if used) do not exceed ninety degrees when loaded.

(14) Frames, bunks, and running gear of log trucks must be maintained free of cracks, breaks and defects. If defects are found, they must be immediately repaired or the part replaced.

[Statutory Authority: RCW 49.17.010, [49.17].040 and [49.17].050. WSR 99-17-117, § 296-54-58930, filed 8/18/99, effective 12/1/99.]

WAC 296-54-58940 Log trucks—Stakes, stake extensions and chock blocks. (1) Trucks and trailers must be equipped with bunk stakes or chock blocks of strength and sized material to perform their intended function.

(2) All stakes, stake extensions, and bunks installed on log trucks and trailers, together with the means to secure and lock the stakes in hauling position, must be designed and constructed of materials of such size and dimension that will withstand operational stresses without yield or permanent set.

(3) Stake extensions made from axle shafts or other brittle material are prohibited.

(4) The linkage used to support the stakes or chocks must be of adequate size and strength to withstand the maximum imposed impact load. Molles or cold shuts are prohibited in chains or cables used for linkage.

(5) Stake chains or cables must be equal to or better than "high test" steel chain or "plow steel" wire rope, and of a size necessary to meet the requirements of a safe working load of at least six thousand six hundred pounds. (3/8-inch alloy chain, 7/16-inch high test chain of welded link construction, and 5/8 inch improved plow steel cable in 6 x 19 and 6 x 37 construction meet this requirement.)

(6) Bunk chains containing cut, cracked, excessively worn, or otherwise defective links, must be immediately removed from service. Molles, cold shuts (welded or otherwise), or bolts are not permitted in bunk chains.

(7) The use of frayed, stranded, or otherwise defective wire rope for chock block cable or stake straps is prohibited.

(8) Only chain links approved for welding (and properly welded) or approved repair links that will develop strength equivalent to the chain, are permissible for repairs or attachments to stake chains or binder chains.

(9) Chains or cables used to secure stakes or chock blocks must be secured in a way that does not require hammering directly on them to release the stakes or blocks. Keyhole slots and similar methods of securing chains are prohibited.

(10) Deformed or defective stakes, stake securing or stake locking devices, or bunks must be immediately repaired or removed from service.

(11) Each stake and chock used to trip loads must be constructed so that the tripping mechanism is activated on the side opposite the release of the load.

(12) Trip type stakes must be properly secured and locked in a manner that will prevent them from accidentally tripping or falling.

[Statutory Authority: RCW 49.17.010, [49.17].040 and [49.17].050. WSR 99-17-117, § 296-54-58940, filed 8/18/99, effective 12/1/99.]

WAC 296-54-58950 Log trucks—Wrappers and binders. (1) On log trucks equipped with stakes, the following requirements must apply:

(a) In the hauling of a one log load, one wrapper chain or cable must be required and secured to the rear bunk. The log must be properly blocked or secured in a manner which will prevent it from rolling or shifting. An additional wrapper secured to the front bunk is optional.

(b) In the hauling of two log loads, not less than two wrapper chains or cables must be used to secure the load. The logs must be properly blocked to prevent them from rolling or shifting.

(c) On loads consisting of three or four logs not over forty-four feet in length, the load must be secured by not less than two properly spaced wrapper chains or cables. Ends of short logs not secured by such wrappers must be secured with extra wrappers. If any log is over forty-four feet in length, the load must be secured by not less than three properly spaced wrappers.

(d) Loads consisting of five or more logs:

(i) When the logs are all seventeen feet or less in length, the load must be secured by not less than two properly spaced wrappers.

(ii) When any log is over seventeen feet in length, the load must be secured by not less than three properly spaced wrappers. Log(s) loaded on top or in outside saddles of a load must not be transported unless secured by at least two wrapper chains or cables, one of which must be placed near each end of such log.

(2) On log trucks equipped with chock blocks the following requirements must apply:

(a) In the hauling of a one log load, one wrapper chain or cable shall be required and secured to the rear bunk and the log must be properly blocked in a manner to prevent it from rolling or shifting.

(b) One additional wrapper chain or cable shall be required on log trucks using chock blocks over and above the requirements in subsection (1) (c) and (d) of this section.

(3) In the case of short logs loaded crosswise, the following method of securing the load must be used if the truck or trailer is not provided with solid ends of a height sufficient to prevent any log in the load from rolling off:

Not less than two chock blocks must be used at each open end of the vehicle and the load must be held with at least two wrapper chains or cables. The wrappers must be firmly attached to the end of the truck or trailer. Rigid standards or stakes may be used in lieu of chock blocks but each such standard or stake must be either rigidly connected to the bed of the truck or trailer or must be placed in a tight-fitting socket at least 12 inches in depth. Other means furnishing equivalent security may be acceptable.

(4) When two wrappers are required, they must be applied within six feet of the front and rear bunks. When more than two wrappers are required, the front and back binder must be applied within six feet of the front and rear bunks.

(5) To properly secure short logs, binders must be placed near the end, not less than twelve inches from the end of the log.

(6) Log(s) loaded on top or in outside saddles of a load must not be transported unless secured by at least two wrapper chains or cables, one of which must be placed near each end of such log.

(7) All wrappers and binders must be fastened in place prior to tightening to prevent the displacement of logs on the top of the load.

(8) All wrapper chains or cables, except in the case of one log load, must entirely surround the load. This does not apply to gut-wrappers.

(9) Gut-wrappers, when used, must be adjusted so as to be tightened by, but not carry the weight of the logs above them.

(10) Wrappers must not be thrown over the load until personnel are in the clear.

(11) Each log not contained within the stakes must be secured with at least two wrappers before the truck leaves the vicinity of the landing/loading area.

(12) While moving logs, poles, or log chunks within sorting or mill yards, that could roll or slide off the truck due to snow or ice conditions, or the logs or log chunks do not extend beyond the stakes, at least two wrappers and binders must be used regardless of the height of the load.

(13) Wrapper chains or cables, binders, fasteners, or attachments thereof, used for any purpose as required by these standards must have a minimum breaking strength of not less than fifteen thousand pounds and must be rigged so that it can be safely released.

Note: 3/8-inch hi-test steel chain, 7/16-inch improved plow steel wire rope of 6 x 19 or 6 x 37 construction, or materials having equivalent strength, when in compliance with the requirements herein contained, will be acceptable. (The diameter of the wire rope is immaterial as long as it meets the minimum breaking strength requirements.)

Note: Nylon straps and ratchet binders having an equivalent breaking strength may be used when securing loads on (hay rack) log hauling systems.

(14) A loaded logging truck required to have wrappers by this section, may be moved within the loading area without wrappers only if such movement does not present a hazard to workers.

(15) For the purposes of this standard, applied bundle straps or banding are not acceptable as wrappers and binders.

(16) All loose ends of wrapper chains or cables must be securely fastened so as to prevent their swinging free in a manner that will create a hazard.

(17) Binders for securing wrappers on logging trucks must be fitted with hooks of proper size and design for the wrapper chain being used.

(18) Wrappers must be removed from service when any of the following conditions exist:

- (a) Excessively worn links on chains;
- (b) Deformed or stretched chain links;
- (c) Cracked chain links; or
- (d) Frayed, stranded, knotted, or otherwise defective wire rope.

(19) Pipe extension handles (swedes) for tightening or securing binders must be no longer than thirty-six inches. Care must be taken that a sufficient amount of the pipe extends over the binder handle.

(20) Defective binders must be immediately removed from service.

Note: See Figures 25 through 35 for illustrations of placement and number of wrappers.

**Placement and Number of Wrappers
One Log Load**

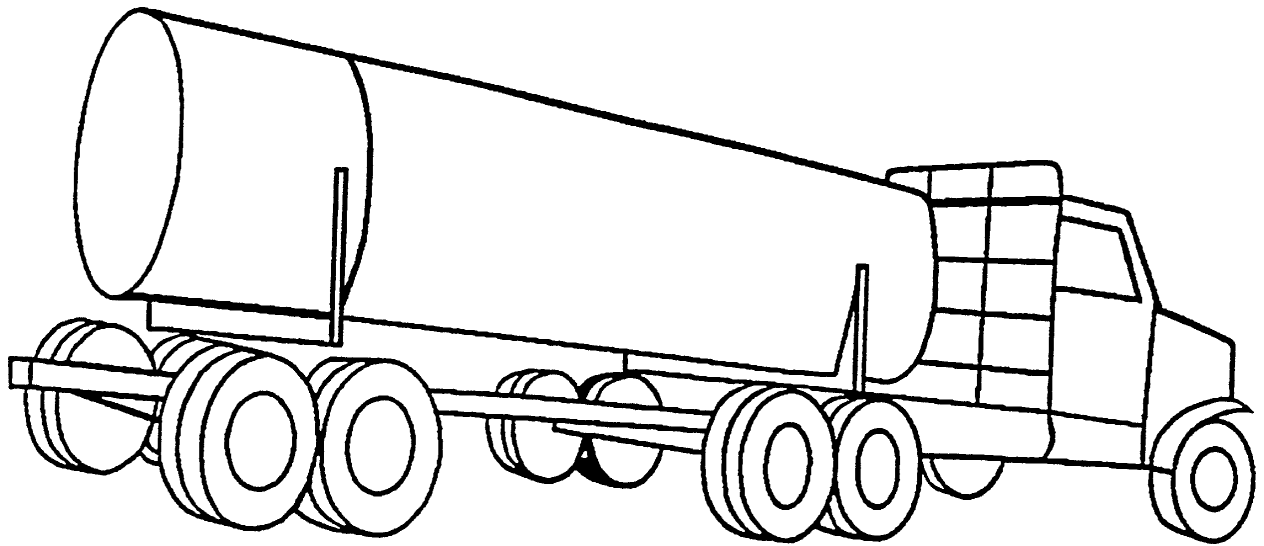

Figure 25: One Log Load
Two Log Load

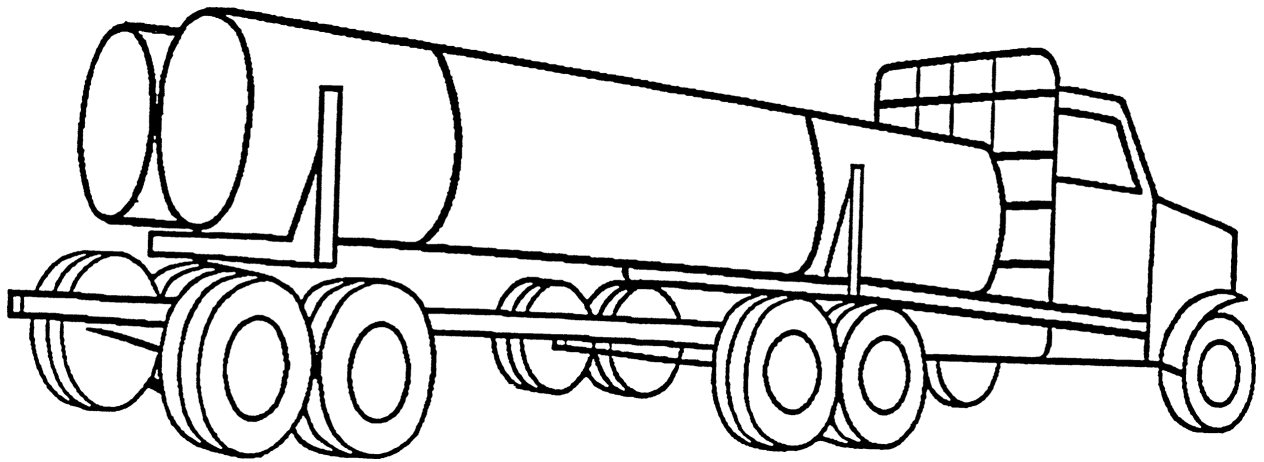

Figure 26: Two Log Load
Three or Four Log Load 44 Ft. or Less

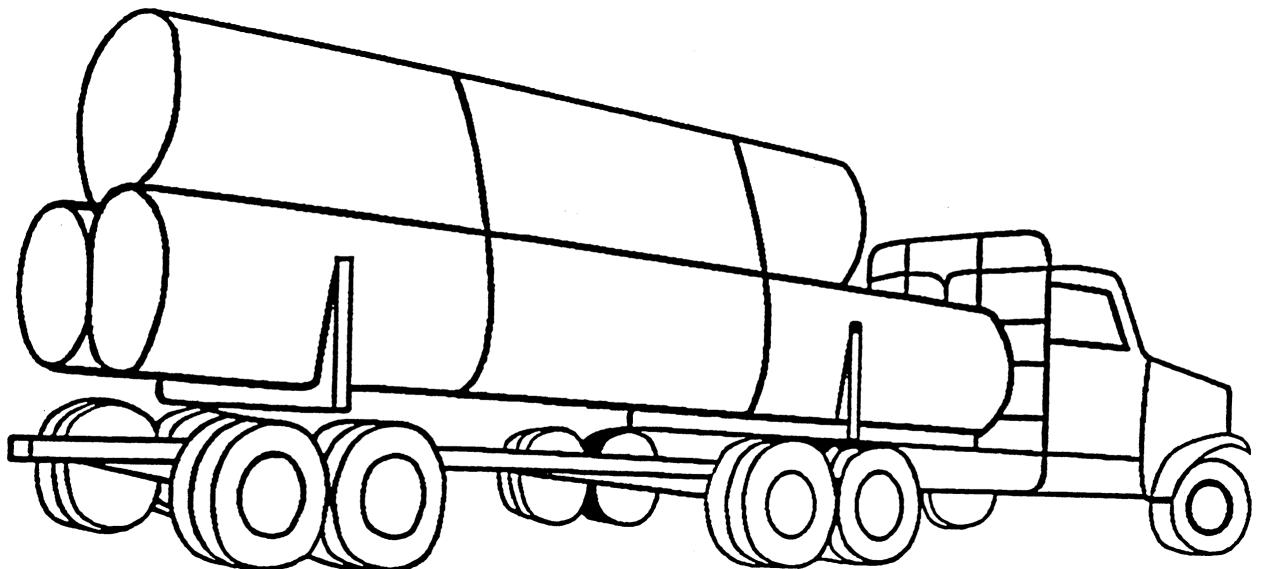

Figure 27: Three or Four Log Load 44 feet or less

Three or Four Log Loads More Than 44 Feet

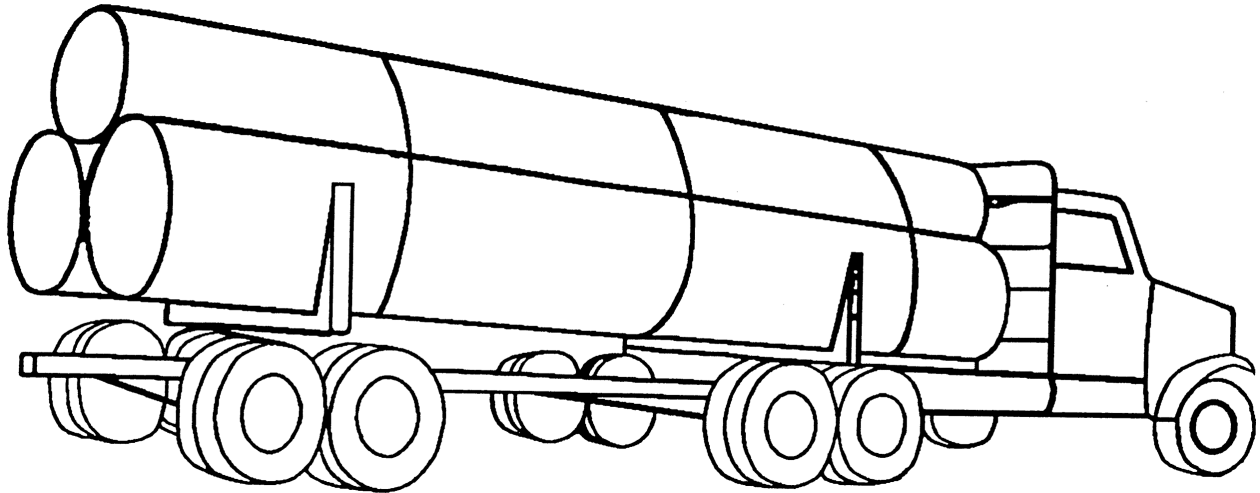

Figure 28: Three or Four Log Loads more than 44 feet

Five or Six Log Load All Logs 17 Feet or Less

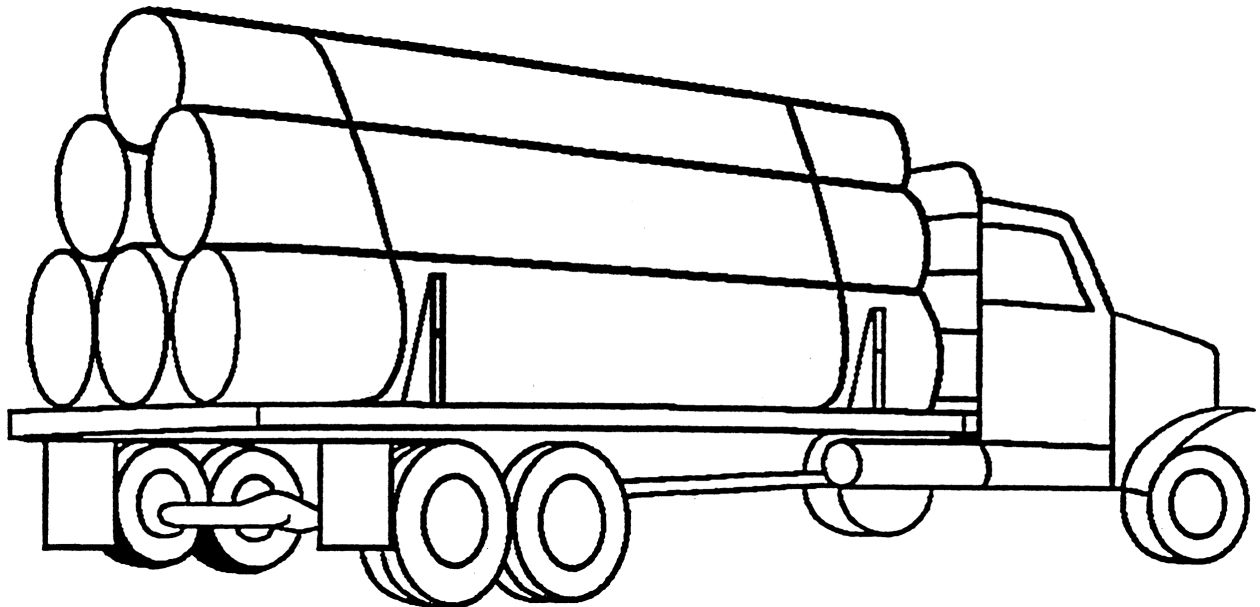

Figure 29: Five or Six Log Load All Logs 17 feet or less

Seven or More Log Load All Logs 17 Feet or Less

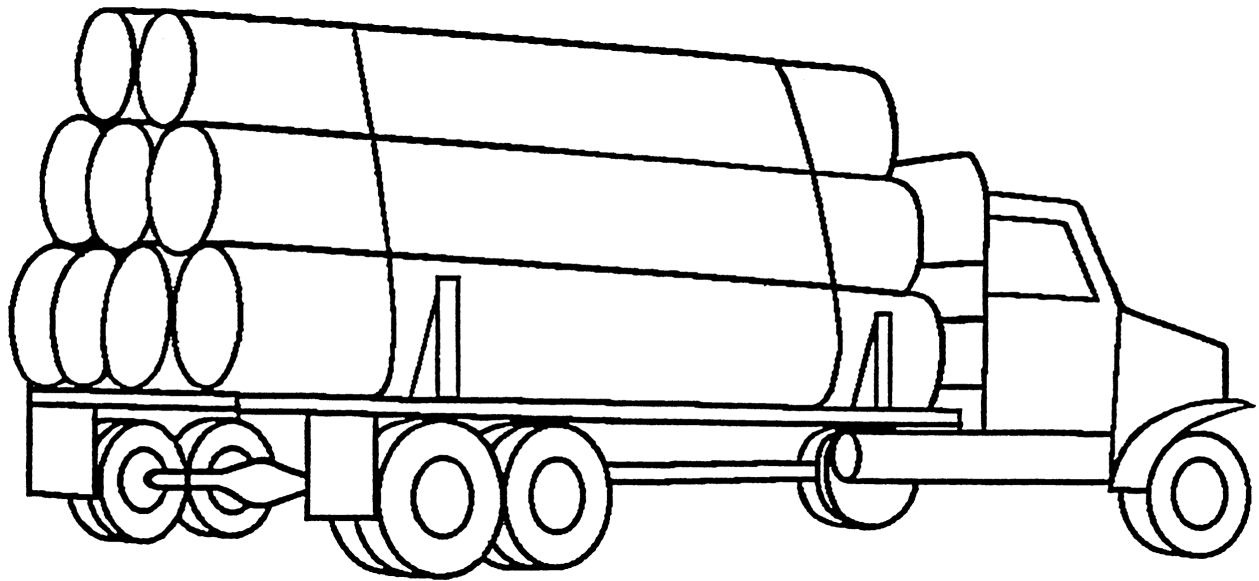

Figure 30: Seven or More Log Load all Logs 17 feet or less
Five or More Log Load If Any Logs Are More Than 17 Feet

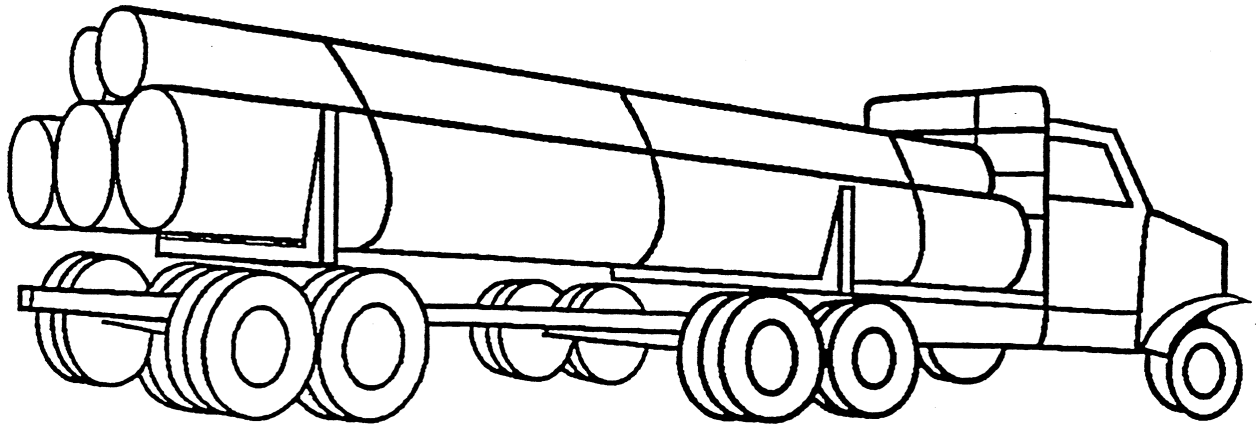

Figure 31: Five or More Log Load if any Logs are more than 17 feet
Proper Support for Logs

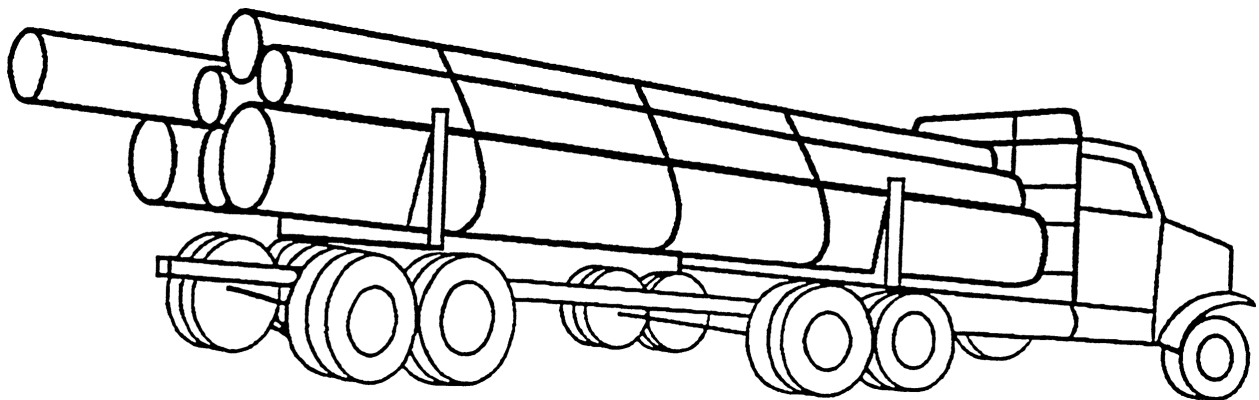

Figure 32: Proper Support for Logs
Outside Logs or Top Logs

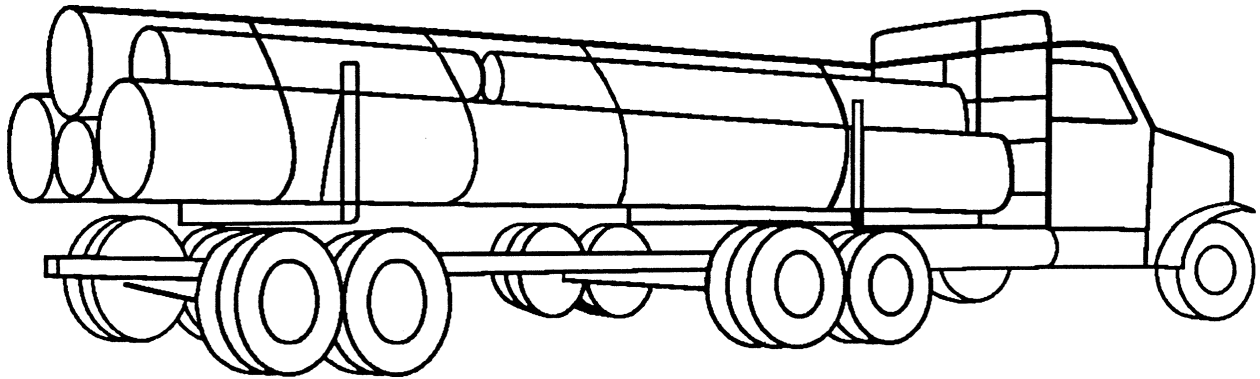

Figure 33: Outside Logs or Top Logs
A Wrapper Must Be Near Each Bunk

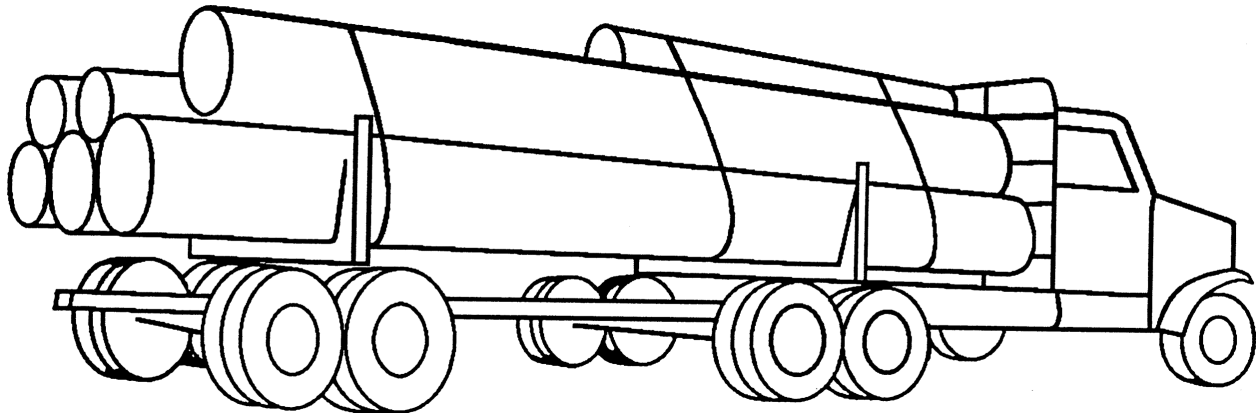

Figure 34: A Wrapper must be near each bunk
Short Logs Loaded Crosswise

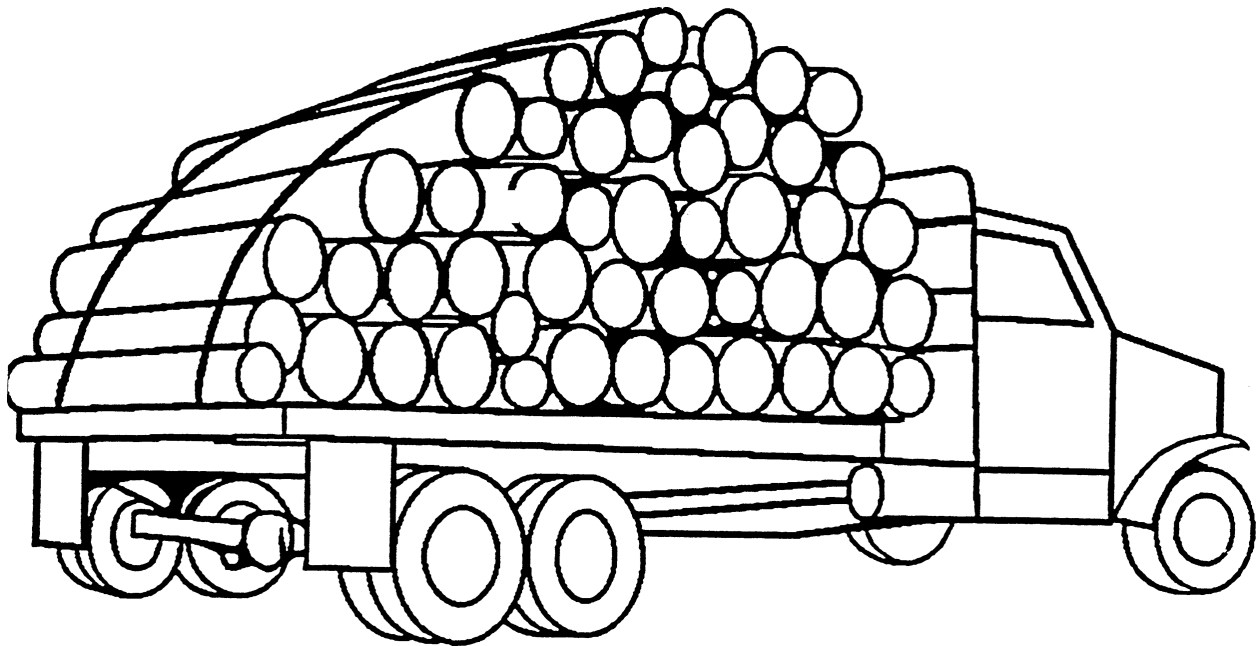

Figure 35: Short Logs Loaded Crosswise

Note: All loads of logs on logging trucks equipped with chock blocks instead of stakes, must have at least one additional wrapper over and above the requirements for trucks equipped with stakes, except on one and two log loads and trucks with short logs loaded crosswise.

[Statutory Authority: RCW 49.17.010, 49.17.040, 49.17.050, 49.17.060, and chapter 49.17 RCW. WSR 17-17-131, § 296-54-58950, filed 8/22/17, effective 10/22/17. Statutory Authority: RCW 49.17.010, [49.17].040 and [49.17].050. WSR 99-17-117, § 296-54-58950, filed 8/18/99, effective 12/1/99.]

WAC 296-54-58960 Log trucks—Miscellaneous requirements. (1) A truck wheel must not have more than twenty-five percent of the lugs missing or defective.

(2) All truck wheels must be maintained free of cracks, breaks, or defects.

(3) Windshields on all equipment must have windshield wipers in good working condition.

(4) Mule train trailers must have a platform on the trailer tongue at least twelve inches by twenty-four inches made of nonslip material and able to support at least three hundred pounds. The platform must be self-cleaning.

(5) Trailer loading and unloading straps, links, or chains must be fastened securely to the trailer frame and used in hoisting the trailer. The connections must be maintained in good condition and not be attached to the trailer bunk. Using molles for this purpose is prohibited.

(6) When unloading trailers from trucks, the trailers must be hoisted clear, the truck driven forward a safe distance, and the trailer lowered to within one foot of the roadway before persons approach the trailer or reach.

(7) Trailer hoisting or unloading straps must be constructed and installed in a manner enabling the loading or unloading machine to engage the strap without manual personal contact.

(8) All motor vehicles must be equipped with a horn that is audible above the surrounding noise level. The horn must be sounded before operating the vehicle in reverse gear and when necessary to alert employees.

[Statutory Authority: RCW 49.17.010, [49.17].040 and [49.17].050. WSR 99-17-117, § 296-54-58960, filed 8/18/99, effective 12/1/99.]

WAC 296-54-58970 Log trucks—Steered trailers. Steered trailers, not controlled from the truck cab, must be designed, constructed, and operated as follows:

(1) A secure seat with substantial foot rest must be provided for the operator at the rear of the bunk. Any arrangement that permits the operator to ride in front of the bunk is prohibited unless a false bunk or other adequate protection is provided for the operator.

(2) The seat for the operator must be so arranged that he has an unobstructed exit from both sides and the rear.

(3) The bunk support must be so constructed that the operator has a clear view ahead at all times.

(4) Adequate means of communication must be provided between the operator and the truck driver.

(5) Eye protection and respirator must be provided for the operator.

(6) The trailer must be equipped with fenders or splash plates to protect the operator from mud and dust so far as possible.

(7) If used during periods of reduced visibility on roads not under the control of the state department of transportation, counties, or cities, the trailer must be equipped with head, tail, turn and stop lights.

[Statutory Authority: RCW 49.17.010, [49.17].040 and [49.17].050. WSR 99-17-117, § 296-54-58970, filed 8/18/99, effective 12/1/99.]

WAC 296-54-591 Stationary log truck trailer loading. (1) All loading devices must be designed, constructed and maintained so as to have a five to one safety factor for the rated load capacity.

(2) Loaders must be high and wide enough so they can safely load the maximum-sized trailers they are expected to handle without hanging up or striking the equipment.

(3) Electric-powered trailer loading devices must be equipped with a switch or device that will safely limit the upper direction of travel of the load line.

(4) Electric motors used for hoisting must be equipped with approved overload switches or breakers.

(5) Electrical switch controls must not exceed twenty-four volts. All control switches must be the momentary-contact type that require continuous manual pressure for the hoist to operate.

(6) Pendant control switches must be suspended by a chain or other suitable device that will prevent placing a strain on the electrical cable.

(7) Pendants must be installed so that the control switch does not touch the ground when retracted.

(8) All electrical equipment must be weatherproof-type or adequately protected from the weather, and must meet or exceed the requirements of the National Electrical Code as promulgated by the director of the department of labor and industries pursuant to RCW 19.28.060.

(9) Trailer loaders, except A-frames or bridge crane, must be equipped with reach guides or devices that will keep the reach in proper alignment. A tag rope or other safe guidance device must be used to guide trailers being loaded by an A-frame loader.

(10) Access roads and the area around the trailer loading devices must be kept free of standing water and debris and maintained in good repair.

(11) The maximum capacity load to be lifted must be posted in a conspicuous location where it can be easily seen by any person operating the hoist.

(12) Trailer loading equipment must be periodically inspected at least every thirty days and must be maintained in good repair. A written report must be made and signed by the person making the inspection and kept on file by the company for twelve months.

(13) You must conduct an annual lifting test on each loading device and maintain a written record of the test.

(a) The written record must contain:

(i) The date of the test;

(ii) The name of person conducting the test;

(iii) The amount of weight lifted; and

(iv) The results kept in the office of the employer or at the site.

(b) The test weight must be at least one hundred twenty-five percent of the maximum rated load and a maximum of one hundred thirty percent of the maximum rated load.

(14) Each drum must be designed and arranged in such a manner that the line will maintain lead and spool evenly without chafing, crossing, or kinking.

(15) A braking system must be installed that has the ability to safely brake and hold one and one-half times weight of the full rated load.

(16) When trailers are to be loaded after dark, sufficient lights must be provided for a safe operation.

[Statutory Authority: RCW 49.17.010, 49.17.040, 49.17.050, 49.17.060, and chapter 49.17 RCW. WSR 17-17-131, § 296-54-591, filed 8/22/17, effective 10/22/17. Statutory Authority: RCW 49.17.010, [49.17].040 and [49.17].050. WSR 99-17-117, § 296-54-591, filed 8/18/99, effective 12/1/99. Statutory Authority: RCW 49.17.040, 49.17.150 and 49.17.240. WSR 79-10-081 (Order 79-14), § 296-54-591, filed 9/21/79.]

WAC 296-54-593 Log unloading, booms, and rafting grounds—Storage and sorting areas—General. (1) At least two persons must be present for all storing, sorting, or boom work, except for boomboat operations.

(2) Employees working on, over, or along water, where there is a danger of drowning, must be provided with and wear approved personal flotation devices.

(a) Employees are not considered exposed to the danger of drowning when:

(i) Employees work behind standard height and strength guardrails;

(ii) Employees work inside operating cabs or stations that will prevent accidentally falling into the water; or

(iii) Employees wear approved safety belts with lifeline attached to prevent falling into the water.

(b) Before and after each use, personal flotation devices must be inspected for defects that would reduce their designed effectiveness. Using a defective personal flotation device is prohibited.

(c) An approved personal flotation device must be approved by the United States Coast Guard as a Type I PFD, Type II PFD, Type III PFD, or Type V PFD, or their equivalent, as required in 46 C.F.R. 160 (Coast Guard Lifesaving Equipment Specifications) and 33 C.F.R. 175.23 (Coast Guard table of devices equivalent to personal flotation devices). Ski belt or inflatable personal flotation devices are prohibited.

(3) In operations where regular logging machinery, rigging, etc., is used, the applicable rules apply.

(4) You must provide and ensure the use of artificial lights where employees work between the hours of sunset and sunrise. The lights must be located in a manner that will:

(a) Be reasonably free of glare;

(b) Provide uniform distribution of illumination; and

(c) Avoid sharply defined shadows.

(5) On all log dumps, adequate power for the unloading method used must be provided. All machines used for hoisting, reloading, or

lowering must be of an approved design and have enough power to control or hold the maximum load imposed in mid-air.

(6) Methods of unloading logs must be arranged and used in a manner to provide full protection to all employees.

(7) Binders must not be released from any load until an effective safeguard is provided.

(8) All mobile log handling machines must be equipped with a means to prevent the logs from accidentally leaving the forks, and it must be used.

(9) The operator of the unloading machine must have an unobstructed view of the unloading area or must make certain no one is in the area where the logs are to be unloaded. Rearview mirrors must be installed on mobile log handling equipment to assist the operator in determining that the area behind the machine is clear before backing up.

(10) Unloading lines must be arranged so that it is not necessary for an employee to attach them on the pond or dump side of the load.

(11) Life rings with a minimum of ninety feet of 1/4-inch line with a minimum breaking strength of five hundred pounds attached, must be provided at convenient points adjacent to water that is five feet or more in depth. Life rings must be a minimum of thirty inches outside diameter and seventeen inches inside diameter and be maintained so as to retain a thirty-two pound positive buoyancy.

[Statutory Authority: RCW 49.17.010, 49.17.040, 49.17.050, 49.17.060, and chapter 49.17 RCW. WSR 17-17-131, § 296-54-593, filed 8/22/17, effective 10/22/17. Statutory Authority: RCW 49.17.010, 49.17.040, 49.17.050, 49.17.060. WSR 06-07-142, § 296-54-593, filed 3/21/06, effective 5/1/06. Statutory Authority: RCW 49.17.010, [49.17].040 and [49.17].050. WSR 99-17-117, § 296-54-593, filed 8/18/99, effective 12/1/99. Statutory Authority: RCW 49.17.040, [49.17].050 and [49.17].060. WSR 96-22-013, § 296-54-593, filed 10/28/96, effective 1/1/97. Statutory Authority: RCW 49.17.040, 49.17.050, 49.17.240, chapters 43.22 and 42.30 RCW. WSR 80-11-057 (Order 80-15), § 296-54-593, filed 8/20/80. Statutory Authority: RCW 49.17.040, 49.17.150 and 49.17.240. WSR 79-10-081 (Order 79-14), § 296-54-593, filed 9/21/79.]

WAC 296-54-59310 Log unloading, booms, and rafting grounds—Water dumps. (1) All water dumps must have brow logs except when logs are lifted from the load. If portable equipment is used, adequate stops must be provided to prevent equipment from running off the dump.

(2) Where necessary for employees to walk alongside loads and equipment on trestles or fills, a minimum twenty-two inch wide walkway must be provided, unless otherwise specified.

(3) All decks and plankways on log dumps must be kept in good repair and free from bark and other debris. Roadways must not be inclined more than one inch to twelve inches across the driving surface.

(4) The use of small bridge-over logs, planking, or timbers between regular foot logs, or walkways, which will not support the weight of at least three persons are prohibited. All regular foot logs must be barked on the upper side.

(5) Electric-powered hoists using hand-held cord remote controls in grounded locations must be actuated by circuits operating at no more than twenty-four volts. All control switches must be the momenta-

ry contact type that require continuous manual pressure for the hoist to operate.

(6) Roadbeds at log dumps must be hard-packed gravel, heavy planking, or equivalent material, and must be of sufficient width and even surface to ensure safe operation of equipment.

(7) Where logs are unloaded on to rollways, enough space must be provided between the top of the skids and the ground to clear the body of a person.

(8) When a brow log is used with a parbuckle system, all persons are prohibited from going between the brow log and the load of logs at any time.

(9) A positive safeguard must be provided to prevent logs from leaving the loads on the side opposite the dump. Unloading lines, crotch lines, or other equivalent means must be arranged and used in a manner to prevent any log from swinging or rolling back.

(10) All employees must remain in the clear until all moving equipment has come to a complete stop.

(11) Logs must not be unloaded by peaves or similar manual methods, unless means are provided and used that eliminate the danger from rolling or swinging logs.

[Statutory Authority: RCW 49.17.010, [49.17].040 and [49.17].050. WSR 99-17-117, § 296-54-59310, filed 8/18/99, effective 12/1/99.]

WAC 296-54-59320 Log unloading, booms, and rafting ground—Boom and rafting grounds. (1) Breaking of log jams by peavy method is prohibited, except in river drive or when a jam occurs away from a mechanical means or the dump.

(2) Wooden pike poles must be made of continuous, straight-grained No. 1 material.

(a) Defective poles, blunt or dull pikes must not be used.

(b) Conductive pike poles must not be used where there is a possibility of coming in contact with energized electrical conductors.

(3) Stiff booms must be made of at least two boom sticks and must be at least thirty-six inches wide measured outside to outside of the logs. The boom sticks must be fastened with at least 4" x 6" cross ties, or cable lashings notched into the boom sticks may be used when stiff booms are exposed to heavy swells. Stiff booms must be kept free of loose bark and maintained in good repair.

(4) A walkway thirty-six inches wide with standard hand railing must be provided from the shore end of stiff boom to shore.

(5) All sorting gaps must have a substantial stiff boom on each side of gaps. Such stiff booms or walkways must be planked over.

(6) Boom sticks must be reasonably straight with no protruding knots or loose bark. They must be able to support above the water line at either end the weight of one employee and equipment or two hundred fifty pounds.

(7) Foot logs must be reasonably straight with no protruding knots or loose bark and large enough to support above the water line at either end the weight of two employees and equipment or five hundred pounds.

(8) Unsafe boom sticks must be marked by three chopped crosses ten feet from the butt end, and those sticks must not be used as boom sticks.

(9) Gaps between boom sticks must not exceed twenty-four inches. All wire must be removed from boom sticks and boom chains before they are reused or hung in rafting stalls.

(10) When permanent cable swifters are used, they must be arranged so that they are within easy reach of the rafter without rolling the boom sticks on which they are fastened. When cables become hazardous to use because of jagers, they must be discarded.

(11) When a floating donkey or other power-driven machinery is used on a boom, it must be placed on a raft or float with enough buoyancy to keep the deck of the raft or float well above water. Wherever employees walk, the deck of the raft or float must be planked over with at least two inch planking, and kept in good repair.

(12) When doglines used in rafting, brailing, or stowing logs become hazardous to use because of jagers, they must be discarded.

(13) Sufficient walkways and floats must be installed and securely anchored to provide safe passage for employees.

(14) Walkways alongside sorting gaps must be at least four feet wide. Other walkways must be at least twenty-two inches wide.

[Statutory Authority: RCW 49.17.010, [49.17].040 and [49.17].050. WSR 99-17-117, § 296-54-59320, filed 8/18/99, effective 12/1/99.]

WAC 296-54-59330 Log unloading, booms, and rafting grounds—Boats and mechanical devices on waters. (1) Before starting the boat motor, any spilled fuel must be removed and vapors must be exhausted from any area in which they may accumulate.

(2) The bilge area must be kept clean and oil, grease, fuel, or highly combustible materials must not be allowed to accumulate.

(3) Adequate ventilation equipment must be provided and used for the bilge area to prevent the accumulation of toxic or explosive gases or vapors.

(4) Adequate ventilation equipment must be provided and used for the cabin area on enclosed-cabin boats to prevent an accumulation of harmful gases or vapors.

(5) Deck and cabin lighting must be provided and used where necessary to provide safe levels of illumination aboard boats. Boats operated between sunset to sunrise, or in conditions of restricted visibility, must display navigation lights as required by the United States Coast Guard. Searchlights or floodlights must be provided for safe navigation and to illuminate working or boarding areas adjacent to the craft.

(6) On craft used by employees wearing calked shoes, all areas where employees must stand or walk must be made of or be covered with wood or other suitable matting or nonslip material. The covering must be maintained in good condition.

(7) Each boat must:

(a) Be provided with a fire extinguisher; and

Note: For additional requirements relating to portable fire extinguishers see WAC 296-800-300.

(b) Have a life ring with at least fifty feet of one-fourth inch line attached.

Note: On log broncs, boomscoters, or other small boomboats where all occupants are required to wear life saving devices and a life ring would present a tripping hazard, the life ring may be omitted.

(8) Along docks, walkways, or other fixed installations on or adjacent to open water more than five feet deep, approved life rings with at least ninety feet of one-fourth inch line attached, must be

provided. The life rings must be spaced at intervals not exceeding two hundred feet and must be easily visible and readily accessible.

(a) When employees are assigned work at other casual locations where exposure to drowning exists, at least one approved life ring with at least ninety feet of line attached must be provided in the immediate vicinity of the work assigned.

(b) Lines attached to life rings on fixed installations must be at least ninety feet long, at least one-fourth inch in diameter, and have a minimum breaking strength of five hundred pounds. Similar lines attached to life rings on boats must be at least fifty feet long.

(c) Life rings must be United States Coast Guard approved thirty-inch size.

(d) Life rings and attached lines must be maintained to retain at least seventy-five percent of their designed buoyancy and strength.

(e) Where work is assigned over water where the vertical drop from an accidental fall would exceed fifty feet, special arrangements must be made with and approved by the department of labor and industries prior to such assignment.

(9) Log broncs, boomscooters, and boomboats must not be loaded with employees or equipment in a way that adversely affects stability or seaworthiness.

(10) Boats must not be operated at excessive speed or handled recklessly.

[Statutory Authority: RCW 49.17.010, [49.17].040, and [49.17].050. WSR 01-17-033, § 296-54-59330, filed 8/8/01, effective 9/1/01; WSR 99-17-117, § 296-54-59330, filed 8/18/99, effective 12/1/99.]

WAC 296-54-59340 Log unloading, booms, and rafting grounds—Dry land sorting and storage. (1) Unauthorized foot and vehicle traffic is prohibited in the sorting or storage area.

(2) Logs must be stored in a safe and orderly manner. Roadways and traffic lanes must be kept clear of protruding ends of logs and debris.

(3) Dry deck log storage areas must be kept orderly and maintained in a condition conducive to safe operation of mobile equipment. Roadways and walkways must have a smooth hard-packed surface wide enough to permit a safe operation. Bark, mud, and other debris must not be allowed to accumulate to the extent they constitute a hazard to the operation.

(4) You must implement an effective method to control dust at log dumps and in sorting and storage areas.

(5) Only an authorized person will operate or ride any lift truck, log stacker, or log unloader.

(6) Signaling log unloader operators at dry deck areas by throwing bark or chips in the air is prohibited. Hand, horn signals or other safe, effective means must be used at all times.

(7) Unnecessary talking to the operator while operating controls of a log stacker or log unloader is prohibited.

(8) Lift forks and arms of unloading machines must be lowered to their lowest position, and all equipment brakes set before the operator leaves the machine unattended.

(9) Log unloaders or stackers must not be moved about the premises for distances greater than absolutely necessary with the lift ex-

tended above the driver's head or with loads lifted higher than is necessary for vision.

(10) When truck drivers are out of the cab, they must be in the clear, and in view of the log unloader before the lift forks are moved under the load and the lift is made.

(11) Where logs are offloaded onto a dry deck by unloading lines, a self-releasing mechanism must be used. Employees are prohibited from climbing dry decks to release unloading lines.

(12) Employees must not enter the hazardous area near or under loads of logs being lifted, moved, or suspended.

(13) When log unloaders and log stackers are designed so that logs being handled may jeopardize the safety of the operator, you must provide overhead protection and any other necessary safeguards.

(14) Log unloaders and log stackers must be equipped with a horn or other audible warning device. If vision is impaired or restricted to the rear, the warning device must be sounded before operating the vehicle in reverse gear and periodically while backing. The warning device must be operative at all times.

(15) A limit stop, which will prevent the lift arms from over-traveling, must be installed on electric powered log unloaders.

(16) Shear guards must be installed on unloading machines and similar equipment on which the arms pivot and move alongside the operator creating a pinch point at that location.

(17) All forklift log handling machines must be equipped with a grapple arms and the arms must be used whenever logs are being carried.

(18) When log trucks are loaded by a log stacker and the lay of any log is higher than the stakes, the log stacker must remain against the completed load, or other suitable protection provided, to prevent the logs from falling until at least two wrappers and binders have been applied.

(19) All binders and wrappers must remain on the load until an approved safeguard has been provided to prevent logs from rolling off the side of the truck or trailer when binders are released. A shear log, or equivalent means, must be provided to ensure the log truck will be stationed close enough to the wrapper rack so that a log cannot fall between the log truck and the wrapper rack when removing binders and wrappers. At least one binder must remain secured while relocating or tightening other binders. Crotch lines, forklifts, log stackers, log unloaders, or other effective means must be used for this purpose.

(20) An extra wrapper or metal band of equal strength must be placed to hold the logs when it is necessary to remove a wrapper to prevent it from being fouled by the unloading machine.

(21) Machines with arms that block the regular exit when in the up position must have an emergency exit installed.

(22) Riding on any part of a log handling machine except under the canopy guard is prohibited.

(23) Identification tags must not be applied or pulled unless logs are resting in a stationary place, such as bunks, cradles, skids, or sorting tables.

(24) Employees must not approach the immediate vicinity of a forklift-type log handling machine without first notifying the operator of the person's intention and receiving an acknowledgement from the operator.

(25) When dry land log dumps use unloading methods similar to those of water dumps, the safety standards for water dumps apply.

(26) When logs are handled between sunset and sunrise or other periods of poor visibility, you must provide illumination that meets the requirements of WAC 296-800-210 relating to illumination.

(27) Air operated stake releases must meet the following requirements:

(a) The air supply must be taken from the "wet" air reservoir or from the accessory air line to a spring loaded, normally closed control valve;

(b) The control valve must be located in the cab, positioned so that it is accessible only from the operator's position;

(c) The control valve must be fitted with a spring-loaded cover or otherwise guarded against inadvertent operation; and

(d) A separate air line must extend from the control valve to the tractor and trailer stake release chambers. The air line must be clearly identified or installed so that it cannot be mistaken for the service or emergency air line.

(28) Each deck must be constructed and located so it is stable and provides each employee with enough room to safely move and work in the area.

[Statutory Authority: RCW 49.17.010, 49.17.040, 49.17.050, 49.17.060, and chapter 49.17 RCW. WSR 17-17-131, § 296-54-59340, filed 8/22/17, effective 10/22/17. Statutory Authority: RCW 49.17.010, [49.17].040, and [49.17].050. WSR 01-11-038, § 296-54-59340, filed 5/9/01, effective 9/1/01; WSR 99-17-117, § 296-54-59340, filed 8/18/99, effective 12/1/99.]

WAC 296-54-601 Signals and signal systems. (1) Standard hand or whistle signals as described in this chapter must be used for the movement of rigging, logs, or equipment when using a high lead, slackline, or cable skidder system for yarding. For hand signal illustrations, see appendix 1.

(2) Voice communication may be used to move rigging and control movement of logs, provided a standard audible whistle signal is sounded before any line is moved.

Note: Subsections (1) and (2) of this section do not apply to grapple or other special yarding systems where employees are not exposed to the movement of logs or rigging.

(3) Voice communications may be used for grapple yarding under the following conditions:

(a) Voice communications by use of radio frequencies may be used to transmit instructions and directions to the yarder operator when using a grapple type logging system, if no employee is in a hazardous area near live rigging.

(b) Voice communication may be used to instruct the yarder operator when picking up an occasional log with the use of a choker on a grapple system, if the grapple is on the ground before the setting of the choker and no lines are moved by the operator until the person setting the choker has returned to a safe location away from any running lines. When a number of logs must be yarded by using chokers instead of the grapple, the requirements for high lead logging apply.

(4) Voice communication on the same radio frequencies used to transmit skyline, high-lead, slackline or skidder whistle signals (154.57 and 154.60 MHz channels), must be limited to reporting injuries, fire, and emergency situations where special tools or precautions are needed to prevent or alleviate a hazardous situation. In addition:

(a) The rigging crew must call the yarder engineer by name to ensure that proper contact is established;

(b) The yarder engineer must acknowledge the call with a whistle "stop" signal before the caller starts transmitting the voice message;

(c) Voice transmission must be kept as brief and to the point as possible; and

(d) After receiving the voice message, the yarder engineer must again acknowledge with a whistle "stop" signal that the message has been received and is clearly understood.

(5) If a standard signal is not listed for an unusual or new situation, a hand or whistle signal other than any listed for the type of yarding being done may be used for the specific situation only. Any special signals developed must be understood by all persons working in the area who may be affected by their use.

(6) A copy of the standard hand and whistle signals must be available at the worksite.

(7) Only one person in any crew must give signals at the point where chokers are being set. Any person is authorized to give a stop signal when someone is in danger or another emergency condition is apparent.

(8) Hand signals are permitted only when the signal person is in plain sight of the machine operator and when visibility allows signals to be seen. Hand signals may be used at any time as an emergency stop signal.

(9) Throwing of any type of material or relying on engine noise, such as from a chain saw, as a signal is prohibited.

(10) All persons must be in the clear before any signal is given to move the rigging, logs, or turns. Rigging, logs, or turns must not be moved until after the proper signals have been given.

(11) Machine operators must not move any line unless the signal received is clear and distinct. If in doubt, the operator must repeat the signal as understood and wait for confirmation.

(12) A horn or whistle that is automatically activated by the radio or electric signaling system must be used on each yarder used for skyline, high lead, skidder or slackline system of yarding, except where hand signals or voice communication as described in subsection (2) of this section is permitted. The horn or whistle must emit a sound that is clearly audible to all persons in the affected area and must be sounded before any line is moved. Such a horn or whistle is also required on combination yarding and loading machines and tree pullers. Audible signals are not necessary on grapple or other yarding systems where persons are not exposed to the movement of logs or rigging.

(13) All radio-controlled motorized carriages and skycars must have a warning horn which must be sounded before any lines or loads are moved or an audible whistle must be sounded from the yarder.

(14) Each unit of the signal or control system in use must be tested daily before logging operations begin. Audible signals used for test purposes must not include signals used for the movement of lines or materials.

(15) Citizen band (CB) radios must not be used to activate any signal, machine, or process, either automatically or by voice. CB radios may be used for communication between sides, vehicles, work units, or for emergency situations.

(16) When audible whistle signals are being used simultaneously by yarding and loading machines at a landing, signal whistle or horn tones used in connection with machine movements must be so differenti-

ated as to distinctively identify any intended work movement of either machine.

(17) When the normal rigging crew configuration consists of two or more persons at the point where chokers are being set, at least two members of the rigging crew must carry transmitters for each signal and control system being operated where chokers are being set. Only one transmitter for each signal and control system is required if:

(a) The signal person has no other duties and remains in an area where there are no hazards created by the moving rigging or logs; or

(b) The rigging crew is comprised of only one employee.

(18) The use of a jerk wire whistle system for any type of yarding operation is prohibited.

[Statutory Authority: RCW 49.17.010, 49.17.040, 49.17.050, 49.17.060, and chapter 49.17 RCW. WSR 17-17-131, § 296-54-601, filed 8/22/17, effective 10/22/17. Statutory Authority: RCW 49.17.010, [49.17].040 and [49.17].050. WSR 99-17-117, § 296-54-601, filed 8/18/99, effective 12/1/99. Statutory Authority: RCW 49.17.040, [49.17].050 and [49.17].060. WSR 96-22-013, § 296-54-601, filed 10/28/96, effective 1/1/97. Statutory Authority: RCW 49.17.040, 49.17.050, 49.17.240, chapters 43.22 and 42.30 RCW. WSR 80-11-057 (Order 80-15), § 296-54-601, filed 8/20/80. Statutory Authority: RCW 49.17.040, 49.17.150 and 49.17.240. WSR 79-10-081 (Order 79-14), § 296-54-601, filed 9/21/79.]

WAC 296-54-603 Electric signal systems. (1) Where an electrical signal system is used, all wires, attachments, and connections must be weatherproof.

(2) Electric signal systems must be properly installed and adjusted. They must be protected against accidental signaling and must be maintained in good operating condition at all times. Enough signal wire must be provided to enable good voice contact between the whistle punk and rigging crew at all times.

[Statutory Authority: RCW 49.17.010, [49.17].040 and [49.17].050. WSR 99-17-117, § 296-54-603, filed 8/18/99, effective 12/1/99. Statutory Authority: RCW 49.17.040, 49.17.150 and 49.17.240. WSR 79-10-081 (Order 79-14), § 296-54-603, filed 9/21/79.]

WAC 296-54-604 Radio signaling permits. To apply for a new radio signaling permit, to request a change in a permit, or to request a change in the use area for any permitted system, write to:

WISHA Services Division—Permits
Department of Labor & Industries
P.O. Box 44655
Olympia, WA 98504-4655

[Statutory Authority: RCW 49.17.010, 49.17.040, 49.17.050, 49.17.060, and chapter 49.17 RCW. WSR 17-17-131, § 296-54-604, filed 8/22/17, effective 10/22/17. Statutory Authority: RCW 49.17.010, [49.17].040 and [49.17].050. WSR 99-17-117, § 296-54-604, filed 8/18/99, effective 12/1/99.]

WAC 296-54-605 Radio systems used for voice communication, activation of audible signals, or control of equipment. (1) A valid operating permit must be obtained by the owner from the department of labor and industries, prior to putting into use any radio signaling or control system intended to be used in conjunction with any type of cable logging operations.

(a) Permits will be issued only for systems licensed for such use and using those carrier frequencies as authorized by the Federal Communications Commission.

(b) Permits will be granted only when tone or function frequencies are compatible with other radio systems in use and when in compliance with all other applicable requirements of this chapter.

(2) The department of labor and industries reserves the right to designate the use of radio frequencies for specific purposes or functions. For example: Frequencies may be specified for voice transmission of instruction, others for tone-coded functions, or activation of signaling devices.

(a) Single tone coded functions must not be used on radio equipment designed to initiate whistle signals, or to activate or control any machine, material-handling device, or other equipment hazardous to employees.

(b) The department may also designate which tone frequencies may be used for the activation of a signaling device or for control of equipment on certain federal communication assigned carrier frequencies.

(3) A list of tone frequencies that may be used with any Federal Communications Commission assigned carrier frequencies will be made available from the department upon request.

(4) The department will assign the area or areas in which a radio signaling system may be used and mark those areas on the permit. Radio signaling systems must not be used in any area other than the ones indicated on the permit. (See Figure 36: Areas for Use of Radio Signaling Systems for Logging Operations.)

(5) The person or firm name on the permit must be the same as the person or firm operating the radio signaling system except for loaner or rental sets. A person or firm using a loaner or rental set is responsible for the radio signal system as if they were the owner of the set.

(6) The application for a permit to use a radio signaling system must contain the following information (see Figure 37: Application for permit to operate radio signal system in designated area):

(a) Name and address of applicant.

(b) The radio frequencies of the radio signaling device in MHz.

(c) The tone frequencies of the radio signaling system used to activate a horn, whistle, or control equipment in Hz. The security gate, or pulse tone, must be shown first.

(d) The name of the manufacturer of the radio signaling system.

(e) The serial number of the receiving unit.

(f) The state assigned area or location in which the unit will operate.

(g) The type of signaling used.

(h) From whom the system was purchased or acquired, and the date of acquisition of the system.

(i) Intended use and function of the system.

(7) All radio equipment must meet all applicable FCC standards. FCC identifier numbers and required information must be visible when possible.

(8) Radio equipment must not be used without displaying a permit as required by this standard. The permit must be prominently displayed on the outside case of the receiver of the unit or, for radio-controlled carriages, on the transmitter in the yarder.

(9) Each radio receiver must have its radio carrier frequency in MHz and tone frequency(s) in Hz indicated on the outside case of the receiver (see Figure 38: Radio permit):

(a) The manufacturer's name and serial number must be permanently indicated on the outside of the case;

(b) When the duration or width of the tone frequencies performs a function, the one duration/width must also be permanently indicated on the outside of the receiver case;

(c) Each transmitter must be identified with its receiver; and

(d) Two or more receivers in operation simultaneously on the same tone frequencies are prohibited unless one is used for monitoring only.

(10) It will be the responsibility of the owner of any radio signaling system to notify the department of labor and industries, immediately, if the signal system is:

(a) Permanently retired (in what manner and date retired);

(b) Sold (submit name and address of purchaser and date sold);

(c) Removed from the state (name of state to which moved and date moved); or

(d) Stolen (date).

(11) All radio signaling systems put into use for the first time after the effective date of these safety standards, must meet or exceed the minimum performance specifications contained in WAC 296-54-607 of these safety standards, and, when altered or repaired, must continue to meet such specifications.

(12) Adjustments, repairs, or alterations of radio signaling and control devices must be done only by or under the immediate supervision and responsibility of a qualified and certified radio technician with factory training or equivalent certified experience. Anyone without the technical ability or the proper equipment to cause the signaling systems to function within required tolerances must not attempt to repair, alter, or adjust the systems.

(13) When interference, overlap, fadeout, or blackout of radio signals is encountered, the use of the device must be discontinued immediately. Use may not be resumed until the source of trouble has been detected and corrected.

(14) Radio frequencies assigned to systems for which voice communications may be used to give signals to the yarder operator must not be the same frequencies as those assigned for whistle signals or machine control signals used in skyline, highlead, slackline, or cable skidder systems.

(15) When hazardous interference is created by moving a voice communication system into an area where a system is already in use on the same frequency, use of the newly moved system must be immediately discontinued until the problem of interference has been corrected.

(16) Before moving any unit from one assigned geographical area to another (see area map, Figure 36: Areas for Use of Radio Signaling Systems for Logging Operations), the owner must apply for and receive a new permit from the department.

AREAS FOR USE OF RADIO SIGNALING SYSTEMS FOR LOGGING OPERATIONS

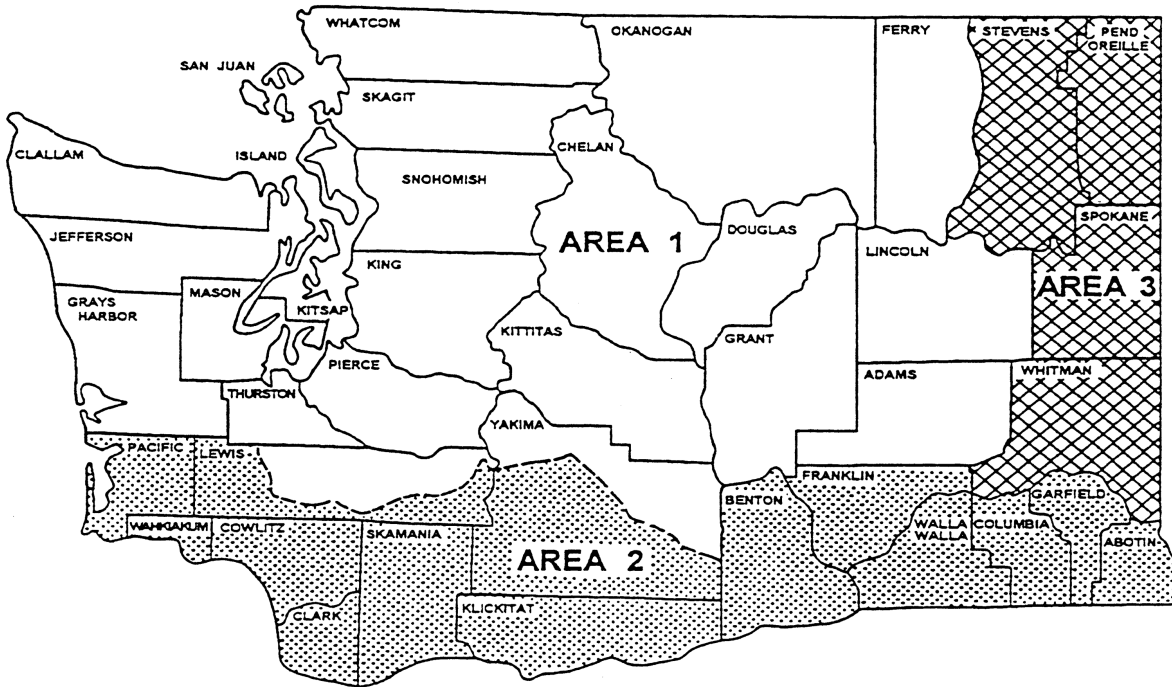

STATE OF WASHINGTON
 DEPARTMENT OF LABOR AND INDUSTRIES
 DIVISION OF INDUSTRIAL SAFETY AND HEALTH
 Figure 36: Areas for Use of Radio Signaling Systems for Logging Operations

Form No. 157.

STATE OF WASHINGTON

5-71

DEPARTMENT OF LABOR AND INDUSTRIES

DIVISION OF SAFETY

**APPLICATION FOR PERMIT
 TO OPERATE RADIO SIGNAL SYSTEM IN DESIGNATED AREA**

Radio Carrier Frequency Serial No.

Tone Coding Frequency Hz Name of Manufacturer of
 Signal System

Firm Name Address By.....

Intended Function of Unit: Voice communication Whistle signal Control Equipment

Area in which Unit will be Operated: 1 2 3
 (Area map included in Safety Standards for Logging Operations)

Type of Tone: Sequential Simultaneous If other specify type

System to be Used For: Grapple Skyline, Highlead, Slackline, Skidder Balloon

System Purchased or Acquired From

Date System Purchased or Acquired: Day Month Year

Mail Permit to

Date Application Mailed to Division of Safety/...../.....
 Day Mo. Year

Date Permit Issued/...../.....
	Day Mo. Year
DIV. OF SAFETY USE ONLY	

Figure 37: Application for Permit to Operate Radio Signal System in Designated Area

Department of Labor and Industries Division of Occupational Safety and Health PO Box 44655 Olympia, WA 98504-4655			Radio Permit
Serial No.		Carrier Frequency	
		MHZ	
Area	Tones		
		HZ	
Firm Name			
Issued by: DEPARTMENT OF LABOR AND INDUSTRIES			

Figure 38: Radio Permit

A permit issued by the department of labor and industries shall be attached to the outside of the receiver which shall indicate the area in which the radio signaling equipment may be used.

[Statutory Authority: RCW 49.17.010, 49.17.040, 49.17.050, 49.17.060, and chapter 49.17 RCW. WSR 17-17-131, § 296-54-605, filed 8/22/17, effective 10/22/17. Statutory Authority: RCW 49.17.010, [49.17].040 and [49.17].050. WSR 99-17-117, § 296-54-605, filed 8/18/99, effective 12/1/99. Statutory Authority: RCW 49.17.040, [49.17].050 and [49.17].060. WSR 96-22-013, § 296-54-605, filed 10/28/96, effective 1/1/97. Statutory Authority: Chapter 49.17 RCW. WSR 88-23-054 (Order 88-25), § 296-54-605, filed 11/14/88. Statutory Authority: RCW 49.17.040, 49.17.150 and 49.17.240. WSR 79-10-081 (Order 79-14), § 296-54-605, filed 9/21/79.]

WAC 296-54-607 Radio signal systems—Specifications and test procedures. All radio-signaling systems put into use must meet or exceed the requirements of this section. When systems are altered or repaired they must continue to meet these requirements.

(1) Radio equipment in use at cable logging sites, which is primarily used for voice communication, must be on a separately assigned frequency from radio equipment primarily used to initiate whistles or other audible signaling devices or to control any machine, material handling device or other equipment hazardous to employees.

(2) Radio-signaling systems used to transmit whistle signals or control functions of equipment associated with skyline, highlead, slackline, or cable skidder systems of logging must transmit and decode only by the use of authorized multitone frequencies. Only sequential tones may be used to transmit signals or control equipment when using carrier frequencies of 154.57 or 154.60 MHz.

(3) All radio systems receiver sensitivity must be able to attain 0.4 microvolt, or greater, for 12 dB SINAD ratio for VHF frequencies and 0.5 microvolt, or greater, for UHF frequencies. When interference is a factor, the receiver may be desensitized in the furtherance of safety by a person qualified according to WAC 296-54-605(12).

(4) All radio signal systems must have receiver spurious attenuation of at least 70 dB when measured by the 20 db quieting method and image response attenuation of 60 db when measured by the 20 db quieting method.

(5) All radio signal systems must have receiver selectivity of at least 80 db plus or minus 30 KHz, when measured by the E.*I.A. SINAD method.

(6) The receiver-decoder tone frequency stability must not exceed 0.006 (0.6%) above or below the assigned tone frequency.

(7) The drift of a transmitter-encoder tone must not exceed 0.006 (0.6%) above or below the assigned tone frequency.

(8) Parts of the radio-signaling system affected by moisture, which may be subjected to the entrance of moisture during use, must be weatherproofed. Transmitters must be tested within fifteen minutes after being subjected to the following conditions and must have the ability to continue functioning properly. The transmitter and receiver must be placed in a humidity chamber for eight hours where the humidity has been maintained at not less than ninety percent and where a 40 degrees C. temperature has been maintained.

(9) Radio-signaling system units must operate within tolerances specified at any temperature within the range of -30 degrees C. to +60 degrees C.

(10) Switches of transmitters used to send whistle signals or activate equipment associated with high lead, slackline, or cable skidder systems of logging must be designed so that two buttons, motions or a combination of these are required simultaneously to cause activation of the system. Arrangement of the activating switches must allow the operator to transmit signals easily but not easily activate a control or command function accidentally.

(11) All receivers intended to be mounted on or in the yarder or similar equipment, and all portable transmitters, must continue to maintain specified mechanical and electrical performance during and after being subjected to vibration of the magnitude and amplitude as follows:

(a) The equipment must be vibrated with simple harmonic motion having an amplitude of 0.015" (total excursion 0.03") with the frequency varied uniformly between 10 and 30 Hz and an amplitude of 0.0075" (total excursion 0.015") with the frequency varied uniformly between 30 and 60 Hz.

(b) The entire cycle of frequencies for each group (i.e., 10 to 30 cycles and 30 to 60 cycles) must be accomplished in five minutes and repeated three times.

(c) The above motion must be applied for a total of thirty minutes in each direction, that is, the directions parallel to both axes of the base and perpendicular to the plane of the base.

(12) All portable transmitters must be able to maintain specified mechanical and electrical performance after being subjected to a shock test as follows: The transmitter must be dropped five times from a height of four feet onto a smooth concrete floor. Each drop must impact a different surface of the transmitter.

(13) Transmitters operating on carrier frequencies of 154.57 MHz and on 154.60 MHz must be limited on maximum power output of 500 mW measured at the antenna terminals.

(14) To minimize the possibility of interference with other signaling systems, the input power of transmitters operating in the 450 MHz range should be limited to only the amount needed to transmit to the receiver of the system effectively.

[Statutory Authority: RCW 49.17.010, 49.17.040, 49.17.050, 49.17.060, and chapter 49.17 RCW. WSR 17-17-131, § 296-54-607, filed 8/22/17, effective 10/22/17. Statutory Authority: RCW 49.17.010, [49.17].040 and

[49.17].050. WSR 99-17-117, § 296-54-607, filed 8/18/99, effective 12/1/99. Statutory Authority: RCW 49.17.040, 49.17.150 and 49.17.240. WSR 79-10-081 (Order 79-14), § 296-54-607, filed 9/21/79.]

WAC 296-54-701 Wood spar trees. (1) Wood spar trees must be of sound material of sufficient size and strength to withstand any stresses which may be imposed by any equipment used for that specific logging operation.

(2) The top of the tree must not extend more than:

(a) Sixteen feet above the top guylines on spar trees over fifty feet tall; and

(b) Eight feet above the top guylines on spar trees less than fifty feet tall.

(3) School marms used as spar trees must be topped at the forks. Spar trees, except cedar, must be barked where guylines, straps, bull blocks, and tree plates are placed.

(4) Spar trees must be topped and limbs must be cut off close so that running lines will not foul or saw on protruding knots.

(5) At least four tree plates must be placed under top guylines on spar trees over fifty feet tall. At least three tree plates must be used on spar trees less than fifty feet tall.

(6) Tree plates must be equipped with lugs or other suitable means to hold them in place.

(7) Before raising spar trees, dummy trees must be topped and guyed with three guylines equivalent in breaking strength to the mainline.

(8) When spar trees are raised, stumps used for snubbing must be properly notched. Guylines must be held by a mechanical means. Snubbing by hand is prohibited.

(9) All rub trees must be limbed and topped.

(10) Loose material such as bark, spikes, straps or chains not in use and slabs caused by bumping logs or chafing straps must be removed from the spar trees. Heavy bark must be removed from trees used for a permanent installation.

(11) A person must ride only the passline to thread lines, to lubricate blocks, or to inspect rigging.

(12) When the friction lever and passline drum are on the opposite side of the machine from the operator, an experienced person operates the friction lever while the engineer operates the throttle. While being used, the passline drum must be properly attended by another person to guide the passline onto the passline drum with a tool suitable for the purpose.

(13) Using a gypsy drum to handle employees in the tree is prohibited.

(14) A climber's rope must encircle the tree before the climber leaves the ground, except when the climber is riding the passline.

(15) Spikes, used by the climber as a temporary aid in hanging rigging, must be removed before the tree is used for logging.

(16) Topping trees in windy weather is prohibited.

(17) Topping, rigging-up, or stripping is prohibited when visibility is impaired.

(18) When heel tackle is fastened near the machine, a safety line must be placed in such manner that in case of breakage, lines do not strike the power unit and endanger the operator.

(19) Yarding with more than one unit on any one head spar is prohibited.

(20) The angle between the power unit, the high lead block, and the mainline road must not exceed a square lead on rigged spars. When using portable spars or towers, the location of the machine or position of the operator must ensure that the operator is not endangered by incoming logs.

[Statutory Authority: RCW 49.17.010, 49.17.040, 49.17.050, 49.17.060, and chapter 49.17 RCW. WSR 17-17-131, § 296-54-701, filed 8/22/17, effective 10/22/17. Statutory Authority: RCW 49.17.010, [49.17].040 and [49.17].050. WSR 99-17-117, § 296-54-701, filed 8/18/99, effective 12/1/99.]

WAC 296-54-70110 Wood spar trees—Guylines. (1) Wood spar trees using a line greater than 7/8-inch and used as loading and yarding trees must have at least six top guys and four buckle guys, if a sail guy is used.

(2) Wood spar trees using a mainline greater than 7/8-inch and used only as yarding trees must have at least six top guys and must use at least three buckle guys.

(3) Wood spar trees using a mainline of 7/8-inch or less must be supported by at least five top guylines or other positive means of supporting the spar.

(4) Wood spar trees used for yarding with light equipment (7/8-inch or smaller mainline) must be guyed so that strains will be imposed on at least two guylines. If less than five top guys are used, guylines must be at least 1/4-inch larger than the mainline.

(5) Wood spar trees used for loading only with crotch line, spreader bar, or swinging boom must have at least four top guys and must use at least three buckle guys.

(6) More guylines must be added if there is any doubt about the stability of a spar tree, raised tree, tail tree, lift tree, or other equipment or rigging they support.

(7) Wood spar trees used for transfer must have at least five top guys and must use at least three buckle guys.

(8) Guylines must be alternately passed around the wood spar in opposite directions to prevent twisting of the spar.

(9) Guylines must be attached to the upper portion of the wood spar by shackles.

(10) When a high lead block is hung below buckle guys, at least three top guys of equal strength to the mainline must be used to keep the top from swaying.

(11) When buckle guys are required, they must be installed on the tree where they will provide the maximum effectiveness.

[Statutory Authority: RCW 49.17.010, 49.17.040, 49.17.050, 49.17.060, and chapter 49.17 RCW. WSR 17-17-131, § 296-54-70110, filed 8/22/17, effective 10/22/17. Statutory Authority: RCW 49.17.010, [49.17].040 and [49.17].050. WSR 99-17-117, § 296-54-70110, filed 8/18/99, effective 12/1/99.]

WAC 296-54-70120 Wood spar trees—Passlines. All spar trees must be equipped with passlines that are:

(1) At least 5/16-inch and a maximum of 1/2-inch in diameter;

- (2) Not subjected to sawing on other lines or rigging, and are kept clear of all moving lines and rigging;
- (3) A continuous length and in good condition with no splices, knots, molles, or eye-to-eye splices between the ends; and
- (4) Long enough to provide three wraps on the drum before the climber leaves the ground.

[Statutory Authority: RCW 49.17.010, [49.17].040 and [49.17].050. WSR 99-17-117, § 296-54-70120, filed 8/18/99, effective 12/1/99.]

WAC 296-54-70130 Wood spar trees—Straps. (1) Safety straps of appropriate size must be placed on all high lead blocks; and other blocks whenever practicable. Safety straps must be shackled (with the closed end of the shackle up) to a guyline that extends as near as possible at right angles with the power unit, but must not be on a guyline with an extension within one hundred feet of the tree. When the top guyline on which the safety strap of the high lead block is fastened is changed, the safety strap must be attached to another guyline or the loosened guyline must be tightened after the change.

(2) All tree straps must be at least 1/4-inch larger than the pulling line. If impossible to use a safety strap, all tree straps must be 1/2-inch larger than the pulling line.

(3) Lead blocks used for yarding, swinging, loading, and unloading used in wood spars must be:

(a) Designed and constructed for this purpose;

(b) Bolted with at least two bolts through the shells below the sheaves in a manner that will retain the sheave and line in case of bearing pin failure (this does not apply to haulback lead blocks); and

(c) Mainline blocks have a sheave diameter of at least twenty times the diameter of the mainline.

[Statutory Authority: RCW 49.17.010, [49.17].040 and [49.17].050. WSR 99-17-117, § 296-54-70130, filed 8/18/99, effective 12/1/99.]

WAC 296-54-705 Truck and equipment maintenance shops. It is recognized that the usual hazards encountered in maintenance shops performing work on logging and related equipment would be very similar to those found in general repair, machine or welding shops; therefore, the rules contained in chapter 296-24 WAC, General safety and health standards and other applicable safety standards promulgated and administered by the department of labor and industries must apply to such places of work.

[Statutory Authority: RCW 49.17.010, 49.17.040, 49.17.050, 49.17.060, and chapter 49.17 RCW. WSR 17-17-131, § 296-54-705, filed 8/22/17, effective 10/22/17. Statutory Authority: RCW 49.17.010, [49.17].040 and [49.17].050. WSR 99-17-117, § 296-54-705, filed 8/18/99, effective 12/1/99.]

WAC 296-54-707 Labor camps. Temporary labor camps for logging operations must meet the requirements of chapter 296-833 WAC, Temporary housing for workers.

[Statutory Authority: RCW 49.17.010, 49.17.040, 49.17.050, 49.17.060. WSR 07-03-163, § 296-54-707, filed 1/24/07, effective 4/1/07. Statutory Authority: RCW 49.17.010, [49.17].040 and [49.17].050. WSR 99-17-117, § 296-54-707, filed 8/18/99, effective 12/1/99.]

WAC 296-54-99002 Appendix 1—Signals.

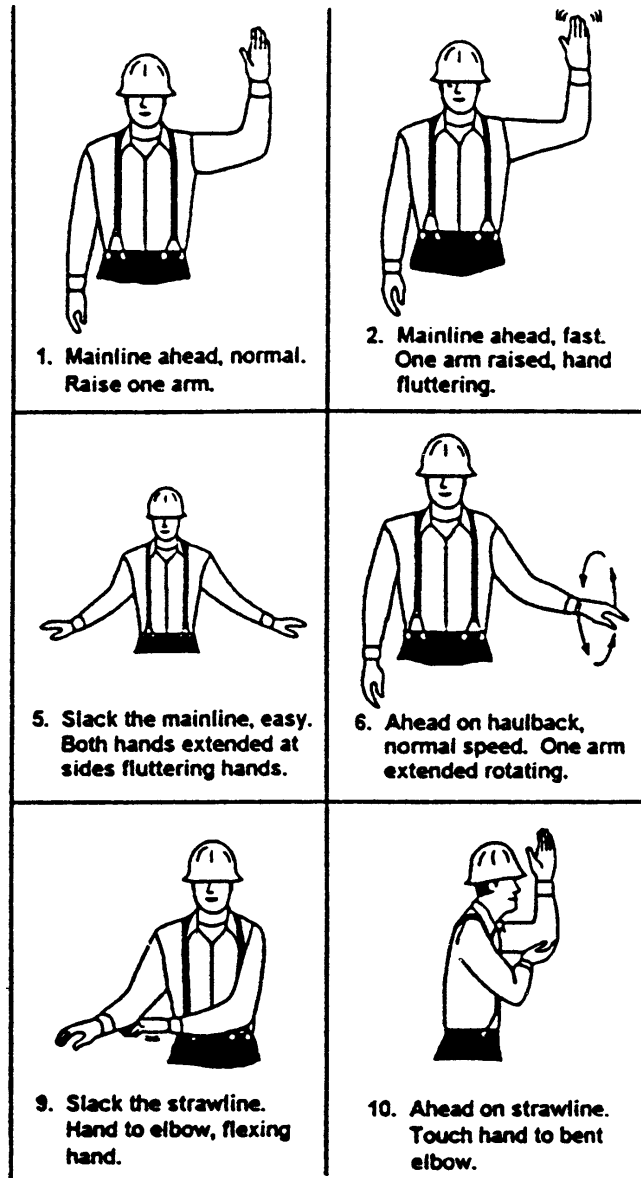

Figure 39: Standard Hand Signals

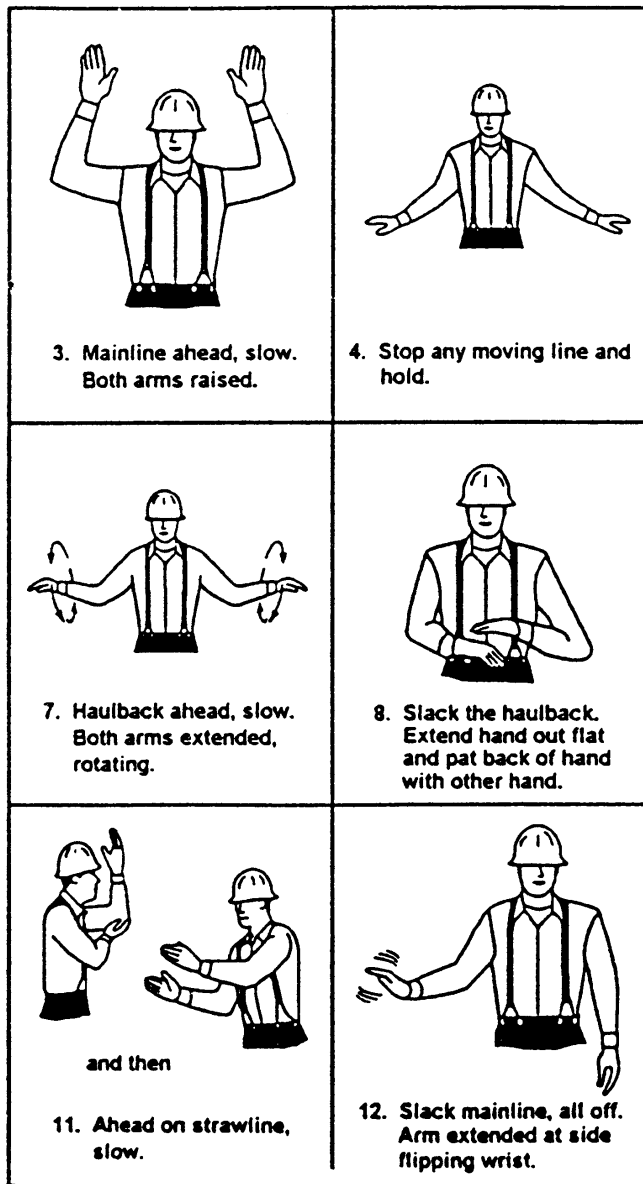

Figure 40: Standard Hand Signals

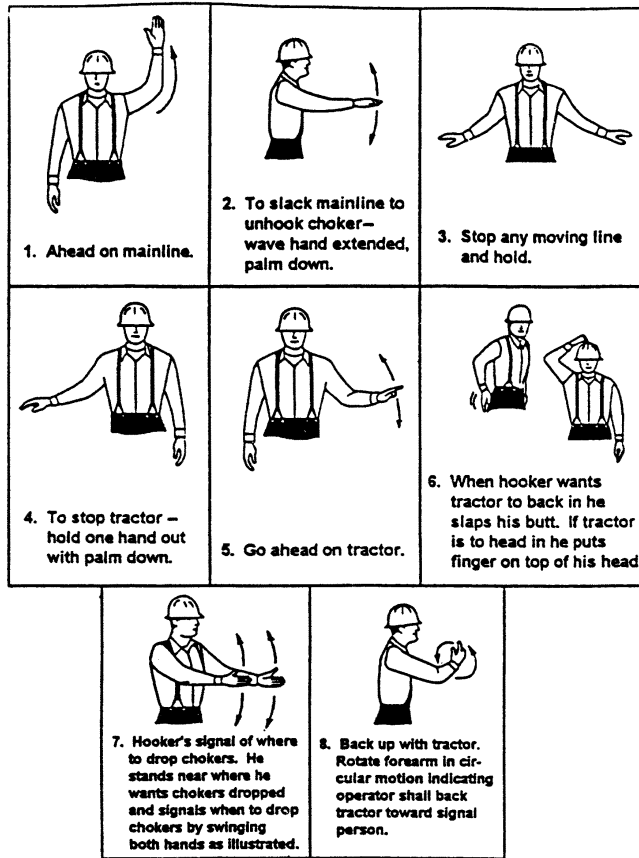

Figure 41: Standard Hand Signals

STANDARD SIGNALS FOR LOADING LOGS



Figure 42: Standard Signals for Loading Logs

HIGH LEAD LOGGING WHISTLE SIGNALS
 - Means longer spacing between signals.

1 short	Stop all lines.
3 short-3 short	Ahead slow on mainline.
3 short	Ahead on mainline.
2 short	Ahead on haulback.
2 short-2 short	Ahead slow on haulback.
3 short-1 short	Ahead on strawline.
3 short-1 short-3 short	Ahead slow on strawline.
4 short or more	Slack mainline.
2 short-4 short	Slack haulback.
3 short-1 short-4 short	Slack strawline.
3 short-2 short	Standing tight line.
1 short-1 short	Tight line while lines are running, or break if running tight.
3 short	When rigging is in: Strawline back on haulback.
3 short / plus "X" number of shorts	When rigging is in: Indicates number of sections of strawline back on rigging.
3 short-1 short-2 short	Strawline back on rigging.

**HIGH LEAD LOGGING WHISTLE SIGNALS
- Means longer spacing between signals.**

1 short	When rigging is in: Chaser inspect and repair rigging.
2 short	When rigging is in: No chokers back.
2 short-1 short / plus "X" number of shorts	Number of chokers back.
2 short-4 short	When rigging is in: Slack haulback-hold all lines until 2 short blown.
3 medium	Hooker.
3 medium-4 short	Hooker and that crew.
5 long	Climber.
4 long	Foreman.
1 long-1 short	Start or stop work.
7 long-2 short	Person injured, call transportation and stretcher.
1 long-1 short repeated	Fire.
Grabinski system	
2 short-1 short	Slack mainline and haulback together.
2 long	Take off or put on rider block.

**SKIDDER WHISTLE SIGNALS
- Means longer spacing between signals.**

1 short	Stops moving carriage-stops or goes ahead on slack puller, as case may be, if carriage is stopped.
2 short	Go ahead on skidding line holding carriage.
1 short-2 short	Pick up skidding line, easy.
2 short-1 short	Shake up carriage to clear choker.
2 short-2 short	Ahead on receding line.
3 short	Ahead on carriage, holding at present level, using interlock.
3 short-3 short	Ahead easy on skidding line.
2 short-2 short-2 short	Slack skyline, cable down.
2 short-2 short-2 short-1 short	Pick up skyline, cable up.
2 short-2 short-4 short	Slack receding line.
2 short-4 short	Slack skidding line.
2 short-2 short-1 short	Tighten all lines.
1 short-4 short	Slack off slack puller.
1 short-2 short	Pick up slack puller when slack.

SKIDDER WHISTLE SIGNALS
- Means longer spacing between signals.

2 short-2 short / plus "X" number of shorts	When carriage is in: Number of chokers wanted.
2 short-2 short-1 long 1 short	Bull choker. When carriage is in: Inspect butt rigging.
2 short-4 short / 1 short	For each additional ten feet of tong line.
1 long / plus "X" number of shorts	Number of coils of strawline wanted.
5 medium	Tail or second rigger.
5 medium-4 short	Tail or second rigger and that crew.
2 medium	Skidder head rigger.
3 medium-4 short	Hooker and that crew.
2 long	Ahead on transfer.
2 long-4 short	Slack transfer.
1 short-3 short	Ahead on carriage with slack puller line.
1 long	Ahead on strawline.
1 long-4 short	Slack strawline.
1 long-3 short	Ahead easy on strawline.
5 long	Climber.
4 long	Foreman.
1 long-1 short	Start or stop work.
7 long-2 short	Person injured, call transportation and stretcher.
1 long-1 short repeated	Fire.

SLACKLINE WHISTLE SIGNALS
- Means longer spacing between signals.

2 short-2 short-2 short-1 short	First cable up when road has been changed and tail hold made fast.
2 short-2 short-2 short 1 short	Drop skyline. Stop any moving line.
1 long	When logging, slack skyline.
2 short	Ahead on skyline.
1 long-2 short	Ahead easy on skyline.
3 short	Ahead on skidding line, holding haulback.
3 short-3 short	Ahead easy on skidding line with slack haulback.
4 short	Slack skidding line.
2 short-2 short / 2 short-2 short	Ahead easy on haulback with slack skidding line.
2 short-2 short	Ahead on haulback.
2 short-2 short-4 short	Slack haulback.
2 short / 3 short	Pick up skyline and skid.

**SLACKLINE WHISTLE SIGNALS
- Means longer spacing between signals.**

2 short / 2 short-2 short	Pick up skyline and skin.
3 short-1 short	When carriage is in: Strawline back on haulback.
3 short-1 short-2 short	When carriage is in: Strawline back on carriage.
3 short-1 short	When strawline is out: Ahead on strawline.
3 short-2 short	Tight line.
3 short-1 short-4 short	Slack strawline.
3 short-1 short-3 short	Pull easy on strawline.
2 long	Ahead on transfer.
2 long-4 short	Slack transfer.
2 long-2 short-2 short	When carriage is in: Transfer back on carriage.
1 long / plus "X" number of shorts	When carriage is in: Number of coils.
2 short-2 short-1 short / plus "X" number of shorts	When carriage is in: Number of chokers.
1 short	When carriage is in: Inspect rigging, repair and send back.
2 short-2 short-4 short	When carriage is in: Slack haulback and hold all lines until 1 short is blown-then send back.
3 short-3 short	When carriage is in: Send back powder.
5 medium	Tail rigger.
5 medium-4 short	Tail rigger and that crew.
3 medium	Head hooker.
3 medium-4 short	Second hooker and that crew.
5 long	Climber.
4 long	Foreman.
1 long-1 short	Start or stop work.
7 long-2 short	Person injured, call transportation and stretcher.
1 long-1 short repeated	Fire.

**RUNNING SKYLINE WHISTLE SIGNALS
- Means longer spacing between signals.**

1 short	Stop all moving lines.
2 short	Skin carriage back.
2 short-1 short	Slack haulback.
2 short-2 short	Skin carriage easy.
2 short-3 short	Standing tight line.
1 short-2 short	Ahead on drop line.
4 short	Slack drop line.

**RUNNING SKYLINE WHISTLE SIGNALS
- Means longer spacing between signals.**

1 short-4 short	Slack both mainlines.
1 short-1 short	Stop drop line going up and move carriage forward.
3 short	Move carriage forward.
3 short-3 short	Move carriage forward easy.
3 short-1 short	When strawline is out: Ahead on strawline.
3 short-1 short-4 short	Slack strawline.
3 short	When carriage is in: Strawline.
3 short-X short	When carriage is in: Number sections.
3 short-1 short-2 short	When carriage is in: Strawline back on carriage.
2 short-X short	When carriage is in: Number of chokers.
4 short	When carriage is in: Inspect rigging, repair and send back.
1 short	When carriage is in: Hold all lines until 2 shorts, then send back.
3 medium	Head hooker.
3 medium-4 short	Hooker and that crew.
4 long	Foreman.
1 long-1 short	Start or stop work.
7 long-2 short	Person injured; call transportation and stretcher.
1 long-1 short (repeated)	Fire.
3 short-1 long	Acknowledged by engineer to signify hazardous turn.

TENSION SYSTEM SIGNALS

4	Release tension.
1 short	Stop carriage and start unspooling tong line.
1 short	Stop tong line.
1 short	Resume unspooling tong line.
1 short	Will stop any moving line or slack tong line when carriage is stopped.
2 short-2 short	Go into interlock and go back.
2 short-4 short	Slack haulback and let carriage down.
After turn is set 2 short	Go ahead on tong line.

TENSION SYSTEM SIGNALS

2 short-3 short	Go ahead easy on tong line.
3 short	Go into interlock and take carriage to landing.
3 short-3 short	Ahead on carriage easy.
1 short-2 short	Increase tension on tong line when carriage is going in.
short-1 short	Decrease tension on tong line when carriage is going in.

[Statutory Authority: RCW 49.17.010, [49.17].040 and [49.17].050. WSR 99-17-117, § 296-54-99002, filed 8/18/99, effective 12/1/99; Order 72-14, Figure 2 (codified as WAC 296-54-99002), filed 7/31/72, effective 9/1/72.]

WAC 296-54-99003 Appendix 2—Sample minimum lockout/tagout procedure. (Company Name) has established this lockout/tagout program to provide protection for employees performing maintenance or servicing of equipment.

Before any employee begins maintenance or servicing of equipment where the unexpected energizing, start up, or release of stored energy could cause injury, the equipment must be shut down, isolated from all potentially hazardous energy and locked or tagged out.

Employees must not start, attempt to start, energize or use equipment that has been locked or tagged out. Tags and/or padlocks will be provided for tagging and/or locking out machinery and will be durable enough to withstand the environment. Tags will contain a legend such as: "Do Not Start" or "Do Not Operate." When tagout is used, tags must be located in a position that will be obvious to anyone attempting to operate the machinery. In lockout, padlocks are commonly used to prevent access to ignition/master switches or battery disconnects.

Employees performing maintenance or servicing must determine which sources of hazardous energy must be disabled for a particular job. The following are examples of hazardous stored energy found on equipment:

1. Equipment
2. Hydraulic or pneumatic pressure
3. Mechanical (rotating saws, springs, shafts, gears, etc.)
4. Gravity (elevated blades, booms, grapples, saw heads, etc.)

Sample lockout/tagout procedures

The following steps must be followed for lockout/tagout:

1. Ensure that the brakes, swing locks, etc. are applied.
2. Place the transmission in the manufacturer's specified park position.
3. Lower or secure each moving element such as, but not limited to, blades, booms, grapples, buckets, saws, and shears to prevent a release of stored energy.
4. Shut down machinery, and ensure that a responsible person removes and keeps the ignition/master key.
5. Engage hydraulic safety locks when applicable.

6. Before working on hydraulic or air systems, relieve pressure by bleeding tanks or lines and operate controls to dissipate residual stored energy (pressure).

7. Place lockout and/or tagout device.

Before lockout or tagout devices are removed and machinery is started, inspect the work area to ensure all tools have been removed, guards are replaced, and employees are in the clear.

We will provide training to ensure that the purpose and function of the lockout/tagout program are understood by employees performing maintenance or repair of equipment.

[Statutory Authority: RCW 49.17.010, 49.17.040, 49.17.050, 49.17.060, and chapter 49.17 RCW. WSR 17-17-131, § 296-54-99003, filed 8/22/17, effective 10/22/17. Statutory Authority: RCW 49.17.010, [49.17].040 and [49.17].050. WSR 99-17-117, § 296-54-99003, filed 8/18/99, effective 12/1/99; Order 72-14, Figure 3 (codified as WAC 296-54-99003), filed 7/31/72, effective 9/1/72.]

WAC 296-54-99004 Appendix 3—Industry consensus standards.

American Society of Mechanical Engineers
ASME
345 East 47th Street
New York, NY 10017
(212) 591-7000

Society of Automotive Engineers, Incorporated
SAE
400 Commonwealth Drive
Warrendale, PA 15096-0001
(412) 776-4841

American National Standards Institute
11 West 42nd Street
New York, NY 10036
(212) 642-4900

Occupational Safety and Health Administration's Office of Publications

OSHA
Room N 3101, 200 Constitution Avenue Northwest
Washington, DC 20210
(202) 219-4667

[Statutory Authority: RCW 49.17.010, [49.17].040 and [49.17].050. WSR 99-17-117, § 296-54-99004, filed 8/18/99, effective 12/1/99; Order 72-14, Figure 4 (codified as WAC 296-54-99004), filed 7/31/72, effective 9/1/72.]

WAC 296-54-99013 Appendix 4—Various types of cable logging systems.

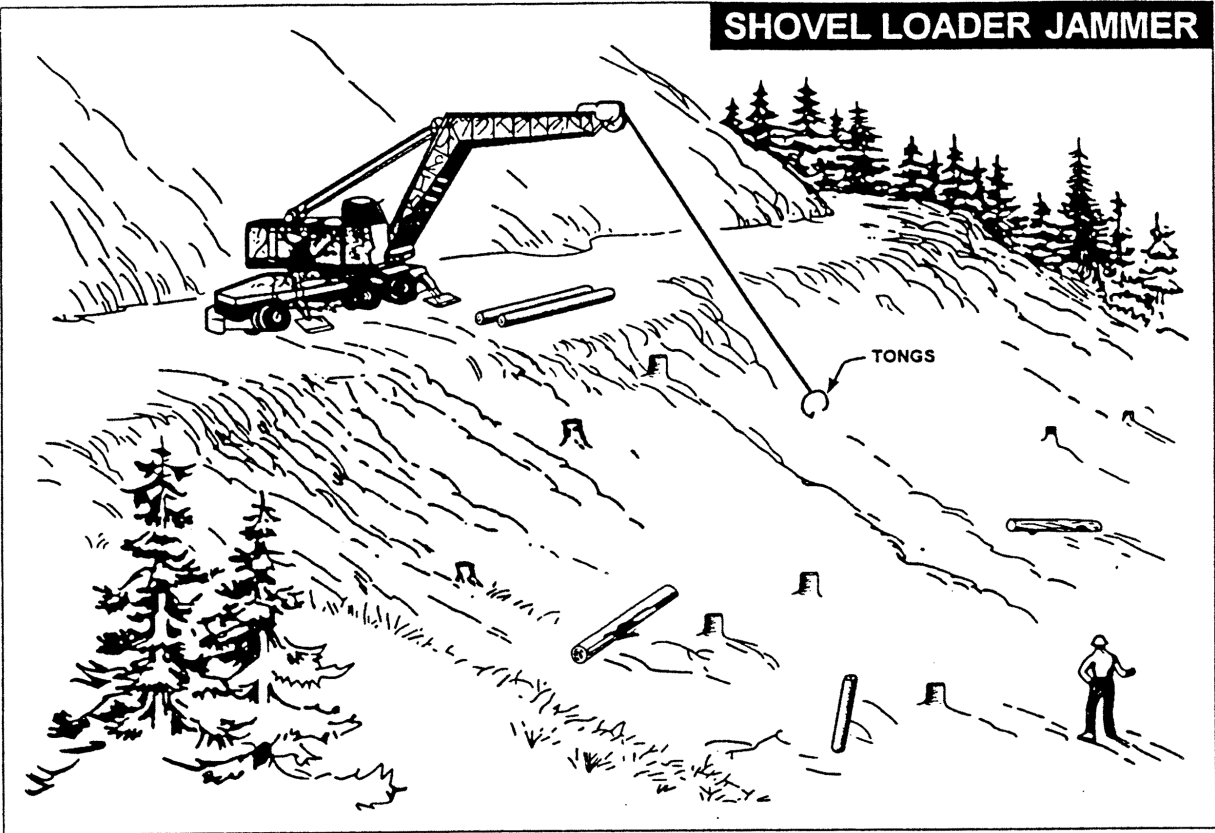

Figure 43: Shovel Load Jammer

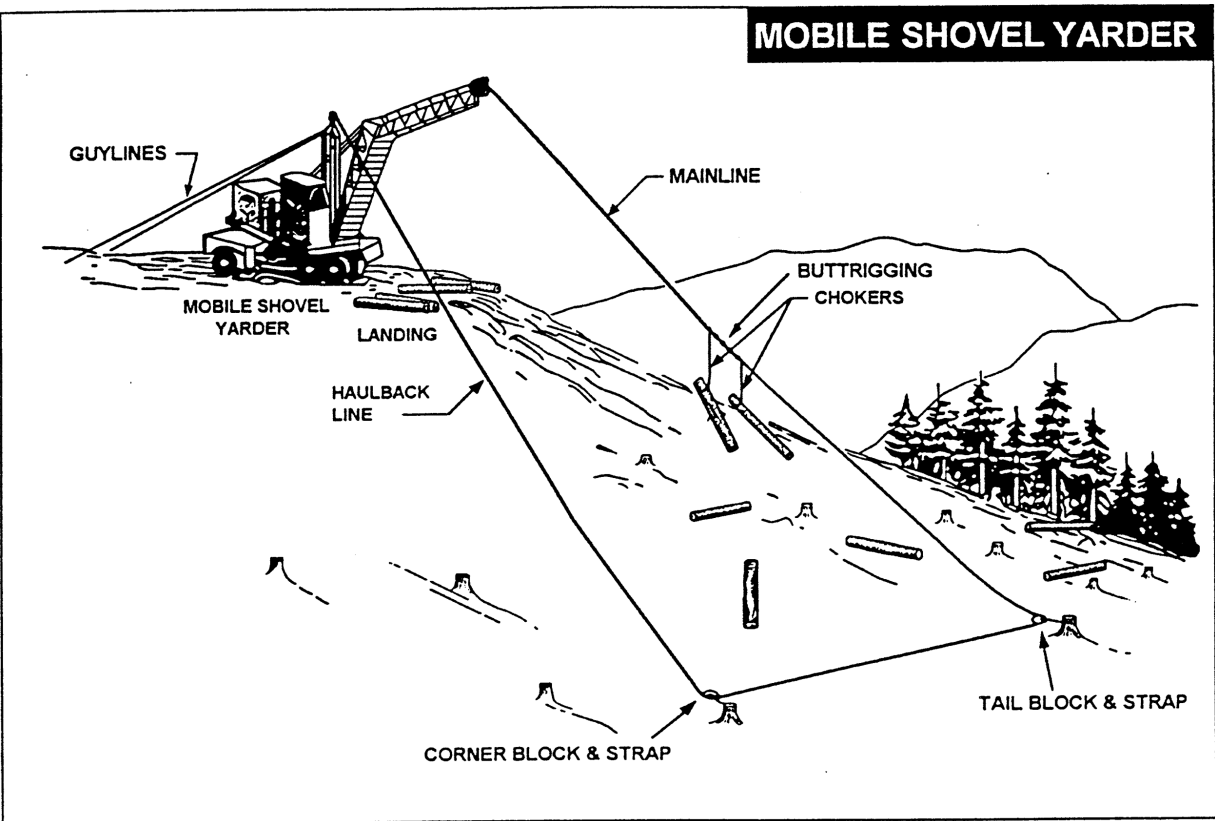

Figure 44: Mobile Shovel Yarder

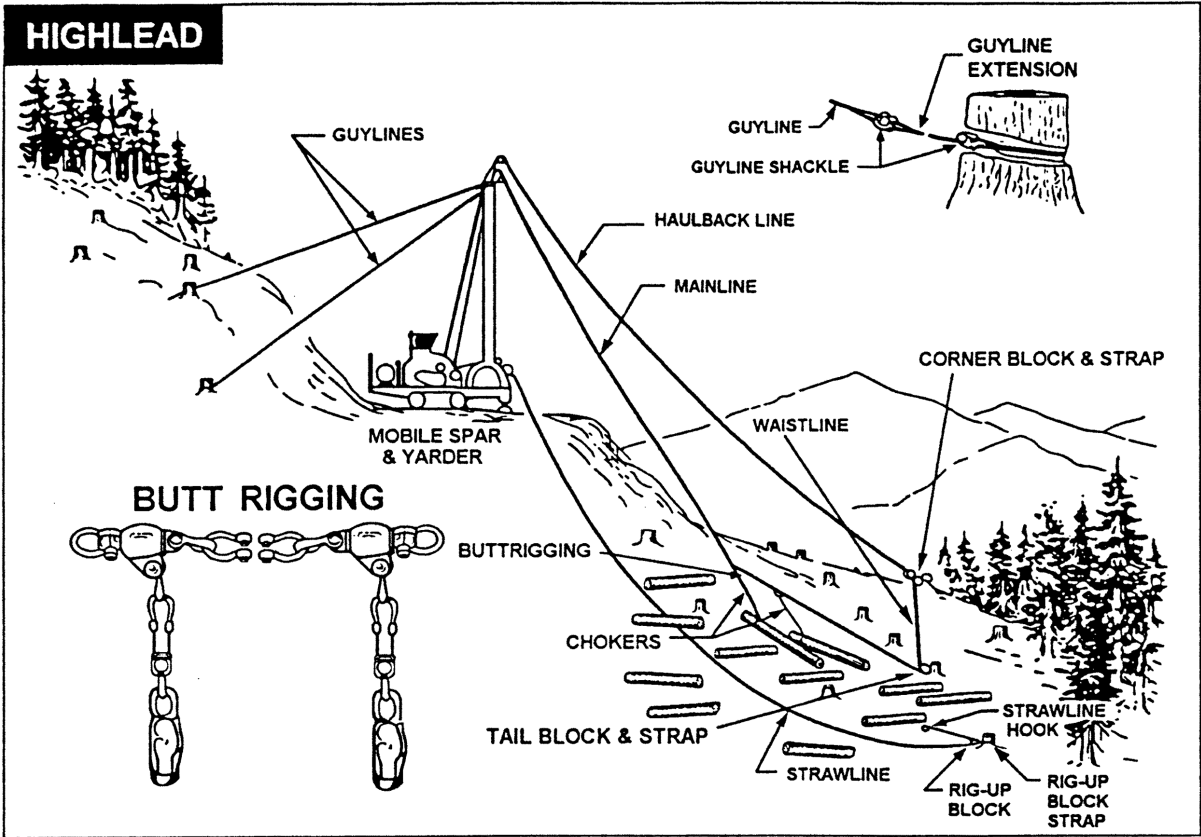

Figure 45: Highlead

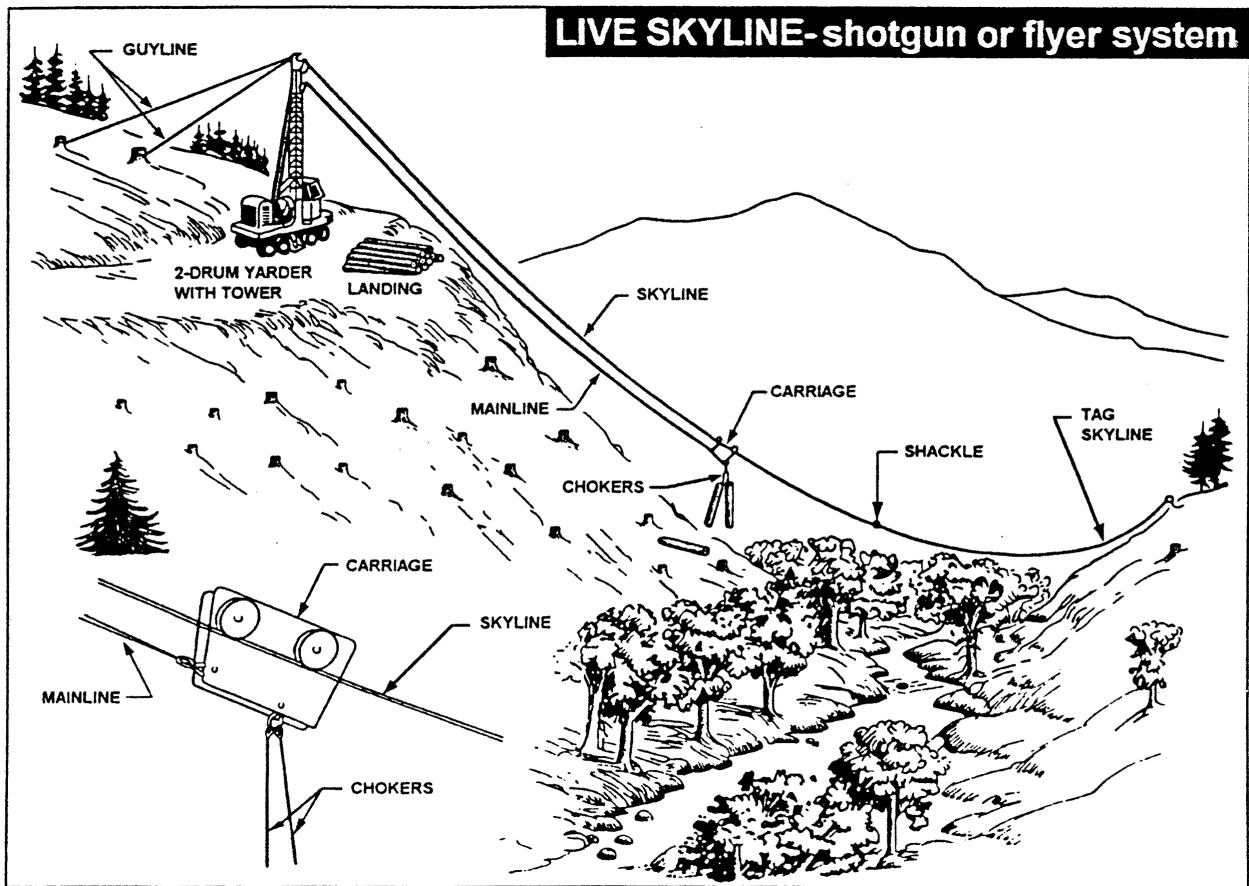

Figure 46: Live Skyline - Shotgun or Flyer System

SLACK LINE SYSTEM

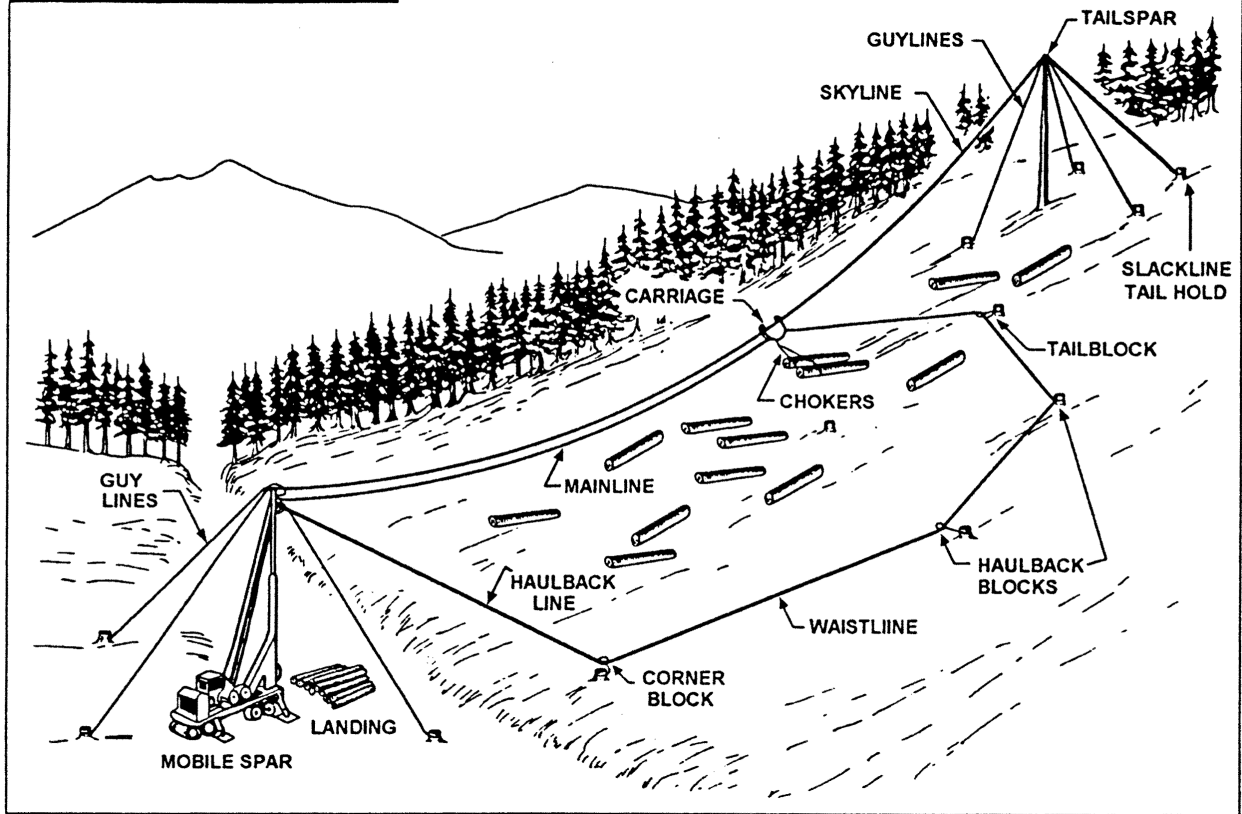

Figure 47: Slack Line System

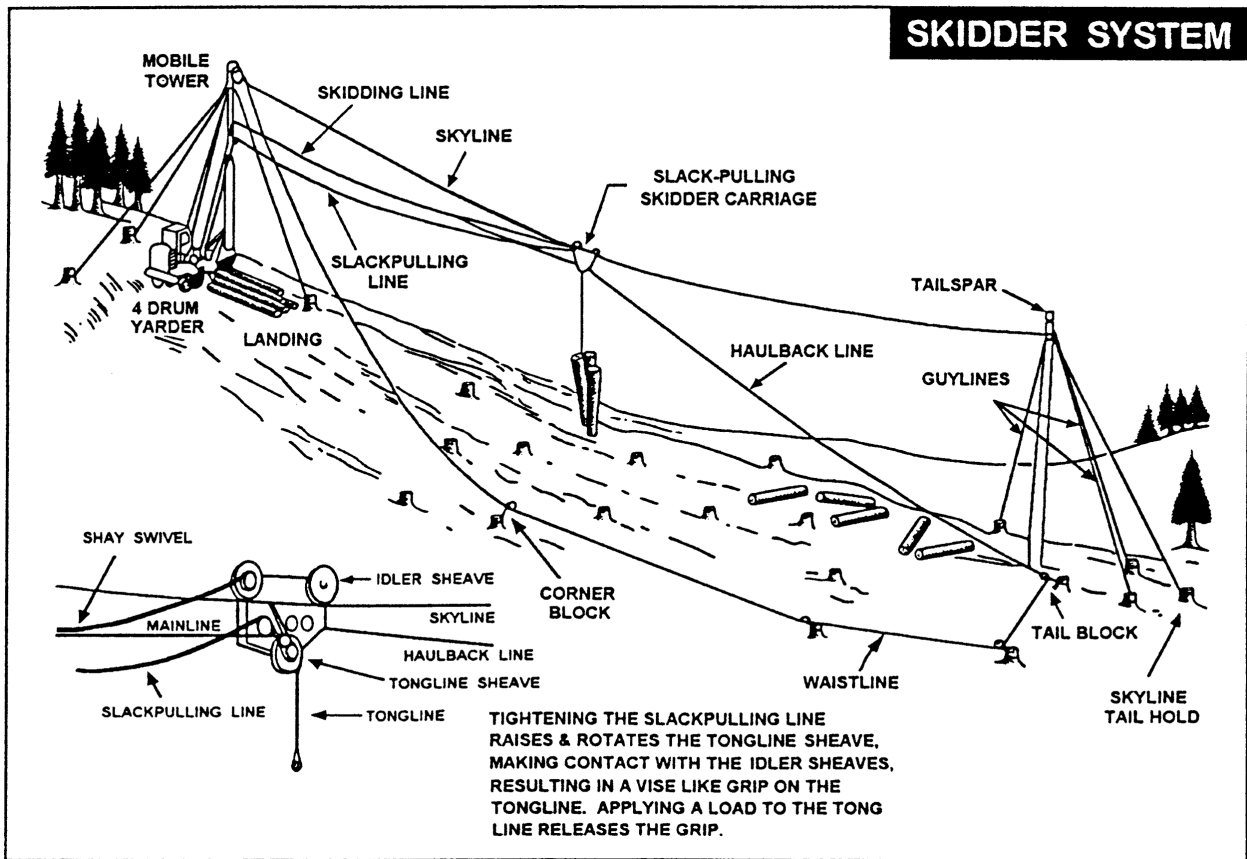

Figure 48: Skidder System

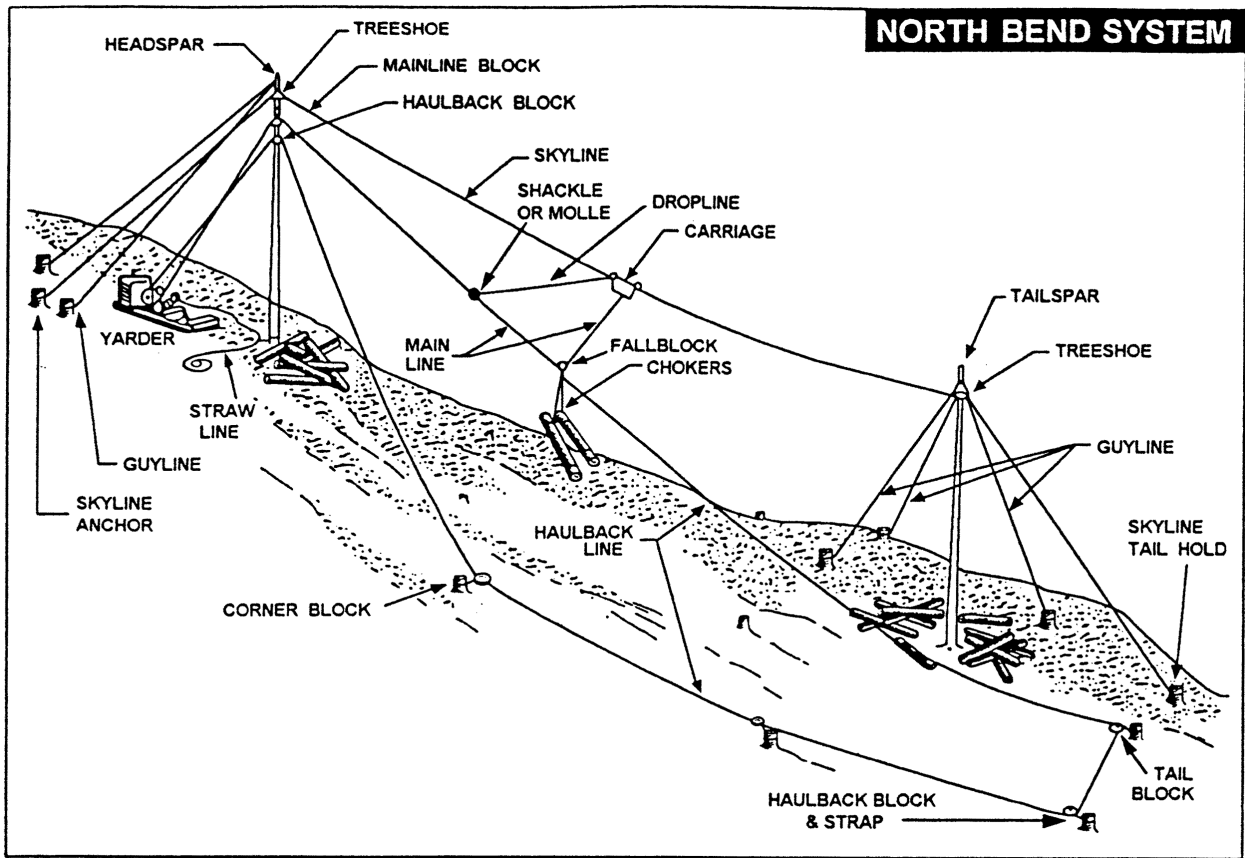

Figure 49: North Bend System

SOUTH BEND SYSTEM

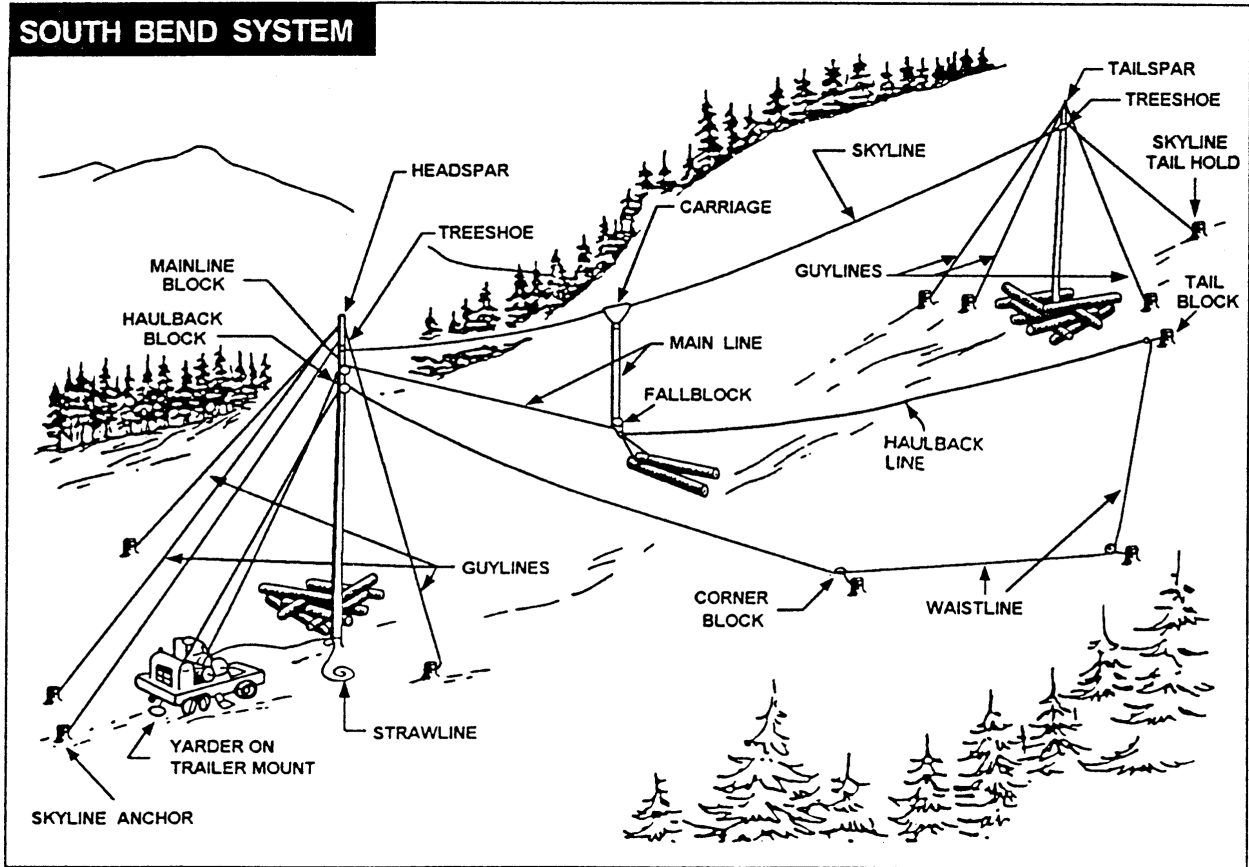

Figure 50: South Bend System

STANDING SKYLINE - RADIO CONTROLLED CARRIAGE

mobile tower

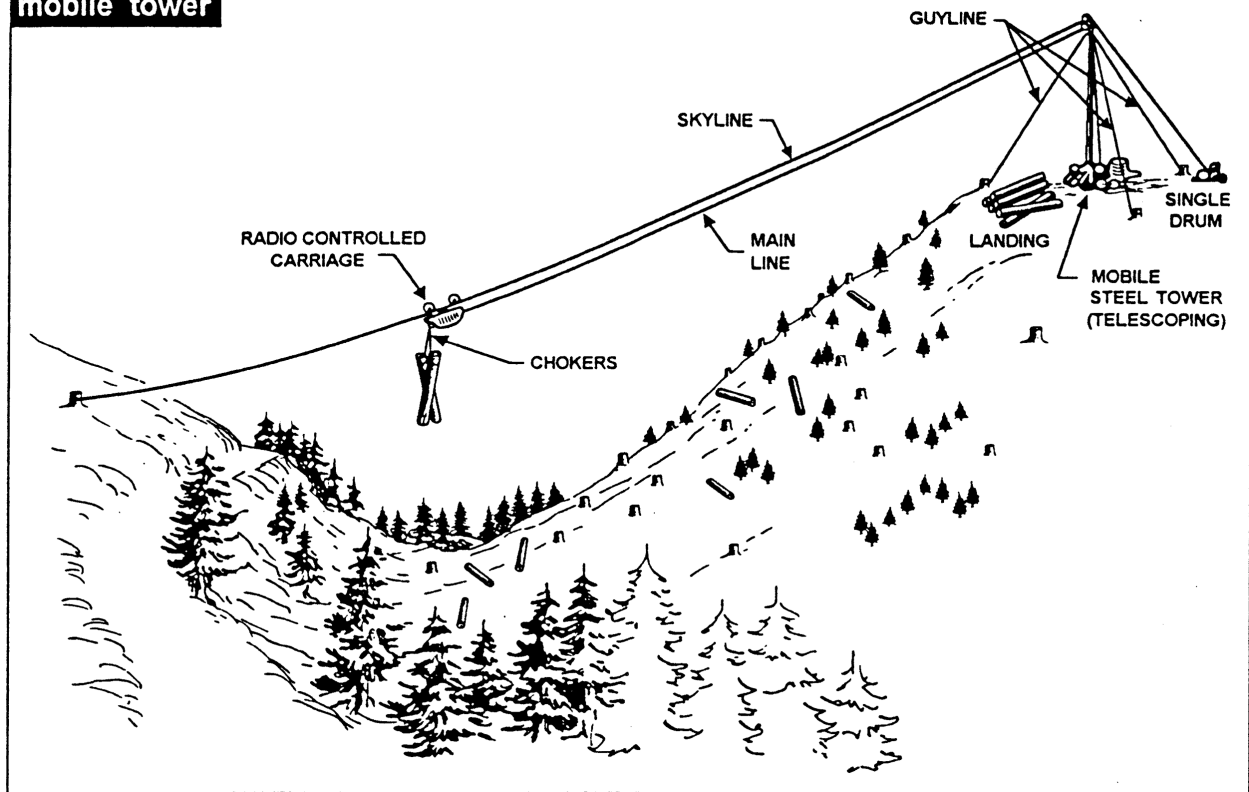

Figure 51: Standing Skyline - Radio Controlled Carriage - Mobile Tower

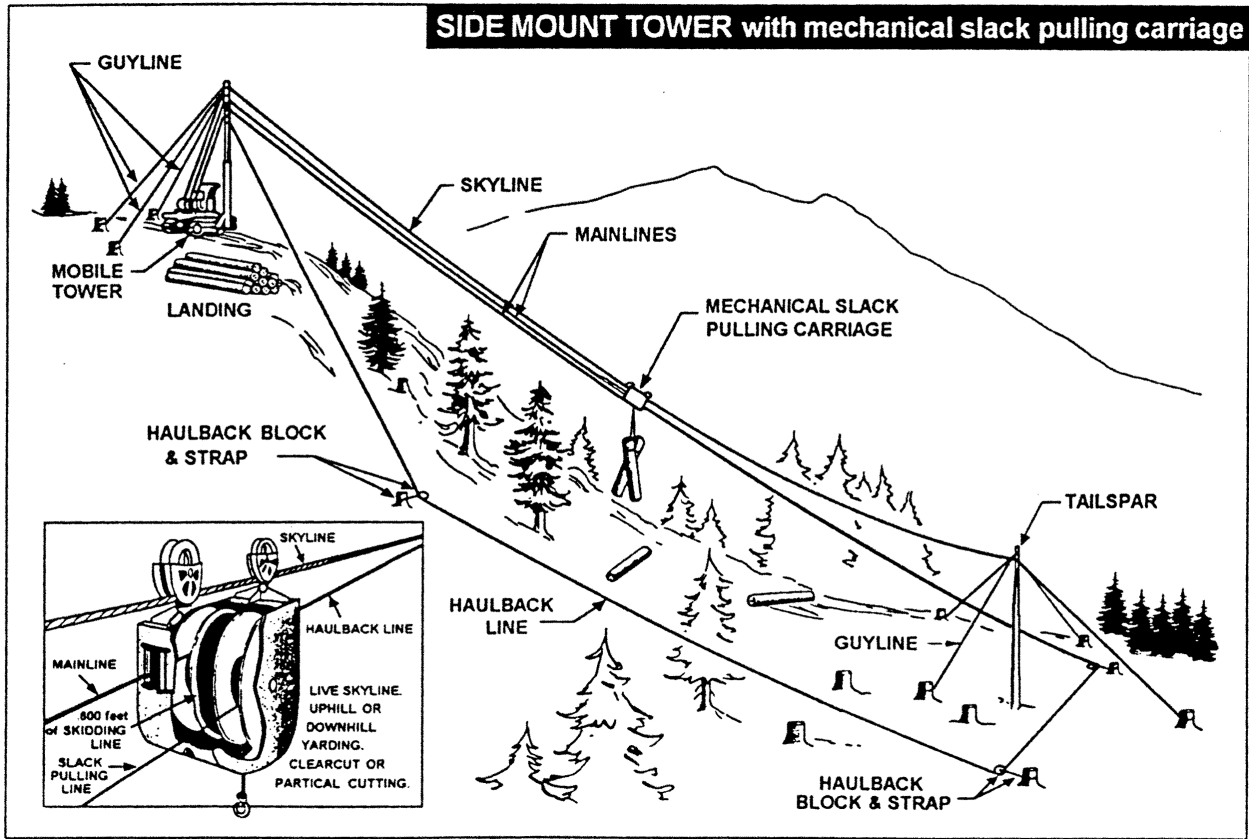

Figure 52: Side Mount Tower with Mechanical Slack Pulling Carriage

PARTIAL CUTTING WITH RUNNING SKYLINE

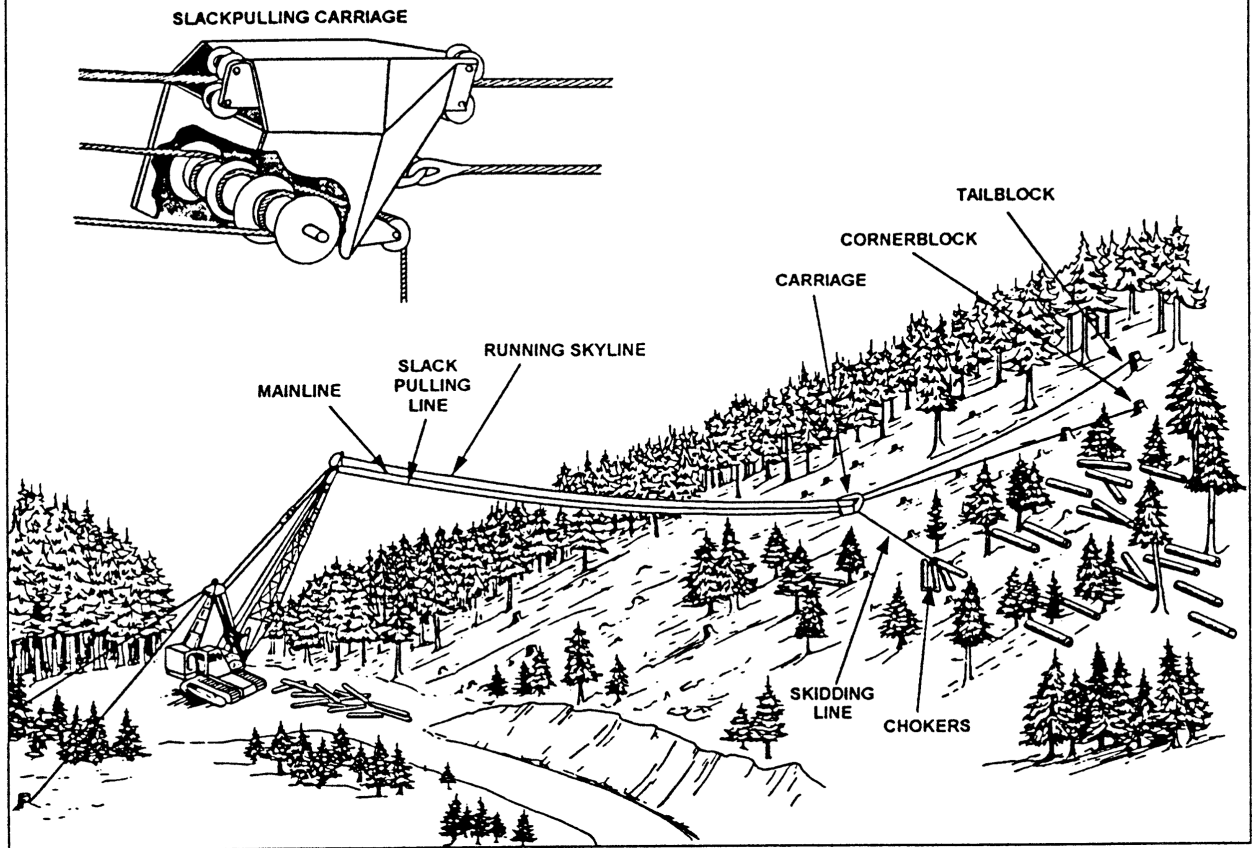

Figure 53: Partial Cutting with Running Skyline

RUNNING SKYLINE with chokers (GRABINSKI)

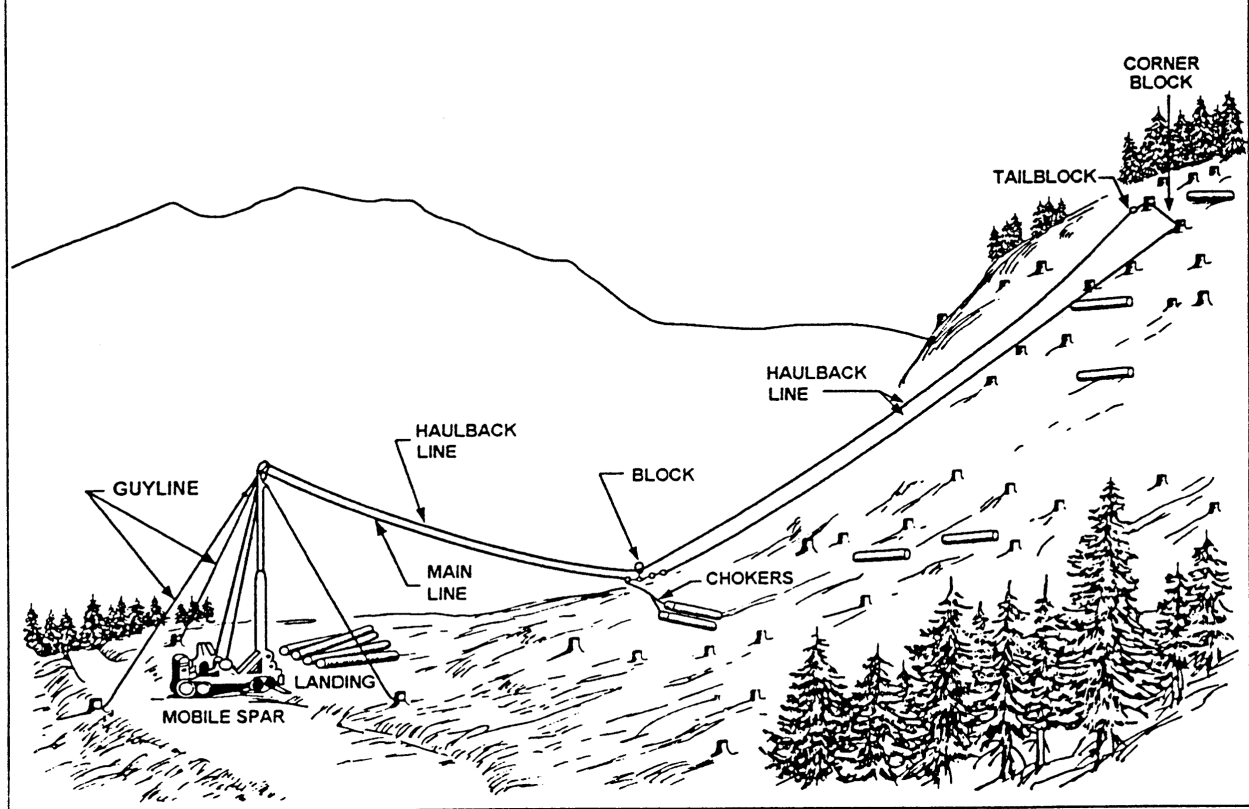

Figure 54: Running Skyline with Chokers (Grabinski)

RUNNING SKYLINE with mechanical grapple

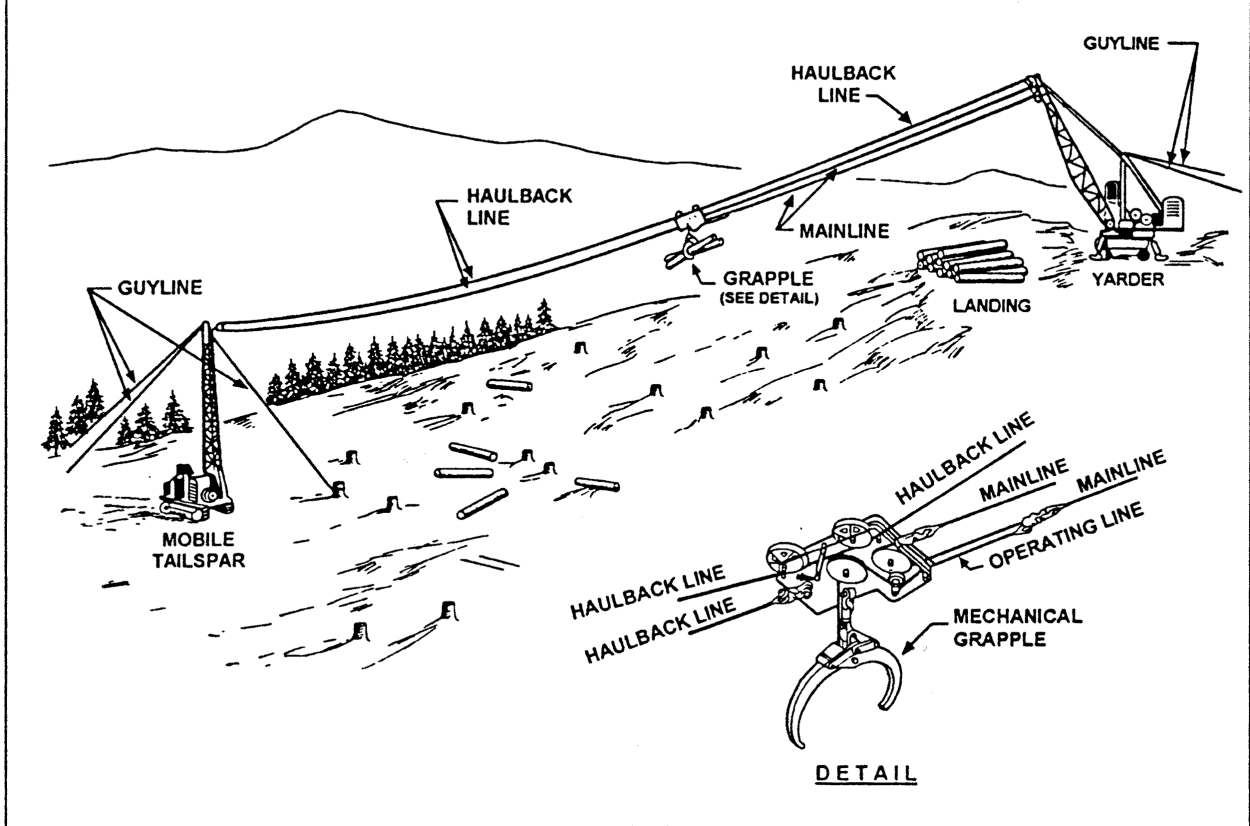

Figure 55: Running Skyline with Mechanical Grapple

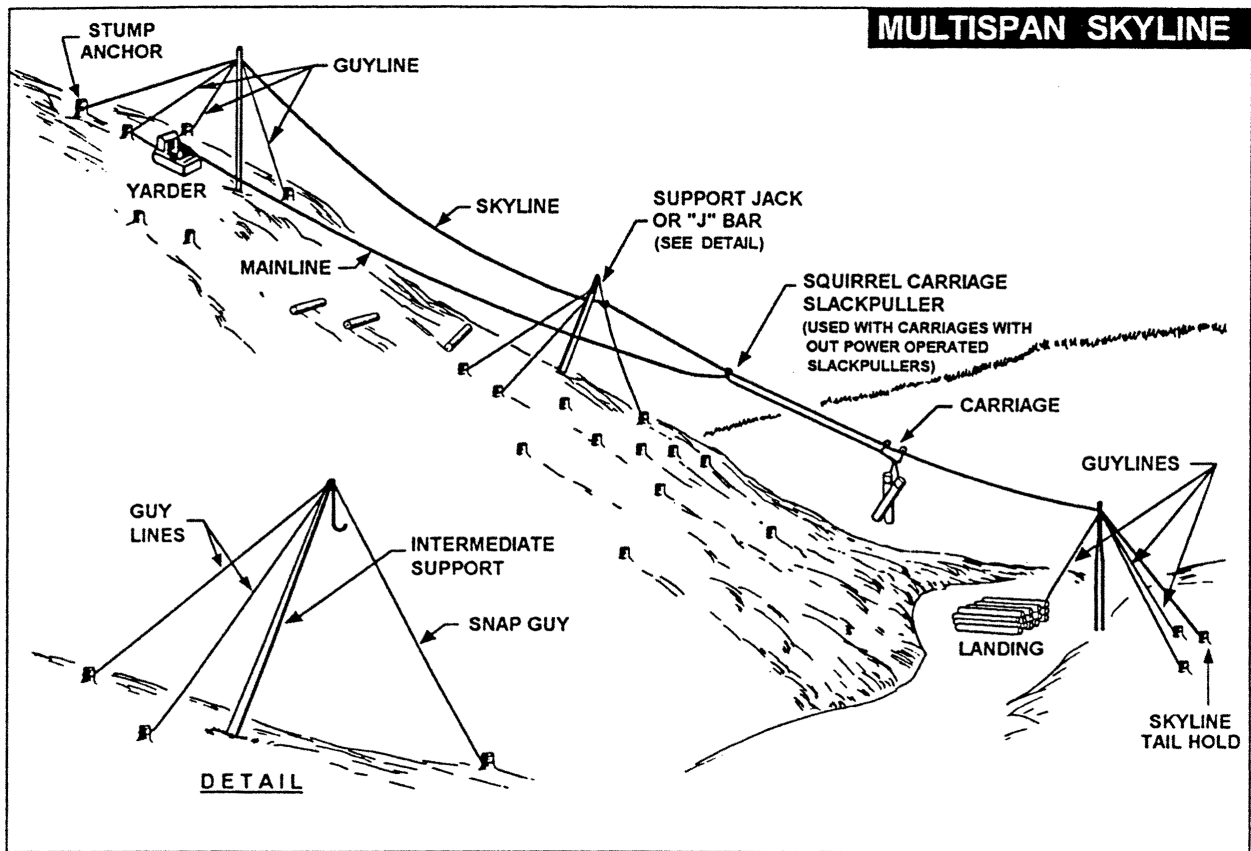

Figure 56: Multi-span Skyline

BALLOON LOGGING - inverted skyline configuration

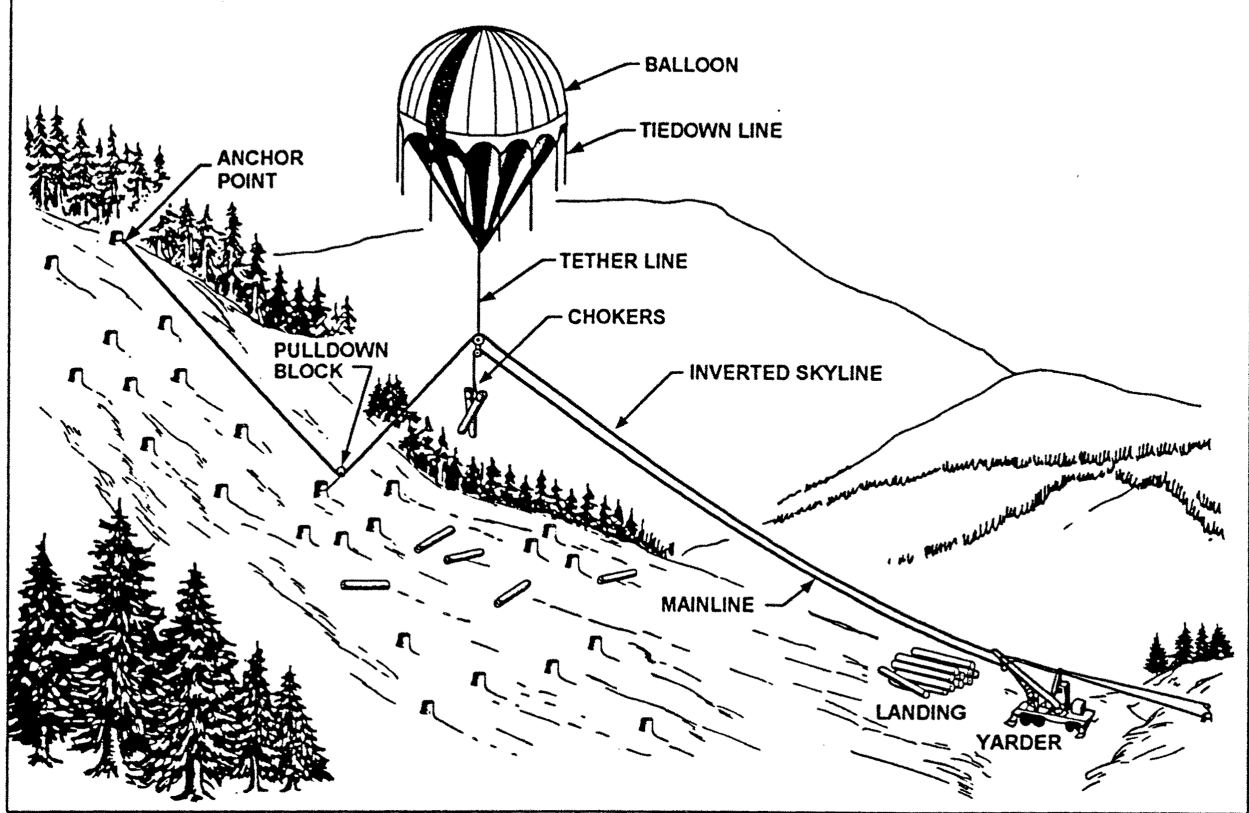

Figure 57: Balloon Logging - Inverted Skyline Configuration

BALLOON LOGGING - haulback configuration

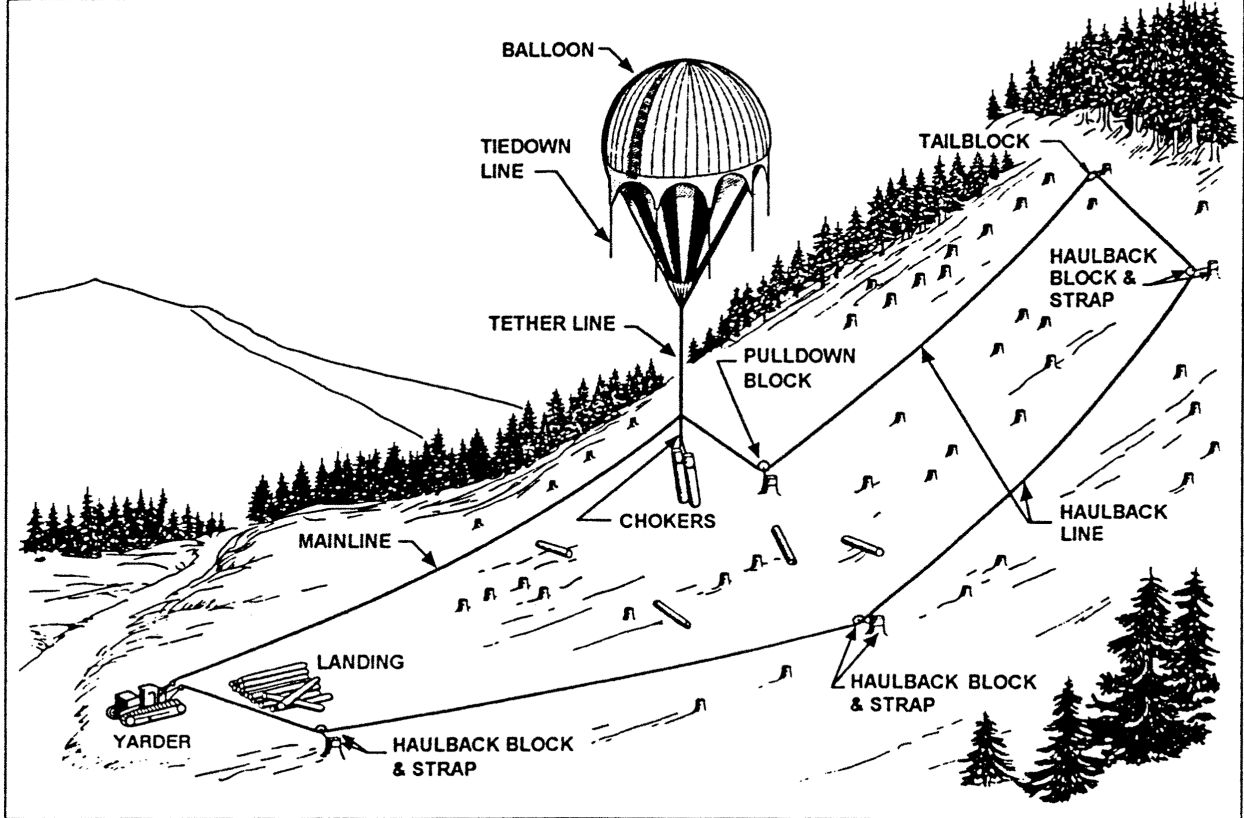

Figure 58: Balloon Logging - Haulback Configuration

[Statutory Authority: RCW 49.17.010, [49.17].040 and [49.17].050. WSR 99-17-117, § 296-54-99013, filed 8/18/99, effective 12/1/99.]

WAC 296-54-99014 Appendix 5—Wooden tree yarding and loading systems.

HIGH LEAD YARDING SYSTEM

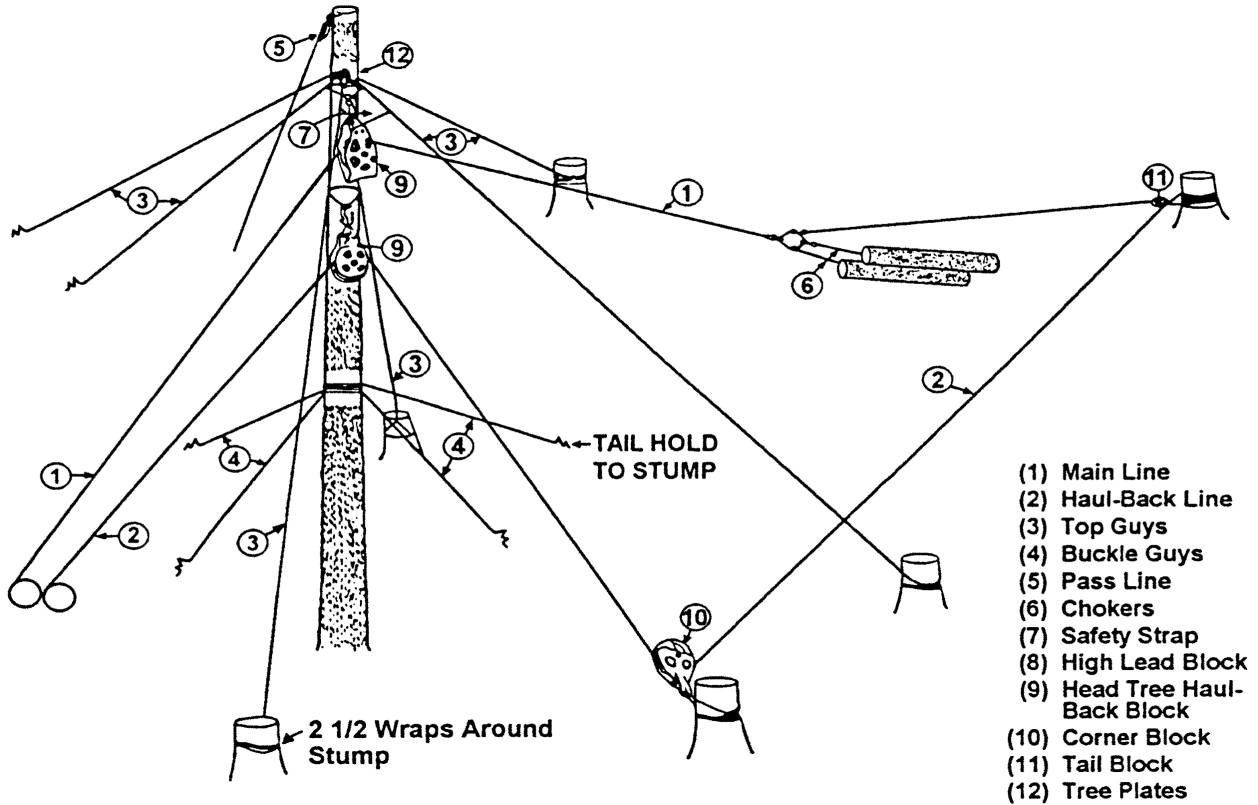
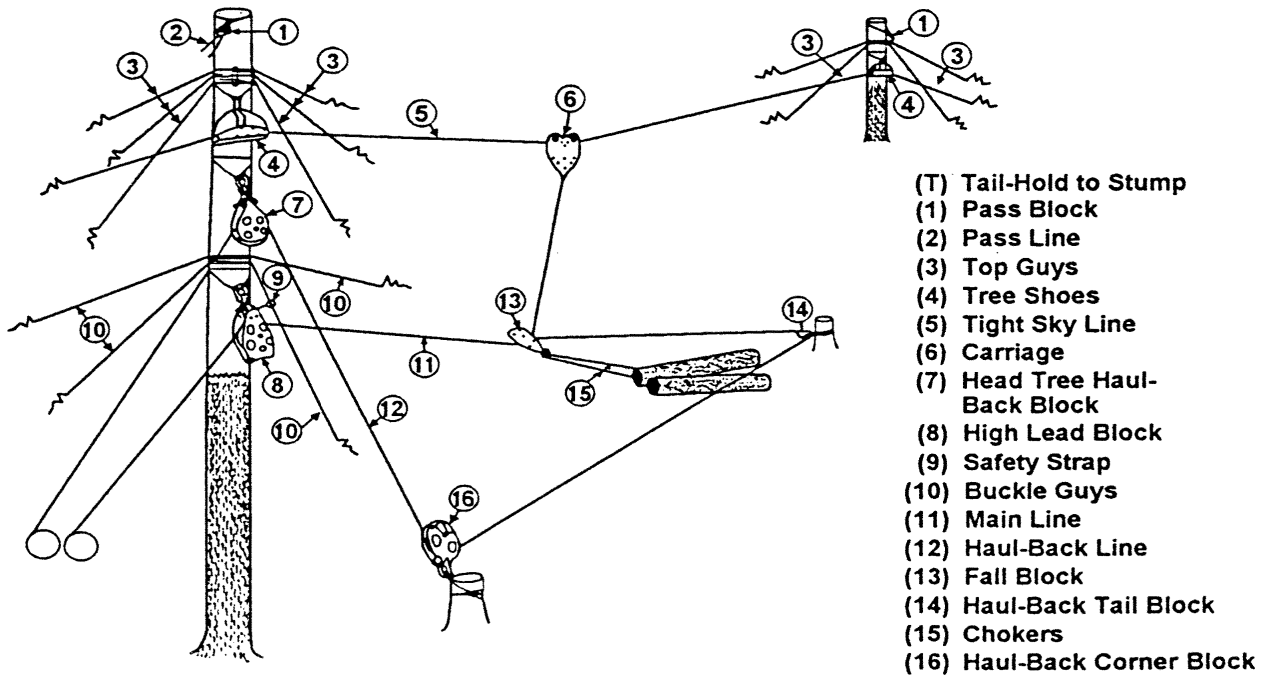
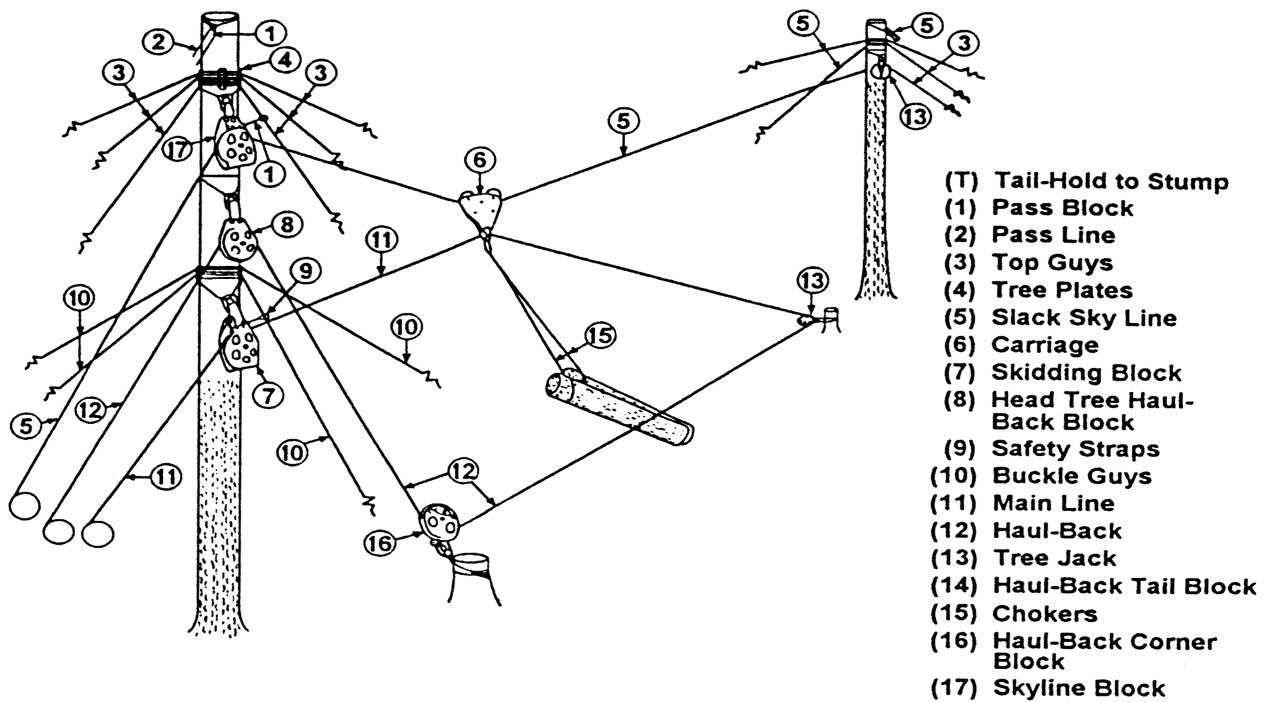

Figure 59: High Lead Yarding System



NORTH BEND YARDING SYSTEM

Figure 60: North Bend Yarding System



SLACK SKYLINE YARDING SYSTEM
 Figure 61: Slack Skyline Yarding System

Heel Boom Loading

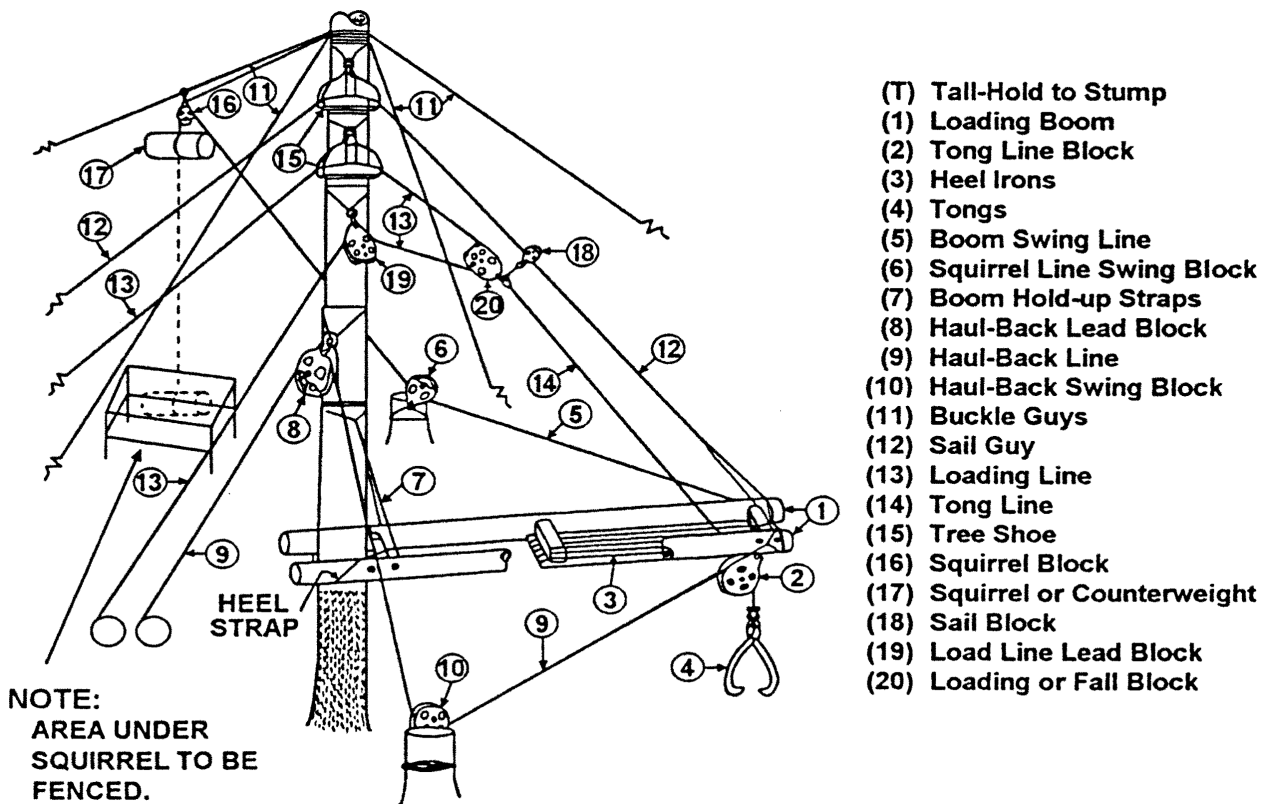

Figure 62: Heel Boom Loading

GUY LINE LOADING

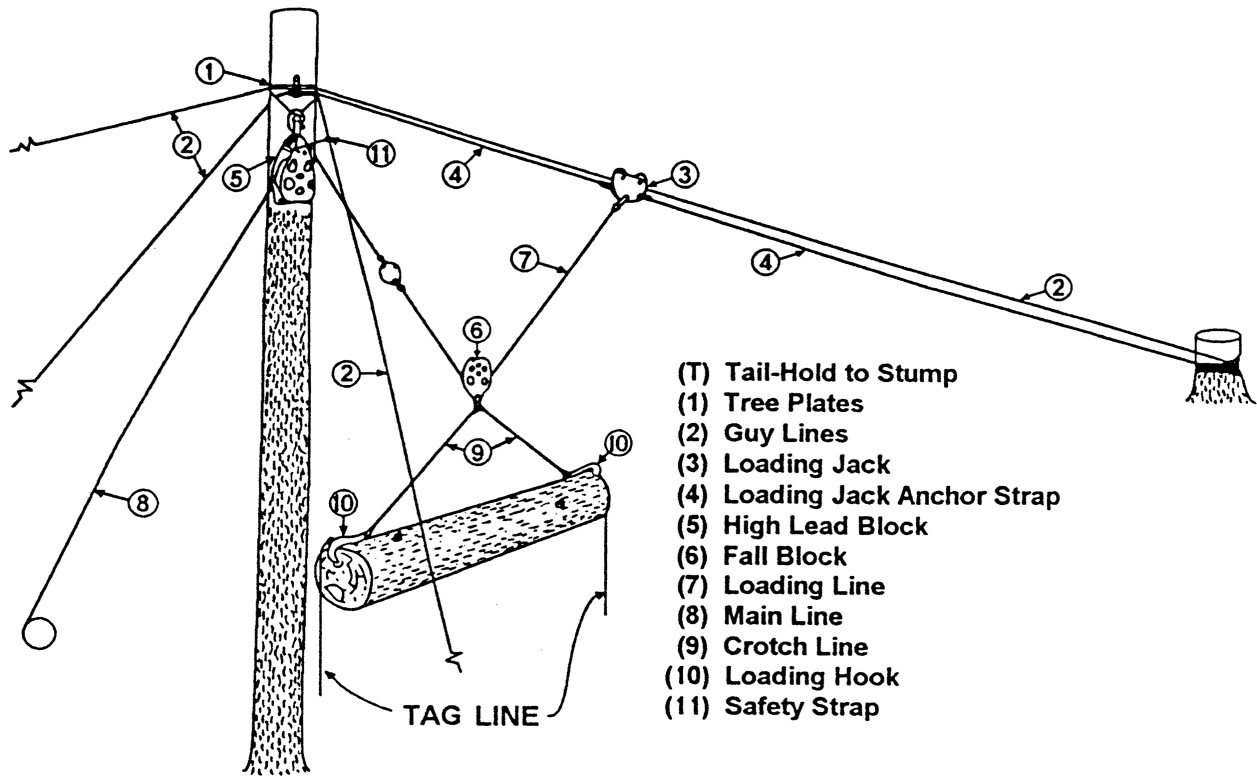

Figure 63: Guy Line Loading

HAYRACK BOOM LOADING

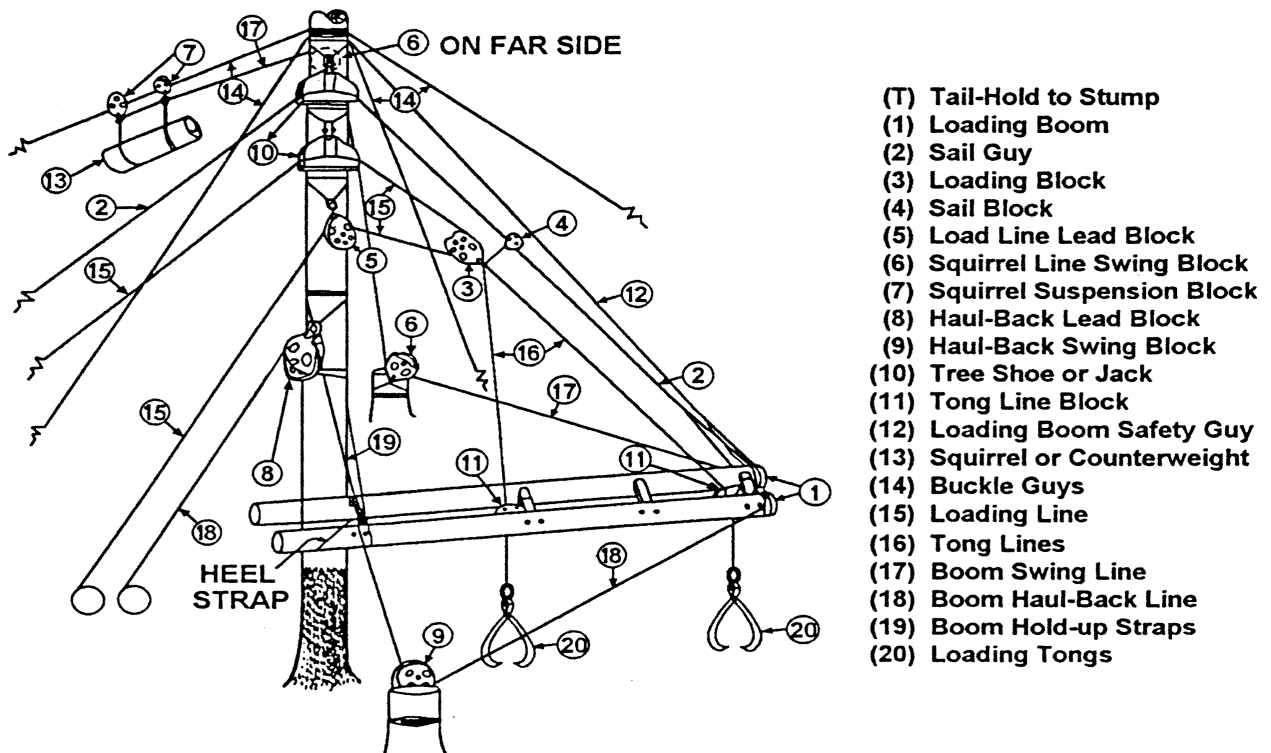
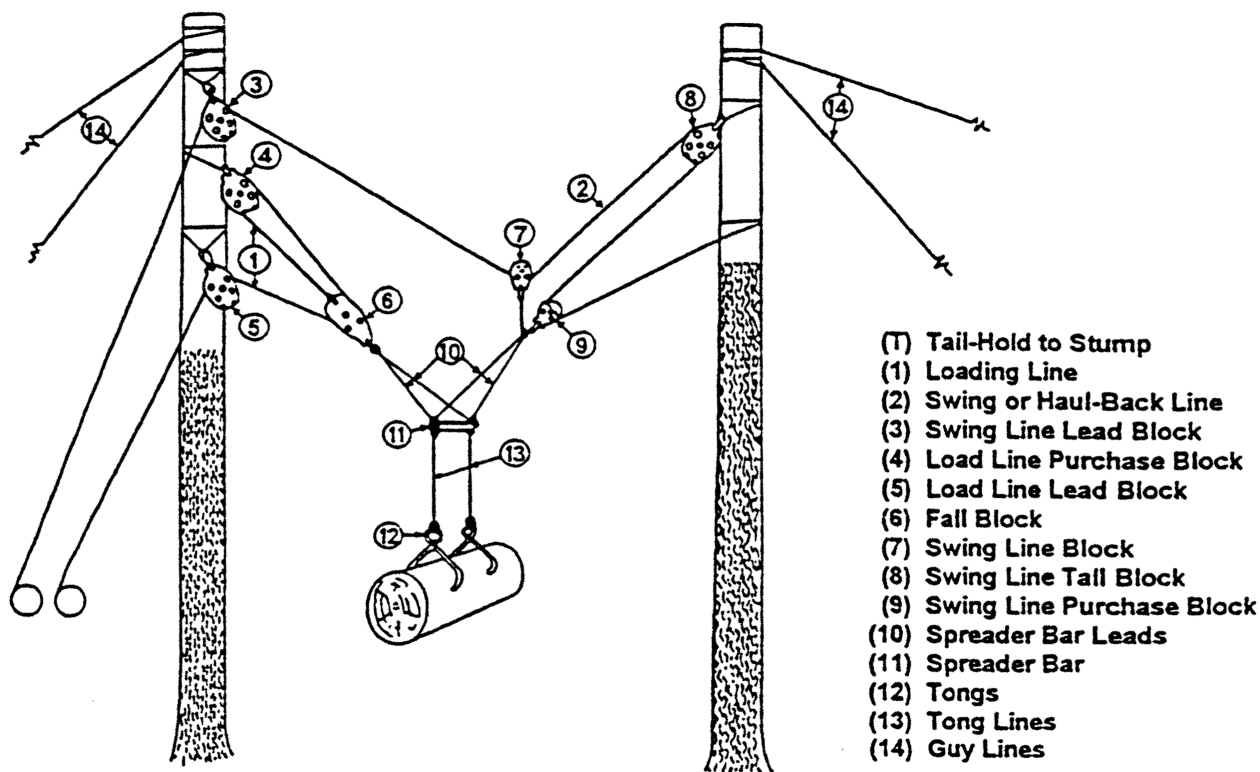

Figure 64: Hayrack Boom Loading



SPREADER BAR LOADING

Figure 65: Spreader Bar Loading

[Statutory Authority: RCW 49.17.010, [49.17].040 and [49.17].050. WSR 99-17-117, § 296-54-99014, filed 8/18/99, effective 12/1/99.]

WAC 296-54-99015 Appendix 6—Sample chain shot training program.

"Chain Shot" Awareness and Prevention Training

Employee _____ Trainer _____ Date _____

All employees who operate or work around or perform maintenance and/or repair of any kind of machinery equipped with a hydraulic powered bar saw must receive "chain shot" awareness training appropriate to their job.

Note: Employers who have employees who are potentially exposed to the chain shot but do not operate, inspect, or maintain the equipment can limit training to the information in Section 1.

Indicates that the employee has received training.

Section 1 General information

- Chain shot is the high velocity separation and ejection of a piece or pieces of cutting chain from the end of a broken chain in mechanized timber harvesting/processing. Chain shot exposes both machine operators and bystanders to a risk of serious injury or death. Chain shot typically occurs near the drive end of the cutting system but can also come from the bar tip area.

- A chain shot consists of two breaks in a chain. First, the loop of chain breaks and forms two ends. One end moves past the drive sprocket or bar nose and is rapidly accelerated due to a whip-like motion of the chain end. The "whip action" causes the second break releasing small parts at extremely high speed.
- The "shot cone zone" is the area along the plane of the guide bar where pieces of a broken chain usually travel unless pieces are deflected. The SCZ angles out approximately at a 15 degree angle on both sides of the guide bar and a distance that possibly exceeds 250 feet.
- Employees should stay clear of the shot cone zone.

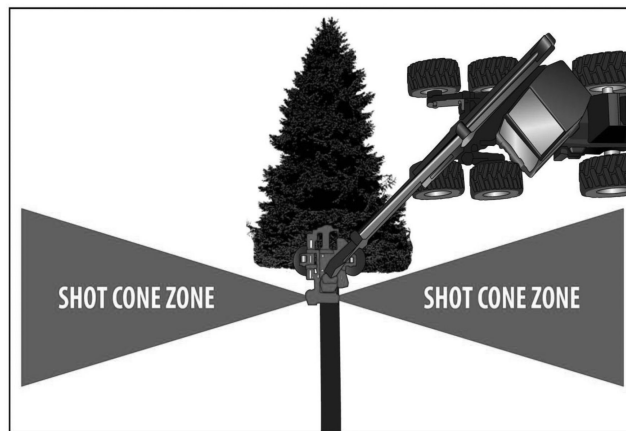

□ Section 2 Cutting system inspection

The cutting system must be inspected before initial use during each work shift. Defective parts that would make the cutting system unsafe to operate, must be replaced or repaired before the cutting system is placed in service. Report unsafe conditions to your supervisor.

Inspections must include:

- The lubrication system for leaks or damage.
- The chain for cracks or worn/damaged parts.
- The bar for wear and straightness and ensure the tip is properly secured.
- The sprocket.
- The chain catcher if equipped.
- The chain shot guard if equipped.

□ Section 3 Cutting system maintenance

- Sharpen, assemble and repair chains in accordance with the manufacturer's specifications.
- Maintain proper bar and chain lubrication, making sure to use the right type and amount of lubricant.
- Replace the drive sprocket when it has excessive wear.
- Clean guide bar grooves and oil port holes regularly.
- Guidebars should be flipped regularly to ensure even wear.

□ Section 4 Cutting system operation

- The operator and other persons should be kept clear of the shot cone zone.
- Follow chain manufacturer's recommendations for chain speed. "Boosting" or exceeding the recommended chain speed is prohibited.
- Maintain proper chain tension.

[Statutory Authority: RCW 49.17.010, 49.17.040, 49.17.050, 49.17.060, and chapter 49.17 RCW. WSR 17-17-131, § 296-54-99015, filed 8/22/17, effective 10/22/17.]